

## FILLABLE PDF ORDER FORM USAGE INSTRUCTIONS

For your convenience and processing efficiency, this order form contains fillable pdf fields that can be filled in electronically via **Adobe® Acrobat®** or **Adobe® Reader®** and then saved, printed and/or submitted to our Customer Service team for order or quote processing.

Please follow the following steps to complete this form\* electronically based on the Adobe software you currently have on your operating system.

[Click here](#) to download Adobe Reader for free or to purchase Adobe Acrobat software.

### USERS WITH **ADOBE ACROBAT**

#### TO SAVE ELECTRONIC COPY:

1. Fill out the order form completely
2. In the top navigation menu, go to FILE, then SAVE AS
3. Rename the file and select the destination where you'd like the file saved and save

#### TO SUBMIT FOR ORDER OR QUOTE:

1. Follow instructions above for saving a copy of the file
2. Click on the "Submit" button at the top of the first page of the completed and saved order form.
3. This action will open up a pop-up asking you to select your E-mail client. Select which one is applicable to you and then OK. (See figure 1)
4. The next pop-up will ask you if you want to send a data file or print the form. Select SEND DATA FILE (See figure 2)
5. An e-mail message will pop up with the order form as an attachment.
6. You may want to copy yourself to keep as a record
7. Send e-mail.

Figure 1

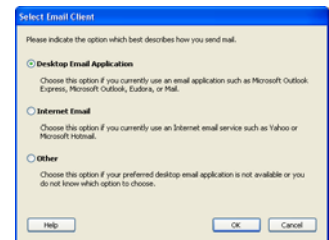
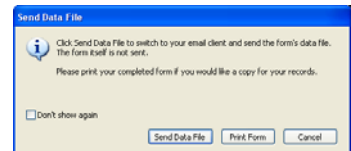

Figure 2



### USERS WITH **ADOBE READER**

#### TO SAVE ELECTRONIC COPY:

1. Fill out the order form completely (Please note that you will **not** be able to make any additional changes once the order form is saved).
2. In the top navigation menu, go to FILE, then PRINT
3. Select Adobe PDF from your list of printers and print the file
4. Select the destination where you would like the file saved, rename the file and save

#### TO SUBMIT FOR ORDER OR QUOTE:

1. Follow the document saving instructions listed above
2. Attach your saved file to an e-mail and send to the following e-mail box: [orders@sunmed.com](mailto:orders@sunmed.com)

*\*Please note that this order forms fillable fields are not programmed with logic and the fields will not prevent you from selecting options that are no-go's so please review the footnotes carefully. Sunrise Medical does offer an online product configurator that's programmed with all no-go information. To complete an order on the configurator, please visit [www.sunrisemedical.com](http://www.sunrisemedical.com) and log-in to your dealer account.*



## JAY<sup>®</sup> Zip Pediatric Backrest October 2012

**Mark For:**
**Submitting for:**
 Quote

 Order

Date: \_\_\_\_\_

PO#: \_\_\_\_\_

Dealer Acct #: \_\_\_\_\_

Dealer: \_\_\_\_\_

Dealer Contact: \_\_\_\_\_

Dealer Address: \_\_\_\_\_

Dealer City: \_\_\_\_\_ ST: \_\_\_\_\_ ZIP: \_\_\_\_\_

Dealer Phone: ( ) \_\_\_\_\_ Fax: ( ) \_\_\_\_\_

Confirmation Email: \_\_\_\_\_

 Confirm Via:  Fax  Email

**ADDITIONAL SHIPPING INFORMATION**

Ship To: \_\_\_\_\_

Attention: \_\_\_\_\_

Address: \_\_\_\_\_

Address: \_\_\_\_\_

Ship To City: \_\_\_\_\_ ST: \_\_\_\_\_ ZIP: \_\_\_\_\_

Ship To Phone: ( ) \_\_\_\_\_ Fax: ( ) \_\_\_\_\_

*The **HCPCS CODES** provided are based on code verification through PDAC or our interpretation of the code definitions.*

*The use of **HCPCS CODES** does not ensure coverage or payment. For coverage information, verify the appropriate payer's coverage policy.*

<input checked="" type="checkbox"/>	Option #	HCPCS	Definition	Price	<input checked="" type="checkbox"/>	Option #	HCPCS	Definition	Price
-------------------------------------	----------	-------	------------	-------	-------------------------------------	----------	-------	------------	-------

### JAY ZIP BACK

 JZIPBXXY E2613 JAY Zip Backrest All Sizes \$495.00

*NOTE: Select appropriate assembly number below.*

*165 lbs Weight Capacity*

**EACH BACK SHIPS WITH THE FOLLOWING:**

- Ultra lightweight mounting hardware
- 1.6" of anterior depth adjustment, 3" with reversing hardware provided
- 10mm Combo Wrench
- Angle Adjustability from -20° to +20°
- Neoprene Backrest Hardware Covers (Allows for quick release)
- Water resistant inner cover & Anti-microbial outer cover
- Adjustable lumbar support

BACKREST WIDTH	8"	10"	12"	14"
FITS BACK CANE WIDTHS	8"-9"	10"-11"	12"-13"	14"-15"
MAX. USER TRUNK WIDTH	7"	9"	11"	13"
DEPTH OF CONTOUR	1"	1.5"	2"	2.5"

		Backrest Width			
		8"	10"	12"	14"
Backrest Height	6" (S)	<input type="checkbox"/> JZIPB08S	<input type="checkbox"/> JZIPB10S	<input type="checkbox"/> JZIPB12S	<input type="checkbox"/> JZIPB14S
	8" (M)	<input type="checkbox"/> JZIPB08M	<input type="checkbox"/> JZIPB10M	<input type="checkbox"/> JZIPB12M	<input type="checkbox"/> JZIPB14M
	10" (T)	<input type="checkbox"/> JZIPB08T	<input type="checkbox"/> JZIPB10T	<input type="checkbox"/> JZIPB12T	<input type="checkbox"/> JZIPB14T
	12" (X)	<input type="checkbox"/> JZIPB08X	<input type="checkbox"/> JZIPB10X	<input type="checkbox"/> JZIPB12X	<input type="checkbox"/> JZIPB14X

*The JAY ZIP Backrest has been dynamically tested and meets all criteria for use in motor vehicles according to Section 5.1 of ISO 16840-4 and Section 20, ANSI/RESNA WC/Volume 4.*

*Please visit [www.sunparts.us](http://www.sunparts.us) for spare parts information.*

**JAY ZIP BACK ACCESSORIES**

JAY ZIP Back accessories are optional. All accessories will be factory mounted as much as possible to insure proper shipping.

**LATERAL SUPPORTS**

Use this section for lateral supports.

**FIXED LATERAL THORACIC SUPPORT**

Includes fixed mounting hardware.

<input type="checkbox"/>	JZFX34F	E0956	LAT ZIP FIXED 3X4 FLAT	\$250.00	<input type="checkbox"/>	JZFX34C	E0956	LAT ZIP FIXED 3X4 CURVE	\$260.00
<input type="checkbox"/>	JZFX45F	E0956	LAT ZIP FIXED 4X5 FLAT	\$250.00	<input type="checkbox"/>	JZFX45C	E0956	LAT ZIP FIXED 4X5 CURVE	\$260.00

**SWING-AWAY LATERAL THORACIC SUPPORT**

Includes swing-away mounting hardware and all laterals are sold in pairs.

<input type="checkbox"/>	<b>JZSA34F</b>		<b>LAT 3X4 FLAT W/ S/A MOUNT</b>	<b>\$775.00</b>	<input type="checkbox"/>	<b>JZSA34CO</b>		<b>LAT 3X4 CRV 1" OFF W/ S/A MNT</b>	<b>\$785.00</b>
	JZ34F	E0956	LAT ZIP 3X4 FLAT	\$250.00		JZ34CO	E0956	LAT 3X4 CURVE W/ 1" OFFSET	\$260.00
	JZSAMNT	E1028	LATERAL SWING AWAY MOUNT	\$525.00		JZSAMNT	E1028	LATERAL SWING AWAY MOUNT	\$525.00
<input type="checkbox"/>	<b>JZSA45F</b>		<b>LAT 4X5 FLAT W/ S/A MOUNT</b>	<b>\$775.00</b>	<input type="checkbox"/>	<b>JZSA45CO</b>		<b>LAT 4X5 CRV 1" OFF W/ S/A MNT</b>	<b>\$785.00</b>
	JZ45F	E0956	LAT ZIP 4X5 FLAT	\$250.00		JZ45CO	E0956	LAT 4X5 CURVE W/ 1IN OFFSET	\$260.00
	JZSAMNT	E1028	LATERAL SWING AWAY MOUNT	\$525.00		JZSAMNT	E1028	LATERAL SWING AWAY MOUNT	\$525.00
<input type="checkbox"/>	<b>JZSA34C</b>		<b>LAT 3X4 CURVE W/ S/A MOUNT</b>	<b>\$785.00</b>	<input type="checkbox"/>	<b>JZSA34FOA</b>		<b>LAT 3X4 FLAT ADJ 1" OFF W/ S/A</b>	<b>\$780.00</b>
	JZ34C	E0956	LAT ZIP 3X4 CURVE	\$260.00		JZ34FOA	E0956	LAT 3X4 FLAT W/ ADJ 1" OFFSET	\$255.00
	JZSAMNT	E1028	LATERAL SWING AWAY MOUNT	\$525.00		JZSAMNT	E1028	LATERAL SWING AWAY MOUNT	\$525.00
<input type="checkbox"/>	<b>JZSA45C</b>		<b>LAT 4X5 CURVE W/ S/A MOUNT</b>	<b>\$785.00</b>	<input type="checkbox"/>	<b>JZSA45FOA</b>		<b>LAT 4X5 FLAT ADJ 1" OFF W/ S/A</b>	<b>\$780.00</b>
	JZ45C	E0956	LAT ZIP 4X5 CURVE	\$260.00		JZ45FOA	E0956	LAT 4X5 FLAT W/ ADJ 1" OFFSET	\$255.00
	JZSAMNT	E1028	LATERAL SWING AWAY MOUNT	\$525.00		JZSAMNT	E1028	LATERAL SWING AWAY MOUNT	\$525.00
<input type="checkbox"/>	<b>JZSA34FO</b>		<b>LAT 3X4 FLT 1" OFF W/ S/A MNT</b>	<b>\$775.00</b>	<input type="checkbox"/>	<b>JZSA34COA</b>		<b>LAT 3X4 CRV ADJ 1" OFF W/ S/A</b>	<b>\$790.00</b>
	JZ34FO	E0956	LAT ZIP 3X4 FLAT W/ 1" OFFSET	\$250.00		JZ34COA	E0956	LAT 3X4 CRV W/ ADJ 1" OFFSET	\$265.00
	JZSAMNT	E1028	LATERAL SWING AWAY MOUNT	\$525.00		JZSAMNT	E1028	LATERAL SWING AWAY MOUNT	\$525.00
<input type="checkbox"/>	<b>JZSA45FO</b>		<b>LAT 4X5 FLT 1" OFF W/ S/A MNT</b>	<b>\$775.00</b>	<input type="checkbox"/>	<b>JZSA45COA</b>		<b>LAT 4X5 CRV ADJ 1" OFF W/ S/A</b>	<b>\$790.00</b>
	JZ45FO	E0956	LAT ZIP 4X5 FLAT W/ 1" OFFSET	\$250.00		JZ45COA	E0956	LAT 4X5 CRV W/ ADJ 1" OFFSET	\$265.00
	JZSAMNT	E1028	LATERAL SWING AWAY MOUNT	\$525.00		JZSAMNT	E1028	LATERAL SWING AWAY MOUNT	\$525.00

**LATERAL MEASURING GUIDE (Fixed and Swing Away)**

**NEW!**

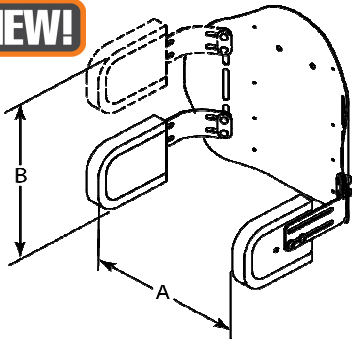

DIM	Description	Back Width			
		8" Wide	10" Wide	12" Wide	14" Wide
A	<b>Lateral Adjustment Range</b> (Min Spacing - Max Spacing)	3.8" - 4.8"	5.1" - 6.1"	6.8" - 7.8"	8.4" - 9.4"
B	<b>Lateral Height Range</b> (Measured from bottom edge of shell to top of lateral)	6" Tall Back	Not Available		
		8" Tall Back	7"		
		10" Tall Back	9"		
		12" Tall Back	10"		

**HEADRESTS**

<input type="checkbox"/>	<b>JZHED6</b>		<b>Headrest w/ Pad - 6" Plush</b>	<b>\$381.00</b>
	JPLSH06	E0955	Pad - 6" Plush	\$161.00
	JZIPBHH	E1028	Onyx post w/ Axys Hardware	\$220.00
<input type="checkbox"/>	<b>JZHED8</b>		<b>Headrest w/ Pad - 8" Plush</b>	<b>\$381.00</b>
	JPLSH08	E0955	Pad - 8" Plush	\$161.00
	JZIPBHH	E1028	Onyx post w/ Axys Hardware	\$220.00
<input type="checkbox"/>	<b>JZHEDCINF</b>		<b>Headrest w/ Pad - 6" Contoured</b>	<b>\$363.00</b>
	JCNTR06	E0955	Pad - 6" Contoured Cradle	\$143.00
	JZIPBHH	E1028	Onyx post w/ Axys Hardware	\$220.00
<input type="checkbox"/>	<b>JZHEDCS</b>		<b>Headrest w/ Pad - 8" Contoured</b>	<b>\$363.00</b>
	JCNTR08	E0955	Pad - 8" Contoured Cradle	\$143.00
	JZIPBHH	E1028	Onyx post w/ Axys Hardware	\$220.00

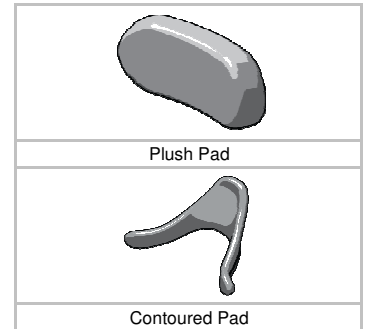
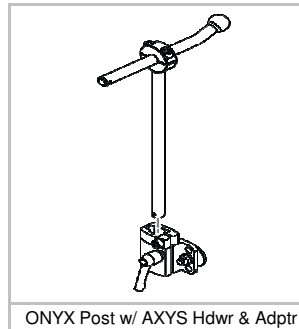







**VANITY FLAP**

Vanity flaps are NOT INCLUDED as a standard option with the JAY ZIP Back.

<input type="checkbox"/>	VF08	K0108	8" to 9" Wide	\$45.00	<input type="checkbox"/>	VF12	K0108	12" to 13" Wide	\$45.00
<input type="checkbox"/>	VF10	K0108	10" to 11" Wide	\$45.00	<input type="checkbox"/>	VF14	K0108	14" to 15" Wide	\$45.00

**SPINE ALIGN POSITIONING COMPONENTS**

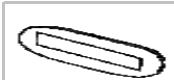
<input type="checkbox"/>	J3SPNCR	K0108	Curved Shim	\$25.00	<input type="checkbox"/>	J3SPNBL	K0108	Large Bean Bag	\$29.00
<input type="checkbox"/>	J3SPNBS	K0108	Small Bean Bag	\$27.00	<input type="checkbox"/>	J3SPNLS	K0108	Lateral Shim	\$47.00
<input type="checkbox"/>	J3SPNFL	K0108	Flat Shim	\$25.00	<input type="checkbox"/>	J3SPNLP	K0108	Posterior/Lateral Pelvic	\$47.00

						
	<b>Curved Slim</b>	<b>Flat</b>	<b>Lateral Slim</b>	<b>Sm Bean Bag</b>	<b>Lg Bean Bag</b>	<b>Post/Lat Pelvic</b>
<b>W</b>	10"	10"	2.4"	6"	10"	5.3"
<b>H</b>	4"	4"	4.3"	4.5"	3.2"	3.6"
<b>D</b>	0.5"	0.3"	0.5"	0.75"	0.75"	0.75"

**CHEST STRAPS & HARNESES**

*Chest Straps & Harnesses include guide brackets and hardware.*

<input type="checkbox"/>	JZ9407	E0960	Center Opening w/ Buckle (EI)	\$160.00	<input type="checkbox"/>	JZ9107	E0960	Contoured - Dynamic Pull Down (EI)	\$160.00
<input type="checkbox"/>	JZ9400	E0960	Center Opening w/ Buckle (XS)	\$160.00	<input type="checkbox"/>	JZ9100	E0960	Contoured - Dynamic Pull Down(XS)	\$160.00
<input type="checkbox"/>	JZ9401	E0960	Center Opening w/ Buckle (S)	\$160.00	<input type="checkbox"/>	JZ9101	E0960	Contoured - Dynamic Pull Down (S)	\$160.00
<input type="checkbox"/>	JZ9402	E0960	Center Opening w/ Buckle (M)	\$160.00	<input type="checkbox"/>	JZ9102	E0960	Contoured - Dynamic Pull Down (M)	\$160.00
<input type="checkbox"/>	JZ8107	E0960	Classic - Dynamic Pull Down (EI)	\$160.00	<input type="checkbox"/>	JZ9300	E0960	Contoured - Strctrd Pull Down (XS)	\$160.00
<input type="checkbox"/>	JZ8100	E0960	Classic - Dynamic Pull Down (XS)	\$160.00	<input type="checkbox"/>	JZ9301	E0960	Contoured - Strctrd Pull Down (S)	\$160.00
<input type="checkbox"/>	JZ8101	E0960	Classic - Dynamic Pull Down (S)	\$160.00	<input type="checkbox"/>	JZ9302	E0960	Contoured - Strctrd Pull Down (M)	\$160.00
<input type="checkbox"/>	JZ8102	E0960	Classic - Dynamic Pull Down (M)	\$160.00	<input type="checkbox"/>	JZ4050	E0960	Padded Anterior Trunk Straps (XS)	\$150.00
<input type="checkbox"/>	JZ8300	E0960	Classic - Structured Pull Down (XS)	\$160.00	<input type="checkbox"/>	JZ4000	E0960	Padded Anterior Trunk Straps (S)	\$150.00
<input type="checkbox"/>	JZ8301	E0960	Classic - Structured Pull Down (S)	\$160.00	<input type="checkbox"/>	JZ4100	E0960	Padded Anterior Trunk Straps (M)	\$150.00
<input type="checkbox"/>	JZ8302	E0960	Classic - Structured Pull Down (M)	\$160.00					

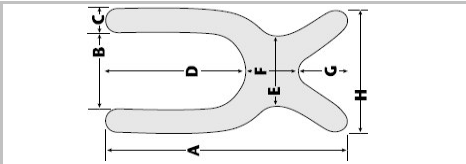
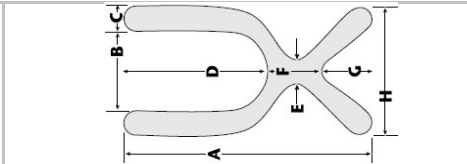
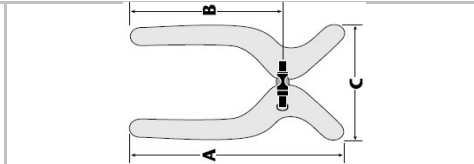
																																																																																																																
Classic Style	Contour Style	Center-Opening with Buckle																																																																																																														
<table border="1"> <tr><th></th><th>A</th><th>B</th><th>C</th><th>D</th><th>E</th><th>F</th><th>G</th><th>H</th></tr> <tr><td>EI</td><td>9.8"</td><td>3"</td><td>2"</td><td>5.3"</td><td>3"</td><td>3"</td><td>1"</td><td>6.5"</td></tr> <tr><td>XS</td><td>12.5"</td><td>3.5"</td><td>2"</td><td>7.5"</td><td>3.5"</td><td>3"</td><td>2"</td><td>7.5"</td></tr> <tr><td>S</td><td>15"</td><td>4.5"</td><td>2"</td><td>9"</td><td>4"</td><td>4"</td><td>2"</td><td>8.5"</td></tr> <tr><td>M</td><td>19"</td><td>5.5"</td><td>2"</td><td>11"</td><td>5"</td><td>5"</td><td>3"</td><td>9.5"</td></tr> </table>		A	B	C	D	E	F	G	H	EI	9.8"	3"	2"	5.3"	3"	3"	1"	6.5"	XS	12.5"	3.5"	2"	7.5"	3.5"	3"	2"	7.5"	S	15"	4.5"	2"	9"	4"	4"	2"	8.5"	M	19"	5.5"	2"	11"	5"	5"	3"	9.5"	<table border="1"> <tr><th></th><th>A</th><th>B</th><th>C</th><th>D</th><th>E</th><th>F</th><th>G</th><th>H</th></tr> <tr><td>EI</td><td>9.8"</td><td>3"</td><td>1.8"</td><td>5.3"</td><td>1"</td><td>3.5"</td><td>1.5"</td><td>6.5"</td></tr> <tr><td>XS</td><td>12.5"</td><td>3.5"</td><td>2"</td><td>7.5"</td><td>1"</td><td>3.5"</td><td>1.5"</td><td>7.5"</td></tr> <tr><td>S</td><td>15"</td><td>4.5"</td><td>2"</td><td>9"</td><td>1"</td><td>4"</td><td>2"</td><td>8.5"</td></tr> <tr><td>M</td><td>18.5"</td><td>5.5"</td><td>2"</td><td>11"</td><td>1"</td><td>5"</td><td>2.5"</td><td>9.5"</td></tr> </table>		A	B	C	D	E	F	G	H	EI	9.8"	3"	1.8"	5.3"	1"	3.5"	1.5"	6.5"	XS	12.5"	3.5"	2"	7.5"	1"	3.5"	1.5"	7.5"	S	15"	4.5"	2"	9"	1"	4"	2"	8.5"	M	18.5"	5.5"	2"	11"	1"	5"	2.5"	9.5"	<table border="1"> <tr><th></th><th>A</th><th>B</th><th>C</th></tr> <tr><td>EI</td><td>9.8"</td><td>7"</td><td>5"</td></tr> <tr><td>XS</td><td>11"</td><td>8"</td><td>5.8"</td></tr> <tr><td>S</td><td>12.3"</td><td>9"</td><td>6.5"</td></tr> <tr><td>M</td><td>14.3"</td><td>11"</td><td>9.8"</td></tr> </table>		A	B	C	EI	9.8"	7"	5"	XS	11"	8"	5.8"	S	12.3"	9"	6.5"	M	14.3"	11"	9.8"
	A	B	C	D	E	F	G	H																																																																																																								
EI	9.8"	3"	2"	5.3"	3"	3"	1"	6.5"																																																																																																								
XS	12.5"	3.5"	2"	7.5"	3.5"	3"	2"	7.5"																																																																																																								
S	15"	4.5"	2"	9"	4"	4"	2"	8.5"																																																																																																								
M	19"	5.5"	2"	11"	5"	5"	3"	9.5"																																																																																																								
	A	B	C	D	E	F	G	H																																																																																																								
EI	9.8"	3"	1.8"	5.3"	1"	3.5"	1.5"	6.5"																																																																																																								
XS	12.5"	3.5"	2"	7.5"	1"	3.5"	1.5"	7.5"																																																																																																								
S	15"	4.5"	2"	9"	1"	4"	2"	8.5"																																																																																																								
M	18.5"	5.5"	2"	11"	1"	5"	2.5"	9.5"																																																																																																								
	A	B	C																																																																																																													
EI	9.8"	7"	5"																																																																																																													
XS	11"	8"	5.8"																																																																																																													
S	12.3"	9"	6.5"																																																																																																													
M	14.3"	11"	9.8"																																																																																																													

**JAY YOUR WAY MODIFICATIONS**

*Note: To order options offered via JAY Your Way add a "M" to the front of the part number and follow the prompts.*

*For additional modifications visit [www.sunrisemedical.com](http://www.sunrisemedical.com) to view even more!*

**COVER COLOR OPTIONS - Rear Center Flap**

<input type="checkbox"/>	COCP1	Pink Semi Stretch Cover	NC
<input type="checkbox"/>	COCB	Blue Semi Stretch Cover	NC
<input type="checkbox"/>	COCPU	Purple Cover	NC
<input type="checkbox"/>	COCR	Red Cover	NC
<input type="checkbox"/>	COCB	Toxic Green Cover	NC

**SPINAL FLUID PAD**

<input type="checkbox"/>	SFPS	Small Spinal Fluid Pad	\$50.00
<input type="checkbox"/>	SFPM	Medium Spinal Fluid Pad	\$50.00

**Don't see the option you want? NO PROBLEM! Write your request below and we can evaluate it and provide a quote.**

**CUSTOM EMBROIDERY**

<input type="checkbox"/>	EMBROIDERY	K0108	Embroidery (32 Character Max)	\$22.00
			Location: <input type="checkbox"/> Front	
			Font: <input type="checkbox"/> Block <input type="checkbox"/> Script	

**Embroidery Text:**

**Notes:**

