









Assembly Instructions For **WB1586** (E) 12/11

	
x 17	x 1
A	B

							
EXTRA	x 5	x 1	x 1	x 1	x 1	x 1	x 1

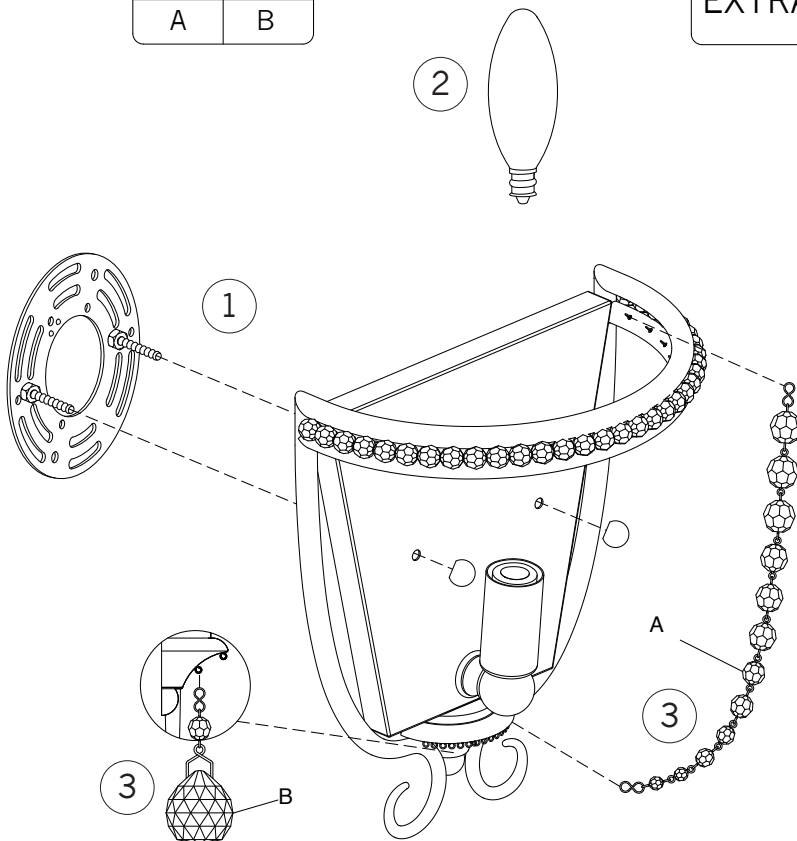

**IMPORTANT
TURN OFF THE POWER AT THE MAIN FUSE
OR CIRCUIT BREAKER BOX
BEFORE STARTING INSTALLATION**

Carefully unpack and identify all parts before assembly. Bulbs not included.

1. Follow enclosed supplement installation instructions for electrical and fixture installation onto house outlet box. If you do not have an outlet box at desired location to attach the fixture then hire a qualified electrician to create one.
2. Install light bulb (not included). See relamping label at socket area for type and maximum allowed wattage.
3. Hang all crystal glass parts as shown on drawing.

NOTE: To replace broken crystal or pin, extras are included in hardware bag. Replace by gently bending open pin, remove broken crystal or pin, hook new one, then close back pin. Avoid bending pin into sharp angle.