







Assembly Instructions For

WB1445 (E) 5/09

| | 1 | 2 | 3 | 4 |
|----------|---|---|---|---|
| |  |  |  |  |
| Required | X1 | X12 | X12 | X12 |
| Extra | 1 | 2 | 2 | 2 |

| Extra PIN Qty. | PIN PART | PIN DESCRIPTION |
|----------------|---|--------------------------|
| 4 |  | Rectangular Crystal Hook |
| 8 |  | Small Bead Hook |

IMPORTANT TURN OFF THE POWER AT THE MAIN FUSE OR CIRCUIT BREAKER BOX BEFORE STARTING INSTALLATION

Carefully unpack and identify all parts before assembly. Bulbs not included.

1. Follow enclosed supplement installation instructions for electrical and fixture installation onto house outlet box. If you do not have an outlet box at desired location to attach the fixture than hire a qualified electrician to create one.

2. A. Install candle tube by slipping through sockets.
B. Install type-B, candelabra base, of 60 Watt maximum bulbs (not included).

3. Hang all crystal glass parts as shown on drawing.

NOTE:

- A. For easier installation of crystal chains #3, hook all chains (the end with smaller rectangular crystal) first onto the lower assembly and then proceed to hook onto the middle assembly.
B. For easier installation of crystal chains #4, hook all chains (the end with smaller rectangular crystal) first onto the upper assembly and then proceed to hook onto the middle assembly.
C. To replace broken crystal or pin, extras are included in hardware bag. Replace by gently bending open pin, remove broken crystal or pin, hook new one, then close back pin. Avoid bending pin into sharp angle.

NOTE:
SMALLER
RECTANGULAR
CRYSTAL MUST BE
INSTALLED AT TOP

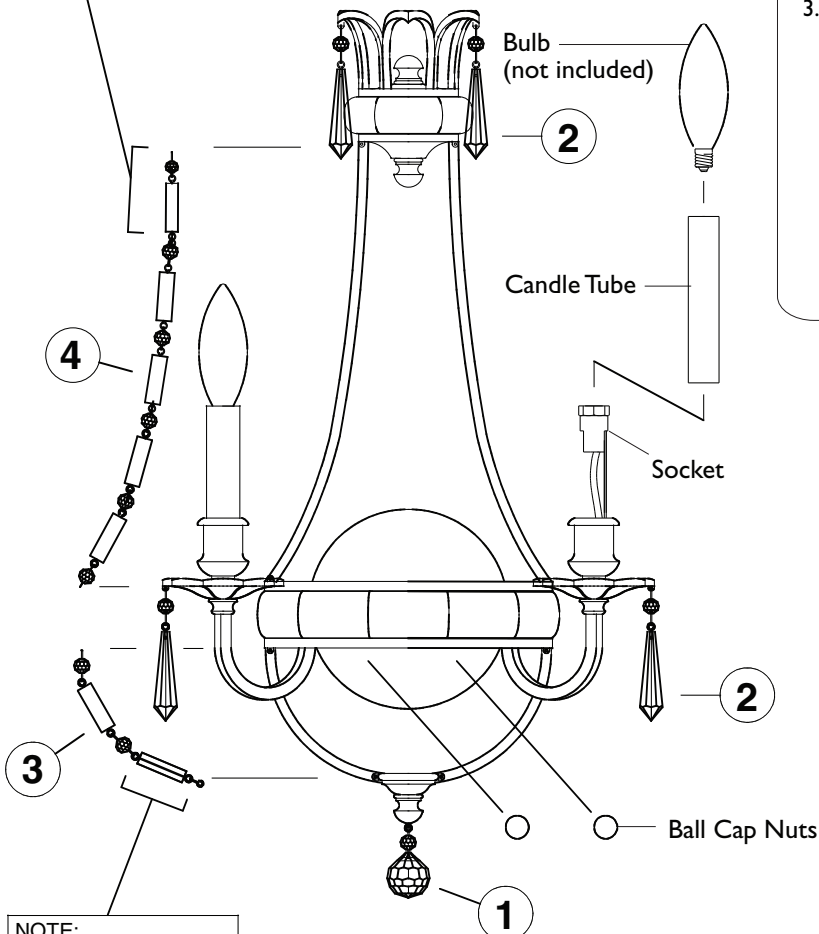

NOTE:
SMALLER
RECTANGULAR
CRYSTAL MUST BE
INSTALLED AT TOP



**MURRAY
FEISS**
Generation Brands™