

H09239 –Mission Computer Desk

Assembly Instructions



For assistance with assembly contact:
Southern Enterprises, Inc.
Customer Service 1-800-633-5096

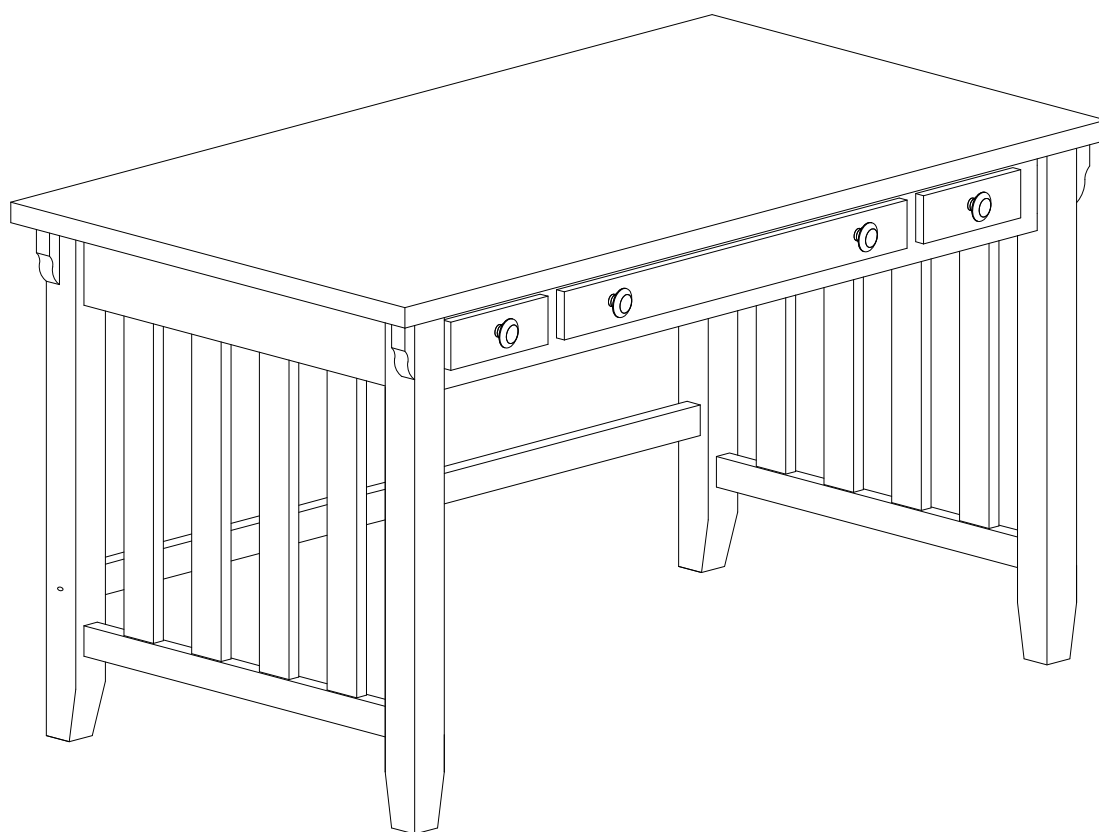

[om](http://www.seidal.com)

www.seidal.com

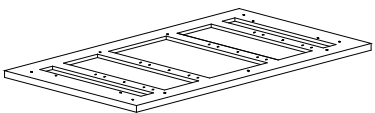
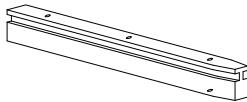

Mission Computer Desk Parts List

Please review all parts and hardware before disposing of any packaging. Call Customer Service if missing hardware. Do not return to store/retailer. Screws shown in actual size. Using a screw that is too long will cause damage. Before beginning assembly, separate each type of screw. Carefully study the screw diagrams below (SHOWN ACTUAL SIZE). You may receive extra hardware with your unit.

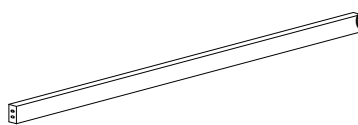
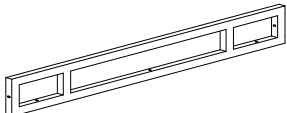
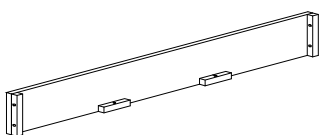
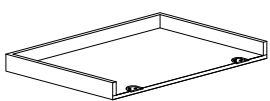
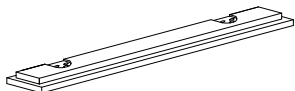
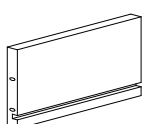
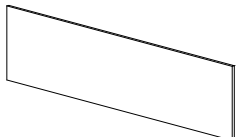
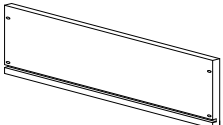
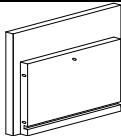
A  Desk Top Quantity of 1	B  Drawer Guide Quantity of 4
C  Right Side Frame Quantity of 1	D  Left Side Frame Quantity of 1
E  Lower Brace Quantity of 1	F  Keyboard Drawer Frame Quantity of 1
G  Upper Brace Quantity of 1	H  Keyboard Drawer Quantity of 1
I  Keyboard Drawer Front Quantity of 1	J  Drawer Back Quantity of 2
K  Drawer Bottom Quantity of 2	L  Drawer Side Quantity of 2
M  Drawer Front Panel Quantity of 2	
Care and Cleaning Instructions: Before using, wipe with a clean, dry cloth. Periodically apply furniture wax to renew the finish. Avoid rubbing or scratching the surface with rough or abrasive objects.	For replacement parts or questions, please Call Customer Service at 1-800-633-5096 Do not return product to store, please call Manufacturer for assistance, questions or Parts.

Assembly Tool Required
No.2 Phillips Screwdriver (Not Included)

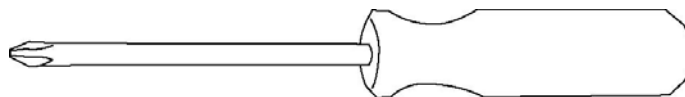

Mission Computer Desk Parts List

Please review all parts and hardware before disposing of any packaging. Call Customer Service if missing hardware. Do not return to store/retailer. Screws shown in actual size. Using a screw that is too long will cause damage. Before beginning assembly, separate each type of screw. Carefully study the screw diagrams below (SHOWN ACTUAL SIZE). You may receive extra hardware with your unit.

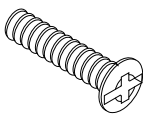
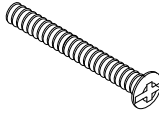
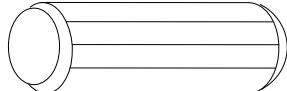
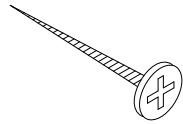
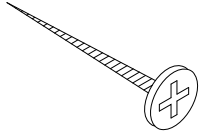
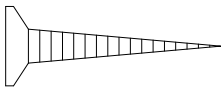
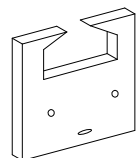
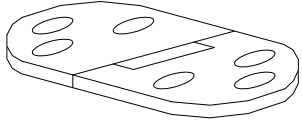
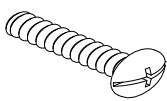
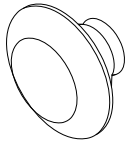
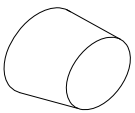
<p>1</p>  <p>Quantity of 15</p> <p>Bolt(1/4"*1-1/8")</p>	<p>2</p>  <p>Quantity of 2</p> <p>Bolt(1/4"*1-3/4")</p>
<p>3</p>  <p>Quantity of 14</p> <p>Wood Dowel</p>	<p>4</p>  <p>Quantity of 12</p> <p>Wood Screw(8#*1-1/4"L)</p>
<p>5</p>  <p>Quantity of 16</p> <p>Wood Screw(6#*3/4"L)</p>	<p>6</p>  <p>Quantity of 24</p> <p>Wood Screw(3*10mmL)</p>
<p>7</p>  <p>Quantity of 4</p> <p>Plastic Drawer Stopper</p>	<p>8</p>  <p>Quantity of 2</p> <p>Hinge</p>
<p>9</p>  <p>Quantity of 4</p> <p>Bolt(5/32"*7/8")</p>	<p>10</p>  <p>Quantity of 4</p> <p>Knob</p>
<p>11</p>  <p>Quantity of 2</p> <p>Wood Plug</p>	

Care and Cleaning Instructions:
Before using, wipe with a clean, dry cloth. Periodically apply furniture wax to renew the finish. Avoid rubbing or scratching the surface with rough or abrasive objects.

For replacement parts or questions, please Call Customer Service at 1-800-633-5096 Do not return product to store, please call Manufacturer for assistance, questions or Parts.

Assembly Tool Required
No.2 Phillips Screwdriver (Not Included)

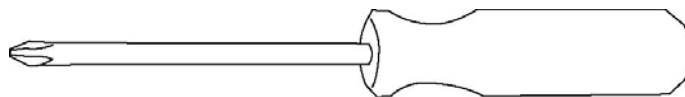

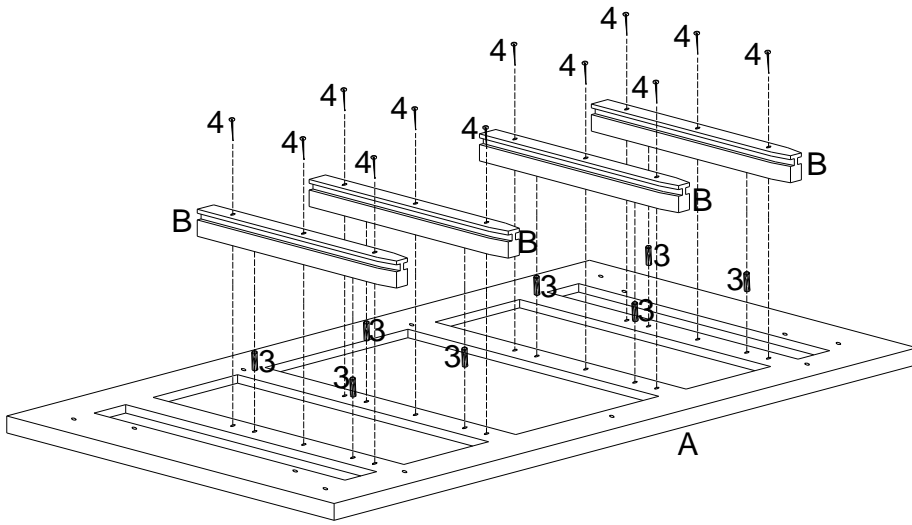

Figure 1

Assembly Instructions:

Wood may scratch easily, Be careful when assembling. Do not scratch.

Step 1 Unpack and lay parts on clean, padded surface like carpet or blanket. Check that you have all parts indicated on the front page.

Step 2 Set the Desk Top (A) upside down on smooth padded surface.

Step 3 Attach the Drawer Guides (B) to the Desk Top (A) with 8pcs Wood Dowels (3) and 12pcs Wood Screws (4) as shown.

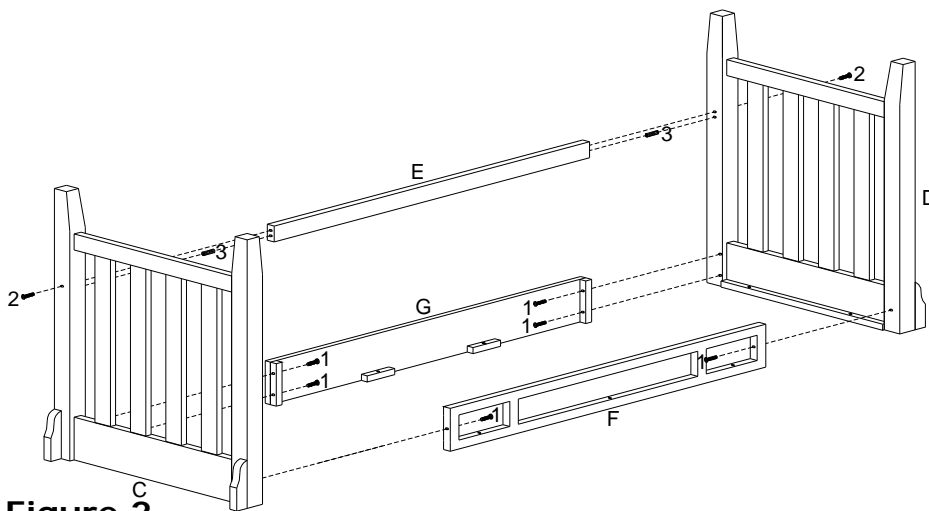

Figure 2

Connect the Upper/Lower Braces (E/G), Keyboard Drawer Frame (F) to the Left/Right Side Frames (C/D) by using 2pcs Wood Dowel (3), 6pcs Bolt (1) and 2pcs Bolt (2) as figure shown.

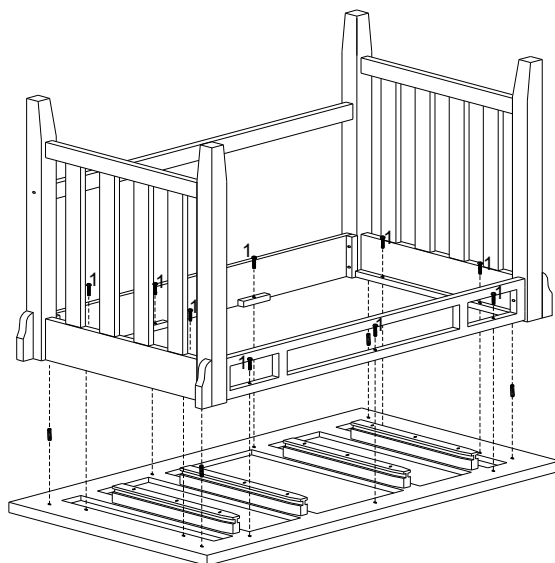

Figure 3

Attach the unit assembled at STEP 2 to the Desk Top (A) with 9pcs Bolt (1) and 4pcs Wood Dowel (3) by using the Screwdriver as figure shown.

Mission Computer Desk Assembly Instructions

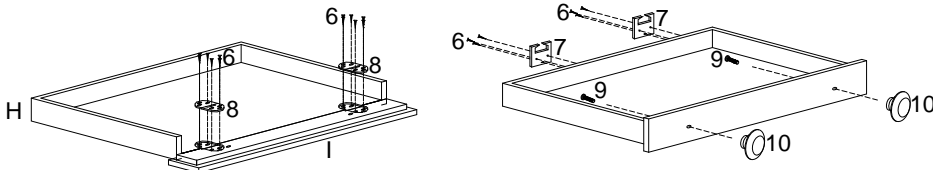

Figure 4

Assemble the Keyboard drawer (H/I) by using 2pcs Hinge (8) and 12pcs Wood Screw (6).

Attach the Plastic Drawer Stoppers (7) to the Drawer with 6pcs Wood Screw (6).

Fix the Knob (10) onto the Keyboard Drawer Front (I) with 2pcs Bolt (9) as figure shown.

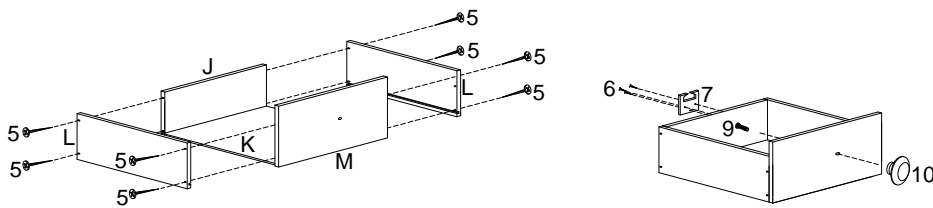

Figure 5

Assemble the drawer (L/J/M/K) by using 8pcs Wood Screw (5).

Attach the Plastic Drawer Stopper (7) to the Drawer with 3pcs Wood Screw (6).

Fix the Knob (10) onto the Drawer Front (M) with 1pc Bolt (9) as figure shown.

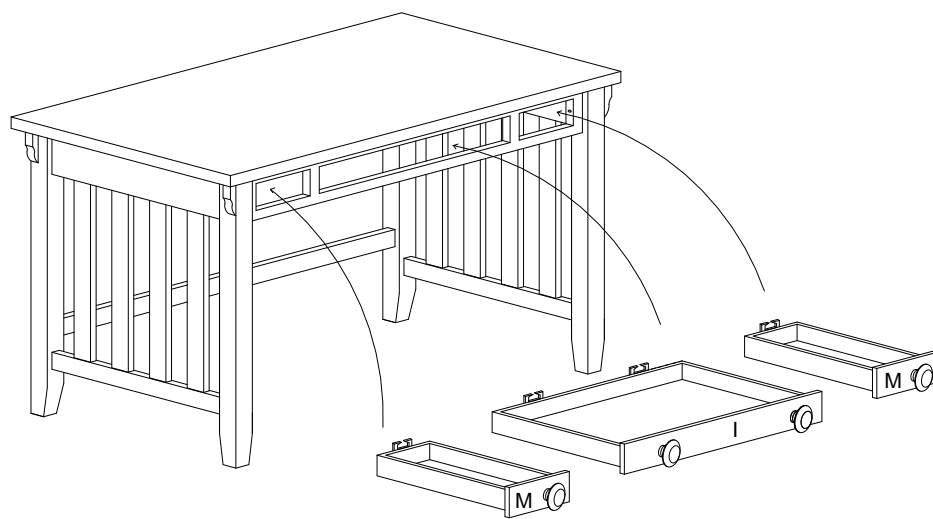

Figure 6

Put the Keyboard Drawer(I) and the Drawer (M) into the right Position.

Mission Computer Desk Assembly Instructions

Insert 2pcs Wood Plugs (11) to
the Side Frames as figure shown.

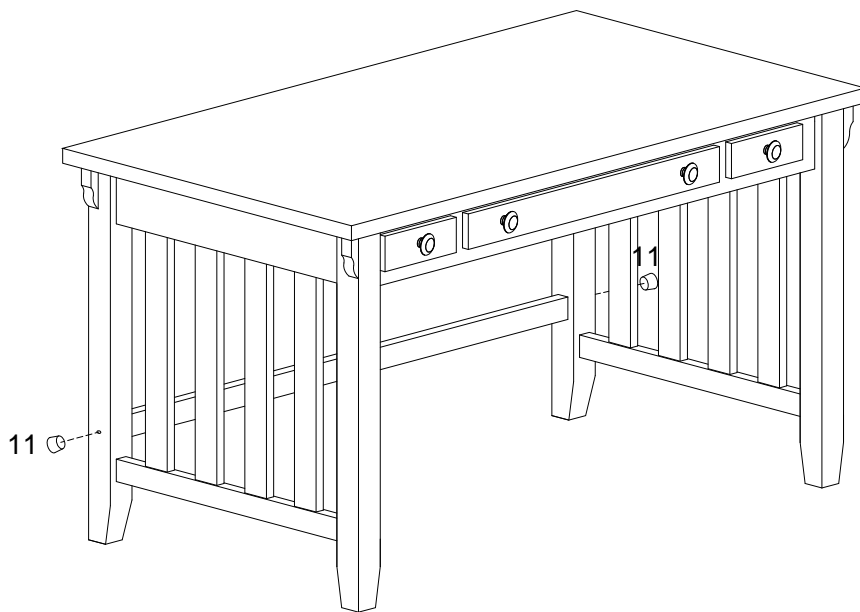

Figure 7



Customer Service 1-800-633-5096

Southern Enterprises, Inc.
2915 Merrell Road
Dallas, Texas 75229

HO9239- Parts Replacement Form

Customer Information

Name _____

Address _____

City/State/Zip Code _____

Phone Number _____

Please indicate where you purchased this item: Store/Website/Catalog

Please indicate color/size/style number:

Style No	Parts Letter	Parts Description	Quantity Needed
----------	--------------	-------------------	-----------------

Missing or damaged hardware and/or parts will be replaced free of charge. We do not sell parts. Southern Enterprises Inc. will provide replacement parts for only those items purchased within the last 9 months. If this product has not been purchased from our retail affiliates (within 9 months), we are under no obligation to provide parts or replacement merchandise. Parts will not be available for items arriving fully assembled.