



# ASSEMBLY INSTRUCTION

## CK122400UT







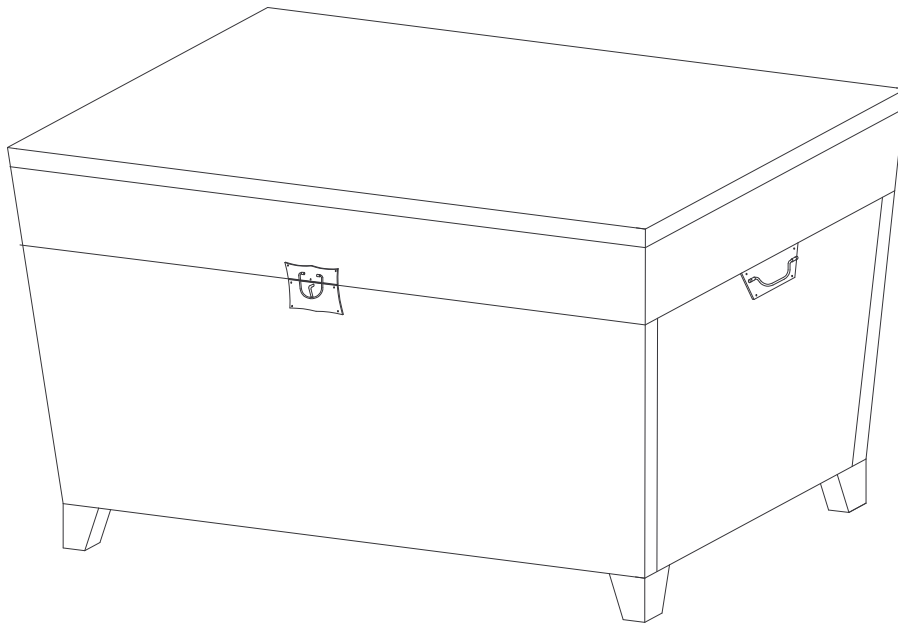

























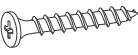











SOUTHERN ENTERPRISES, INC.

RELAX....IF YOU CAN FOLLOW A FEW EASY,



STEP-BY STEP DIRECTIONS IN ORDER, YOU CAN ASSEMBLE THIS ITEM.



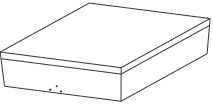
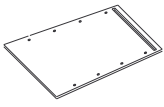
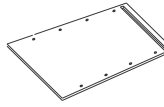
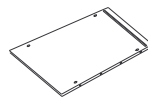
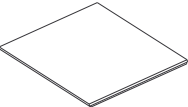

|    |    | DESCRIPTION   | Q'TY  |
|---|---|---|---|
|    |    |    |    |
|    |    |    |    |
|    |    |    |    |
|    |    |    |    |
|    |    |    |    |
|    |    |    |    |
|    |    |    |    |
|    |    |    |    |
|    |    |    |    |
|  |   |    |    |
|  |  |  |  |

## PARTS IDENTIFICATION

|   |  |  |  |
|---|--|--|--|
| <p>① <br/>TOP-1PC</p>              | <p>② <br/>FRONT PANEL-1PC</p> | <p>③ <br/>BACK PANEL-1PC</p> | <p>④ <br/>SIDE PANEL-2PCS</p> |
| <p>⑤ <br/>BOTTOM<br/>PANEL-1PC</p> | <p>⑥ <br/>LEGS-4PCS</p>       |  |  |

# ASSEMBLY INSTRUCTIONS

## STEP-1

Put all parts on a soft surface to prevent scratches, place "H" on the □, tight with "F" "C".

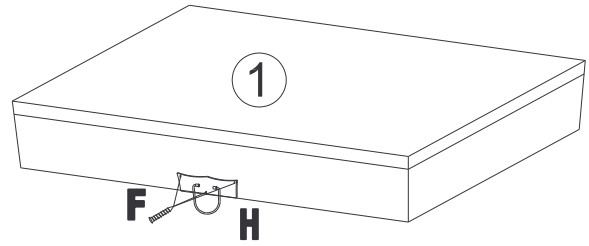

Place "I" on the □, mount tight with "F", "C" as show.

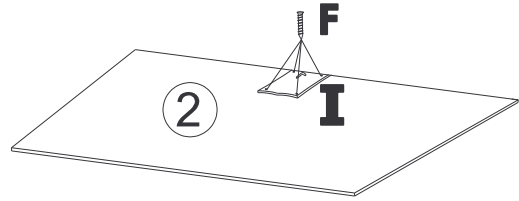

Turn □, mount tight "A" on the □ with "C".

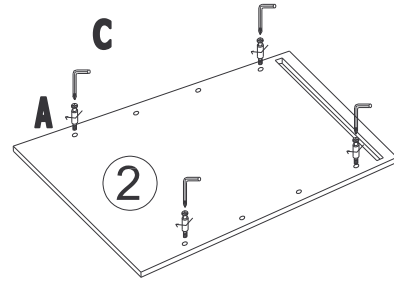

Place "J" on the □, mount tight with "F" "C".

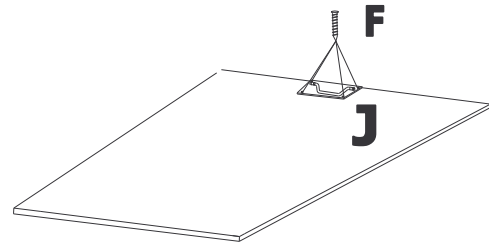

Mount tight "A" on the □ with "C".

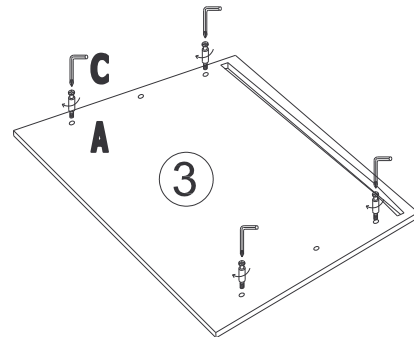

## STEP-2

Put "D" on the □,□,connect□,□ by "A","C",slide □ into groove of panel □,□,the put □ on,screw "A"and tight them.

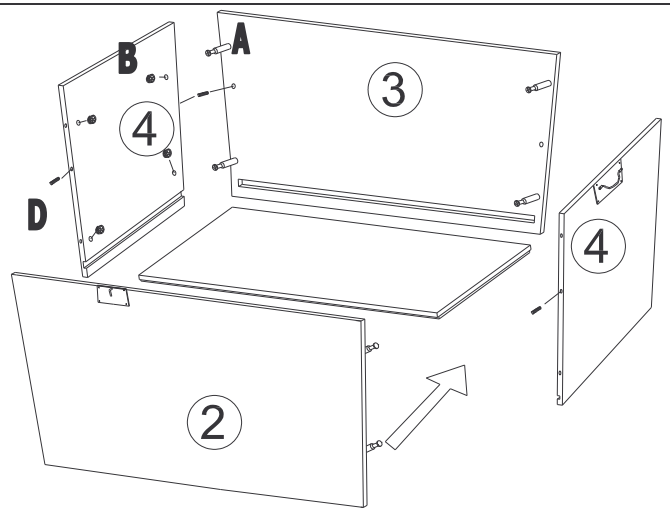

## STEP-3

Turn trunk screws □ on the bottom of trunk by "E".

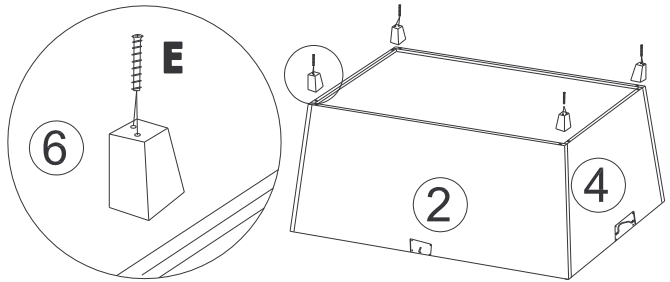

## STEP-4

Connect □ and trunk body with "F".

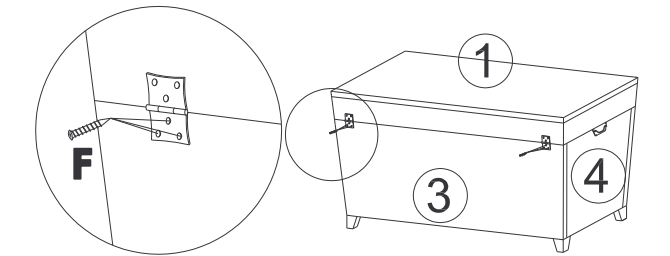

## STEP-5

Open the □,tight screw "F" to attach "G","K" on the □ and trunk.close the □,leave the top open.the top will slowly drop down,finish the assembly.

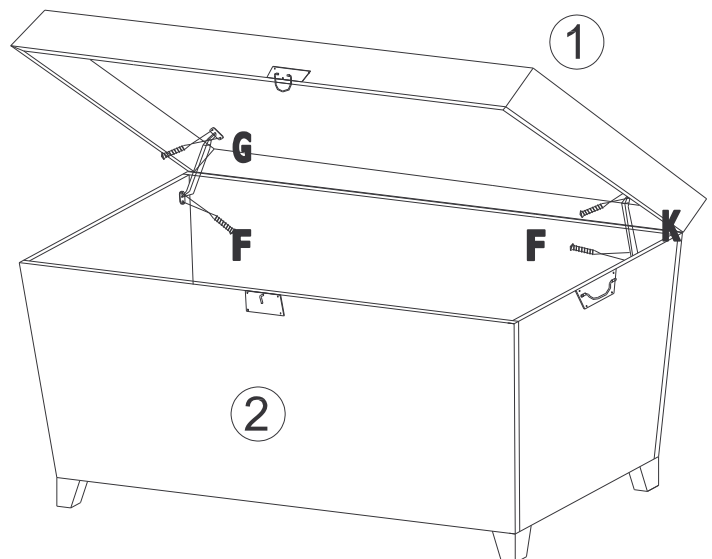

PLEASE COUNT, IDENTIFY AND COMPARE PARTS AND HARDWARE LIST TO BE SURE ALL PARTS ARE PRESENT. IT MAY HELP TO DIVIDE PARTS AND LABEL THEM TO CORRESPOND WITH PART LIST. EXTRA HARDWARE MAY BE INCLUDED. IF ANY ITEMS ARE MISSING, PLEASE CONTACT OUR PARTS/SERVICE DEPARTMENT AT (800)633-5096 OR IN DALLAS (972)869-0111/9AM-4PM MON-FRI CENTRAL TIME. MISSING OR DAMAGED HARDWARE AND/OR PARTS WILL BE REPLACED FREE OF CHARGE. WE DO NOT SELL PARTS. WE DO NOT RECOMMEND MODIFYING PRODUCT(S) AND WE ARE NOT RESPONSIBLE FOR ANY DAMAGES DUE TO PRODUCT MODIFICATION(S). IF THIS PRODUCT HAS NOT BEEN PURCHASED FROM OUR RETAIL AFFILIATES (WITHIN 9 MONTHS), WE ARE UNDER NO OBLIGATION TO PROVIDE PARTS OR REPLACEMENT MERCHANDISE. PARTS WILL NOT BE AVAILABLE FOR ITEMS ARRIVING FULLY ASSEMBLED.

## PARTS REPLACEMENT FORM

STYLE NO.: **CK122400UT**

| CUSTOMER NAME  | PARTS LETTER | PART DESCRIPTION  | QUANTITY NEEDED |
|--|--------------|---|-----------------|
| STREET, CITY, STATE, ZIP   |              |   |                 |
| PHONE#   |              |   |                 |
|  |              | PLEASE INDICATE WHERE YOU PURCHASED THIS ITEM.<br>STORE/WEBSITE/CATALOG |                 |
| SOUTHERN ENTERPRISES INC.<br>P.O. BOX 59996 DALLAS, TEXAS 75229                    |              | / /<br>PLEASE INDICATE COLOR/SIZE/STYLE NUMBER                          |                 |
|  |              | / /   |                 |