



PLAYGROUND

MODEL N° 90200

OWNER'S MANUAL

COPY

Keep this Product ID Number and use when contacting Customer Service:

REGISTER YOUR LIFETIME PRODUCT TODAY!

There are benefits to registering your Lifetime product. With our new online product registration form, it's fast and easy! Register with us at www.lifetime.com and enjoy these great benefits:

- Receive exclusive money-saving offers from BuyLifetime.com, our online store, as well as NEW product notifications and special closeout promotions!
- In the unlikely event of a product recall or safety modification, we will notify you.
- Registering your product guarantees you warranty service. If you do not register your product, your warranty rights will not be diminished. But you will need to provide a sales receipt to verify your product purchase date before warranty service will be provided.

LIFETIME'S PROMISE TO YOU:

Maintaining your privacy is our long-standing policy at Lifetime. And you can rest assured that Lifetime will not sell or provide your personal data to other third parties, or allow them to use your personal data for their own purposes.

We invite you to read our privacy policy at www.lifetime.com

REGISTER today!

Save this owner's manual for future reference and in the event that the manufacturer has to be contacted.

****U.S. and Canada customers ONLY****
IF ASSISTANCE IS NEEDED,

DO NOT CONTACT THE STORE!

CALL OUR CUSTOMER SERVICE DEPARTMENT at 1 (800) 225-3865

HOURS: 7:00 a.m. to 5:00 p.m. Monday through Friday (Mountain Standard Time)

Call or visit our Web site for Saturday hours

Lifetime Products, Inc.

PO Box 160010 • Freeport Center, Bldg. D-11 Clearfield, Utah 84016-0010

For customers outside the U.S. or Canada, please contact the store for assistance.



SAFETY INSTRUCTIONS



FAILURE TO FOLLOW THESE WARNINGS MAY RESULT IN SERIOUS INJURY OR PROPERTY DAMAGE AND WILL VOID WARRANTY.

To ensure safety, do not attempt to assemble this product without reading and following all instructions carefully. Check the entire box and inside all packing materials for parts and/or additional instruction material. Before beginning assembly, identify and inventory all parts and hardware using the parts and hardware lists and identifiers in this document. Proper and complete assembly, use and supervision are essential for proper orientation and to reduce the risk of accident or injury. A high probability of serious injury exists if this product is not installed, maintained, and/or operated properly. Failure to comply with any of the warnings in this instruction manual may result in serious personal injuries such as cuts, broken bones, nerve damage, paralysis, brain injury, or death. Failure to comply may also result in property damage. Please heed all warnings and cautions.

Most injuries are caused by misuse and/or not following instructions. Use caution when using this product.

***This product is intended for use by children ages 3 to 12,
and is for outdoor residential use only.***

BEFORE BEGINNING ASSEMBLY



Keep the hardware bags and their contents separate. If any parts are missing, call our Customer Service Department.



Identify and inventory all parts and hardware using the parts and hardware lists and identifiers in this document.



Test fit all Bolts by inserting them into their respective holes. If necessary, carefully scrape away any excess powder coating buildup from inside the holes. Do not scrape away all of the powder coating. Bare metal may rust. You may need to pound some Bolts into place with a hammer or mallet.

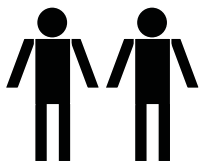

****Two adults required to complete assembly****

Only adults should set up the product. Do not allow children in the setup area until assembly is complete.



TOOLS AND PARTS REQUIRED FOR THIS ASSEMBLY

9/16" Wrench



(2)

5/8" Wrench



(1)

Adjustable Wrench

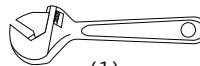

(1)

Screwdriver

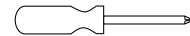

(1)

Scrap Wood



(1)

Ladder



(1)

7/32" Allen Wrench



(included)

ASSEMBLY GUIDES

Refer to the following areas throughout the instructions to assist in the assembly process:

This area is located at the top, left-hand corner of the page and indicates which tools and hardware are needed to complete the assembly steps on a page.



TOOLS AND HARDWARE REQUIRED FOR THIS PAGE

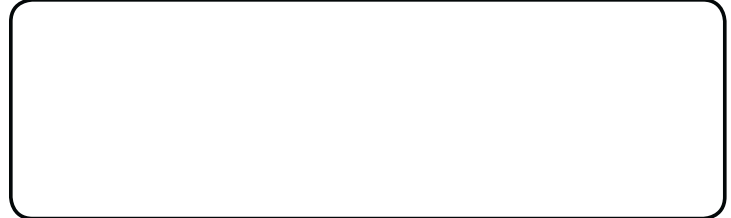

This area is located at the top, right-hand corner of the page and shows an image of the product with shaded parts indicating which section is being assembled.

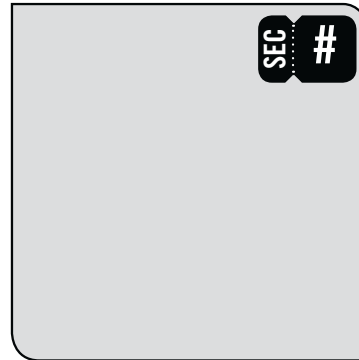

This area is usually located in the bottom, left-hand corner of a step and indicates that special attention is needed to perform a particular part of a step.



Note:

These areas are usually located in the bottom, right-hand corner of a step and indicate that damage to the product or serious injury may occur if the caution or warning is not heeded.



CAUTION



WARNING

****IMPORTANT SAFETY INFORMATION****

PLEASE READ BEFORE BEGINNING ASSEMBLY:

INSTALLATION & GROUND PREPARATION INSTRUCTIONS

- Place the equipment on a level, well-drained ground, not less than 6 ft (1.8 m) from any structure or obstruction such as a fence, garage, or house.
- Provide enough room so that children can use the equipment safely. For example, for structures with multiple play activities, a slide should not exit in front of a swing.
- Separate active and quiet activities from each other. For example, locate sandboxes away from swings or use a guardrail or barrier to separate the sandbox from the movement of the swings.
- Do not install home playground equipment over concrete, asphalt, packed earth, grass, carpet, or any other hard surface. A fall onto a hard surface can result in serious injury to the equipment user (see page 7).
- To prevent serious injury, warn children that they must not use the equipment until properly installed.
- Create a site free of obstacles that could cause injuries – such as low overhanging tree branches, overhead wires, tree stumps and/or roots, large rocks, bricks, and concrete.
- Choose a level location for the equipment. This can reduce the likelihood of the play set tipping over and loose-fill surfacing materials washing away during heavy rains
- For any questions call our Customer Service Department at 1-800-225-3865 for more information.

PLAYGROUND AND SURFACE MATERIALS INSTRUCTIONS

- Use containment, such as digging out around the perimeter and/or lining the perimeter with landscape edging.
- Do not install loose fill surfacing over hard surfaces such as concrete or asphalt.
- Installations of rubber tiles or poured-in-place surfaces (other than loose-fill materials) generally require a professional and are not “do-it yourself” projects.
- Use Playground Surfacing Materials (other than loose-fill material) which comply to the safety standard ASTM F1292 Standard Specification for Impact Attenuation of Surfacing Materials within the Use Zone of Playground Equipment.

OPERATING INSTRUCTIONS

Observing the following instructions and warnings reduces the likelihood of serious or fatal injury:

- The maximum number of occupants that may safely use the entire play set including all components is three with a maximum weight of 405 pounds (184 kg).
- On-site adult supervision should be provided for children of all ages.
- Instruct children not to walk close to, in front of, behind, or between moving items.
- Do not move the equipment while it is in use.

OPERATING INSTRUCTIONS (CONTINUED)

- Instruct children not to twist swing chains or ropes or loop them over the top support bar since this may reduce the strength of the chain or rope.
- Instruct children to avoid swinging empty seats.
- Teach children to sit in the center of the swings with their full weight on the seats.
- Instruct children not to use the equipment in a manner other than intended.
- Instruct children not to get off the equipment while it is in motion.
- To prevent entanglement and strangulation, dress children appropriately using well-fitting shoes and avoiding ponchos, scarves, jackets with neck drawstrings, helmets with straps, and other loose-fitting clothing that is potentially hazardous while using equipment.
- Instruct children not to play when the equipment is wet.
- Instruct children not to attach items to the playground equipment that are not specifically designed for use with the equipment, such as, but not limited to, jump ropes, clothesline, pet leashes, cables and chain as they may cause a strangulation hazard.

MAINTENANCE INSTRUCTIONS

- If routine checks and maintenance procedures are not done, the equipment could overturn and/or become a hazard.
- Check surfacing material and replenish as necessary to maintain proper depth (see page 7).
- Rake surfacing periodically to prevent compaction and maintain appropriate depths.
- Remove any tripping hazards, such as exposed concrete footings, tree stumps, or rocks.
- Check all nuts and bolts twice monthly during the usage season for tightness and tighten as required. It is particularly important that this procedure be followed at the beginning of each season.
- Check all coverings for bolts and sharp edges twice monthly during usage season to be certain they are in place. Replace when necessary. It is especially important to do this at the beginning of each new season.
- Check swing seats, ropes, cables and chains monthly during usage season for evidence of deterioration. Contact customer service for replacement parts.
- Oil all metallic moving parts monthly during the usage period.
- Take plastic swing seats indoors or do not use when the temperature drops below 40°F (5°C).
- Sand rusted areas on tubular members and repaint using a nonlead-based paint meeting the requirements of Title 16 CFR Part 1303.
- If the warning sticker is illegible, destroyed, or removed contact the Customer Service Department at 1-800-225-3865 for a replacement.

Disposal Instructions: Disassemble and dispose of the playground equipment in such a way that no unreasonable hazards will exist at the time the equipment is discarded. Follow all local disposal requirements.

CONSUMER INFORMATION SHEET FOR PLAYGROUND SURFACING MATERIALS*

The U.S. Consumer Product Safety Commission (CPSC) estimates that about 100,000 playground equipment related injuries resulting from falls to the ground surface are treated annually in U.S. hospital emergency rooms. Injuries involving this hazard pattern tend to be among the most serious of all playground injuries, and have the potential to be fatal, particularly when the injury is to the head. The surface under and around playground equipment can be a major factor in determining the injury causing potential of a fall. It is self evident that a fall onto a shock-absorbing surface is less likely to cause a serious injury than a fall onto a hard surface. Playground equipment should never be placed on hard surfaces such as concrete or asphalt and while grass may appear to be acceptable, it may quickly turn to hard packed earth in areas of high traffic. Shredded bark mulch, wood chips, fine sand or fine gravel are considered to be acceptable shock-absorbing surfaces when installed and maintained at a sufficient depth under and around playground equipment.

Table 1 lists the maximum height from which a child would not be expected to sustain a life-threatening head injury in a fall onto different loose-fill surfacing materials if they are

installed and maintained at depths of 6, 9, and 12 inches. However, it should be recognized that all injuries due to falls cannot be prevented no matter what surfacing material is used.

It is recommended that a shock-absorbing material should extend a minimum of 6 ft. in all directions from the perimeter of stationary equipment such as climbers and slides. However, because children may deliberately jump from a moving swing, the shock absorbing material should extend in the front and rear of a swing a minimum distance of 2 times the height of the pivot point measured from a point directly beneath the pivot on the supporting structure.

This information is intended to assist in comparing the relative shock-absorbing properties of various materials. No particular material is recommended over another. However, each material is only effective when properly maintained. Materials should be checked periodically and replenished to maintain correct depth as determined necessary for your equipment. The choice of a material depends on the type and height of the playground equipment, the availability of the material in your area, and its cost.

*****The maximum fall height for this product is 108 in (274 cm).
We recommend using 9 in (23 cm) of Double Shredded Bark Mulch.*****

TABLE 1 — Depth of Surfacing Material Required Based on Fall Heights

Material / Fall Height	5 ft (152 cm)	6 ft (183 cm)	7 ft (213 cm)	9 ft (274 cm)	10 ft (305 cm)	11 ft (335 cm)	12 ft (366 cm)
Double Shredded Bark Mulch	--	6 in (15 cm)	--	--	9 in (23 cm)	12 in (30 cm)	--
Wood Chips	--	6 in (15 cm)	9 in (23 cm)	--	--	--	12 in (30 cm)
Fine Sand	6 in (15 cm)	--	9 in (23 cm)	12 in (30 cm)	--	--	--
Fine Gravel	--	6 in (15 cm)	9 in (23 cm)	--	12 in (30 cm)	--	--
Shredded Tires***	--	--	--	--	6 in (15 cm)	--	--

*This information has been extracted from the CPSC publications "Playground Surfacing--Technical Information Guide" and "Handbook for Public Playground Safety." Copies of these reports can be obtained by sending a postcard to the: Office of Public Affairs, U.S. Consumer Product Safety Commission, Washington, D.C., 20207 or call the toll-free hotline: 1-800-638-2772.

***This data is from tests conducted by independent testing laboratories on a 6-inch depth of uncompressed shredded tire samples produced by four manufacturers. It is recommended that persons seeking to install shredded tires as a protective surface request test data from the supplier showing the critical height of the material when it was tested in accordance with ASTM F1292.

Safety Zone

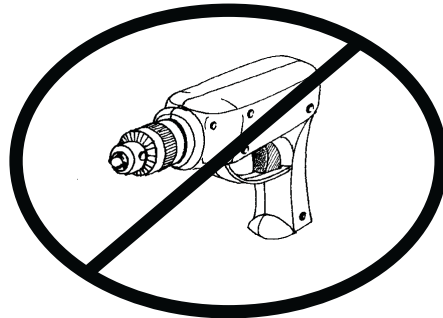
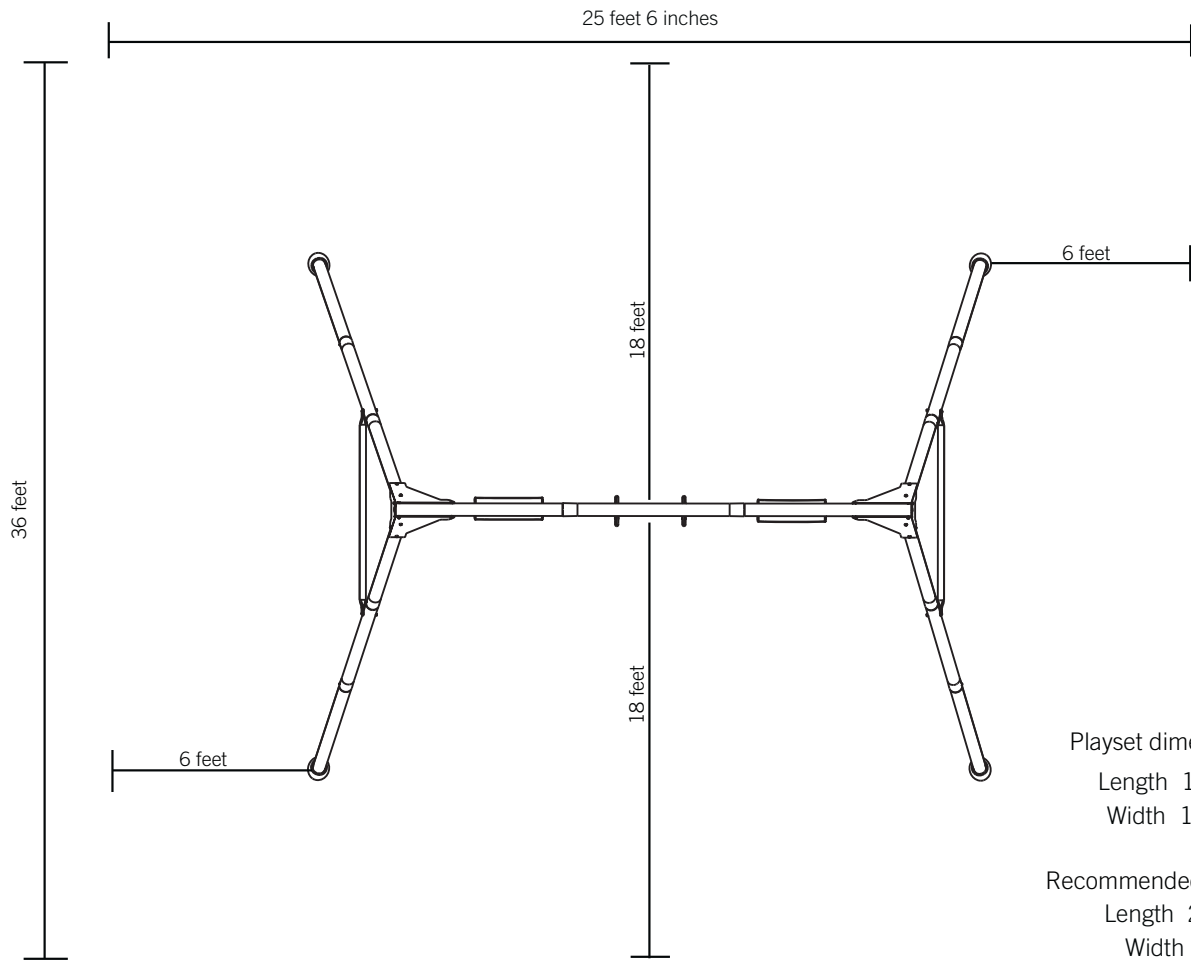

USE AT YOUR OWN RISK!

***USING A DRILL IS NOT RECOMMENDED
FOR DRIVING BOLTS.***

***A cordless drill can be used for driving screws;
however, care should be taken not to over-tighten or strip screws.***

PARTS LIST

<u>ID</u>	<u>Item Description</u>	<u>Qty</u>	<input type="checkbox"/>	<u>ID</u>	<u>Item Description</u>	<u>Qty</u>	<input type="checkbox"/>
				Box 1			
ALE	Bottom Pole	4	<input type="checkbox"/>	BKQ	A-Side Bracket	2	<input type="checkbox"/>
ALH	Top Pole	4	<input type="checkbox"/>	BKP	B-Side Bracket	2	<input type="checkbox"/>
				Box 2			
BKM	Inside Bracket (with notches)	2	<input type="checkbox"/>	BKR	Middle Swing Bar	1	<input type="checkbox"/>
BKN	Turn Bar	2	<input type="checkbox"/>	BKS	Outside Swing Bar	2	<input type="checkbox"/>
BKO	Outside Bracket	2	<input type="checkbox"/>	BKT	Belt Swing	2	<input type="checkbox"/>
ALF	Middle Pole	4	<input type="checkbox"/>	BKU	Trapeze Swing	1	<input type="checkbox"/>
				BFD	Foot Cap	4	<input type="checkbox"/>
				AMT	Warning Sticker	1	<input type="checkbox"/>

HARDWARE LIST

<u>ID</u>	<u>Item Description</u>	<u>Qty</u>	<input type="checkbox"/>	<u>ID</u>	<u>Item Description</u>	<u>Qty</u>	<input type="checkbox"/>
				All Hardware found in Box 2			
BFF Swing Bar Assembly Hardware				BFG A-Frame Assembly Hardware			
BEW	3/8" Square Nut	2	<input type="checkbox"/>	ADS	1/4" x 3/4" Screw	8	<input type="checkbox"/>
BEX	3/8" x 4 1/2" Hex Bolt	2	<input type="checkbox"/>	BFB	3/8" x 3 1/2" Button Head Screw	20	<input type="checkbox"/>
ANK	1/2" Nylon Washer	12	<input type="checkbox"/>	BFC	3/8" Acorn Nut	20	<input type="checkbox"/>
ARP	Pendulum	6	<input type="checkbox"/>	AOQ	7/32" Allen Wrench	1	<input type="checkbox"/>
BEY	Spacer	6	<input type="checkbox"/>	BFH Final Assembly Hardware			
ABB	3/8" Centerlock Nut	4	<input type="checkbox"/>	BFB	3/8" x 3 1/2" Button Head Screw	4	<input type="checkbox"/>
BEZ	3/8" x 2" Hex Bolt	4	<input type="checkbox"/>	BFC	3/8" Acorn Nut	4	<input type="checkbox"/>
ASV	3" Round Cap	2	<input type="checkbox"/>	ARO	Hole Cap	8	<input type="checkbox"/>

PARTS IDENTIFIER

Parts shown at 10% of Actual Size



ALE (x4)
Bottom Pole



ALF (x4)
Middle Pole



ALH (x4)
Top Pole

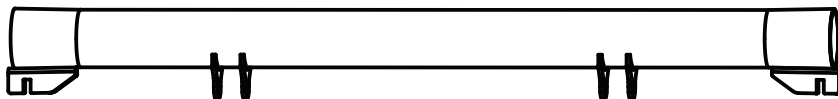

BKR (x1)
Middle Swing Bar

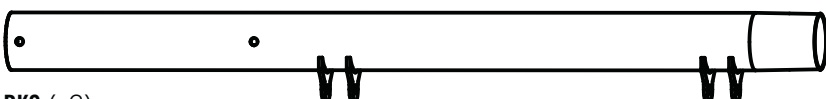

BKS (x2)
Outside Swing Bar

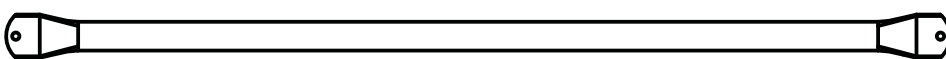

BKN (x2)
Turn Bar

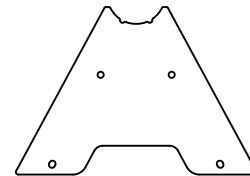

BKM (x2)
Inside Bracket (with notches)

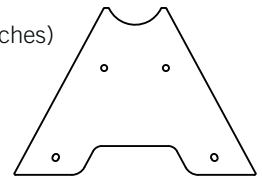

BKO (x2)
Outside Bracket

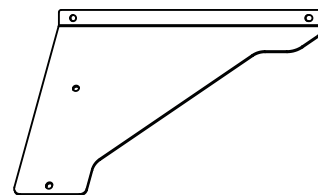

BKQ (x2)
A-Side Bracket

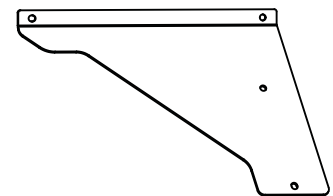

BKP (x2)
B-Side Bracket

PARTS IDENTIFIER

Parts shown at 5% of Actual Size

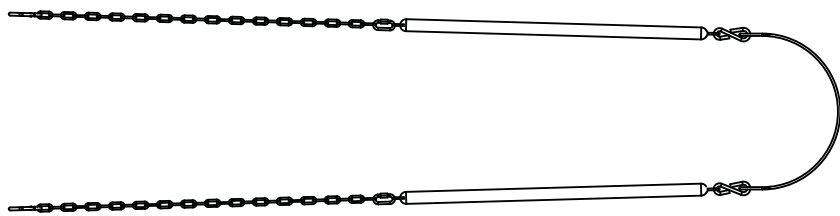

BKT (x2)
Belt Swing

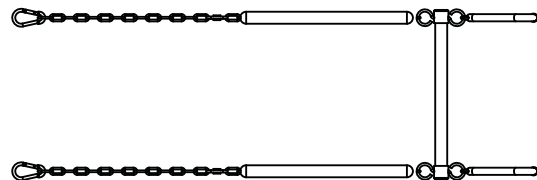

BKU (x1)
Trapeze Swing

Part shown at 25% of Actual Size

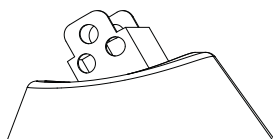

BFD (x4)
Foot Cap

HARDWARE IDENTIFIER

SWING BAR ASSEMBLY HARDWARE

Hardware shown at Actual Size

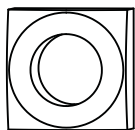

BEW (x2)
3/8" Square Nut

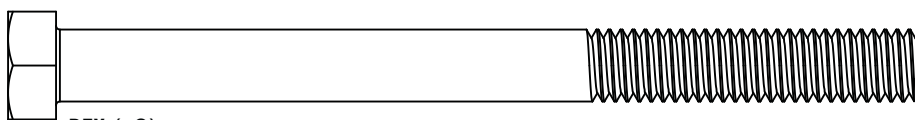

BEX (x2)
3/8" x 4 1/2" Hex Bolt

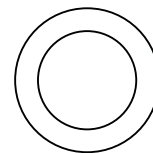

ANK (x12)
1/2" Nylon Washer

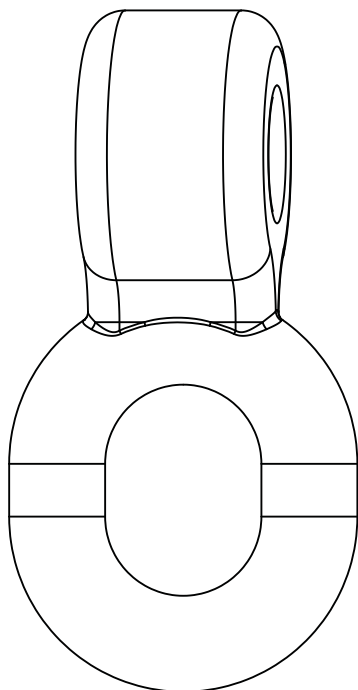

ARP (x6)
Pendulum

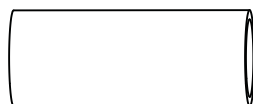

BEY (x6)
Spacer



ABB (x4)
3/8" Centerlock Nut



BEZ (x4)
3/8" x 2" Hex Bolt

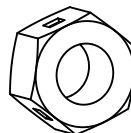
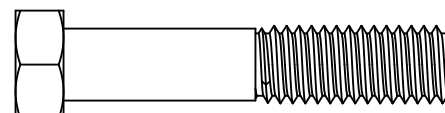
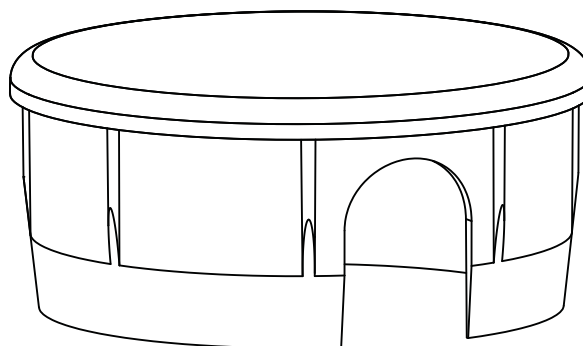

ASV (x2)
3" Round Cap

HARDWARE IDENTIFIER

A-FRAME ASSEMBLY HARDWARE

Hardware shown at Actual Size

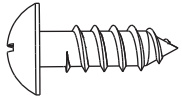

ADS (x8)
1/4" x 3/4" Screw

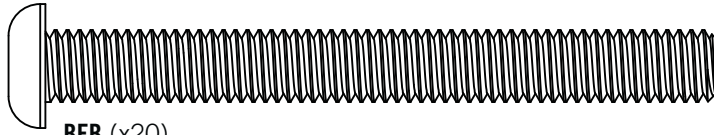

BFB (x20)
3/8" x 3 1/2" Button Head Screw

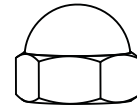

BFC (x20)
3/8" Acorn Nut



AOQ (x1)
7/32" Allen Wrench

FINAL ASSEMBLY HARDWARE

Hardware shown at Actual Size

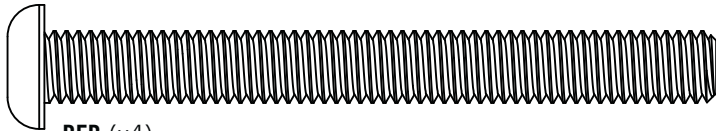

BFB (x4)
3/8" x 3 1/2" Button Head Screw

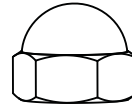

BFC (x4)
3/8" Acorn Nut

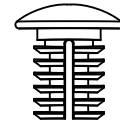

ARO (x8)
Hole Cap

SEC 1 SWING BAR ASSEMBLY

HARDWARE REQUIRED

Hardware shown at Actual Size

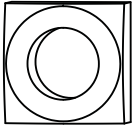

BEW (x2)
3/8" Square Nut

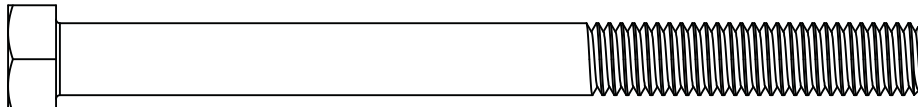

BEX (x2)
3/8" x 4 1/2" Hex Bolt

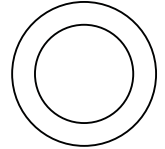

ANK (x12)
1/2" Nylon Washer

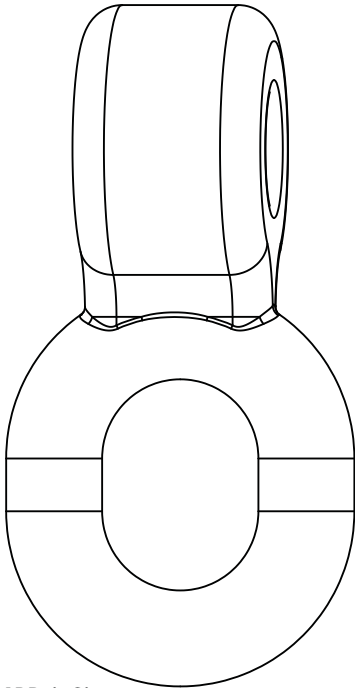

ARP (x6)
Pendulum



BEY (x6)
Spacer



ABB (x4)
3/8" Centerlock Nut



BEZ (x4)
3/8" x 2" Hex Bolt

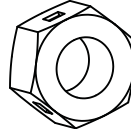
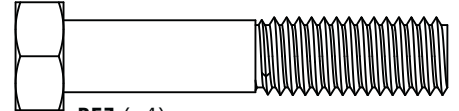
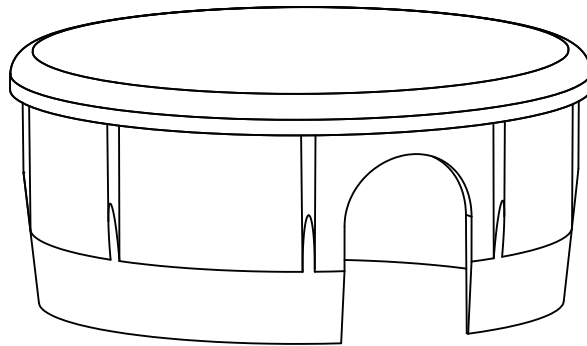

ASV (x2)
3" Round Cap

PARTS REQUIRED

Parts shown at 10% of Actual Size

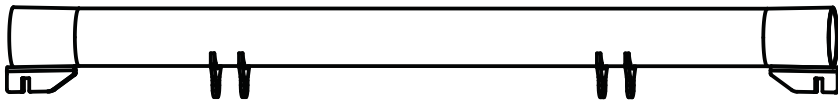

BKR (x1)
Middle Swing Bar

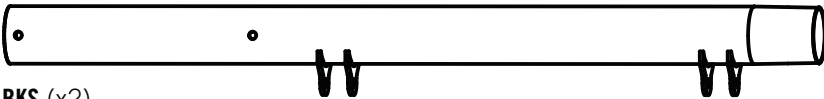

BKS (x2)
Outside Swing Bar

TOOLS REQUIRED

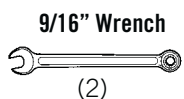

9/16" Wrench

(2)



Adjustable Wrench

(1)



Scrap Wood

(1)



TOOLS AND HARDWARE REQUIRED FOR THIS PAGE

SEC 1

NO TOOLS REQUIRED FOR THIS PAGE

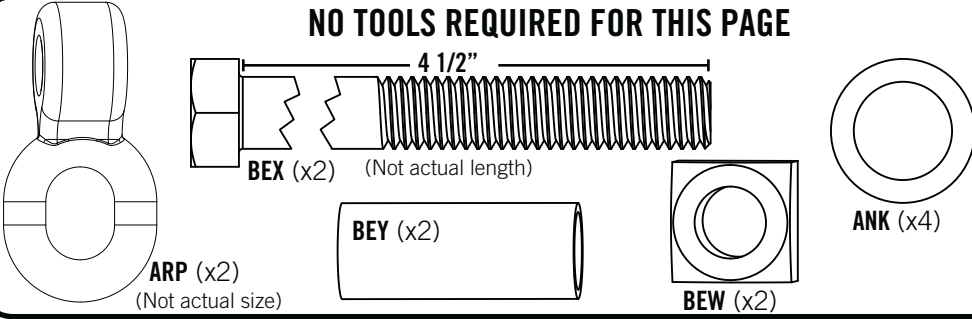

SEC 1.1

Slide an **Outside Swing Bar (BKS)** into the **Middle Swing Bar (BKR)** as shown, and attach the swing bars together with the hardware shown. Position the **1/2" Nylon Washers (ANK)** between the **Pendulum (ARP)** and the brackets.

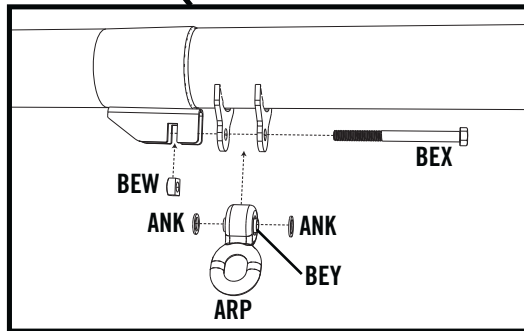
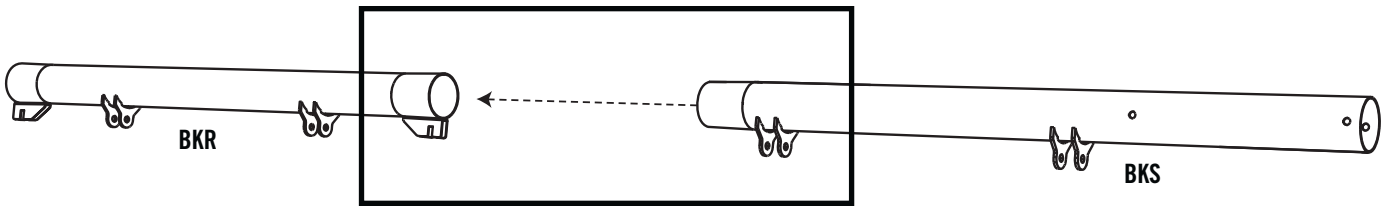

! Note: Only finger tighten the hardware in this step.

SEC 1.2

Slide the other **Outside Swing Bar (BKS)** into the other end of the **Middle Swing Bar (BKR)** as shown, and attach the swing bars together with the hardware shown. Position the **1/2" Nylon Washers (ANK)** between the **Pendulum (ARP)** and the brackets.

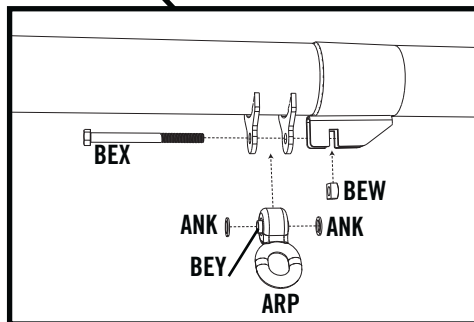
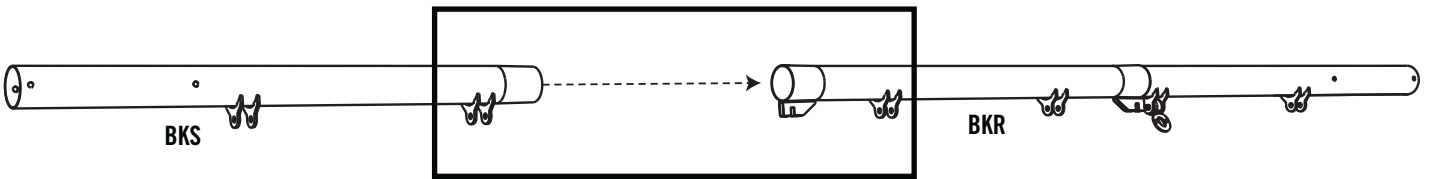

! Note: Only finger tighten the hardware in this step.



TOOLS AND HARDWARE REQUIRED FOR THIS PAGE

SEC 1

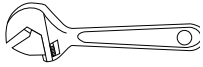

NO NEW HARDWARE REQUIRED FOR THIS PAGE



9/16"

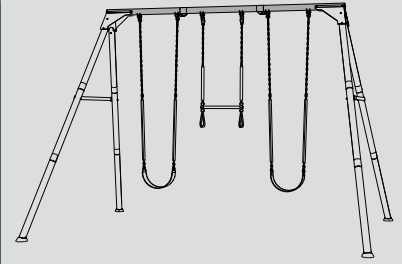

SEC

1.3

ATTENTION: THIS STEP CANNOT BE REVERSED!

In order to seat the swing bar poles, strike each end of the swing bar very hard five to six times on a piece of scrap wood or cardboard. After the swing bar poles have been seated, tighten the hardware from steps 1.1 and 1.2.

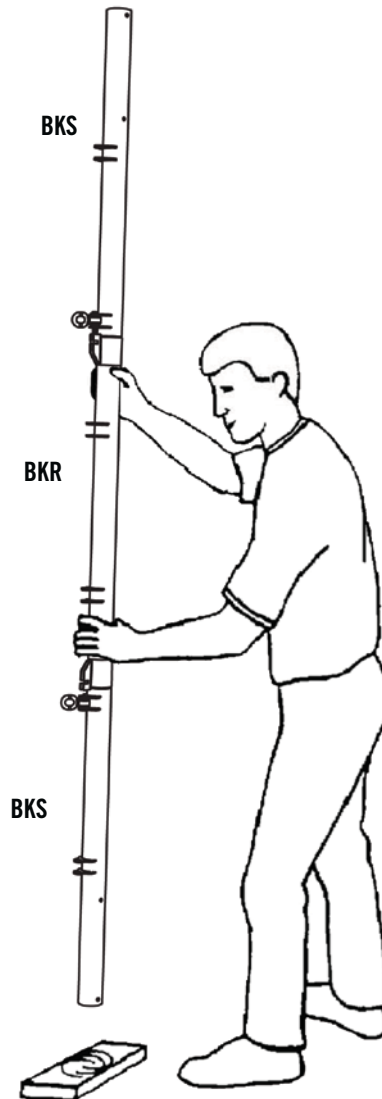

Note: Do not hit your feet with the pole sections, as serious injury could occur.



Note: Tighten the hardware from steps 1.1 and 1.2 before continuing to the next step.



WARNING

The Poles must be seated together! They must be struck on a hard surface five to six times! Failure to seat the Poles correctly could allow the Poles to separate during use, which could lead to serious personal injuries or property damage.



TOOLS AND HARDWARE REQUIRED FOR THIS PAGE

SEC 1

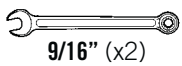

9/16" (x2)

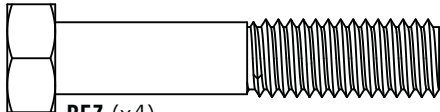

BEZ (x4)

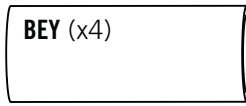

BEY (x4)

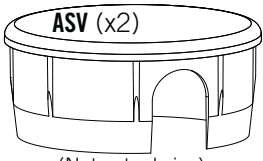

ASV (x2)

(Not actual size)



ABB (x4)



ANK (x8)

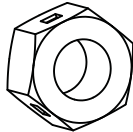
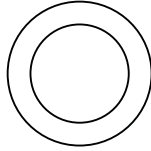
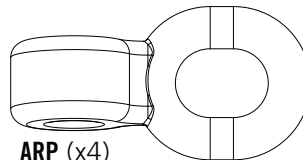

ARP (x4)

(Not actual size)



SEC

1.4

Attach the Swing Hardware to all of the brackets on the Swing Bar Assembly as shown. Position the 1/2" Nylon Washers (ANK) between the Pendulum (ARP) and the brackets.

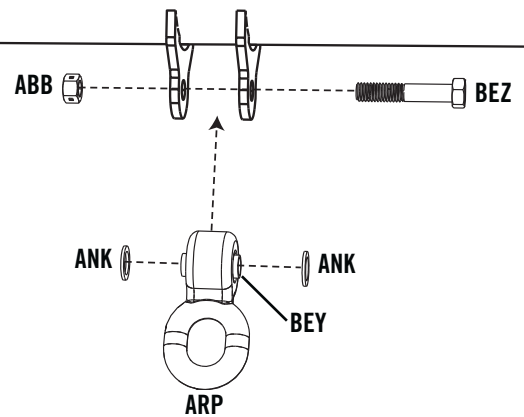
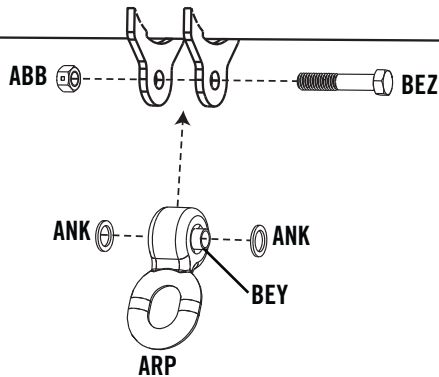

SEC

1.5

Insert the 3" Round Caps (ASV) into the ends of the Swing Bar Assembly as shown.

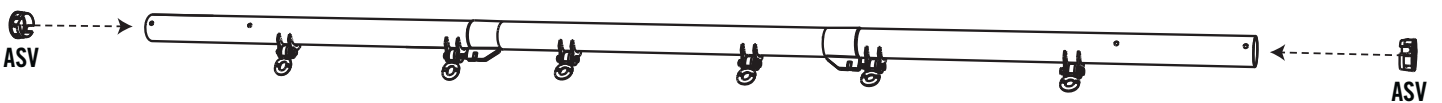

SEC 2 A-FRAME ASSEMBLY

HARDWARE REQUIRED

Hardware shown at Actual Size

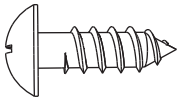

ADS (x8)
1/4" x 3/4" Screw

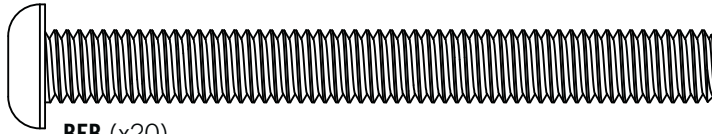

BFB (x20)
3/8" x 3 1/2" Button Head Screw

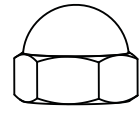

BFC (x20)
3/8" Acorn Nut



A0Q (x1)
7/32" Allen Wrench

PARTS REQUIRED

Parts shown at 10% of Actual Size



ALE (x4)
Bottom Pole

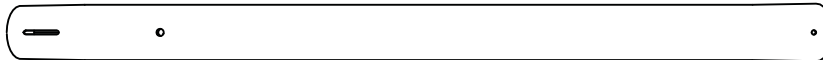

ALF (x4)
Middle Pole



ALH (x4)
Top Pole

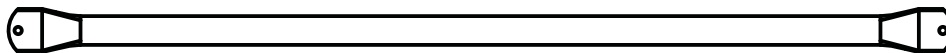

BKN (x2)
Turn Bar

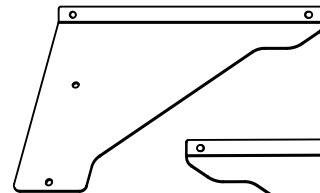

BKQ (x2)
A-Side Bracket

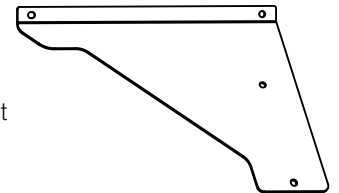

BKP (x2)
B-Side Bracket

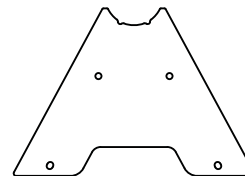

BKM (x2)
Inside Bracket (with notches)

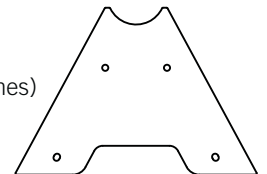

BKO (x2)
Outside Bracket

TOOLS REQUIRED



(1)



(1)



(included)



(1)



TOOLS AND HARDWARE REQUIRED FOR THIS PAGE

SEC 2

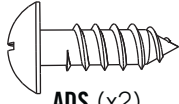
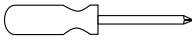

ADS (x2)



SEC

2.1

Align the hole in the **Top Pole (ALH)** with the slot in the **Middle Pole (ALF)** and slide the Middle Pole into the Top Pole as shown. Insert a **1/4" x 3/4" Screw (ADS)** through the small hole in the Top Pole and into the slot in the Middle Pole as shown.

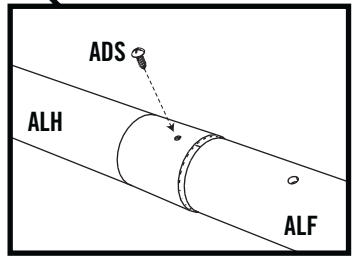
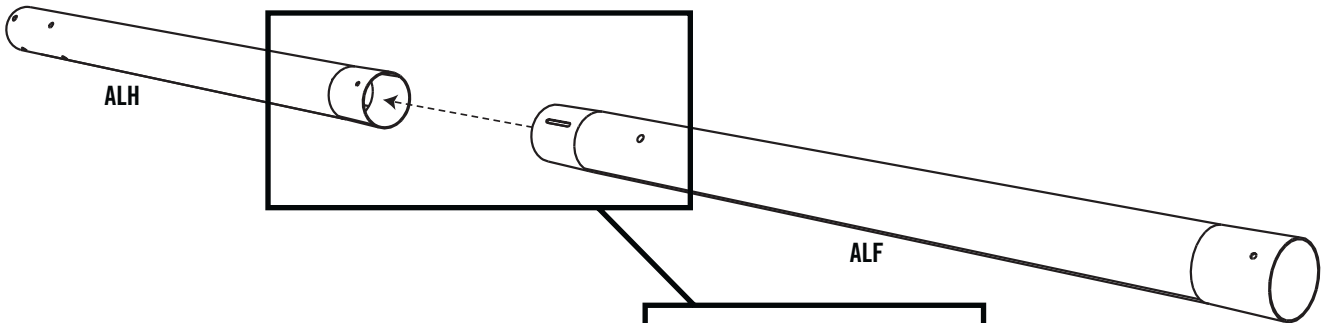

Note: The 1/4" x 3/4" Screw should be flush with the pole, but will spin freely once installed. Do not jam the poles together until instructed.

SEC

2.2

Align the hole in the **Middle Pole (ALF)** with the slot in the **Bottom Pole (ALE)** and slide the Bottom Pole into the Middle Pole as shown. Insert a **1/4" x 3/4" Screw (ADS)** through the small hole in the Middle Pole and into the slot in the Bottom Pole as shown.

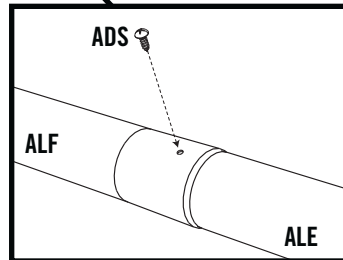
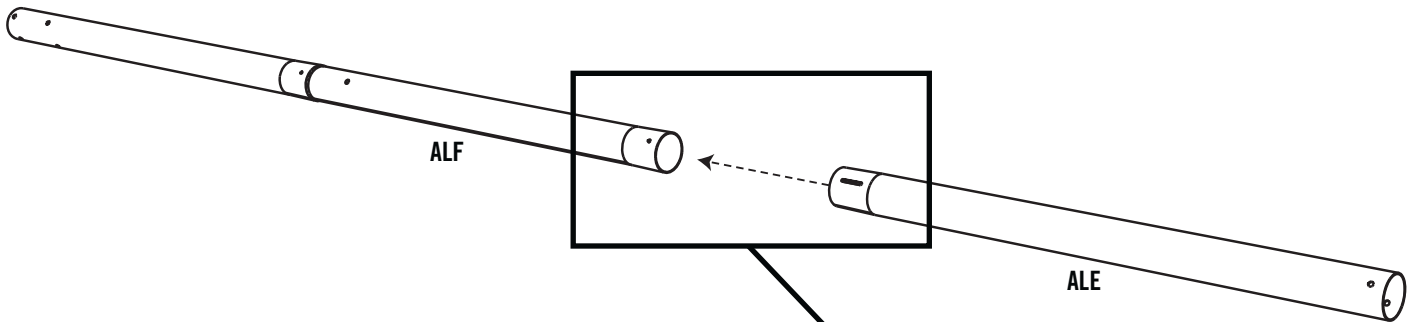

Note: The 1/4" x 3/4" Screw should be flush with the pole, but will spin freely once installed. Do not jam the poles together until instructed.



TOOLS AND HARDWARE REQUIRED FOR THIS PAGE

SEC 2



NO HARDWARE REQUIRED FOR THIS PAGE



SEC

2.3

ATTENTION: THIS STEP CANNOT BE REVERSED!

In order to seat the poles, strike each end of the pole very hard five to six times on a piece of scrap wood or cardboard. This must be done even if the poles cover the slots before seating has occurred.

If the **Top and Middle Poles (ALH & ALF)** do not completely cover the slots on the **Middle and Bottom Poles (ALF & ALE)** after seating, **DO NOT COMPLETE ASSEMBLY**. Call our Customer Service Department.

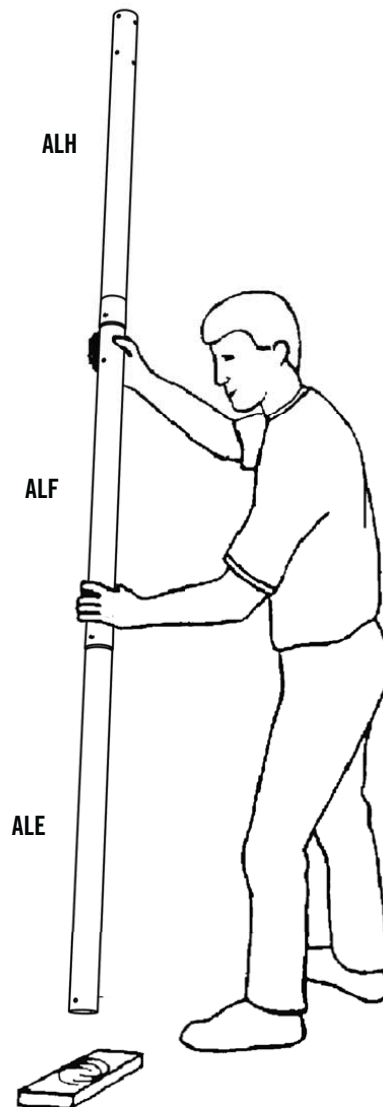

Note: Do not hit your feet with the pole sections, as serious injury could occur.



Note: Repeat steps 2.1 through 2.3 to assemble all four Pole Assemblies before moving to the next step.



WARNING

The Poles must be seated together! They must be struck on a hard surface five to six times! Failure to seat the Poles correctly could allow the Poles to separate during use, which could lead to serious personal injuries or property damage.



TOOLS AND HARDWARE REQUIRED FOR THIS PAGE



7/32"

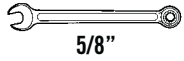

5/8"

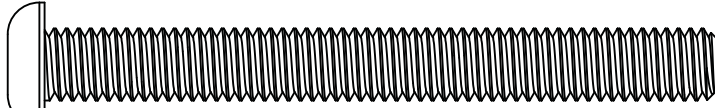

BFB (x4)

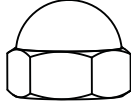

BFC (x4)

SEC 2



SEC

2.4

Lay two Pole Assemblies on the ground with the holes on the poles oriented as shown.

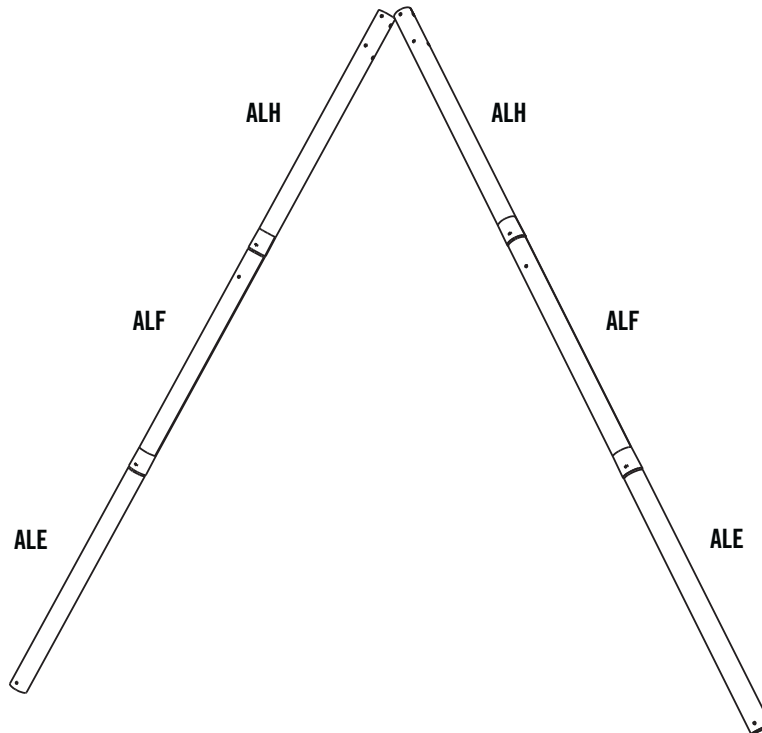

SEC

2.5

Attach an **Outside Bracket (BKO)** and an **Inside Bracket (with notches) (BKM)** to the ends of two **Top Poles (ALH)** with the hardware shown.

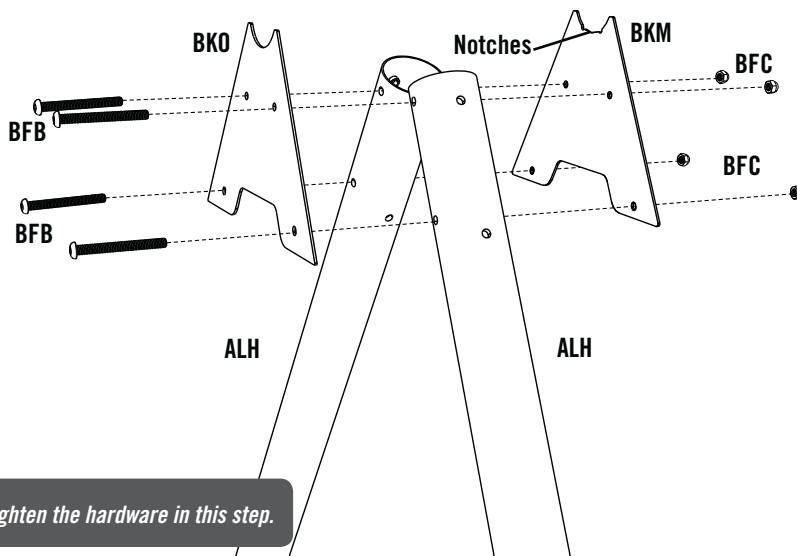

Note: Do not overtighten the hardware in this step.



TOOLS AND HARDWARE REQUIRED FOR THIS PAGE

2.



7/32"



5/8"



BFB (x6)

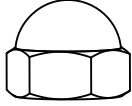

BFC (x6)

SEC 2



SEC

2.6

Attach an **A-Side Bracket (BKQ)** to a **Top Pole (ALH)** by finger tightening the hardware shown. Make sure the straight edge of the A-Side Bracket is against the **Outside Bracket (BKO)** as shown.

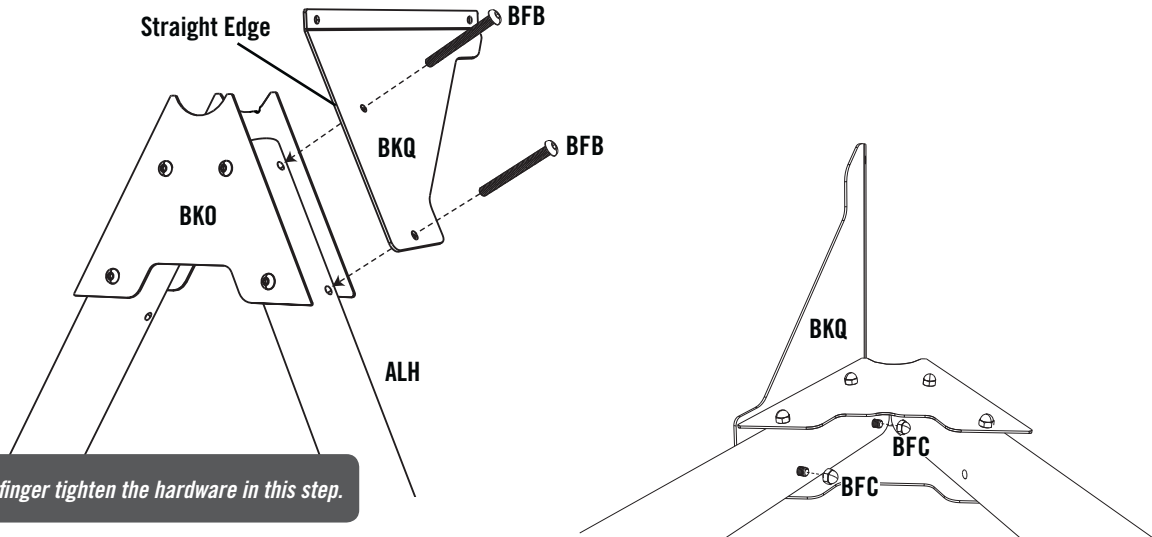

! Note: Only finger tighten the hardware in this step.

! Note: Repeat this step to assemble the B-Side Bracket (BKP) to the other side of the assembly.

SEC

2.7

Attach a **Turn Bar (BKN)** to the assembled A-Frame with the hardware shown.

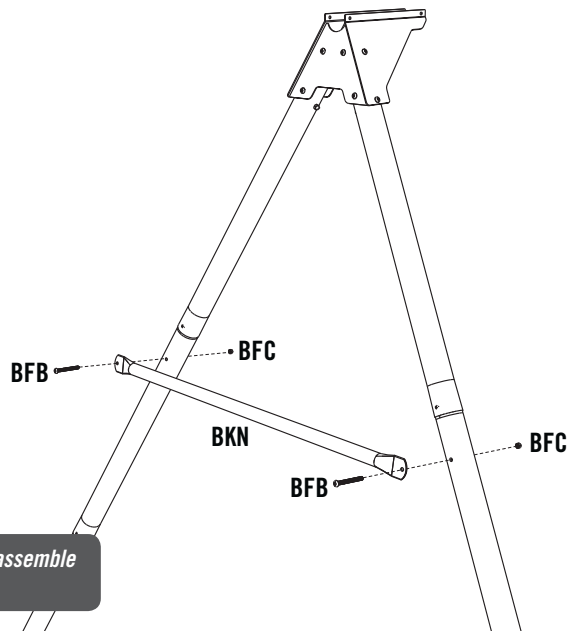

! Note: Repeat steps 2.4 through 2.7 to assemble the other A-Frame.

SEC 3 FINAL ASSEMBLY

HARDWARE REQUIRED

Hardware shown at Actual Size



BFB (x4)
3/8" x 3 1/2" Button Head Screw

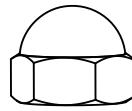

BFC (x4)
3/8" Acorn Nut



ARO (x8)
Hole Cap

PARTS REQUIRED

Parts shown at 5% of Actual Size

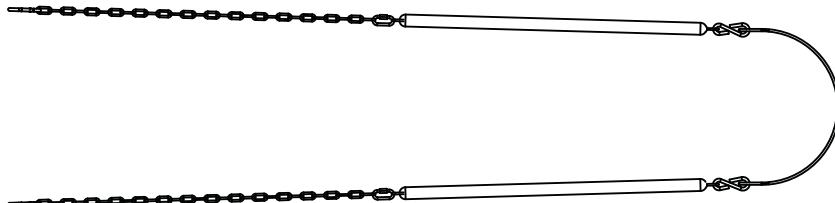

BKT (x2)
Belt Swing

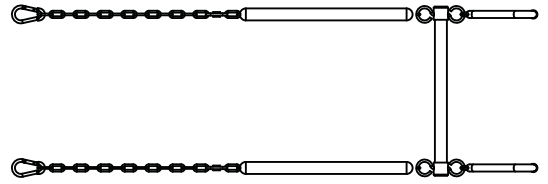

BKU (x1)
Trapeze Swing

Part shown at 25% of Actual Size

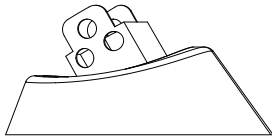

BFD (x4)
Foot Cap

TOOLS REQUIRED

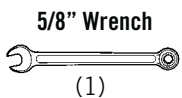

5/8" Wrench
(1)

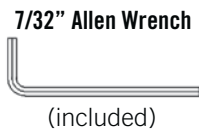

7/32" Allen Wrench
(included)



Ladder
(1)



TOOLS AND HARDWARE REQUIRED FOR THIS PAGE

SEC 3



7/32"

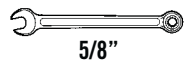

5/8"

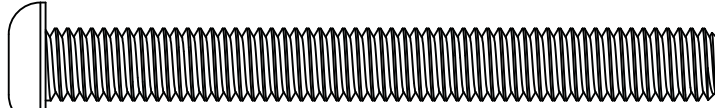

BFB (x4)

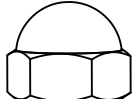

BFC (x4)

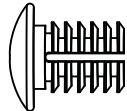

ARO (x8)



3.

SEC

3.1

Attach the Swing Bar Assembly to an A-Frame Assembly as shown with the hardware indicated. For easier assembly, secure the outside hardware first. Return to section two to tighten the hardware in step 2.6.

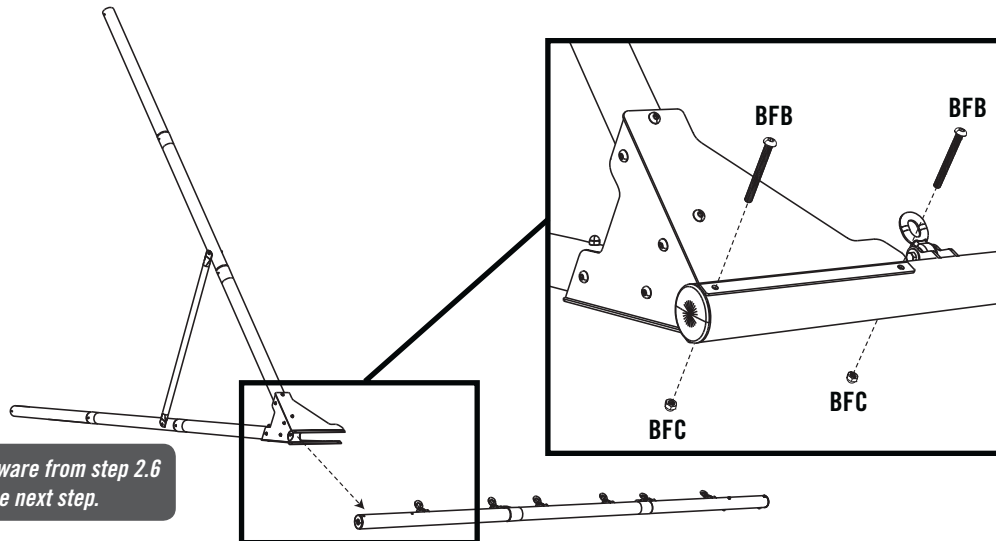

Note: Tighten the hardware from step 2.6 before continuing to the next step.



Note: Repeat this step to assemble the other A-Frame Assembly to the other side of the Swing Bar Assembly.

SEC

3.2

Using two adults, rotate the Swing Set Assembly to its upright position. Then attach the **Foot Caps (BFD)** and **Hole Caps (ARO)** to the ends of the poles as shown.

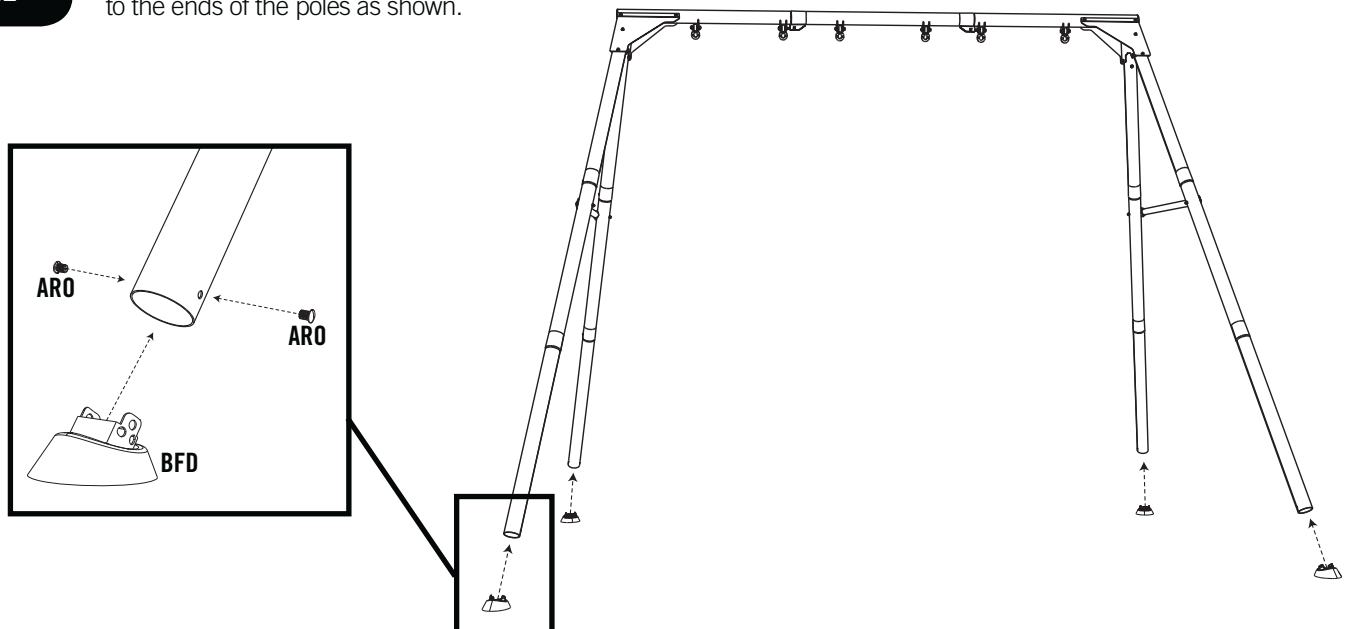



TOOLS AND HARDWARE REQUIRED FOR THIS PAGE

SEC 3



NO HARDWARE REQUIRED FOR THIS PAGE



3.

SEC

3.3

Attach the **Belt Swings (BKT)** and the **Trapeze Swing (BKU)** to the Swing Hardware as shown.

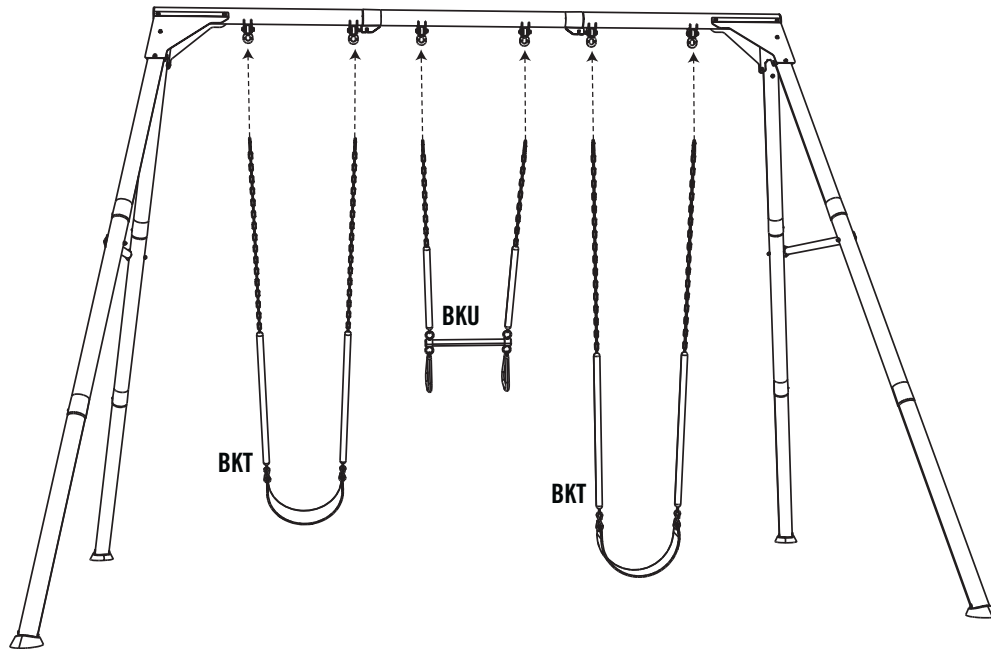

ENHANCE YOUR LIFETIME® PURCHASE BY ADDING ACCESSORIES OR OTHER GREAT PRODUCTS:

To purchase accessories or other Lifetime Products, visit us at:

www.lifetime.com

Or call: 1-800-424-3865

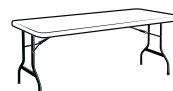
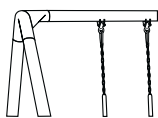

If the warning sticker is illegible, destroyed, or removed, contact Customer Service for a replacement.



WARNING



This product is intended for use by children ages 3 to 12, and is for residential use only. Do not install over concrete, asphalt, packed earth, or any other hard surface. A fall onto a hard surface can result in serious injury.

Observing the following statements and warnings reduces the likelihood of serious or fatal injury:

- On-site adult supervision should be provided for children of all ages.
- Children should not walk close to, in front of, behind, or between moving items.
- Instruct children not to twist swing chains or ropes or loop them over the top support bar since this may reduce the strength of the chain or rope.
- Instruct children to avoid swinging empty seats.
- Teach children to sit in the center of the swings with their full weight on the seats. Never stand, sit or kneel on the swing seat.

- Instruct children not to use the equipment in a manner other than intended.
- Instruct children not to get off equipment while it is in motion.
- To prevent entanglement and strangulation, dress children appropriately using well-fitting shoes and avoiding ponchos, scarves, jackets with neck drawstrings, helmets with straps, and other loose-fitting clothing that is potentially hazardous while using equipment.
- Instruct children not to climb when the equipment is wet.
- Instruct children not to attach items to the playground equipment that are not specifically designed for use with the equipment, such as, but not limited to, jump ropes, clothesline, pet leashes, cables and chain as they may cause a strangulation hazard.
- Make sure guardrails are in place at all times.



ADVERTENCIA



Este producto es para niños de 3 a 12 años de edad. Este producto es para uso residencial únicamente. No lo instale sobre concreto, asfalto, tierra empaquetada o cualquier otra superficie dura. La caída sobre una superficie dura podría ocasionar serias lesiones.

Si se presta atención a los siguientes enunciados y avisos de advertencia se reduce la probabilidad de producirse lesiones serias o mortales:

- Los niños de todas las edades deben estar bajo la supervisión de un adulto en el lugar.
- Los niños no deben caminar junto, en frente, detrás de o entre las piezas móviles.
- Indique a los niños no torcer las cadenas o sogas de los columpios ni pasarlas por encima de la barra de soporte superior, ya que puede reducirse la resistencia de las cadenas o sogas, según sea el caso.
- Indique a los niños que eviten impulsar columpios vacíos.
- Enseñe a los niños a sentarse en el centro de los columpios, con todo su peso en los asientos. Nunca deben pararse ni hincarse en el asiento del columpio.
- Indique a los niños no usar el equipo de ninguna forma diferente a la indicada.
- Indique a los niños no bajarse del equipo cuando esté en movimiento.
- Para evitar la posibilidad de que los niños se enreden y estrangulen, vístalos debidamente con zapatos debidamente ajustados y sin ponchos, bufandas, chamarras con cordones de apriete en el cuello, cascos con correas y otras ropas holgadas que puedan ser peligrosas al usar el equipo.
- Indique a los niños no subirse cuando esté húmedo el equipo.
- Indique a los niños no adherir al equipo de patio de juegos objetos no diseñados específicamente para éste, como cuerdas de saltar, cuerdas de tendedero de ropa, correas de mascotas, cables y cadenas, ya que podrían causar un peligro de estrangulación.
- Asegúrese de que los rieles protectores estén colocados en su lugar todo el tiempo.



AVERTISSEMENT



Ce produit est conçu pour un usage par des enfants âgés de 3 à 12 ans. Ce produit est réservé à un usage personnel seulement. Ne pas installer sur du béton, de l'asphalte, de la terre compactée ou toute autre surface dure. Une chute sur une surface dure peut entraîner des blessures graves.

L'observation des déclarations et des avertissements suivants réduit les risques de blessures graves ou fatales:

- La présence d'un adulte surveillant les enfants de tous âges doit être assurée.
- Veiller à ce que les enfants ne marchent pas près, devant, derrière ou entre les éléments en mouvement.
- Veiller à ce que les enfants ne tordent pas les chaînes ou cordes de la balançoire. De même, veiller à ce que les enfants ne bouclent pas les chaînes ou les cordes au-dessus de la barre de support supérieure, car cela pourrait en réduire leur solidité.
- Veiller à ce que les enfants ne balancent pas les sièges vides.
- Veiller à ce que les enfants s'assoient au centre des sièges de la balançoire, avec leur plein poids sur le siège. Veiller à ne jamais s'asseoir, s'agenouiller ou se tenir debout sur le siège.
- Veiller à ce que les enfants n'utilisent pas l'équipement à d'autres fins que pour l'usage prévu.
- Veiller à ce que les enfants ne descendent pas de l'équipement lorsqu'il est encore en mouvement.
- Pour éviter l'emmêlement des cordes et des chaînes et ainsi éviter tout risque d'étranglement, veiller à habiller les enfants correctement. Utiliser des souliers bien adaptés. Ne pas mettre des ponchos, foulards, blousons avec des cordons près du cou, casques avec des sangles et tout autre vêtement ample pouvant potentiellement s'avérer dangereux lors de l'utilisation de l'équipement.
- Veiller à ce que les enfants ne grimpent pas sur l'équipement quand celui-ci est mouillé.
- Veiller à ne pas attacher d'objets sur l'équipement de jeu non spécifiquement conçus pour cet équipement, tels que, mais sans s'y limiter, cordes à sauter, cordes à linge, laisses d'animaux, câbles et chaînes. Ceux-ci posent un risque d'étranglement.
- S'assurer que des garde-fous sont en place en tout temps.

Lifetime Products, Inc
Clearfield, UT 84016

www.lifetime.com

1/05/2009

1049933

WARRANTY INFORMATION

LIFETIME PLAYGROUND EQUIPMENT

1-YEAR LIMITED FACTORY WARRANTY*

THE MANUFACTURER RESERVES THE RIGHT TO MAKE SUBSTITUTIONS TO WARRANTY CLAIMS IF PARTS ARE UNAVAILABLE OR OBSOLETE.

1. Lifetime Playground systems are warranted to the original purchaser to be free from defects in material or workmanship for a period of one year from the date of original retail purchase. The word “defects” is defined as imperfections that impair the use of the product. Defects resulting from misuse, abuse or negligence will void this warranty. This warranty does not cover defects due to improper installation, alteration or accident. This warranty does not cover damage caused by vandalism, rusting, “acts of nature” or any other event beyond the control of the manufacturer.
2. This warranty is nontransferable and is expressly limited to the repair or replacement of defective playground equipment. If the equipment is defective within the terms of this warranty, Lifetime Products, Inc. will repair or replace defective parts at no cost to the purchaser. Shipping charges to and from the factory are not covered and are the responsibility of the purchaser. Labor charges and related expenses for removal, installation or replacement of the playground system or its components are not covered under this warranty.
3. This warranty does not cover scratching or scuffing of the product that may result from normal usage. In addition, defects resulting from intentional damage, negligence, unreasonable use or hanging from the net or rim will void this warranty.
4. Liability for incidental or consequential damages is excluded to the extent permitted by law. While every attempt is made to embody the highest degree of safety in all equipment, freedom from injury cannot be guaranteed. The user assumes all risk of injury resulting from the use of this product. All merchandise is sold on this condition, and no representative of the company may waive or change this policy.
5. This product is not intended for institutional or commercial use; Lifetime Products, Inc. does not assume any liability for such use. Institutional or commercial use will void the warranty.
6. This warranty is expressly in lieu of all other warranties, expressed or implied, including warranties of merchantability or fitness for use to the extent permitted by Federal and state law. Neither Lifetime Products, Inc., nor any representative assumes any other liability in connection with this product. This warranty gives you specific legal rights, and you may also have other rights which vary from state to state.

ALL WARRANTY CLAIMS MUST BE ACCOMPANIED BY A SALES RECEIPT.

REPORT PRODUCT DEFECTS IN WRITING TO:

Lifetime Products, Inc., PO Box 160010 Clearfield, UT 84016-0010 or call (800) 225-3865 M-F 7 a.m. to 5 p.m. MST.

Please include your dated sales receipt and photographs of damaged parts.

Save this owner’s manual for future reference and in the event that the manufacturer has to be contacted.

To register the product, visit our Web site at www.lifetime.com



www.lifetime.com

*Warranty is only valid in the United States.