

Family: Plantation | Item No. 4889 BB/PZ

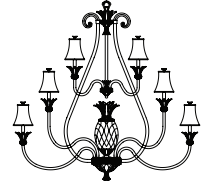

**Drawing 1 - Fixture Assembly**

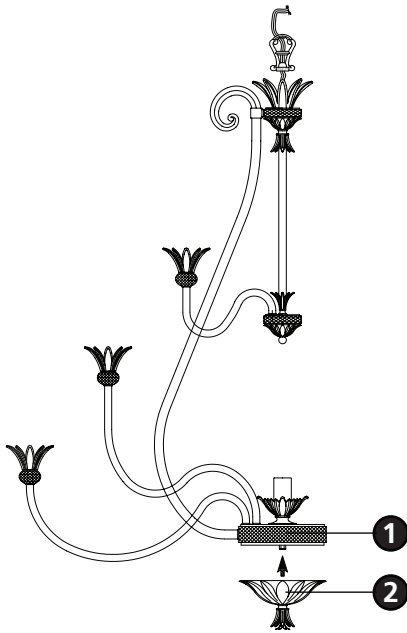

**Drawing 2 - Glass Installation**

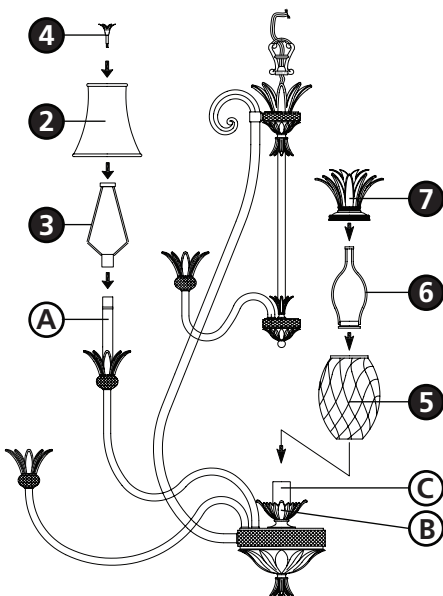

▼ start here

**1**

1. Find a clear area in which you can work.
2. Unpack fixture and glass from carton.
3. Carefully review instructions prior to assembly.

**\*\*\* The construction of this fixture will be accomplished by first assembling the main body of the fixture, making all necessary electrical connections, hanging the fixture from the ceiling, and then installing the fixture glass.**

**SAFETY WARNING: READ WIRING AND GROUNDING INSTRUCTIONS (I.S. 18) AND ANY ADDITIONAL DIRECTIONS. TURN POWER SUPPLY OFF DURING INSTALLATION. IF NEW WIRING IS REQUIRED, CONSULT A QUALIFIED ELECTRICIAN OR LOCAL AUTHORITIES FOR CODE REQUIREMENTS.**

**2**

1. Spread top tier of arms until they are 120 degrees apart. Spread second tier of arms 60 degrees apart. Spread bottom tier of arms 30 degrees apart.
2. Thread bottom finial (2) onto bottom of main body assembly (1) - see **Drawing 1**.
3. Please refer to the hanging instruction sheet (**I.S. 19-50**) provided to continue installation of this fixture. Then refer back to this sheet to continue install glass.

**3**

1. To install glass, slip shade harp (3) onto the candle sleeve (A) - see **Drawing 2**.
2. Attach shade (2) by placing over shade harp (3) and threading shade finial (4) into threaded hole on top of shade harp (3).
3. Repeat steps 1 and 2 for remaining arms.
4. Slip center glass (5) into the center glass fitter (B).
5. Take center harp (6) and thread into socket (C) to hold glass in place.
6. Thread crown (7) onto top of harp (6).

5.30.08

Hanging instructions for 3 tier fixture under 50 lbs.

**Drawing 1 - Fixture Assembly**

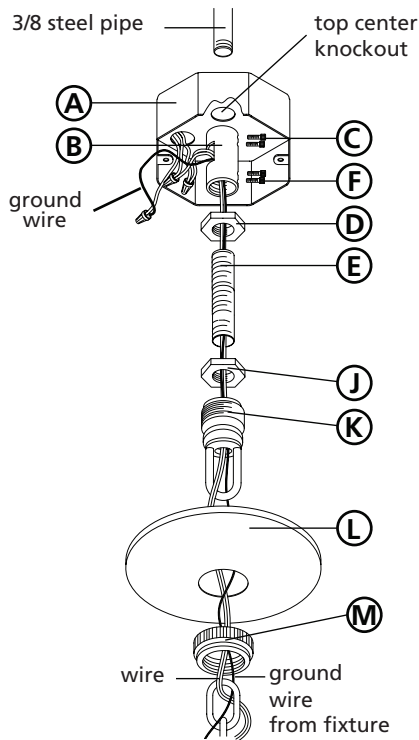

## ▼ start here

**1**

1. Shut off electrical current before starting. If the fixture you are replacing is turned on and off by a wall switch, simply turn the switch off. If not, remove the appropriate fuse (or open the circuit breakers) until the fixture is dead.

• **DO NOT RESTORE CURRENT - EITHER BY FUSE, BREAKER, OR SWITCH - UNTIL THE NEW FIXTURE IS COMPLETELY WIRED AND IN PLACE.**

2. Supply wires shall enter the outlet box (A) through any knockout EXCEPT the top center knockout - see **Drawing 1**.

**2**

1. Fixture is to be mounted by a 3/8 steel pipe with 3/8 -18 NPSM thread, 3/4" threads at both ends (not supplied). Pipe should be anchored to structure or bridging member with sufficient strength to support 4 times the fixtures weight - see **Drawing 2**.

2. Adjust pipe so 1/2" of 3/8 steel pipe extends into the junction box, at the center knockout.

**3**

1. Thread pipe coupler (B) onto protruding pipe inside outlet box. Secure in place by tightening allen head screw (C) - see **Drawing 1**.

2. Thread hexnut (D) onto threaded nipple (E). Thread nipple (E) into coupler (B). Secure in place by tightening hexnut (D) against coupler (B) and then tightening allen screw (F).

3. Thread hexnut (J) onto nipple (E). DO NOT tighten hexnuts (J) at this time.

4. Thread screw collar loop (K). Adjust loop height so the half of the exterior thread on screw collar loop (K) is exposed when canopy (L) is held up to the ceiling.

**4**

1. Determine length of chain you will require. Attach one end of length of chain to fixture.

2. Slip threaded ring (M) and canopy (L) onto chain - see **Drawing 1**.

3. Attach fixture with chain to screw collar loop (K). Please get assistance, weight and size of fixture is difficult to manage alone.

4. Weave ground wire, and supply wire, through chain, up through center of screw collar loop (K), through center of nipple (E), and out the opening on the side of coupler (B).

5. Make electrical connections from supply wire to fixture lead wires. Refer to instruction sheet (I.S. 18) and follow all instructions to make all necessary wiring connections

6. After connections are made slip wires into junction box. Slip canopy along chain and up to ceiling. Thread thread ring (M) onto loop and tighten to secure canopy to ceiling.

**Drawing 2 - Installation Example**

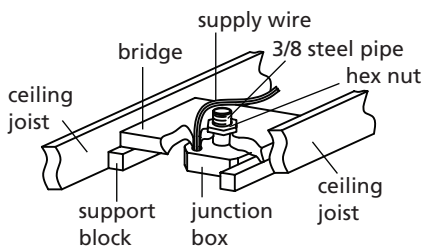

## Drawing 1 - Flush Mount



## Drawing 2 - Chain Hung

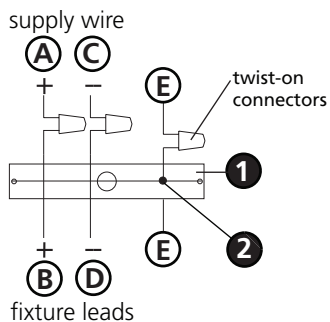

## Drawing 3 - Post-Mount

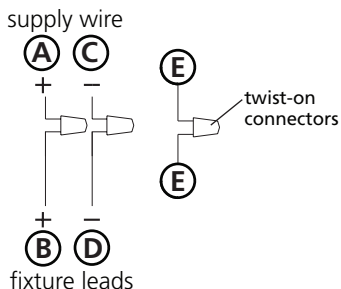

**SAFETY WARNING: READ WIRING AND GROUNDING INSTRUCTIONS (I.S. 18) AND ANY ADDITIONAL DIRECTIONS. TURN POWER SUPPLY OFF DURING INSTALLATION. IF NEW WIRING IS REQUIRED, CONSULT A QUALIFIED ELECTRICIAN OR LOCAL AUTHORITIES FOR CODE REQUIREMENTS.**

## wiring instructions

### Indoor Fixtures

1. Connect positive supply wire **(A)** (typically black or the smooth, unmarked side of the two-conductor cord) to positive fixture lead **(B)** with appropriately sized twist on connector - see **Drawings 1 or 2**.
2. Connect negative supply wire **(C)** (typically white or the ribbed, marked side of the two-conductor cord) to negative fixture lead **(D)**.
3. Please refer to the **grounding instructions** below to complete all electrical connections.

### Outdoor Fixtures

1. Connect positive supply wire **(A)** (typically black or the smooth unmarked side of the two-conductor cord) to positive fixture lead **(B)** with appropriately sized twist on connector - see **Drawings 2 or 3**.
2. Connect negative supply wire **(C)** (typically white or the ribbed, marked side of the two-conductor cord) to negative fixture lead **(D)**.
3. Cover open end of connectors with silicone sealant to form a watertight seal.
  - If installing a wall mount fixture, use caulk to seal gaps between the fixture mounting plate (backplate) and the wall. This will help prevent water from entering the outlet box. If the wall surface is lap siding, use caulk and a fixture mounting platform specially.
4. Please refer to the **grounding instructions** below to complete all electrical connections.

## grounding instructions

### Flush Mount Fixtures

For positive grounding in a 3-wire electrical system, fasten the fixture ground wire **(E)** (typically copper or green plastic coated) to the fixture mounting strap **(1)** with the ground screw **(2)** - see **Drawing 1**.

Note: On straps for screw supported fixtures, first install the two mounting screws in strap. Any remaining tapped hole may be used for the ground screw.

### Chain Hung Fixtures

Loop fixture ground wire **(E)** (typically copper or green plastic coated) under the head of the ground screw **(2)** on fixture mounting strap **(1)** and connect to the loose end of the fixture ground wire directly to the ground wire of the building system with appropriately sized twist-on connectors - see **Drawing 2**.

### Post-Mount Fixtures

Connect fixture ground wire **(E)** (typically copper or green plastic coated) to power supply ground with appropriately sized twist-on connector inside post. Cover open end of connector with silicone sealant to form a watertight seal - see **Drawing 3**.