



WRIGHT TOOL

PERFECTING PERFORMANCE™

CATALOG 82



perfecting **Performance™**...

There have been a lot of positive additions made here at Wright Tool. In the past year, we've worked on new ways to support our distributors and end-users from providing more information on our web site such as Request a Quote, our updated Safety Program to online training programs on Wright Tool University. We have looked at ways that we can make things better for our end-users and distributors – all in the spirit of our new company tagline, “Perfecting Performance.”

While the tagline may be new, the spirit is not. For over 80 years we have been a company that has constantly put our customer on the forefront of our minds and our innovations. We continually ask ourselves how we can make our products better, the experience better and our processes better for you, our customers. Perfecting Performance is ingrained in everything we do because it is not only our tagline, it is our company mantra.

Although we are made in the U.S.A., our reach is global. We're supporting the global infrastructure with reach in areas such as Dubai, Spain and Russia. We make heavy-duty hand tools you have come to depend on in industries such as Refinery, Power Generation, Distribution & Transmission, Mining and Wind Turbines. All around the world end-users know if they need a heavy-duty hand tool they can rely on and keep them safe, they need a Wright tool.

You'll see in this catalog how we are Perfecting Performance in our product offerings. We are introducing new, innovative tools to our already vast line of heavy-duty hand tools that will make your life easier as well as expanded existing lines and specials. This is just one example of how we constantly strive to make our products better for you.

At the end of the day, it is our customers who inspire us to consistently work harder and perfect the performance in everything we do. We have been doing this for over 80 years, and because of you, will continue to do so well into the future. We thank you again for your continued support of Wright Tool and we will continue to provide you the best tools on the market that you need to be successful on the job.

*Sincerely,
Terry G. Taylor,
President and CEO*

Owners Of Wright Tool



Terry Taylor



Patricia Taylor



Tom Futey

How to Buy.

Wright Tool is proud to partner with thousands of distributors world wide to bring our products to tool users where they need them, and when they need them. To locate a distributor near you, simply go to www.wrighttool.com and click on "How to Buy" to use our "Distributor Locator." If you cannot find a distributor in your location, please email wrighttool@ultlead.com, or call (800)321-2902 and we will assist you with your purchase.

Visit us at
www.wrighttool.com



Wright Tool is proud to announce its new online training tool, "Wright Tool University." Wright Tool University will give you key information on our manufacturing process, the materials we use in our state-of-the-art tools, and the standards to which our tools conform, and in many cases, exceed. In addition to product information, you can also learn about what makes us stand apart as a company in the industries in which we specialize.

Hand Tool Safety Program.

Please visit us online at www.wrighttool.com to request a FREE hand tool safety DVD, a \$190 Value. Safety is of the highest priority at Wright Tool and we want our customers to have the knowledge to use our products safely. Key features of our program include tips for using our hand tools, and safety certificates.



INDUSTRIES SERVED

INDUSTRIES SERVED



Refinery



Mining



Oil Field/Derrick



Steel Mill



Power Generation



Bridge Building



Power Delivery/Lines



Sky Cranes



Chemical Plant



Dam/River



Wind Turbine



Road Building/Excavation



Structural/Iron Construction



**Concrete Facility/Quarry/
Plant/Crusher**

OIL

Exploration and exploitation, drilling and refining, foreign and domestic, at the end of the day, it doesn't matter what part of the oil industry you work under.

We at Wright Tool understand you have a challenge for which you need safe, reliable hand tools. While the industry itself is facing many new obstacles, Wright Tool is the one constant on which the industry can rely. Our large combination wrenches with openings up to 4" SAE, and 80mm metric, provide the oil industry with the best tools for its heavy-duty applications.

POWER

Power is what runs our country and our communities. Nothing is more important than keeping our infrastructure working properly, and often times this means repairing and maintaining power sources in dangerous situations. We at Wright Tool have worked with companies on the forefront of the power industry in generation, transmission, and distribution for decades, and will continue to support this industry well into the future. We support this special industry by providing special tools and custom sets for nuclear and wind power companies. You will find our WrightGrip™ wrenches and double pawl ratchets in the hands of power technicians across the globe, because they trust the Wright Tool quality and safety while performing their jobs.

MINING

From underground to surface mining, bulk materials handling to exploration and new mine development, we know some of the toughest users of hand tools work in the mining industry, and no other tool company offers safer, more reliable tools than Wright. We offer impact sockets up to 3-1/2" drive, striking wrenches up to 4-5/8" and 80MM, and torque multipliers that reach 12,000 ft. lbs. We know your job defines heavy duty, and we provide the tools that allow you to do the job safely, and accurately.

Mission Statement:

Our mission is perfecting performance, the mantra we follow every day, guiding our decisions and actions. Operational excellence and continual improvement allow us to maintain our industry leadership status and service excellence as we provide the ultimate in customer satisfaction. Perfecting Performance is our commitment to Wright Tool products, proprietary processes and our quality process.

Quality Process

PERFECTING PERFORMANCE™

Perfecting Performance Quality Process is a system for identifying customer needs and flawlessly translating them into quality products and services which exceed the customer's expectations.

Perfecting.....**P**roperties requisite to its nature, without flaw or fault
Performance.....**P**ossessing and successfully using knowledge
Quality**Q**uintessential attribute
Process.....**P**rogressive act of forward movement

Tools we use to guide the process:

- Process Mapping
- 5 Why's
- Pareto Chart
- Cost/Benefit
- Interpersonal skills
- Factors
- Cause & Effect
- Measurement
- Standardization
- Gap Analysis
- Variance
- Observation
- Knowledge base
- Predictability
- Discipline
- Data
- Statistical Analysis

ASME Standards Conformance

All products manufactured by Wright Tool are designed to conform to the applicable ASME Standards for the particular tool. [Special Note: Wright Tool reserves the right to exceed ASME Standards on selected items.]

Notice: We reserve the right to make product additions and improvements. This may involve dimensional changes. Visit our web site, www.wrighttool.com, for the latest information, and also for additional information and for tips on safety and tool usage.

Wright Tool Lifetime Warranty

Since 1927, the Wright Tool Company has manufactured top quality hand tools. The use of WrightAlloy™ steel, precision heat treating, and advanced manufacturing techniques results in products of long life, durability and toughness. Therefore, for as long as you own it, any product manufactured by Wright Tool which fails to render service due to defect in workmanship or materials will be replaced at no charge. This warranty does not apply to any defects or problems caused in whole or part by misuse, abuse, alteration, or worn out from use. Wright Tool makes no other warranties, express or implied, with respect to the tools or their suitability for specific applications. Replacement is the exclusive remedy, and Wright Tool neither assumes, nor authorizes any person to assume for it, any other warranty, or obligation express or implied.

Wright products are designed and manufactured to meet or exceed the following ASME hand tool standards:

- ASME B107.100 – Flat Wrenches
- ASME B107.110 – Socket Wrenches
- ASME B107.59 – Striking Wrenches
- ASME B107.300 – Torque Instruments
- ASME B107.400 – Striking Tools
- ASME B107.410 – Struck Tools
- ASME B107.500 – Pliers
- ASME B107.510 – Pliers and Shears
- ASME B107.600 – Screwdrivers

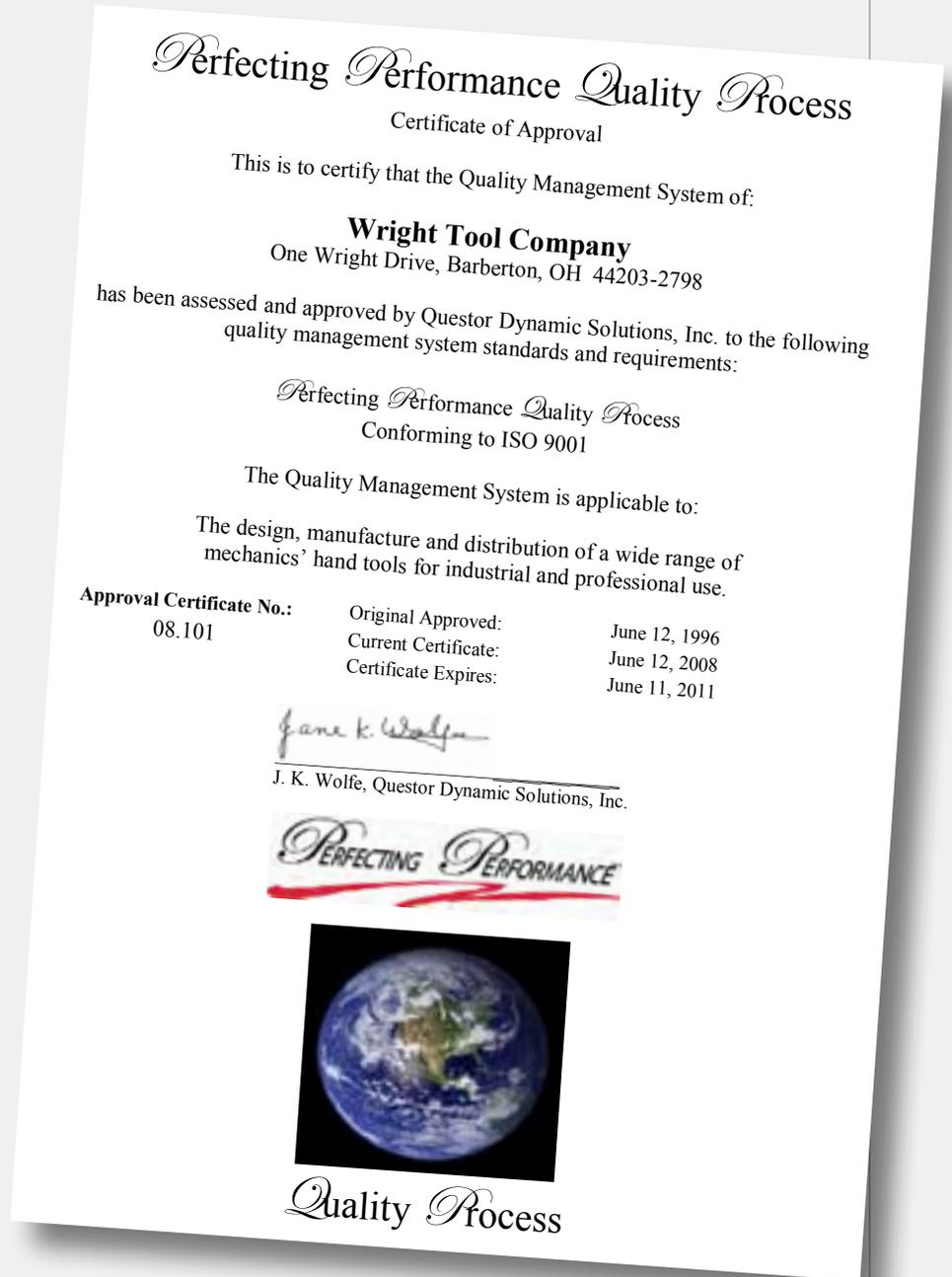



WRIGHT TOOL.



WRIGHT TOOL
PERFECTING PERFORMANCE™

At Wright Tool, we manufacture products for professionals—those who earn a living using tools they know they can depend on. From mechanics and maintenance professionals...to those who purchase tools for the non-residential construction, power petroleum/fossil fuels and heavy equipment/machinery markets...our customers know they can depend on Wright.

We manufacture the best-performing tools to get their jobs done safely, by providing the highest-engineered tools forged from specially formulated steel.

The reasons for buying Wright Tool are many. And it's those reasons that set us apart from our competition.



VALUE

We have been at the same location since our beginning in 1927. But even though the location hasn't changed, things are constantly evolving inside our facility as we strive for perfection.

"Perfecting Performance™" is our company mantra. It's never-ending, and we work diligently everyday to make sure we are providing you with the best tools in the business.

When you buy a Wright tool, you get exactly what you pay for—the highest-quality tool that has real value for the money. We recognize that value is more than just the price you pay. It's the whole package...from delivery...to service...to the high-quality tool that helps you get your job done safely.

We recognize that our customers are professionals, and pros can't afford to waste time or money on tools that fail. If an inexpensive tool fails, then it's not really an inexpensive tool. Downtime, repair costs and replacement costs all add up to the total cost.

Value is not the price of the *tool*. Value is the price of the *job*. At Wright, we price our tools to give you more value for your money. When you consider a job's total installation or dismantling costs, there are many more factors involved than the price paid for a tool. Our tools are not inexpensive, but they *are* cost-effective. And that's invaluable.

QUALITY

There's only one level of quality at Wright Tool. Every single one of our tools has the same premium, professional quality. And our customers know it.

The Wright® professional hand tool line is the industry's premier line in terms of quality. And the Wright brand is recognized throughout the hand tool industry as the standard for professionals.

All of our tools are made from WrightAlloy® steel. They are hot-forged, so the metal's inherent strength and quality characteristics are enhanced. The result is a tool that provides outstanding performance and long-lasting service.

We're better able to maintain our high standards because all of our operations are in-house, under one roof. To further ensure quality, all Wright products are carefully inspected and verified in accordance with international standards, as well as our own quality system that goes beyond ISO 9001/2000. As an industry leader, we've not only set the standards that others follow, we continually raise the bar to make the best even better.





INNOVATION

Wright Tool has always been at the forefront of the hand tool industry when it comes to new ideas. Our innovations are not just in the design and engineering of our tools, but in the forging, the finishing, the service and delivery.

Innovations such as the Wright Drive™ and WrightGrip™ have resulted in more tool-to-fastener contact, better fastener torque load and longer tool life.

Our design/engineering team utilizes the latest CAD/CAM technology in designing innovative new products. That's why Wright holds so many patents on innovative tools.

SAFETY

Safety has always been a reason to buy Wright. We take extra steps to build tools that are safer to use and designed to prevent tool failure. We engineer our tools for higher strength, better performance, longer-lasting durability and long-term reliability.

Some might say that we “over-engineer” our tools. We take that as a compliment. Where others might make a tool thinner to fit a tight space, we've designed a way to make the tool fit without sacrificing strength or contact area.

We are always looking out for the users of our products. We know that you need the safest possible tools in your arsenal. That's why we don't stop with “good enough.” We constantly strive to make our tools the safest in the industry.

DELIVERY

When it comes to delivery, nobody beats Wright Tool. Our delivery is not just prompt, it's the best in the industry. We offer better than 98% order fulfillment in 36 hours or less. That delivery record doesn't happen by accident.

We place a high-priority on meeting delivery deadlines. Our 98/36 record is great for distributors too, because it lets them do more and carry less inventory. Distributors that stock the Wright brand know they can deliver the product as promised.

98/36

SERVICE/SUPPORT

At Wright Tool, every customer is a “preferred” customer. Our customer service is prompt, friendly and knowledgeable. We want to assure your complete satisfaction. We can answer questions and solve problems over the phone...by e-mail...or in-person.

We offer our customers extras that others don't. From technical assistance to sales support, we go out of our way to support those with whom we do business.

As for our distributors, we've always treated them as partners. They're the vital link between our customers and Wright Tool. Our process ensures that the flow of products from manufacturer to distributor to customer is a smooth one. It's just another way we reinforce our valued distributors. And, it's another of the many reasons why we get high marks when it comes to distributor support.

“We have a staff of truly skilled, dedicated employees here at Wright Tool.

In fact, our work force averages 15 years of long service. That's a lot of knowledge and experience working for our customers.”

—Pat Taylor, Vice-President, Human Resources





Table of Contents

ASME/Warranty/Quality Process 5

Alphabetical Index 9

Master Sets..... 11
See page 333 for Contents of Master Sets

Tool Chests, Cabinets & Boxes 31

Wrenches 53

 Wrench Sets 56

 Wrenches 74

Sockets, Ratchets & Attachments 99

1/4" Drive

 Socket Sets 103

 Ratchets, Handles & Attachments 108

 Sockets 111

3/8" Drive

 Socket Sets 118

 Ratchets, Handles & Attachments 136

 Sockets 143

1/2" Drive

 Socket Sets 158

 Ratchets, Handles & Attachments 172

 Sockets 178

3/4" Drive

 Socket Sets 193

 Ratchets, Handles & Attachments 200

 Sockets 205

1" Drive

 Socket Sets 218

 Ratchets, Handles & Attachments 219

 Sockets 223

1-1/2" Drive

 Attachments 231

 Sockets 233

2-1/2" Drive

 Sockets 238

#5 Spline Drive

 Sockets 240

Torque Wrenches & Tools 243

 Torque Wrenches & Tools 246

 Torque Wrench Warranty 253

Screwdrivers & Nut Drivers 259

 Screwdriver Sets 261

 Screwdrivers 263

 Nut Driver Sets 266

 Nut Drivers 268

Hex Keys 269

 Hex Sets 271

 T-Handle Sets 278

 Ball Driver Sets 280

Pliers & Snips 283

 Pliers 285

 Snips 293

Hammers, Punches & Chisels 299

 Hammers 301

 Punch & Chisel Sets 305

 Punches & Chisels 310

Clamps 315

 Clamps 317

Miscellaneous Tools & Accessories 319

Contents of Master Sets 331
See page 13 for Photographs of Master Sets

Conversion Chart 360

Bolt Sizing Chart 362

Safety Fit Table 363

Ret Ring Interchange 364

Wright Tool Display Boards 365

 Display Boards 367

 Contents of Display Boards 377

Numerical Index 389

Safety Information 399

Special Tool Request 405



Alpha Index

Bolt & Wrench Sizing Charts	362
Boxes	
Cabinets, Chest, Trays & Utility Boxes.....	31-47, 49-50
Replacement Lock & Key Sets	48
Chisels/All Types/Mayhew	305-314
C-Clamps	
Deep Throat, Heavy Service, Extra Heavy Service, Instant-Action, Superclamps.....	315-318
Conversion Chart	360-361
Clip Rails	51
Crowfoot Wrenches	
Open End & 12 Pt.	141-142, 177
Display Boards	365-388
Drive Handles & Attachments, Adaptors, Extensions, Spinners, Speeders & Universals	
1/4" Drive	108-109
3/8" Drive	138-142
1/2" Drive	174-177
3/4" Drive	200-204
1" Drive.....	219-222
1-1/2" Drive.....	231-232
Drum Cap Opening Tool	98, 329
Feeler Gauges	327-328
Hacksaw	
Hacksaw	328
Replacement Blades.....	329
Hammers	
Ball Peen	302
Brass.....	301
Claw/Ripping	302
Cross Peen.....	303
Dead Blow.....	301
Drilling.....	303
Replacement Tips.....	302
Rubber Mallet.....	301
Sledge.....	303-304
Soft Face	301
HTI Safety Book	326
Inspection Mirrors	330

Magnetic Pick-Up Tool	329
Measuring (Steel) Tapes	328
Metal Cutting Snips	297
Nail Pullers/Mayhew	311, 314
Nut Drivers	266-268
Numerical Index	389-398
Patents & Trademarks	404
Picks, Hooks & Awls	324
Pliers/Channellock/Visc Grip	
Cable Cutter.....	289
Cutter/Stripper.....	287
Cutting.....	289, 292
Fence Tool.....	296
Hose Clamp	296
Locking/Visc Grip	293-295
Linemens.....	288, 291
Long Nose.....	289, 291
Oil Filter/PVC Pipe	290
Slip Joint.....	292
Snap Ring	285-286
Snips.....	297
Tongue & Groove.....	288, 290
Wire Crimping.....	289, 296
Wire Twisting.....	287
Pry Bars/Mayhew	311-312
Pullers/Spreaders	
Flange Jacks	90, 321
Punches/All Types/Mayhew	305-314
Racks, Wrench	52
Ratchets	
1/4" Drive	108
3/8" Drive	136-137
1/2" Drive	172-173
3/4" Drive	200
1" Drive.....	219
Construction Spud.....	91, 172
Scaffold	172
Track	200, 219
Utility/Raised Cap	137, 173
Ret Ring Interchange Chart	364
Safety Video, Book & Goggles	326





Scrapers & Knives/Hyde	325
Screwdrivers/Big Grip/Cushion Grip	
Cabinet Tip, Phillips, Round Shank, Square Shank, Four Way/Flip	263, 265
Screwdriver Sets.....	261-262
Sets	
1/4" Drive	103-107
3/8" Drive	118-135
1/2" Drive	158-171
3/4" Drive	193-199
1" Drive.....	218
Ball Nut Driver.....	266-268
Box Wrench.....	70
Combination Wrench	56-64
Crowfoot.....	127, 164
Flare Nut Wrench.....	69
Hex "L" Key, Hex "T" Key, Hex Folding Key, Hex Ball Driver.....	271-282
Master.....	13-30
Master Contents.....	331-358
Metric Flare Nut Wrench	69
Metric Ratcheting Box Wrench	71-72
Miniature Combination & Open-End Wrench.....	66-68
Open-End Wrench	64-66
Punch & Chisel	305-309
Ratcheting Box Wrench.....	71-72
Ratcheting Flare Nut Wrench.....	72
Screw Extractor.....	326
Screwdriver.....	261-262
Service Wrench.....	70
Spanner Wrench.....	72
Torx.....	155, 321
Torx Ball Driver	282
Snips/Midwest	297
Socket Retaining Rings/Pins & "O" Rings	203-204, 221-222, 232
Sockets	
1/4" Drive	111-114
3/8" Drive	143-152
1/2" Drive	178-190
3/4" Drive	205-216
1" Drive.....	223-229
1-1/2" Drive.....	233-237
2-1/2" Drive.....	237-239
#5 Spline Drive.....	240-241

Ball Joint	216
1/4" Drive Hex Bit	115
3/8" Drive Hex Bit	153-154
1/2" Drive Hex Bit	189-190
3/4" Drive Hex Bit	215-216
1" Drive Hex Bit.....	231
Penta.....	189
Railroad	228
Screwdriver.....	115-116, 155
Spark Plug	144, 179
Special Tool Request Form	405
Stud Remover	321
Tool Rolls & Pouches	51
Torque Tools	
Angle Method	249
Multipliers	254-257
Screwdrivers.....	253
Tester	258
Wrenches	246-252
Torx	
Sockets, Bits & Holders	322-323
1/4" Drive	117
3/8" Drive	156
1/2" Drive	191
Utility Knives/Hyde	325
Warranty	5
Wrenches	
Adjustable	88
Adjustable Construction	91
Box End	82
Combination	74-79
Construction (Structural, Spud).....	90-91
Crowfoot.....	85-86
Drum Cap Opening Tool	98
Engineer's.....	89
Flare Nut.....	83-84
Open-End	79-81
Pipe.....	89
Ratcheting Box.....	95-97
Ratcheting Flare Nut.....	84
Service.....	86
Spanner	87
Striking Face Box.....	93-95





Wright Tool Company offers an impressive selection of

Master Sets for professionals. From our Mega Master

Set with over 560 tools to our smaller Apprentice and

Basic Service Sets, there's something for everyone—even

metric sets. Each set contains quality tools, carefully

selected according to need and coverage.



MASTER SETS.





Master Sets

ASME B107.100 – Flat Wrenches

ASME B107.110 – Socket Wrenches

ASME B107.400 – Striking Tools/Hammers

ASME 107.410 – Struck Tools

ASME B107.500 – Pliers

ASME B107.510 – Pliers and Shears

ASME B107.600 – Screwdrivers

Mega Fractional Master Set

WRIGHT TOOL
PERFECTING PERFORMANCE



Mega Fractional Master Set—1/4", 3/8", 1/2" & 3/4" Drives

Set No. 101 –

447 Pieces including WT710 Ten Drawer Chest
& WT796 Eight Drawer Roller Cabinet

Set No. 102 –

445 Pieces
(Tools Only - Cabinets Not Included)

See Page 333 for contents.



WT710 & WT796 for Set No. 101

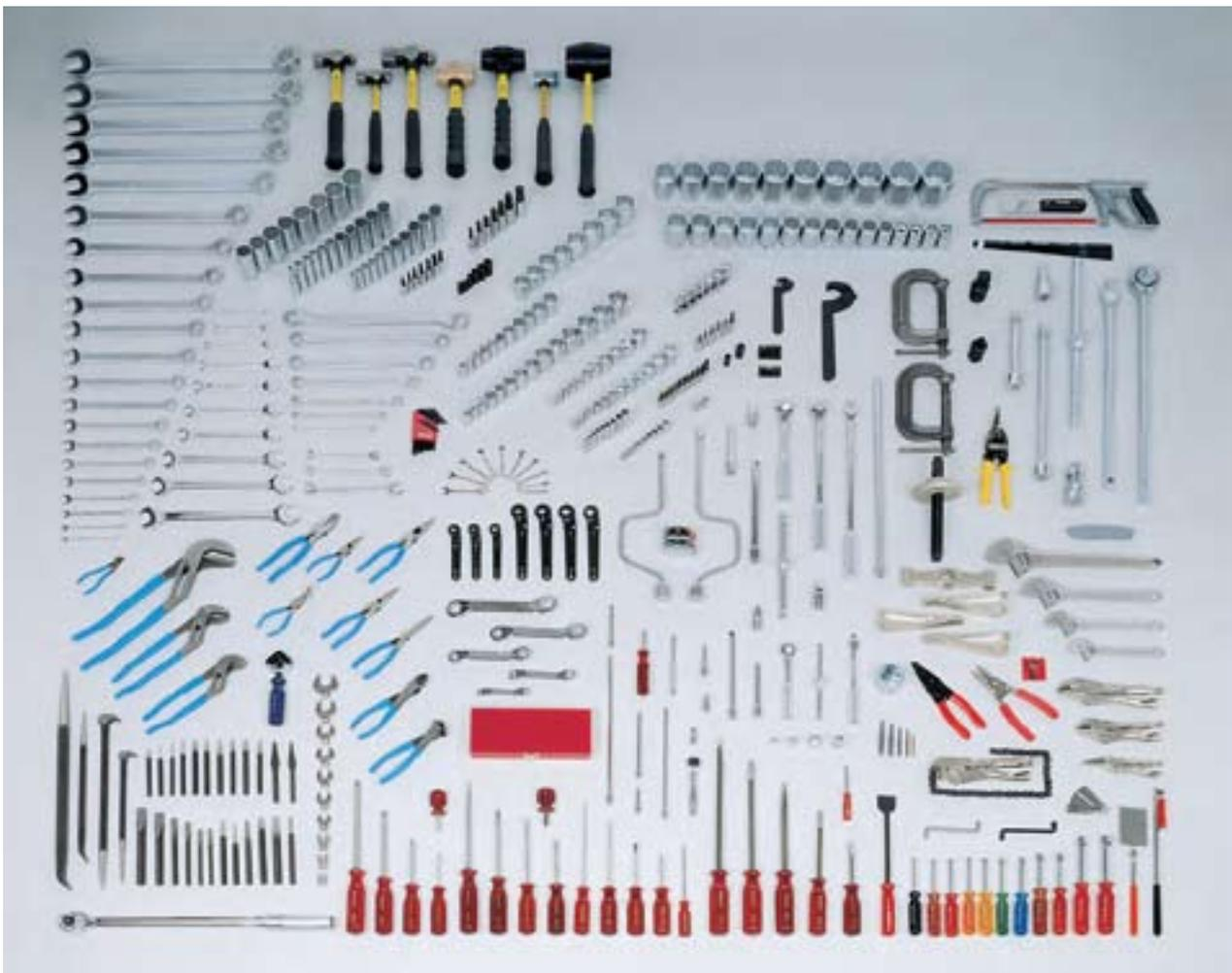

WARNING
Wear safety goggles user and bystander.



WARNING
Before using tools, read safety information on pages 399-403.



WARNING
Comfort or plastic grips do not protect against electric shock.





Mega Fractional/Metric Master Set—1/4", 3/8", 1/2" & 3/4" Drives

Set No. 105 –

561 Pieces including WT861 Nine Drawer
42" Top Chest & WT854 Fifteen Drawer
42" Roller Cabinet

Set No. 107 –

559 Pieces
(Tools Only - Cabinets Not Included)

See Page 335 for contents.



WT861 & WT854 for Set No. 105

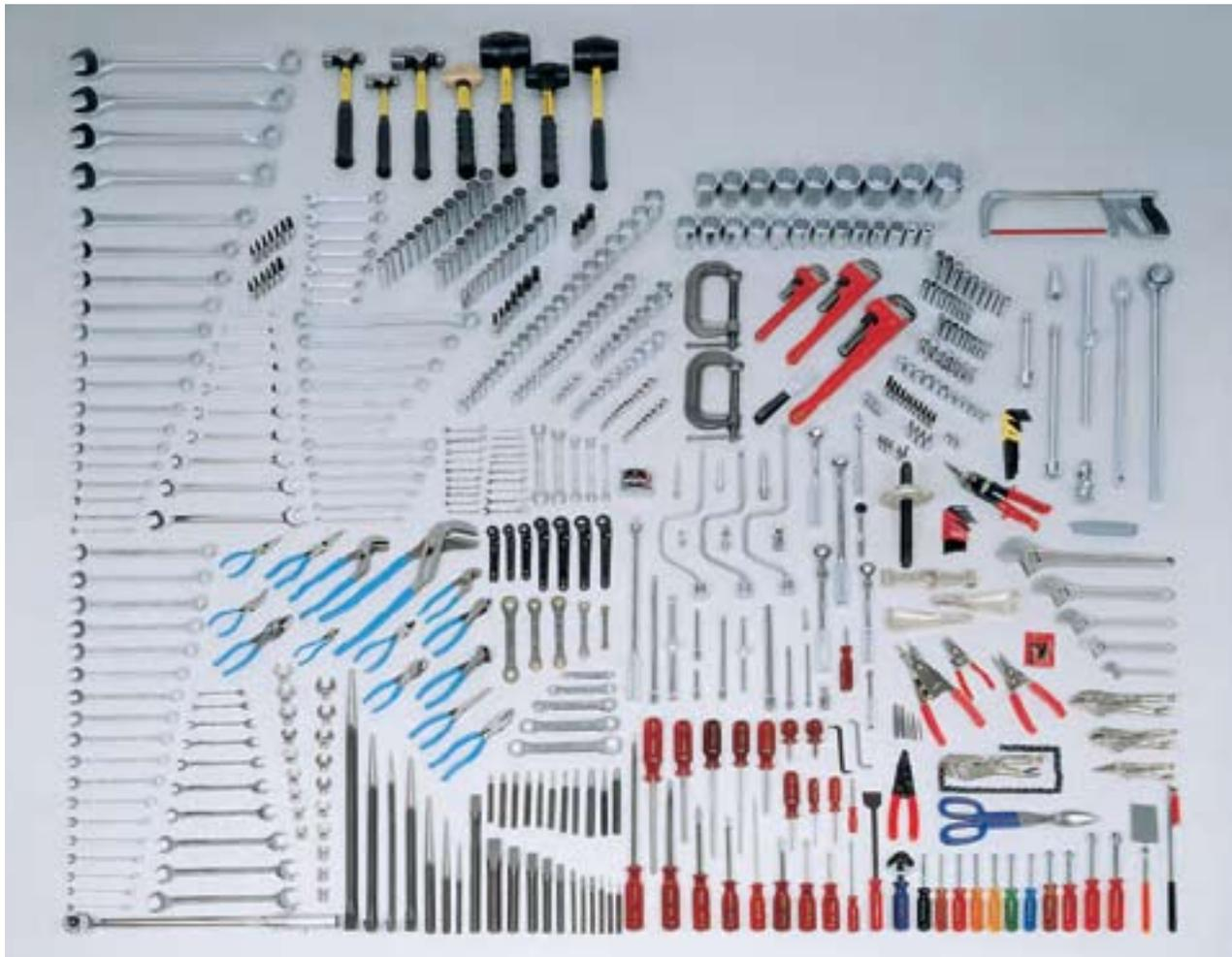

Master Sets





Master Fractional/Metric Set—1/4", 3/8", 1/2" & 3/4" Drives

Set No. 112 –

283 Pieces including WT814 Twelve
Drawer Chest & WT896 Eleven Drawer
Roller Cabinet

Set No. 113 –

281 Pieces
(Tools Only - Cabinets Not Included)

See Page 338 for contents.





Master Maintenance Set-1/4", 3/8" & 1/2" Drives

Set No. 121 -

374 Pieces including WT814 Twelve Drawer Chest & WT896 Eleven Drawer Roller Cabinet

Set No. 122 -

372 Pieces
(Tools Only - Cabinets Not Included)

See Page 340 for contents.



Master Sets





Intermediate Set—1/4", 3/8", 1/2" & 3/4" Drives

Set No. 125 –

256 Pieces including WT796
Eight Drawer Roller Cabinet

See Page 342 for contents.

Set No. 126 –

255 Pieces
(Tools Only - Cabinet Not Included)



WARNING
Wear safety goggles user and bystander.



WARNING
Before using tools, read safety information on pages 399-403.



WARNING
Comfort or plastic grips do not protect against electric shock.



Intermediate Set-1/4", 3/8" & 1/2" Drives

Set No. 130 –
220 Pieces including WT814 Twelve
Drawer Chest

Set No. 131 –
219 Pieces
(Tools Only - Cabinet Not Included)

See Page 344 for contents.



Master Sets





General Maintenance Set—1/4", 3/8" & 1/2" Drives

Set No. 135 –

135 Pieces including WT523 Three Drawer Chest

Set No. 136 –

134 Pieces
(Tools Only - Cabinet Not Included)

See Page 346 for contents.



Master Sets



WARNING
Wear safety goggles user and bystander.



WARNING
Before using tools, read safety information on pages 399-403.



WARNING
Comfort or plastic grips do not protect against electric shock.



Mechanics Set-1/4", 3/8" & 1/2" Drives

Set No. 140 –

140 Pieces including WT524 Two Drawer Portable Chest

See Page 347 for contents.

Set No. 141 –

**139 Pieces
(Tools Only - Cabinet Not Included)**



Master Sets





General Service Set—1/4", 3/8" & 1/2" Drives

Set No. 150 –

132 Pieces including WT520 Heavy-Duty Mechanic's Box with Tray

Set No. 152 –

131 Pieces
(Tools Only - Box Not Included)

See Page 348 for contents.



Master Sets



WARNING
Wear safety goggles user and bystander.



WARNING
Before using tools, read safety information on pages 399-403.



WARNING
Comfort or plastic grips do not protect against electric shock.



Basic Service Set-1/4", 3/8" & 1/2" Drives

Set No. 160 –
99 Pieces including WT520 Heavy-Duty
Mechanic's Box with Tray

Set No. 161 –
98 Pieces
(Tools Only - Box Not Included)

See Page 349 for contents.



Master Sets





Starter Set—3/8" & 1/2" Drives

Set No. 165 –

97 Pieces Including WT520 Heavy-Duty Mechanic's Box with Tray

See Page 350 for contents.

Set No. 166 –

96 Pieces
(Tools Only - Box Not Included)



Master Sets





Apprentice Set-3/8" Drive

Set No. 170 –
54 Pieces Including WT520 Heavy-Duty
Mechanic's Box with Tray

See Page 351 for contents.

Set No. 171 –
53 Pieces
(Tools Only - Box Not Included)



Master Sets

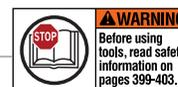



Industrial Maintenance Set—1/4", 3/8" & 1/2" Drives

Set No. 180 –

114 Pieces Including WT803 Six Drawer Chest with Tray

See Page 352 for contents.

Set No. 181 –

113 Pieces
(Tools Only - Chest Not Included)



Master Sets





Aircraft Mechanic's Starter Set—1/4", 3/8" & 1/2" Drives

Set No. 185 –

107 Pieces Including WT523 Three
Drawer Chest

Set No. 186 –

106 Pieces
(Tools Only - Chest Not Included)

See Page 353 for contents.



Master Sets





Metric Add-On Set—1/4", 3/8" & 1/2" Drives

Set No. 189 – 151 Pieces (Tools Only)

See Page 354 for contents.



Master Sets



WARNING
Wear safety goggles user and bystander.



WARNING
Before using tools, read safety information on pages 399-403.



WARNING
Comfort or plastic grips do not protect against electric shock.



Master Metric Maintenance Set—1/4", 3/8" & 1/2" Drives

Set No. 190 –

264 Pieces Including WT814 Twelve Drawer Chest & WT896 Eleven Drawer Roller Cabinet

Set No. 191 –

262 Pieces
(Tools Only - Cabinets Not Included)

See Page 355 for contents.



Master Sets





Metric Service Set—1/4", 3/8" & 1/2" Drives

Set No. 194 –
123 Pieces Including WT523 Three
Drawer Chest

Set No. 195 –
122 Pieces
(Tools Only - Cabinet Not Included)

See Page 357 for contents.



Master Sets





Metric Apprentice Set—3/8" & 1/2" Drives

Set No. 199 –

**75 Pieces Including WT528
Tool Box with Tray**

See Page 358 for contents.



Master Sets





From our 19" tool box to our large multi-drawer roller cabinets, Wright provides a full array of rugged tool storage products. All tool chests, cabinets and boxes are constructed of quality steel. Other features include powder coat paint for superior scratch/chemical resistance, double wall construction for great strength, optional colors on some models and specially designed shipping boxes to avoid damage.



TOOL CHESTS, CABINETS & BOXES.





W A R N I N G !

TOOL STORAGE UNIT (boxes, chests, cabinets)

- Users and bystanders must wear safety goggles.
- To avoid possible eye injury from flying objects, safety goggles or equivalent protection conforming to ANSI Z87.1 shall be worn and kept clean by the user and all persons in the immediate area where any tool is being used.
- Do not stand or climb on drawers.
- Do not open more than one drawer at a time.
- Never pull your tool storage unit. Always push so you can see the direction you are traveling and avoid obstacles. Move tool storage units in a controlled manner on smooth, level surfaces.
- Never use a tool storage unit for an anvil, workbench, ladder, or similar purpose.
- Do not stand on tool boxes, tool chests or tool cabinets.
- Do not overload drawers.
- Do not move a tool storage unit without locking or securing all drawers or lids.
- Never leave tools unattended on top of a tool storage unit.
- Make sure that wheels on tool storage units turn freely.
- Set the brakes on locking casters when the storage unit is at the work area.



Double lid support brackets prevent accidental closing.

Reinforced lid provides greater rigidity for years more service.

Internal, secure, locking mechanism for chests and cabinets.

Coded lock with replacement keys.

Full length piano hinge.

Metal gauge top chest:

Case and lid – 18 gauge; Drawers – 20 gauge.

Welded side handles, top chest.

Heavy-duty metal slides, optional smooth roller bearing slide.

Shipped in specially designed boxes to avoid damage.

Optional colors available on some models as a special order.



Heavy gauge metal that lasts a lifetime.

Double-wall construction for greater strength.

Powder coat paint for superior scratch- and chemical-resistance.

Metal gauge roller cabinets:

Bottom – 16 gauge; Sides, inside sides and top – 18 gauge; Drawers – 20 gauge.

Heavy-duty casters, two swivel with brakes. Two are fixed for safe mobile tool storage.

Heavy duty, full length drawer pulls.

Spacious compartments to store bulky tools.

Plated side handle fits either side.





**Nine Drawer Top Chest
 (with Roller Bearing Slides)
 WT962 (Red)**

52-17/32" W (133,4) 17-7/8" D (45,4)
 22-1/4" H (56,5) 185 lbs. (84 kg)

- All drawers have smooth roller bearing slides.
- Internal, secure, locking mechanism for chests and cabinets.
- Heavy duty, full length drawer pulls.
- Welded side handles, top chest.
- Double lid support brackets.
- Metal gauge top chest: Case and lid – 18 gauge; Drawers – 20 gauge.

	Width in(cm)	Depth in(cm)	Height in(cm)
Overall	52-17/32" (133,4)	17-7/8" (45,4)	22-1/4" (56,5)
2 Drawers	23" (58,4)	16" (40,6)	2" (5,1)
1 Drawer	23" (58,4)	16" (40,6)	4-1/4" (10,8)
1 Drawer	23" (58,4)	16" (40,6)	6-7/16" (16,4)
3 Drawers	23" (58,4)	16" (40,6)	2" (5,1)
2 Drawers	23" (58,4)	16" (40,6)	4-1/4" (10,8)

Storage Capacity: 13542 in³ (221820 cm³)



**Fourteen Drawer Roller Cabinet
 (with Roller Bearing Slides)
 WT952 (Red)**

53-17/32" W (135,7) 18-3/4" D (47,6)
 42-3/8" H (107,6) 347 lbs. (158 kg)

- All drawers have smooth roller bearing slides.
- Internal, secure, locking mechanism for chests and cabinets.
- Heavy duty, full length drawer pulls.
- Welded side handles, top chest.
- Double lid support brackets.
- Metal gauge roller cabinets: Bottom – 16 gauge; Sides, inside sides and top – 18 gauge; Drawers – 20 gauge.

	Width in(cm)	Depth in(cm)	Height in(cm)
Overall	53-17/32" (135,7)	18-3/4" (47,6)	42-3/8" (107,6)
2 Drawers	23" (58,4)	16" (40,6)	4-1/4" (10,8)
4 Drawers	23" (58,4)	16" (40,6)	2" (5,1)
4 Drawers	23" (58,4)	16" (40,6)	4-1/4" (10,8)
1 Drawer	23" (58,4)	16" (40,6)	4-1/4" (10,8)
1 Drawer	23" (58,4)	16" (40,6)	8-1/2" (21,6)
2 Drawers	23" (58,4)	16" (40,6)	6-7/16" (16,4)

Storage Capacity: 21100 in³ (345617 cm³)

Wheels: 5" (12,5 cm) x 2" (5 cm) frame 12 gauge





Nine Drawer Top Chest (with Roller Bearing Slides) WT865

41-1/2" W (105,4) 23" D (58,4)
21-1/8" H (53,7) 243 lbs. (110,5 kg)

- All drawers have smooth roller bearing slides.
- Internal, secure, locking mechanism for chests and cabinets.
- Heavy duty, full length drawer pulls.
- Welded side handles, top chest.
- Double lid support brackets.
- Metal gauge top chest: Case and lid – 18 gauge; Drawers – 20 gauge.

WT865 (Red)

	Width in(cm)	Depth in(cm)	Height in(cm)
Overall	41-1/2" (105,4)	23" (58,4)	21-1/8" (53,7)
1 Drawer	11" (27,9)	22" (55,9)	6-7/16" (16,4)
1 Drawer	11" (27,9)	22" (55,9)	4-1/4" (10,8)
2 Drawers	11" (27,9)	22" (55,9)	2" (5,1)
2 Drawers	23" (58,4)	22" (55,9)	4-1/4" (10,8)
3 Drawers	23" (58,4)	22" (55,9)	2" (5,1)

Storage Capacity: 13090 in³ (217714 cm³)



Thirteen Drawer Roller Cabinet (with Roller Bearing Slides) WT855

41-1/2" W (105,4) 24-3/8" D (62)
43-5/8" H (110,8) 422 lbs. (191,8 kg)

- All drawers have smooth roller bearing slides.
- Internal, secure, locking mechanism for chests and cabinets.
- Heavy duty, full length drawer pulls.
- Welded side handles, top chest.
- Double lid support brackets.
- Metal gauge roller cabinets: Bottom – 16 gauge; Sides, inside sides and top – 18 gauge; Drawers – 20 gauge.

WT855 (Red)

	Width in(cm)	Depth in(cm)	Height in(cm)
Overall	41-1/2" (105,4)	24-3/8" (62)	43-5/8" (110,8)
1 Drawer	38" (96,5)	22" (55,9)	4-1/4" (10,8)
4 Drawers	23" (58,4)	22" (55,9)	2" (5,1)
2 Drawers	23" (58,4)	22" (55,9)	4-1/4" (10,8)
1 Drawer	23" (58,4)	22" (55,9)	6-7/16" (16,4)
3 Drawers	11" (27,9)	22" (55,9)	2" (5,1)
1 Drawer	11" (27,9)	22" (55,9)	4-1/4" (10,8)
1 Drawer	11" (27,9)	22" (55,9)	13" (33)

Storage Capacity: 19938 in³ (326584 cm³)

Wheels: 6" (15 cm) x 2" (5 cm) frame 8 gauge





**Seven Drawer Top Chest
(with Roller Bearing Slides)
WT877**

40-1/2" W (102,9) 17-7/8" D (45,4)
20-1/2" H (52,1) 145 lbs. (65,9 kg)

- All drawers have smooth roller bearing slides.
- Internal, secure, locking mechanism for chests and cabinets.
- Heavy duty, full length drawer pulls.
- Welded side handles, top chest.
- Double lid support brackets.
- Metal gauge top chest: Case and lid – 18 gauge; Drawers – 20 gauge.

WT877 (Red) • WT877B (Black) • WT877BL (Blue)

	Width in(cm)	Depth in(cm)	Height in(cm)
Overall	40-1/2" (102,9)	17-7/8" (45,4)	20-1/2" (52,1)
2 Drawers	23" (58,4)	16" (40,6)	2" (5,1)
2 Drawers	11" (27,9)	16" (40,6)	2" (5,1)
1 Drawer	23" (58,4)	16" (40,6)	4-1/4" (10,8)
1 Drawer	11" (27,9)	16" (40,6)	4-1/4" (10,8)
1 Drawer	38" (96,5)	16" (40,6)	4-1/4" (10,8)

Storage capacity: 9205 in³ (150778 cm³)



**Fifteen Drawer Roller Cabinet
(with Roller Bearing Slides)
WT854R**

41-1/2" W (105,4) 18-3/4" D (47,6)
42-3/8" H (107,6) 255 lbs. (115,9 kg)

- All drawers have smooth roller bearing slides.
- Internal, secure, locking mechanism for chests and cabinets.
- Heavy duty, full length drawer pulls.
- Welded side handles, top chest.
- Double lid support brackets.
- Metal gauge roller cabinets: Bottom – 16 gauge; Sides, inside sides and top – 18 gauge; Drawers – 20 gauge.

WT854R (Red) • WT854RB (Black) • WT854RBL (Blue)

	Width in(cm)	Depth in(cm)	Height in(cm)
Overall	41-1/2" (105,4)	18-3/4" (47,6)	42-3/8" (107,6)
1 Drawer	38" (96,5)	16" (40,6)	4-1/4" (10,8)
4 Drawers	23" (58,4)	16" (40,6)	2" (5,1)
2 Drawers	23" (58,4)	16" (40,6)	4-1/4" (10,8)
1 Drawer	23" (58,4)	16" (40,6)	6-7/16" (16,4)
4 Drawers	11" (27,9)	16" (40,6)	2" (5,1)
2 Drawers	11" (27,9)	16" (40,6)	4-1/4" (10,8)
1 Drawer	11" (27,9)	16" (40,6)	6-7/16" (16,4)

Storage Capacity: 14623 in³ (239525 cm³)

Wheels: 5" (12,5 cm) x 2" (5 cm) frame 12 gauge





Nine Drawer 42" Top Chest WT861

40-1/2" W (102,9 cm) 17-7/8" D (45,4 cm)
20-1/2" H (52,1 cm) 137 lbs. (62,3 kg)

- Internal, secure, locking mechanism for chests and cabinets.
- Heavy duty, full length drawer pulls.
- Welded side handles, top chest.
- Double lid support brackets.
- Metal gauge top chest: Case and lid – 18 gauge; Drawers – 20 gauge.

WT861 (Red)

	Width in (cm)	Depth in (cm)	Height in (cm)	Weight
Overall	40-1/2" (102,9)	17-7/8" (45,4)	20-1/2" (52,1)	137 lb. (62,3 kg)
4 Drawers	23" (58,4)	16" (40,6)	2" (5,1)	
4 Drawers	11" (27,9)	16" (40,6)	2" (5,1)	
1 Drawer	38" (96,5)	16" (40,6)	4-1/4" (10,8)	

Storage Capacity: 9,205 in³ (150778 cm³)



Fifteen Drawer 42" Roller Cabinet WT854

41-1/2" W (105,4 cm) 42-3/8" H (107,6 cm)
18-3/4" D (47,6 cm) 226 lbs. (102,7 kg)

- Internal, secure, locking mechanism for chests and cabinets.
- Heavy duty, full length drawer pulls.
- Welded side handles, top chest.
- Double lid support brackets.
- Metal gauge roller cabinets: Bottom – 16 gauge; Sides, inside sides and top – 18 gauge; Drawers – 20 gauge.

WT854 (Red)

	Width in (cm)	Depth in (cm)	Height in (cm)	Weight	Wheels in (cm)
Overall	41-1/2" (105,4)	18-3/4" (47,6)	42-3/8" (107,6)	226 lb. (102,7 kg)	5" (12,5) x 2" (5) frame
4 Drawers	23" (58,4)	16" (40,6)	2" (5,1)		12 ga.
4 Drawers	11" (27,9)	16" (40,6)	2" (5,1)		2 swivels, 2 rigids
2 Drawers	23" (58,4)	16" (40,6)	4-1/4" (10,8)		
2 Drawers	11" (27,9)	16" (40,6)	4-1/4" (10,8)		
1 Drawer	23" (58,4)	16" (40,6)	6-7/16" (16,4)		
1 Drawer	11" (27,9)	16" (40,6)	6-7/16" (16,4)		
1 Drawer	38" (96,5)	16" (40,6)	4-1/4" (10,8)		

Storage Capacity: 14623 in³ (239525 cm³)





**Ten Drawer Top Chest
(with Roller Bearing Slides)
WT710**

34" W (86,4 cm) 17-7/8" D (45,4 cm)
20-1/2" H (52,1 cm) 146 lbs. (66,4 kg)

- Drawer liners.
- Internal, secure, locking mechanism for chests and cabinets.
- Heavy duty, full length drawer pulls.
- Welded side handles, top chest.
- Double lid support brackets.
- Metal gauge top chest: Case and lid – 18 gauge; Drawers – 20 gauge.

	Width in (cm)	Depth in (cm)	Height in (cm)	Weight
Overall	34" (86,4)	17-7/8" (45,4)	20-1/2" (52,1)	146 lb. (66,4 kg)
6 Drawers	11" (27,9)	16" (40,6)	2" (5,1)	
1 Drawer	7" (17,8)	16" (40,6)	6-7/16" (16,4)	
2 Drawers	31" (78,7)	16" (40,6)	2" (5,1)	
Bearing				
1 Drawer	31" (78,7)	16" (40,6)	4-1/4" (10,8)	
Bearing				

Storage Capacity: 8845 in³ (14881 cm³)



**Eight Drawer Roller Cabinet
(with Roller Bearing Slides)
WT796**

35" W (88,9 cm) 18-3/4" D (47,6 cm)
42-3/8" H (107,6 cm) 218 lbs. (99 kg)

- Drawer liners.
- Top rubber mat.
- Internal, secure, locking mechanism for chests and cabinets.
- Heavy duty, full length drawer pulls.
- Welded side handles, top chest.
- Double lid support brackets.
- Metal gauge roller cabinets: Bottom – 16 gauge; Sides, inside sides and top – 18 gauge; Drawers – 20 gauge.

	Width in (cm)	Depth in (cm)	Height in (cm)	Weight
Overall	35" (88,9)	18-3/4" (47,6)	42-3/8" (107,6)	218 lb. (99 kg)
4 Drawers	31" (78,7)	16" (40,6)	2" (5,1)	
3 Drawers	31" (78,7)	16" (40,6)	4-1/4" (10,8)	
1 Drawer	31" (78,7)	16" (40,6)	8-1/2" (21,6)	

Storage Capacity: 14292 in³ (234103 cm³)





Six Drawer Top Chest (with Roller Bearing Slides) WT816 (Red)

26" W (66,0 cm) 20-1/2" H (52,1 cm)
17-7/8" D (45,4 cm) 103 lbs. (46,8 kg)

- All drawers have smooth roller bearing slides
- Internal, secure, locking mechanism for chests and cabinets.
- Heavy duty, full length drawer pulls.
- Welded side handles, top chest.
- Double lid support brackets.
- Metal gauge top chest: Case and lid – 18 gauge; Drawers – 20 gauge.

	Width in (cm)	Depth in (cm)	Height in (cm)	Weight
Overall	26" (66,0)	17-7/8" (30,5)	20-1/2" (52,1)	103 lb.(31,8 kg)
1 Drawers	23" (58,4)	16" (40,6)	4-1/4" (18,8)	
5 Drawer	23" (58,4)	16" (40,6)	2" (5,1)	

Storage Capacity: 6687 in³ (109582 cm³)



Eight Drawer Roller Cabinet (with Roller Bearing Slides) WT798 (Red)

27" W (68,6 cm) 18-3/4" D (47,6 cm)
42-3/8" H (107,6 cm) 161 lbs. (73,2 kg)

- All drawers have smooth roller bearing slides.
- Internal, secure, locking mechanism for chests and cabinets.
- Heavy duty, full length drawer pulls.
- Welded side handles, top chest.
- Double lid support brackets.
- Metal gauge roller cabinets: Bottom – 16 gauge; Sides, inside sides and top – 18 gauge; Drawers – 20 gauge.

	Width in (cm)	Depth in (cm)	Height in (cm)	Weight
Overall	27" (68,6)	18-3/4" (47,6)	42-3/8" (107,6)	161 lb. (73,2 kg)
1 Drawers	23" (58,4)	16" (40,6)	8-1/2" (21,6)	
3 Drawers	23" (58,4)	16" (40,6)	4-1/4" (10,8)	
4 Drawers	23" (58,4)	16" (40,6)	2" (5,1)	

Storage Capacity: 10560 in³ (172973 cm³)

Wheels: 5" (12,5 cm) x 2" (5 cm), 2 swivels, 2 ridgid





**Ten Drawer Top Chest
WT804**

26" W (66,0 cm) 18-7/8" H (48 cm)
12" D (30,5 cm) 70 lbs. (31,8 kg)

- Internal, secure, locking mechanism for chests and cabinets.
- Heavy duty, full length drawer pulls.
- Welded side handles, top chest.
- Double lid support brackets.
- Metal gauge top chest: Case and lid – 18 gauge; Drawers – 20 gauge.

WT804 (Red)

	Width in (cm)	Depth in (cm)	Height in (cm)	Weight
Overall	26" (66,0)	12" (30,5)	18-7/8" (48)	70 lb.(31,8 kg)
6 Drawers	7" (17,8)	10-1/2" (26,7)	2" (5,1)	
1 Drawer	7" (17,8)	10-1/2" (26,7)	6-7/16" (16,4)	
2 Drawers	23" (58,4)	10-1/2" (26,7)	2" (5,1)	
1 Drawer	23" (58,4)	10-1/2" (26,7)	2-1/2" (6,4)	

Storage Capacity: 4000 in³ (65520 cm³)



**Twelve Drawer Top Chest
WT814**

26" W (66,0 cm) 12" D (30,5 cm)
18-7/8" H (48 cm) 71 lbs. (32,3 kg)

- Internal, secure, locking mechanism for chests and cabinets.
- Heavy duty, full length drawer pulls.
- Welded side handles, top chest.
- Double lid support brackets.
- Metal gauge top chest: Case and lid – 18 gauge; Drawers – 20 gauge.

	Width in (cm)	Depth in (cm)	Height in (cm)	Weight
Overall	26" (66,0)	12" (30,5)	18-7/8" (48)	71 lb.(32,3 kg)
9 Drawers	7" (17,8)	10-1/2" (26,7)	2" (5,1)	
2 Drawers	23" (58,4)	10-1/2" (26,7)	2" (5,1)	
1 Drawer	23" (58,4)	10-1/2" (26,7)	2-1/2" (6,4)	

Storage Capacity: 3991 in³ (65373 cm³)





Six Drawer Drop Front Top Chest (with Friction Slides) WT503 (Red)

26" W (66,0) 12" D (30,5)
14-1/2" H (36,8) 57 lbs. (26 kg)

- Internal, secure, locking mechanism for chests and cabinets.
- Heavy duty, full length drawer pulls.
- Welded side handles, top chest.
- Double lid support brackets.
- Metal gauge top chest: Case and lid – 18 gauge; Drawers – 20 gauge.

	Width in(cm)	Depth in(cm)	Height in(cm)
Overall	26" (66,0)	12" (30,5)	14-1/2" (36,8)
1 Drawer	23" (58,4)	10-1/2" (26,7)	2-1/2" (6,4)
2 Drawers	23" (58,4)	10-1/2" (26,7)	2" (5,1)
3 Drawers	7" (17,8)	10-1/2" (26,7)	2" (5,1)

Storage Capacity: 3073 in³ (50336 cm³)



Ten Drawer Drop Front Top Chest (with Friction Slides) WT510 (Red)

26" W (66,0) 17-7/8" D (45,4)
20-1/2" H (52,1) 104 lbs. (47,2 kg)

- Internal, secure, locking mechanism for chests and cabinets.
- Heavy duty, full length drawer pulls.
- Welded side handles, top chest.
- Double lid support brackets.
- Metal gauge top chest: Case and lid – 18 gauge; Drawers – 20 gauge.

	Width in(cm)	Depth in(cm)	Height in(cm)
Overall	26" (66,0)	17-7/8" (45,4)	20-1/2" (52,1)
1 Drawer	23" (58,4)	16" (40,6)	4-1/4" (10,8)
2 Drawers	23" (58,4)	16" (40,6)	2" (5,1)
6 Drawers	7" (17,8)	16" (40,6)	2" (5,1)
1 Drawer	7" (17,8)	16" (40,6)	6-7/16" (16,4)

Storage Capacity: 6571 in³ (107633 cm³)





Three Drawer Intermediate Chest WT805

26-1/2" W (67,3 cm) 12" H (30,5 cm)
12-1/2" D (31,8 cm) 38 lbs. (17,3 kg)

- Internal, secure, locking mechanism for chests and cabinets.
- Heavy duty, full length drawer pulls.
- Welded side handles, top chest.
- Double lid support brackets.

WT805 (Red)

	Width in (cm)	Depth in (cm)	Height in (cm)	Weight
Overall	26-1/2" (67,3)	12-1/2" (31,8)	12" (30,5)	38 lb. (17,3 kg)
2 Drawers	23" (58,4)	10-1/2" (26,7)	2" (5,1)	
1 Drawer	23" (58,4)	10-1/2" (26,7)	4-1/4" (10,8)	

Storage Capacity: 11938 in³ (31744 cm³)



Eleven Drawer Roller Cabinet WT896

27" W (68,6 cm) 42-3/8" H (107,6 cm)
18-3/4" D (47,6 cm) 151 lbs. (68,6 kg)

- Internal, secure, locking mechanism for chests and cabinets.
- Heavy duty, full length drawer pulls.
- Welded side handles, top chest.
- Double lid support brackets.
- Metal gauge roller cabinets: Bottom – 16 gauge; Sides, inside sides and top – 18 gauge; Drawers – 20 gauge.

	Width in (cm)	Depth in (cm)	Height in (cm)	Weight	Wheels in (cm)
Overall	27" (68,6)	18-3/4" (47,6)	42-3/8" (107,6)	151 lb. (68,6 kg)	5" (12,5) x 2" (5)
4 Drawers	11" (27,9)	16" (40,6)	2" (5,1)		frame 12 ga.
4 Drawers	23" (58,4)	16" (40,6)	2" (5,1)		2 swivels, 2 rigids
2 Drawers	23" (58,4)	16" (40,6)	4-1/4" (10,8)		
1 Drawer	23" (58,4)	16" (40,6)	8-1/2" (21,6)		

Storage Capacity: 9595 in³ (157166 cm³)





Six Drawer Top Chest WT803

26" W (66,0 cm) 12" D (30,5 cm)
14-1/2" H (36,8 cm) 55 lbs. (25 kg)

- Internal, secure, locking mechanism for chests and cabinets.
- Heavy duty, full length drawer pulls.
- Welded side handles, top chest.
- Double lid support brackets.
- Metal gauge top chest: Case and lid – 18 gauge; Drawers – 20 gauge.

	Width in (cm)	Depth in (cm)	Height in (cm)	Weight
Overall	26" (66,0)	12" (30,5)	14-1/2" (36,8)	55 lb. (25 kg)
3 Drawers	7" (17,8)	10-1/2" (26,7)	2" (5,1)	
2 Drawers	23" (58,4)	10-1/2" (27,6)	2" (5,1)	
1 Drawer	23" (58,4)	10-1/2" (27,6)	2-1/2" (6,4)	

Storage Capacity: 3073 in³ (50336 cm³)



Three Drawer Roller Cabinet with Compartment WT899

27" W (68,6 cm) 35-5/8" H (90,5 cm)
18-3/4" D (47,6 cm) 90 lbs. (41 kg)

- Internal, secure, locking mechanism for chests and cabinets.
- Heavy duty, full length drawer pulls.
- Welded side handles, top chest.
- Double lid support brackets.
- Metal gauge roller cabinets: Bottom – 16 gauge; Sides, inside sides and top – 18 gauge; Drawers – 20 gauge.

	Width in (cm)	Depth in (cm)	Height in (cm)	Weight	Wheels in (cm)
Overall	27" (68,6)	18-3/4" (47,6)	35-5/8" (90,5)	90 lb. (41 kg)	5" (12,7) x 1-1/4"
1 Drawer	23" (58,4)	16" (40,6)	2" (5,1)		(3,1) frame 12 ga.
1 Drawer	23" (58,4)	16" (40,6)	4-1/4" (10,8)		2 swivels, 2 rigids
1 Drawer	23" (58,4)	16" (40,6)	6-7/16" (16,4)		

Storage Capacity: 10472 in³ (171548 cm³)





**Side Cabinet Locker
 (with Roller Bearing Slides)
 WT834**

17-3/4" W (45,1) 18-3/4" D (47,6)
 56-15/16" H (144,6) 105 lbs. (47,7 kg)

- All drawers have smooth roller bearing slides.

WT844 (Red) • WT844B (Black) • WT844BL (Blue)

	Width in(cm)	Depth in(cm)	Height in(cm)
Overall	17-3/4" (45,1)	18-3/4" (47,6)	56-15/16" (144,6)
Drawers	11" (27,9)	16" (40,6)	6-7/16" (16,4)

Storage Capacity: 12258 in³ (199924 cm³)





21" Three Drawer Chest WT523

21" W (53,3 cm) 8-3/4" D (22,2 cm)
12" H (30,5 cm) 23 lbs. (10 kg)

	Width in (cm)	Depth in (cm)	Height in (cm)	Weight
Overall	21" (53,3)	8-3/4" (22,2)	12" (30,5)	23 lb. (10 kg)
2 Drawers	20" (50,8)	8" (20,3)	2" (5,1)	
1 Drawer	20" (50,8)	8" (20,3)	2-1/2" (6,4)	

Storage Capacity: 1606 in³ (26306 cm³)



21" Two Drawer Chest WT524

21" W (53,3 cm) 8-3/4" D (22,2 cm)
9" H (22,8 cm) 16 lbs. (7,3 kg)

	Width in (cm)	Depth in (cm)	Height in (cm)	Weight
Overall	21" (53,3)	8-3/4" (22,2)	9" (22,9)	16 lb. (7,3 kg)
2 Drawers	20" (50,8)	8" (20,3)	2" (5,1)	

Storage Capacity: 1228 in³ (20115 cm³)





**21" Heavy-Duty Mechanic's Box
 with Tray
 WT520**

21" W (53,3 cm) 8-3/4" D (22,2 cm)
 9" H (22,9 cm) 10.8 lbs. (4,9 kg)

	Width in (cm)	Depth in (cm)	Height in (cm)	Weight
Overall	21" (53,3)	8-3/4" (22,2)	9" (22,9)	10.8 lb. (4,9 kg)
1 Tray	20-5/8" (52,3)	8-1/4" (20,9)	2" (5,1)	

Storage Capacity: 1613 in³ (26421 cm³)



**19" Tool Box with Tray
 WT528**

19" W (48,3 cm) 6" D (15,2 cm)
 6-1/2" H (16,5 cm) 5.4 lbs. (2,45 kg)

	Width in (cm)	Depth in (cm)	Height in (cm)	Weight
Overall	19" (48,3)	6" (15,2)	6-1/2" (16,5)	5.4 lb. (2,45 kg)
1 Tray	18-1/2" (47)	5-1/2" (13,9)	2" (5,1)	

Storage Capacity: 741 in³ (12138 cm³)





Five Drawer Road Warrior Chest WT916B (Black)

26" W (66,0) 17-7/8" D (45,4)
22" H (55,8) 124 lbs. (56,3 kg)

- Heavy-gauge metal prevents buckling and cracking.
- Drop-front cover has neoprene seal to make the unit water-resistant and dust-tight.
- Welded side handles allow easy movement.
- Powder-coat black paint provides long-lasting durability in outdoor environments.
- Full-length drawer holds long tools used on heavy-duty equipment.
- Shielded hinges.
- Cushion bars attached to tool chest bottom provide protection; keep box off the floor in wet conditions.
- Heavy-duty slides assure easy, long-term drawer movement.

	Width in(cm)	Depth in(cm)	Height in(cm)
Overall	26" (66,0)	17-7/8" (45,4)	22" (55,8)
2 Drawers	23" (58,4)	16" (40,6)	4-1/4" (10,8)
3 Drawers	23" (58,4)	16" (40,6)	2" (5,1)

Storage Capacity: 6749 in³ (110088 cm³)

Five Drawer Road Warrior Chest WT933B (Black)

34" W (86,4) 17-7/8" D (45,4)
22" H (55,8) 190 lbs. (86,3 kg)

	Width in(cm)	Depth in(cm)	Height in(cm)
Overall	34" (86,4)	17-7/8" (45,4)	22" (55,8)
2 Drawers	31" (78,7)	16" (40,6)	4-1/4" (10,8)
3 Drawers	31" (78,7)	16" (40,6)	2" (5,1)

Storage Capacity: 9028 in³ (147262 cm³)





Replacement Lock & Key Sets

Need serial number on back of box or number on lock if keyhead is square or round.

Part No.	Used For	Type
WT009	Fits tool chest WT950 (RB) & WT960 (RB) only	Tubular Lock
WT3003	Fits tool chest WT523, WT524	Flat Key Lock
WT3010	Fits tool chest WT796, WT805, WT854	Flat Key Lock
WT3012	Fits tool chest WT710 (RB), WT803, WT804	Flat Key Lock
WT3014	Fits tool chest WT895, WT899, WT814, WT896	Flat Key Lock
WT3016	Fits tool chest WT861	Flat Key Lock



Tool Boxes

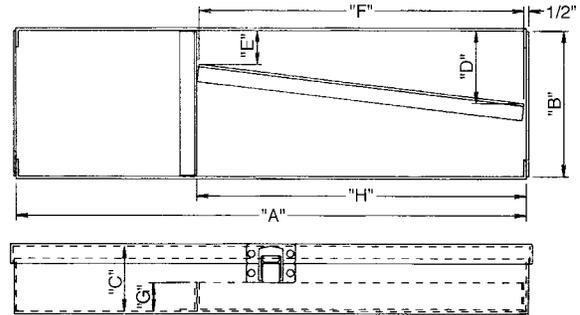

Box No.	A	B	C	D	E	F	G	H	Required Catch
11	10-3/4"	4-1/2"	1-1/8"	—	—	—	—	—	Chrome Catch
13	13"	5-1/4"	1-1/4"	—	—	—	—	—	Chrome Catch
22	13-1/2"	4-1/4"	2-9/16"	2-13/32"	2-1/8"	13"	2"	—	Chrome Catch
23	11-3/4"	4"	3-5/8"	—	—	—	—	—	Chrome Catch
45**	18-1/4"	5-1/4"	2-1/4"	—	—	—	—	—	Chrome Catch
W316	16-1/4"	3-1/2"	1-1/2"	1-1/16"	21/32"	10-5/8"	5/8"	8-3/32"	Chrome Catch
90	6-3/4"	3-3/4"	1-1/2"	13/16"	1/2"	6-3/4"	7/8"	N/A	Chrome Catch
W408	8"	3-3/4"	1-1/2"	1-1/4"	5/8"	7-15/16"	5/8"	N/A	Chrome Catch
W416	16"	3-3/4"	1-1/2"	1-1/4"	5/8"	9-7/8"	5/8"	7-15/16"	Chrome Catch
W417	17-3/4"	3-3/4"	2"	1-25/32"	13/16"	17-11/16"	1"	—	Chrome Catch
96A*	25-1/2"	5-1/4"	3"	2-3/8"	1-3/8"	24-1/2"	1-7/16"	—	Hasp-Staple Combination Latch
97	4-29/32"	2-5/16"	15/16"	—	—	—	—	—	Chrome Catch
98	20"	4"	1-1/2"	1-13/32"	21/32"	11-11/16"	5/8"	11-3/4"	Chrome Catch

*NOTE: 96A box is the only one with a 1/2" dimension and handles at each end.

**NOTE: Box accommodates speeders.

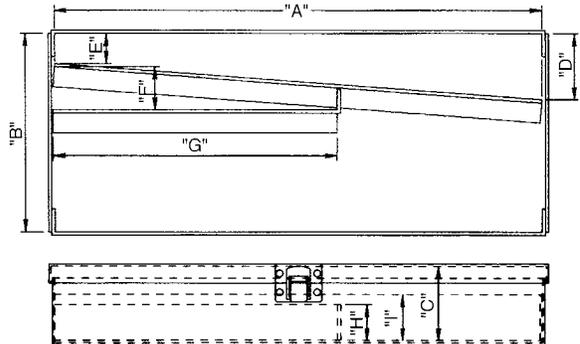

Box No.	A	B	C	D	E	F	G	H	I	Required Catch
W409	8-11/16"	3-3/4"	1-1/2"	31/32"	21/32"	1-1/16"	2-1/16"	5/8"	5/8"	Chrome Catch
88	9-1/2"	3-3/4"	1-1/2"	1-1/4"	9/16"	13/16"	5-1/2"	11/16"	7/8"	Chrome Catch
W411	10-5/8"	3-3/4"	2"	1-7/16"	13/16"	1-3/4"	4-11/16"	1"	1"	Chrome Catch
W418	18-3/8"	3-3/4"	2"	1-13/16"	7/8"	15/16"	3-13/32"	1"	1"	Chrome Catch



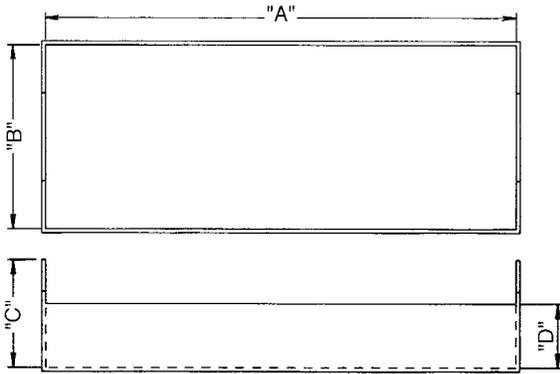

Box No.	A	B	C	D
89	14-7/8"	5-3/4"	3-3/8"	2"

Chrome catch in center of box. Handle in middle of hip roof top.

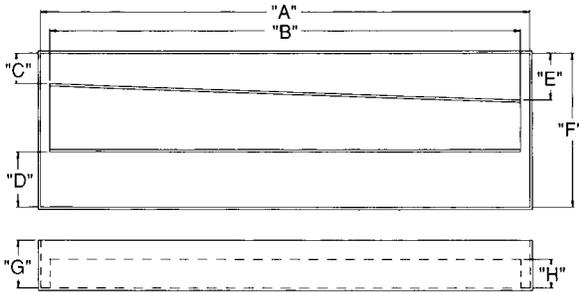

Box No.	A	B	C	D	E	F	G	H	Required Catch
237	26-1/4"	25-1/4"	1-11/16"	3"	2-9/16"	8-3/16"	3-3/8"	2"	Two Hasp-Staple Combination Latches

Note: Handle at each end.

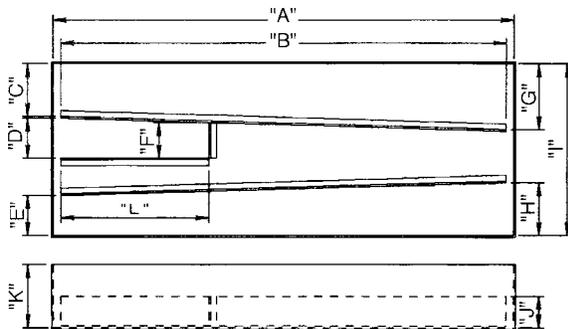

Box No.	A	B	C	D	E	F	G	H	I	J	K	L	Required Catch
299	31"	30"	3-1/2"	2-11/16"	2-11/16"	2-1/4"	4-1/2"	3-9/16"	11-1/2"	2-1/8"	4-3/8"	10"	Two Hasp-Staple Combination Latches

Note: Handle at each end.



Clip Rails, Denim Tool Rolls & Pouches



Clip Rails

SAE Red		Metric Blue	
Part No.	Size	Part No.	Size
W008	8"	W108	8"
W010	10"	W110	10"
W013	13"	W113	13"

Clips

Part No.	Size
W2	1/4"
W3	3/8"
W4	1/2"

NOTE: Clips can be used on any length rail.



Denim Tool Rolls

Denim Tool Roll No.	A Width	B Height	No. of Pockets
707-ROLL	13"	13-3/4"	7
711-ROLL	22-5/8"	17-3/4"	11
714-ROLL	30-3/4"	22-1/4"	14
715-ROLL	28-1/2"	22-1/4"	15
732-ROLL	35"	23"	18
733-ROLL	33-1/2"	19"	14
735-ROLL	11-1/8"	13-1/2"	5
736-ROLL	13-1/2"	16"	6
737-ROLL	16-3/4"	21-1/8"	7
738-ROLL	18-7/16"	21"	8
739-ROLL	21-1/4"	19-1/4"	10
740-ROLL	11-5/8"	13"	6
741-ROLL	20-7/8"	16"	10
742-ROLL	15"	10-3/4"	7
743-ROLL	7-3/8"	12-1/2"	3
744-ROLL	10-3/8"	12"	5
745-ROLL	20-1/2"	10"	9
746-ROLL	12-1/8"	20"	5
751-ROLL	18"	14-3/8"	10
752-ROLL	24"	15-3/4"	15
758-ROLL	35-1/4"	16-3/4"	18
9560-ROLL	8-1/4"	10"	5



Denim Tool Pouches

Denim back with vinyl front.

Denim Pouch No.	A Width	B Height	Used for Sets
A707-Pouch	5"	13-7/8"	A705, A707, A750 & A751
A711-Pouch	7-1/4"	17-1/4"	A711, A752, A758, 9214, 9218, 9462, 9463, 9475, 9476 & 9477
A714-Pouch	9-5/16"	21-1/2"	A714, A715 & 9464
A724-Pouch	7-1/4"	14"	723, 724, 754, 9210, 9212 & 9216





Straight Style Wrench Racks

Part No.	Description	Color
S1507RACK	7 Pieces	Red
S1510RACK	10 Pieces	Black
S1512RACK	11 Pieces	Red

Angle Style Wrench Racks

Part No.	Description	Color
S1198RACK	7 Pieces	Red
S1202RACK	11 Pieces	Red
S1203RACK	15 Pieces	Red



Straight Style



Angle Style



WRENCHES



Wright wrenches feel as good as they look. And they have a reserve of strength for tough jobs. They feature the patented Wright Drive™ and WrightGrip™, which provides more torque with less fastener damage, distributing stress evenly over a larger contact area and away from the fastener corners. They're ideal for applications ranging from standard nuts and bolts to aerospace fasteners. We also offer striking wrenches for extra-heavy-duty use.



WRENCHES.





W A R N I N G !

WRENCHES

- Users and bystanders must wear safety goggles.
- To avoid possible eye injury from flying objects, safety goggles or equivalent protection conforming to ANSI Z87.1 shall be worn and kept clean by the user and all persons in the immediate area where any tool is being used.
- Comfort or plastic grips on handles are not intended to give any degree of protection against electric shock and shall not be used on or near live electric circuits.
- Wrenches are to be used by hand only. Do not use cheater bars or any other means of increasing leverage. The only wrenches that can be struck with a hammer are striking wrenches.
- Never use wrenches for prying or as a hammer.
- Never expose any wrench to excessive heat, which may change the hardness or microstructure and ruin the tool.
- Wrenches are to be used to turn (tighten and loosen) fasteners.
- Users shall apply a controlled force with a stance adjusted and braced to prevent rapid bodily movement or a fall if sudden release occurs.
- Use the correct size wrench, do not use metric wrenches on inch fasteners or inch wrenches on metric fasteners, because the fit is not good enough.
- Always be sure to fully seat an open-end wrench on the nut or bolt.
- Adjustable wrenches need to be tightly adjusted to fit the nut with the force applied to the fixed jaw. Never use adjustable wrenches for the initial breaking loose of a “frozen” fastener or for final tightening.
- Pipe wrenches are designed to turn or hold pipe; never use a pipe wrench to bend, raise or lift a pipe. Do not use pipe wrenches on square stock.
- Inspect each pipe wrench or adjustable wrench before use for worn or broken teeth, thumbscrews or jaws and discard if deteriorated.
- Inspect and discard bent, worn or cracked wrenches.
- Wrench opening configurations shall be inspected before each use and their use discontinued at the first sign of significant wrenching surface deterioration.
- Wrenches shall not be used when jaws are sprung to the point slippage may occur.

STRIKING WRENCHES

- Users and bystanders must wear safety goggles.
- To avoid possible eye injury from flying objects, safety goggles or equivalent protection conforming to ANSI Z87.1 shall be worn and kept clean by the user and all persons in the immediate area where any tool is being used.
- Striking wrenches are special-purpose tools designed and intended only for use with heavy-duty fasteners where shock or impact is needed to fully tighten or loosen.
- A striking tool shall always be used with the striking face parallel to the struck face of the wrench. Glancing blows, overstrikes and understrikes need to be avoided. No surface of the wrench other than the struck face shall be struck. The striking tool of the appropriate size shall have a striking face diameter not less than 3/8” larger than the struck face of the wrench.
- Users shall apply a controlled force with a stance adjusted and braced to prevent rapid bodily movement or a fall if sudden release occurs.
- Striking wrenches shall not be used with “cheater” pipes or other means to extend the length of the tool.
- Striking wrenches shall be inspected prior to each use and their use discontinued at the first sign of bending of the shank or chipping or cracking of the box end or struck block. Deformation of the wrenching configuration may occur from tool usage.
- Striking wrenches shall be inspected prior to each use and their use discontinued at the first sign of significant wrenching surface deterioration.
- At the first indication of mushrooming, the struck face and struck face chamfer of the striking wrench shall be redressed to its original contour by the use of a hand file or whetstone.
- Except the struck face, no area, section, or portion of the striking wrench shall be ground, welded, treated by reheating, or otherwise altered from the original condition as furnished by the manufacturer.
- Care shall be exercised to prevent the wrench from dislodging from the fastener or nut while being impacted.

ASME B107.100 – Flat Wrenches

ASME B107.59 – Striking Wrenches



Wrenches



More Bite From WRIGHT

The new design provides 50% more strength and longer service life than traditional open-end wrenches, with no increase in the tool's outside dimensions. When compared with other high-quality wrenches, the improvement in strength is as high as 80%.

The advanced opening profile places more metal in high-stress areas to stiffen the jaws, increase tool strength and reduce permanent jaw spread for better reliability. In addition, the carefully placed, precision-broached serrations keep the wrench seated on the fastener to increase torque and reduce slippage.

WRIGHTGrip is a design evolution for open-end wrenches similar to what the Wright Drive™ was for sockets and box wrenches. The design utilizes advanced CAD/CAM technologies to improve the wrench-to-fastener contact areas. As with the Wright Drive, this increased contact improves torque load capabilities wherever WRIGHTGrip wrenches are used.

More Torque, Longer Life, Higher Strength.

WRIGHTGrip Is Now A Standard Feature

WRIGHTGrip is now offered on the open end of combination wrenches in sizes up to 1-1/4". Like all Wright tools, Wright wrenches are manufactured in the U.S.A. with a quality process that exceeds ISO 9001/2000. They are precision-manufactured from WRIGHTALLOY™ steel for added strength and durability. The new wrenches continue to feature Wright Tool's comfortable, reliable grip, as well as the brand's outstanding professional appearance.

Yet Another Wright Innovation

The improvements to the Wright line of wrenches are the result of the manufacturer's relentless pursuit of quality, innovative design, and extensive research and development. The higher torques required in many applications demand tools with higher strength and performance. Wright Tool has long been known for incorporating such advanced technologies to improve the company's entire line of tools.

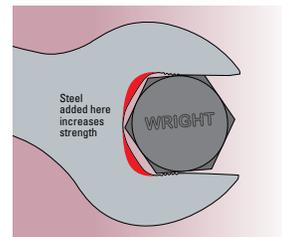
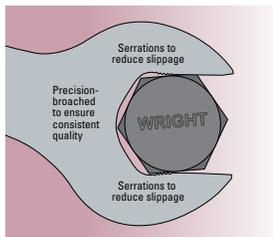



Wrenches

WRIGHTGrip

**7 Pieces – Combination
Set No. 705**

12 Pt. Combination Wrenches

Part No.	Description	Part No.	Description
1108	1/4"	1116	1/2"
1110	5/16"	1118	9/16"
1112	3/8"	1120	5/8"
1114	7/16"	707-Roll	Denim Tool Roll



WRIGHTGrip

**7 Pieces – Combination
Set No. 707**

12 Pt. Combination Wrenches

Part No.	Description	Part No.	Description
1112	3/8"	1120	5/8"
1114	7/16"	1122	11/16"
1116	1/2"	1124	3/4"
1118	9/16"	707-Roll	Denim Tool Roll



WRIGHTGrip

**11 Pieces – Combination
Set No. 711**

12 Pt. Combination Wrenches

Part No.	Description	Part No.	Description
1112	3/8"	1124	3/4"
1114	7/16"	1126	13/16"
1116	1/2"	1128	7/8"
1118	9/16"	1130	15/16"
1120	5/8"	1132	1"
1122	11/16"	711-Roll	Denim Tool Roll





WRIGHTGrip

14 Pieces – Combination Set No. 714

12 Pt. Combination Wrenches

Part No.	Description	Part No.	Description
1112	3/8"	1128	7/8"
1114	7/16"	1130	15/16"
1116	1/2"	1132	1"
1118	9/16"	1134	1-1/16"
1120	5/8"	1136	1-1/8"
1122	11/16"	1140	1-1/4"
1124	3/4"	714-Roll	Denim Tool Roll
1126	13/16"		



WRIGHTGrip

15 Pieces – Combination Set No. 715

12 Pt. Combination Wrenches

Part No.	Description	Part No.	Description
1110	5/16"	1126	13/16"
1112	3/8"	1128	7/8"
1114	7/16"	1130	15/16"
1116	1/2"	1132	1"
1118	9/16"	1134	1-1/16"
1120	5/8"	1136	1-1/8"
1122	11/16"	1140	1-1/4"
1124	3/4"	715-Roll	Denim Tool Roll

WrightGrip Patent #7,340,982



Wrenches





WRIGHTGrip

**26 Pieces – Combination
Set No. 726**

12 Pt. Combination Wrenches

Part No.	Description	Part No.	Description
1108	1/4"	1136	1-1/8"
1110	5/16"	1140	1-1/4"
1112	3/8"	1142	1-5/16"
1114	7/16"	1144	1-3/8"
1116	1/2"	1146	1-7/16"
1118	9/16"	1148	1-1/2"
1120	5/8"	1152	1-5/8"
1122	11/16"	1154	1-11/16"
1124	3/4"	1156	1-3/4"
1126	13/16"	1158	1-13/16"
1128	7/8"	1160	1-7/8"
1130	15/16"	1164	2"
1132	1"	Cardboard Box	
1134	1-1/16"		



**16 Pieces – Combination
Set No. 730**

12 Pt. Combination Wrenches

Part No.	Description	Part No.	Description
1142	1-5/16"	1164	2"
1144	1-3/8"	1166	2-1/16"
1146	1-7/16"	1168	2-1/8"
1148	1-1/2"	1170	2-3/16"
1152	1-5/8"	1172	2-1/4"
1154	1-11/16"	1176	2-3/8"
1156	1-3/4"	1180	2-1/2"
1158	1-13/16"	Cardboard Box	
1160	1-7/8"		



Wrenches





11 Pieces – Combination Set No. 750

12 Pt. Metric Combination Wrenches

Part No. Description

11-07mm	7mm	11-13mm	13mm
11-08mm	8mm	11-14mm	14mm
11-09mm	9mm	11-15mm	15mm
11-10mm	10mm	11-17mm	17mm
11-11mm	11mm	11-19mm	19mm
11-12mm	12mm	711-Roll	Denim Tool Roll



10 Pieces – Combination Set No. 751

12 Pt. Metric Combination Wrenches

Part No. Description Part No. Description

11-10mm	10mm	11-16mm	16mm
11-11mm	11mm	11-17mm	17mm
11-12mm	12mm	11-18mm	18mm
11-13mm	13mm	11-19mm	19mm
11-14mm	14mm	751-Roll	Denim Tool Roll
11-15mm	15mm		





**15 Pieces – Combination
 Set No. 752**

12 Pt. Metric Combination Wrenches

Part No.	Description	Part No.	Description
11-07mm	7mm	11-15mm	15mm
11-08mm	8mm	11-16mm	16mm
11-09mm	9mm	11-17mm	17mm
11-10mm	10mm	11-18mm	18mm
11-11mm	11mm	11-19mm	19mm
11-12mm	12mm	11-21mm	21mm
11-13mm	13mm	11-22mm	22mm
11-14mm	14mm	752-Roll	Denim Tool Roll



**18 Pieces – Combination
 Set No. 758**

12 Pt. Metric Combination Wrenches

Part No.	Description	Part No.	Description
11-07mm	7mm	11-17mm	17mm
11-08mm	8mm	11-18mm	18mm
11-09mm	9mm	11-19mm	19mm
11-10mm	10mm	11-20mm	20mm
11-11mm	11mm	11-21mm	21mm
11-12mm	12mm	11-22mm	22mm
11-13mm	13mm	11-23mm	23mm
11-14mm	14mm	11-24mm	24mm
11-15mm	15mm	758-Roll	Denim Tool Roll
11-16mm	16mm		



Wrenches





28 Pieces – Combination Set No. 760

12 Pt. Metric Combination Wrenches

Part No.	Description	Part No.	Description
11-06mm	6mm	11-21mm	21mm
11-07mm	7mm	11-22mm	22mm
11-08mm	8mm	11-23mm	23mm
11-09mm	9mm	11-24mm	24mm
11-10mm	10mm	11-25mm	25mm
11-11mm	11mm	11-26mm	26mm
11-12mm	12mm	11-27mm	27mm
11-13mm	13mm	11-30mm	30mm
11-14mm	14mm	11-32mm	32mm
11-15mm	15mm	11-36mm	36mm
11-16mm	16mm	11-41mm	41mm
11-17mm	17mm	11-46mm	46mm
11-18mm	18mm	11-50mm	50mm
11-19mm	19mm	Cardboard Box	
11-20mm	20mm		



WRIGHTGrip

7 Pieces – Combination Wrench Set No. 720

Black 12 Pt. Combination Wrenches

Part No.	Description	Part No.	Description
31112	3/8"	31120	5/8"
31114	7/16"	31122	11/16"
31116	1/2"	31124	3/4"
31118	9/16"	707-Roll	Denim Tool Roll



WRIGHTGrip

14 Pieces – Combination Wrench Set No. 721

Black 12 Pt. Combination Wrenches

Part No.	Description	Part No.	Description
31112	3/8"	31128	7/8"
31114	7/16"	31130	15/16"
31116	1/2"	31132	1"
31118	9/16"	31134	1-1/16"
31120	5/8"	31136	1-1/8"
31122	11/16"	31140	1-1/4"
31124	3/4"	714-Roll	Denim Tool Roll
31126	13/16"		





WRIGHTGrip

7 Pieces – Full Polish Combination Set No. 905

12 Pt. Full Polish Combination Wrenches

Part No.	Description	Part No.	Description
1208	1/4"	1216	1/2"
1210	5/16"	1218	9/16"
1212	3/8"	1220	5/8"
1214	7/16"	707-Roll	Denim Tool Roll



WRIGHTGrip

7 Pieces – Full Polish Combination Set No. 907

12 Pt. Full Polish Combination Wrenches

Part No.	Description	Part No.	Description
1212	3/8"	1220	5/8"
1214	7/16"	1222	11/16"
1216	1/2"	1224	3/4"
1218	9/16"	707-Roll	Denim Tool Roll



WRIGHTGrip

11 Pieces – Full Polish Combination Set No. 911

12 Pt. Full Polish Combination Wrenches

Part No.	Description	Part No.	Description
1212	3/8"	1224	3/4"
1214	7/16"	1226	13/16"
1216	1/2"	1228	7/8"
1218	9/16"	1230	15/16"
1220	5/8"	1232	1"
1222	11/16"	711-Roll	Denim Tool Roll





WRIGHTGrip

14 Pieces – Full Polish Combination Set No. 914

12 Pt. Full Polish Combination Wrenches

Part No.	Description	Part No.	Description
1212	3/8"	1228	7/8"
1214	7/16"	1230	15/16"
1216	1/2"	1232	1"
1218	9/16"	1234	1-1/16"
1220	5/8"	1236	1-1/8"
1222	11/16"	1240	1-1/4"
1224	3/4"	714-Roll	Denim Tool Roll
1226	13/16"		



WRIGHTGrip

15 Pieces – Full Polish Combination Set No. 915

12 Pt. Full Polish Combination Wrenches

Part No.	Description	Part No.	Description
1210	5/16"	1226	13/16"
1212	3/8"	1228	7/8"
1214	7/16"	1230	15/16"
1216	1/2"	1232	1"
1218	9/16"	1234	1-1/16"
1220	5/8"	1236	1-1/8"
1222	11/16"	1240	1-1/4"
1224	3/4"	715-Roll	Denim Tool Roll



11 Pieces – Full Polish Combination Set No. 950

12 Pt. Metric Full Polish Combination Wrenches

Part No.	Description	Part No.	Description
12-07mm	7mm	12-13mm	13mm
12-08mm	8mm	12-14mm	14mm
12-09mm	9mm	12-15mm	15mm
12-10mm	10mm	12-17mm	17mm
12-11mm	11mm	12-19mm	19mm
12-12mm	12mm	711-Roll	Denim Tool Roll



Wrenches





15 Pieces – Full Polish Combination Set No. 952

12 Pt. Metric Full Polish Combination Wrenches

Part No.	Description	Part No.	Description
12-07mm	7mm	12-15mm	15mm
12-08mm	8mm	12-16mm	16mm
12-09mm	9mm	12-17mm	17mm
12-10mm	10mm	12-18mm	18mm
12-11mm	11mm	12-19mm	19mm
12-12mm	12mm	12-21mm	21mm
12-13mm	13mm	12-22mm	22mm
12-14mm	14mm	752-Roll	Denim Tool Roll



18 Pieces – Full Polish Combination Set No. 958

12 Pt. Metric Full Polish Combination Wrenches

Part No.	Description	Part No.	Description
12-07mm	7mm	12-17mm	17mm
12-08mm	8mm	12-18mm	18mm
12-09mm	9mm	12-19mm	19mm
12-10mm	10mm	12-20mm	20mm
12-11mm	11mm	12-21mm	21mm
12-12mm	12mm	12-22mm	22mm
12-13mm	13mm	12-23mm	23mm
12-14mm	14mm	12-24mm	24mm
12-15mm	15mm	758-Roll	Denim Tool Roll
12-16mm	16mm		



5 Pieces – Full Polish Open-End Set No. 735

Open-End Wrenches

Part No.	Description	Part No.	Description
1314	3/8" x 7/16"	1325	11/16" x 3/4"
1318	1/2" x 9/16"	1329	13/16" x 7/8"
1320	9/16" x 5/8"	735-Roll	Denim Tool Roll



Wrenches





6 Pieces – Full Polish Open-End Set No. 736

Open-End Wrenches

Part No.	Description	Part No.	Description
1310	1/4" x 5/16"	1326	3/4" x 13/16"
1314	3/8" x 7/16"	1330	7/8" x 15/16"
1318	1/2" x 9/16"	736-Roll	Denim Tool Roll
1322	5/8" x 11/16"		



8 Pieces – Full Polish Open-End Set No. 738

Open-End Wrenches

Part No.	Description	Part No.	Description
1310	1/4" x 5/16"	1330	7/8" x 15/16"
1314	3/8" x 7/16"	1332	15/16" x 1"
1318	1/2" x 9/16"	1340	1-1/8" x 1-1/4"
1322	5/8" x 11/16"	738-Roll	Denim Tool Roll
1326	3/4" x 13/16"		



10 Pieces – Full Polish Open-End Set No. 739

Open-End Wrenches

Part No.	Description	Part No.	Description
1310	1/4" x 5/16"	1325	11/16" x 3/4"
1312	5/16" x 3/8"	1329	13/16" x 7/8"
1316	7/16" x 1/2"	1332	15/16" x 1"
1318	1/2" x 9/16"	1336	1-1/16" x 1-1/8"
1320	9/16" x 5/8"	739-Roll	Denim Tool Roll
1324	5/8" x 3/4"		





**6 Pieces – Full Polish Open-End
Set No. 740**

Metric Open-End Wrenches

Part No.	Description	Part No.	Description
13-0809mm	8 x 9mm	13-1617mm	16 x 17mm
13-1011mm	10 x 11mm	13-1819mm	18 x 19mm
13-1213mm	12 x 13mm	740-Roll	Denim Tool Roll
13-1415mm	14 x 15mm		



**10 Pieces – Full Polish Open-End
Set No. 741**

Metric Open-End Wrenches

Part No.	Description	Part No.	Description
13-0607mm	6 x 7mm	13-1819mm	18 x 19mm
13-0809mm	8 x 9mm	13-2022mm	20 x 22mm
13-1011mm	10 x 11mm	13-2123mm	21 x 23mm
13-1213mm	12 x 13mm	13-2426mm	24 x 26mm
13-1415mm	14 x 15mm	741-Roll	Denim Tool Roll
13-1617mm	16 x 17mm		



**18 Pieces – 15° & 60° Angle Wrench
Set No. 732**

15° & 60° Angle Wrench Set

Part No.	Description	Part No.	Description
1361	11/32" x 11/32"	1380	15/16" x 15/16"
1362	3/8" x 3/8"	1382	1" x 1"
1364	7/16" x 7/16"	1383	1-1/16" x 1-1/16"
1366	1/2" x 1/2"	1384	1-1/8" x 1-1/8"
1368	9/16" x 9/16"	1386	1-1/4" x 1-1/4"
1370	5/8" x 5/8"	1388	1-3/8" x 1-3/8"
1372	11/16" x 11/16"	1389	1-7/16" x 1-7/16"
1374	3/4" x 3/4"	1390	1-1/2" x 1-1/2"
1376	13/16" x 13/16"	732-Roll	Denim Tool Roll
1378	7/8" x 7/8"		



Wrenches





14 Pieces – 15° & 60° Angle Wrench Set No. 733

15° & 60° Angle Wrench Set

Part No.	Description	Part No.	Description
1362	3/8" x 3/8"	1378	7/8" x 7/8"
1364	7/16" x 7/16"	1380	15/16" x 15/16"
1366	1/2" x 1/2"	1382	1" x 1"
1368	9/16" x 9/16"	1383	1-1/16" x 1-1/16"
1370	5/8" x 5/8"	1384	1-1/8" x 1-1/8"
1372	11/16" x 11/16"	1386	1-1/4" x 1-1/4"
1374	3/4" x 3/4"	733-Roll	Denim Tool Roll
1376	13/16" x 13/16"		



7 Pieces – 15° & 60° Angle Wrench Set No. 734

15° & 60° Angle Wrench Set

Part No.	Description
1362	3/8" x 3/8"
1364	7/16" x 7/16"
1366	1/2" x 1/2"
1368	9/16" x 9/16"
1370	5/8" x 5/8"
1372	11/16" x 11/16"
1374	3/4" x 3/4"
707-Roll	Denim Tool Roll



10 Pieces – Combination Set No. 787

Miniature Combination Wrench Set

Part No.	Description
Set No. 787	5/32" 1/4"
	3/16" 9/32"
	13/64" 5/16"
	7/32" 3/8"
	15/64" 7/16"

Supplied in Plastic Pouch

Sold in sets only. No individual wrenches available.





10 Pieces – Metric Miniature Combination Wrench Set No. 788

Metric Miniature Combination Wrench Set

Part No.	Description
Set No. 788	6 Pt. Midget Combo Wrench 4mm
	6 Pt. Midget Combo Wrench 4.5mm
	12 Pt. Midget Combo Wrench 5mm
	12 Pt. Midget Combo Wrench 5.5mm
	12 Pt. Midget Combo Wrench 6mm
	12 Pt. Midget Combo Wrench 7mm
	12 Pt. Midget Combo Wrench 8mm
	12 Pt. Midget Combo Wrench 9mm
	12 Pt. Midget Combo Wrench 10mm
	12 Pt. Midget Combo Wrench 11mm

Supplied in Plastic Pouch
Sold in sets only. No individual wrenches available.



7 Pieces – Metric Miniature Open-End Wrench Set No. 799

Metric Miniature Open-End Wrench Set

Part No.	Description
Set No. 799	Midget Open-End Wrench 5.5mm
	Midget Open-End Wrench 6mm
	Midget Open-End Wrench 7mm
	Midget Open-End Wrench 8mm
	Midget Open-End Wrench 9mm
	Midget Open-End Wrench 10mm
	Midget Open-End Wrench 11mm

Supplied in Plastic Pouch
Sold in sets only. No individual wrenches available.



8 Pieces – Miniature Open-End Wrench Set No. 798

Miniature Open-End Wrench Set

Part No.	Description
Set No. 798	Miniature Open-End Wrench Set
	7/32" x 7/32" 5/16" x 5/16"
	15/64" x 15/64" 11/32" x 11/32"
	1/4" x 1/4" 3/8" x 3/8"
	9/32" x 9/32" 7/16" x 7/16"

Supplied in Plastic Pouch
Sold in sets only. No individual wrenches available.





3 Pieces – ⑥ Pt. Flare Nut Set No. 743

Flare Nut Wrenches

Part No.	Description	Part No.	Description
1614	3/8" x 7/16"	1622	5/8" x 11/16"
1618	1/2" x 9/16"	743-Roll	Denim Tool Roll



5 Pieces – ⑥ Pt. Flare Nut Set No. 744

Metric Flare Nut Wrenches

Part No.	Description	Part No.	Description
16-11mm	9mm x 11mm	16-17mm	15mm x 17mm
16-12mm	10mm x 12mm	16-21mm	19mm x 21mm
16-14mm	13mm x 14mm	744-Roll	Denim Tool Roll



7 Pieces – Combination Open-End & ⑥ Pt. Flare Nut Wrenches Set No. 742

Open-End Flare Nut Wrenches

Part No.	Description	Part No.	Description
1040	3/8"	1048	5/8"
1042	7/16"	1050	11/16"
1044	1/2"	1052	3/4"
1046	9/16"	742-Roll	Denim Tool Roll





9 Pieces – Service Wrench Set No. 745

Service Wrenches – 30° Angle, Satin Finish

Part No.	Description	Part No.	Description
1424	3/4"	1434	1-1/16"
1426	13/16"	1436	1-1/8"
1428	7/8"	1438	1-3/16"
1430	15/16"	1440	1-1/4"
1432	1"	745-Roll	Denim Tool Roll



5 Pieces – Satin Finish Box Wrench Set No. 747

12 Pt. Box Wrenches – Modified Offset

Part No.	Description	Part No.	Description
51012	5/16" x 3/8"	52224	11/16" x 3/4"
51416	7/16" x 1/2"	52628	13/16" x 7/8"
51820	9/16" x 5/8"	747-Roll	Denim Tool Roll



7 Pieces – Satin Finish Box Wrench Set No. 749

12 Pt. Box Wrenches – Modified Offset

Part No.	Description	Part No.	Description
51012	5/16" x 3/8"	52628	13/16" x 7/8"
51416	7/16" x 1/2"	53032	15/16" x 1"
51820	9/16" x 5/8"	53436	1-1/16" x 1-1/8"
52224	11/16" x 3/4"	737-Roll	Denim Tool Roll



Wrenches





5 Pieces – 12 Pt. Ratcheting Box Wrench - Offset Pattern
Set No. 9429

Ratcheting Box Wrenches

Part No.	Description	Part No.	Description
9424	1/4" x 5/16"	9427	5/8" x 11/16"
9425	3/8" x 7/16"	9428	3/4" x 7/8"
9426	1/2" x 9/16"	735-Roll	Denim Tool Roll



5 Pieces – 12 Pt. Ratcheting Box Wrench - Straight Pattern
Set No. 9430

Metric Ratcheting Box Wrenches

Part No.	Description	Part No.	Description
9416	7 x 8 mm	9421	15 x 17 mm
9417	9 x 10 mm	735-Roll	Denim Tool Roll
9418	11 x 12 mm		
9419	13 x 14 mm		



5 Pieces – 12 Pt. Ratcheting Box Wrench - Straight Pattern
Set No. 9439

Ratcheting Box Wrenches

Part No.	Description	Part No.	Description
9381	1/4" x 5/16"	9386	3/4" x 7/8"
9382	3/8" x 7/16"	735-Roll	Denim Tool Roll
9383	1/2" x 9/16"		
9384	5/8" x 11/16"		





7 Pieces – 12 Pt. Ratcheting Box Wrench - Offset Pattern Set No. 9446

Metric Ratcheting Box Wrenches

Part No.	Description	Part No.	Description
9431	7mm x 8mm	9436	15mm x 17mm
9432	9mm x 10mm	9437	16mm x 18mm
9434	11mm x 12mm	9438	19mm x 21mm
9435	13mm x 14mm	707-Roll	Denim Tool Roll



7 Pieces – Ratcheting Flare Nut Wrench Set No. 1640

Part No.	Description	Part No.	Description
1642	3/8"	1650	5/8"
1644	7/16"	1652	11/16"
1646	1/2"	1654	3/4"
1648	9/16"	Vinyl Tool Roll	



4 Pieces – Spanner Wrench Set No. 9629

Spanner Wrenches - Black

Part No.	Description
9630	3/4 to 2", 1/8" Hook
9631	1-1/4 to 3", 5/32" Hook
9632	2 to 4-3/4", 3/16" Hook
9633	4-1/2 to 6-1/4", 5/16" Hook
Cardboard Box	



Wrenches





Wrench Sets

Most wrench sets are available in a pouch. Call your Wright Tool representative for further information.





Combination Wrenches – Satin Finish

12 Pt. Flat Stem

Part No.	A Nom. Size	L	C	B	D	E
1108	1/4"	4-59/64"	35/64"	5/16"	11/64"	13/64"
1110	5/16"	5-1/2"	43/64"	3/8"	3/16"	15/64"
1112	3/8"	6"	51/64"	29/64"	7/32"	17/64"
1114	7/16"	6-1/2"	15/16"	17/32"	1/4"	19/64"
1116	1/2"	7-5/32"	1-1/16"	19/32"	17/64"	11/32"
1118	9/16"	7-15/16"	1-11/64"	11/16"	19/64"	23/64"
1120	5/8"	8-35/64"	1-19/64"	3/4"	5/16"	13/32"
1122	11/16"	9-1/8"	1-27/64"	53/64"	11/32"	7/16"
1124	3/4"	10-3/64"	1-35/64"	29/32"	23/64"	15/32"
1126	13/16"	10-53/64"	1-43/64"	63/64"	27/64"	1/2"
1128	7/8"	11-3/4"	1-51/64"	61/64"	7/16"	33/64"
1130	15/16"	12-9/16"	1-29/32"	31/32"	15/32"	17/32"
1132	1"	13-5/16"	2-1/32"	1-13/64"	15/32"	5/8"
1134	1-1/16"	14-1/4"	2-5/32"	1-19/64"	31/64"	21/32"
1136	1-1/8"	15-1/8"	2-17/64"	1-23/64"	35/64"	11/16"
1138	1-3/16"	15-15/16"	2-25/64"	1-7/16"	9/16"	23/32"
1140	1-1/4"	16-13/16"	2-1/2"	1-33/64"	19/32"	3/4"

Meets or exceeds ASME B107.100



WRIGHTGrip

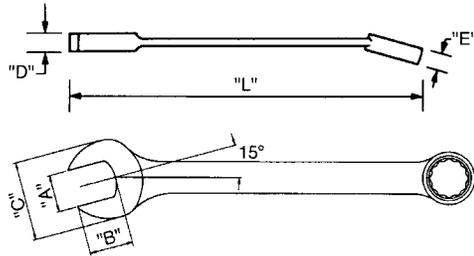

Flat Stem

Combination Wrenches – Satin Finish

12 Pt. Heavy-Duty Flat Stem

Part No.	A Nom. Size	L	C	B	D	E	F	G
1142	1-5/16"	19"	2-11/16"	1-15/32"	23/32"	7/8"	1"	3/4"
1144	1-3/8"	20"	2-11/16"	1-17/32"	23/32"	7/8"	1"	3/4"
1146	1-7/16"	21"	3"	1-19/32"	3/4"	15/16"	1-1/16"	7/8"
1148	1-1/2"	22"	3"	1-21/32"	3/4"	15/16"	1-1/16"	7/8"
1150	1-9/16"	23"	3-1/2"	1-15/16"	3/4"	15/16"	1-1/8"	7/8"
1152	1-5/8"	23"	3-1/2"	1-15/16"	3/4"	15/16"	1-1/8"	7/8"
1154	1-11/16"	23"	3-1/2"	1-15/16"	3/4"	15/16"	1-1/8"	7/8"
1156	1-3/4"	25-1/2"	3-3/4"	2-1/16"	13/16"	1"	1-1/4"	1"
1158	1-13/16"	25-1/2"	3-3/4"	2-3/32"	13/16"	1"	1-1/4"	1"
1160	1-7/8"	28"	4-1/16"	2-3/16"	7/8"	1-1/16"	1-1/4"	1"
1164	2"	28"	4-1/16"	2-5/16"	7/8"	1-1/16"	1-1/4"	1"
1166	2-1/16"	28-1/4"	4-1/4"	2-11/16"	59/64"	1-7/32"	1-1/4"	1"
1168	2-1/8"	28-1/2"	4-1/4"	2-25/64"	59/64"	1-7/32"	1-1/4"	1"
1170	2-3/16"	28-3/4"	4-1/4"	2-27/64"	59/64"	1-7/32"	1-1/4"	1"
1172	2-1/4"	29"	4-1/4"	2-29/64"	59/64"	1-7/32"	1-1/4"	1"
1176	2-3/8"	29-1/4"	4-1/2"	2-15/32"	1"	1-9/16"	1-3/8"	1-1/8"
1180	2-1/2"	29-1/2"	4-1/2"	2-1/2"	1"	1-9/16"	1-3/8"	1-1/8"
1182	2-9/16"	29-3/4"	4-1/2"	2-1/2"	1"	1-9/16"	1-3/8"	1-1/8"
1184	2-5/8"	29-3/4"	4-3/4"	2-5/8"	1-1/32"	1-5/8"	1-3/8"	1-1/8"
1188	2-3/4"	29-3/4"	4-3/4"	2-3/4"	1-1/32"	1-5/8"	1-3/8"	1-1/8"

Meets or exceeds ASME B107.100

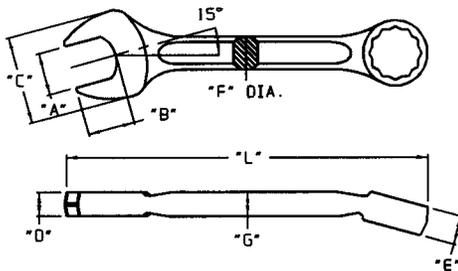

Wrenches



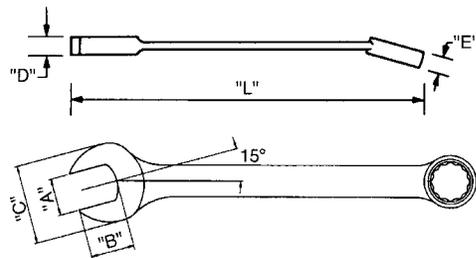
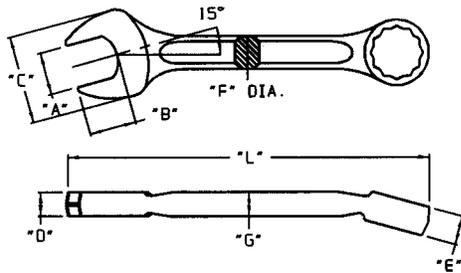

Combination Wrenches – Black Industrial Finish

12 Pt. Heavy-Duty Flat Stem

Part No.	A	L	C	B	D	E	F	G
1190	2-13/16"	33"	5-1/2"	3"	1-1/8"	1-11/16"	1-5/16"	1"
1192	2-7/8"	33-1/2"	5-1/2"	3"	1-3/16"	1-11/16"	1-5/16"	1"
1194	2-15/16"	34"	5-1/2"	3"	1-3/16"	1-11/16"	1-5/16"	1"
1196	3"	34-1/2"	5-1/2"	3"	1-3/16"	1-11/16"	1-5/16"	1"
1198	3-1/16"	35"	5-1/2"	3"	1-3/16"	1-11/16"	1-5/16"	1"
11X00	3-1/8"	35-1/2"	5-1/2"	3"	1-3/16"	1-11/16"	1-5/16"	1"
11X04	3-1/4"	36"	7"	4"	1-1/2"	2-1/4"	1-1/2"	1-1/8"
11X08	3-3/8"	36-1/2"	7"	4"	1-1/2"	2-1/4"	1-1/2"	1-1/8"
11X12	3-1/2"	37"	7"	3-7/8"	1-1/2"	2-1/4"	1-1/2"	1-1/8"
11X16	3-5/8"	37-1/2"	7"	3-7/8"	1-1/2"	2-1/4"	1-1/2"	1-1/8"
11X20	3-3/4"	38"	7"	3-13/16"	1-1/2"	2-1/4"	1-1/2"	1-1/8"
11X24	3-7/8"	38-1/2"	7"	3-13/16"	1-1/2"	2-1/4"	1-1/2"	1-1/8"
11X28	4"	39"	7"	3-13/16"	1-1/2"	2-1/4"	1-1/2"	1-1/8"

Meets or exceeds ASME B107.100

Metric Combination Wrenches

12 Pt. Flat Stem

Part No.	A	L	C	B	D	E
11-06mm	6mm	124.66	14.22	7.65	4.32	4.80
11-07mm	7mm	132.26	15.39	8.51	4.67	5.31
11-08mm	8mm	139.37	17.32	9.65	4.90	5.79
11-09mm	9mm	147.40	19.38	9.88	5.33	6.43
11-10mm	10mm	155.85	21.46	11.13	5.77	7.06
11-11mm	11mm	165.13	23.47	13.46	6.20	7.70
11-12mm	12mm	173.86	25.20	12.98	6.48	7.87
11-13mm	13mm	181.76	26.92	15.75	6.73	8.51
11-14mm	14mm	201.80	29.82	17.02	7.26	8.99
11-15mm	15mm	209.25	31.42	17.02	7.82	9.63
11-16mm	16mm	216.92	33.02	19.05	8.13	10.26
11-17mm	17mm	231.78	36.07	20.57	8.59	11.18
11-18mm	18mm	242.57	37.52	21.84	8.89	11.43
11-19mm	19mm	255.24	39.12	22.86	9.17	11.68
11-20mm	20mm	275.13	42.29	24.13	10.59	12.57
11-21mm	21mm	286.97	43.92	23.42	10.92	12.93
11-22mm	22mm	298.09	45.52	24.08	11.23	13.26
11-23mm	23mm	308.81	46.94	24.38	11.58	13.39
11-24mm	24mm	319.13	48.34	24.64	11.94	13.49
11-25mm	25mm	338.12	51.41	30.23	11.99	15.85
11-26mm	26mm	350.52	52.86	31.50	13.11	16.00
11-27mm	27mm	363.58	54.36	32.77	12.07	16.51
11-28mm	28mm	384.18	57.40	33.78	13.72	17.40
11-29mm	29mm	384.18	57.40	35.05	13.72	17.40
11-30mm	30mm	404.83	60.58	36.32	14.35	18.03
11-32mm	32mm	423.88	63.63	38.61	14.99	18.80

Meets or exceeds ASME B107.100

www.wrighttool.com





Metric Combination Wrenches

12 Pt. Heavy-Duty Flat Stem

Part No.	A Nom. Size	L	C	B	D	E	F	G
11-36mm	36mm	533.40	76.20	31.75	18.92	23.61	27.00	20.64
11-41mm	41mm	584.20	88.90	48.42	19.05	23.61	28.58	20.64
11-46mm	46mm	647.70	95.25	53.58	20.64	25.40	31.75	25.40
11-50mm	50mm	723.90	103.19	58.74	22.23	26.99	31.75	25.40
11-55mm	55mm	730.25	114	59	25	40	32	25
11-60mm	60mm	730.25	114	62	25	40	35	29
11-65mm	65mm	755.65	140	60	29	43	35	29
11-70mm	70mm	755.65	140	65	29	43	35	29
*11-75mm	75mm	964	140	76	29	43	33	29
*11-80mm	80mm	902	140	76	29	43	38	29

*Black Industrial Finish
Meets or exceeds ASME B107.100

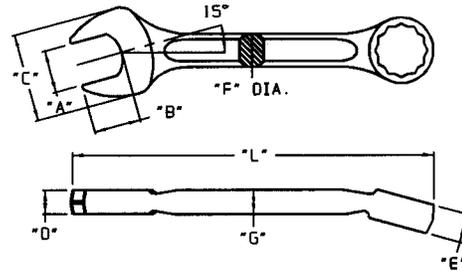

Full Polish Combination Wrenches – 12 Pt.

Part No.	A Nom. Size	L	C	B	D	E
1208	1/4"	4-59/64"	35/64"	5/16"	11/64"	13/64"
1210	5/16"	5-1/2"	43/64"	3/8"	3/16"	15/64"
1212	3/8"	6"	51/64"	29/64"	7/32"	17/64"
1214	7/16"	6-1/2"	15/16"	17/32"	1/4"	19/64"
1216	1/2"	7-5/32"	1-1/16"	19/32"	17/64"	11/32"
1218	9/16"	7-15/16"	1-11/64"	11/16"	19/64"	23/64"
1220	5/8"	8-35/64"	1-19/64"	3/4"	5/16"	13/32"
1222	11/16"	9-1/8"	1-27/64"	53/64"	11/32"	7/16"
1224	3/4"	10-3/64"	1-35/64"	29/32"	23/64"	15/32"
1226	13/16"	10-53/64"	1-43/64"	63/64"	27/64"	1/2"
1228	7/8"	11-3/4"	1-51/64"	61/64"	7/16"	33/64"
1230	15/16"	12-9/16"	1-29/32"	31/32"	15/32"	17/32"
1232	1"	13-5/16"	2-1/32"	1-13/64"	15/32"	5/8"
1234	1-1/16"	14-1/4"	2-5/32"	1-19/64"	31/64"	21/32"
1236	1-1/8"	15-1/8"	2-17/64"	1-23/64"	35/64"	11/16"
1238	1-3/16"	15-15/16"	2-25/64"	1-7/16"	17/32"	23/32"
1240	1-1/4"	16-13/16"	2-1/2"	1-33/64"	19/32"	3/4"

Meets or exceeds ASME B107.100



WRIGHTGrip

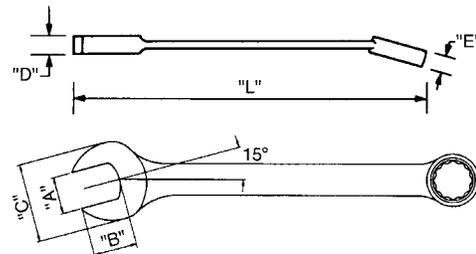

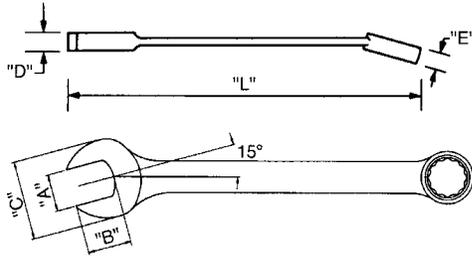

Metric Full Polish Combination Wrenches – 12 Pt.

Part No.	A Nom. Size	L	C	B	D	E
12-06mm	6mm	124.66	14.22	7.65	4.32	4.80
12-07mm	7mm	132.26	15.39	8.51	4.67	5.31
12-08mm	8mm	139.37	17.32	9.65	4.90	5.79
12-09mm	9mm	147.40	19.38	9.88	5.33	6.43
12-10mm	10mm	155.85	21.46	11.13	5.77	7.06
12-11mm	11mm	165.13	23.47	13.42	6.20	7.70
12-12mm	12mm	173.86	25.20	12.98	6.48	7.87
12-13mm	13mm	181.76	26.92	15.75	6.73	8.51
12-14mm	14mm	201.80	29.82	17.02	7.26	8.99
12-15mm	15mm	209.25	31.42	17.02	7.82	9.63
12-16mm	16mm	216.92	33.02	19.05	8.13	10.26
12-17mm	17mm	231.78	36.07	20.57	8.59	11.18
12-18mm	18mm	242.57	37.52	21.84	8.89	11.43
12-19mm	19mm	255.24	39.12	21.86	9.17	11.68
12-20mm	20mm	275.13	42.29	24.13	10.59	12.57
12-21mm	21mm	286.97	43.92	23.42	10.92	12.93
12-22mm	22mm	298.09	45.52	24.08	11.23	13.26
12-23mm	23mm	308.81	46.94	24.38	11.58	13.39
12-24mm	24mm	319.13	48.34	24.64	11.94	13.49
12-25mm	25mm	338.12	51.41	30.23	11.99	15.85
12-26mm	26mm	350.52	52.86	31.50	13.11	16.00
12-27mm	27mm	363.58	54.36	32.77	12.07	16.51
12-30mm	30mm	404.83	60.58	36.32	14.35	18.03
12-32mm	32mm	423.88	63.63	38.61	14.99	18.80

Meets or exceeds ASME B107.100

Combination Wrenches – 12 Pt.

Black Industrial Finish

Part No.	A Nom. Size	L	C	B	D	E
31108	1/4"	4-59/64"	35/64"	5/16"	11/64"	13/64"
31110	5/16"	5-1/2"	43/64"	3/8"	3/16"	15/64"
31112	3/8"	6"	51/64"	29/64"	7/32"	17/64"
31114	7/16"	6-1/2"	15/16"	17/32"	1/4"	19/64"
31116	1/2"	7-5/32"	1-1/16"	19/32"	17/64"	11/32"
31118	9/16"	7-15/16"	1-11/64"	11/16"	19/64"	23/64"
31120	5/8"	8-35/64"	1-19/64"	3/4"	5/16"	13/32"
31122	11/16"	9-1/8"	1-27/64"	53/64"	11/32"	7/16"
31124	3/4"	10-3/64"	1-35/64"	29/32"	23/64"	15/32"
31126	13/16"	10-53/64"	1-43/64"	63/64"	27/64"	1/2"
31128	7/8"	11-3/4"	1-51/64"	61/64"	7/16"	33/64"
31130	15/16"	12-9/16"	1-29/32"	31/32"	15/32"	17/32"
31132	1"	13-5/16"	2-1/32"	1-13/64"	15/32"	5/8"
31134	1-1/16"	14-1/4"	2-5/32"	1-19/64"	31/64"	21/32"
31136	1-1/8"	15-1/8"	2-17/64"	1-23/64"	35/64"	11/16"
31138	1-3/16"	15-15/16"	2-25/64"	1-7/16"	17/32"	23/32"
31140	1-1/4"	16-13/16"	2-1/2"	1-33/64"	19/32"	3/4"

Meets or exceeds ASME B107.100

www.wrighttool.com



WRIGHTGrip

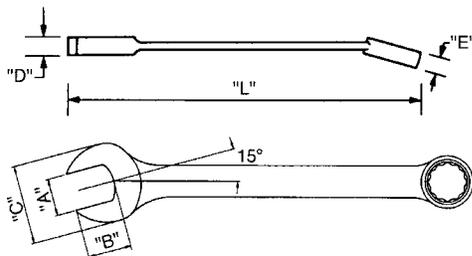



Combination Wrenches – 12 Pt. Heavy-Duty Flat Stem

Black Industrial Finish



Part No.	A Nom. Size	L	C	B	D	E	F	G
31142	1-5/16"	19"	2-11/16"	1-15/32"	23/32"	7/8"	1"	
31144	1-3/8"	20"	2-11/16"	1-17/32"	23/32"	7/8"	1"	
31146	1-7/16"	21"	3"	1-19/32"	3/4"	15/16"	1-1/16"	
31148	1-1/2"	22"	3"	1-21/32"	3/4"	15/16"	1-1/16"	
31152	1-5/8"	23"	3-1/2"	1-15/16"	3/4"	15/16"	1-1/8"	
31154	1-11/16"	23"	3-1/2"	1-15/16"	3/4"	15/16"	1-1/8"	
31156	1-3/4"	25-1/2"	3-3/4"	2-1/16"	13/16"	1"	1-1/4"	
31158	1-13/16"	25-1/2"	3-3/4"	2-3/32"	13/16"	1"	1-1/4"	
31160	1-7/8"	28"	4-1/16"	2-3/16"	7/8"	1-1/16"	1-1/4"	
31164	2"	28"	4-1/16"	2-5/16"	7/8"	1-1/16"	1-1/4"	
31166	2-1/16"	28-1/4"	4-1/4"	2-11/16"	59/64"	1-7/32"	1-1/4"	
31168	2-1/8"	28-1/2"	4-1/4"	2-25/64"	59/64"	1-7/32"	1-1/4"	
31170	2-3/16"	28-3/4"	4-1/4"	2-27/64"	59/64"	1-7/32"	1-1/4"	
31172	2-1/4"	29"	4-1/4"	2-29/64"	59/64"	1-7/32"	1-1/4"	
31176	2-3/8"	29-1/4"	4-1/2"	2-15/32"	1"	1-9/16"	1-3/8"	
31180	2-1/2"	29-1/2"	4-1/2"	2-1/2"	1"	1-9/16"	1-3/8"	
1190	2-13/16"	33"	5-1/2"	3"	1-1/8"	1-11/16"	1-5/16"	1"
1192	2-7/8"	33-1/2"	5-1/2"	3"	1-3/16"	1-11/16"	1-5/16"	1"
1194	2-15/16"	34"	5-1/2"	3"	1-3/16"	1-11/16"	1-5/16"	1"
1196	3"	34-1/2"	5-1/2"	3"	1-3/16"	1-11/16"	1-5/16"	1"
1198	3-1/16"	35"	5-1/2"	3"	1-3/16"	1-11/16"	1-5/16"	1"
11X00	3-1/8"	35-1/2"	5-1/2"	3"	1-3/16"	1-11/16"	1-5/16"	1"
11X04	3-1/4"	36"	7"	4"	1-1/2"	2-1/4"	1-1/2"	1-1/8"
11X08	3-3/8"	36-1/2"	7"	4"	1-1/2"	2-1/4"	1-1/2"	1-1/8"
11X12	3-1/2"	37"	7"	3-7/8"	1-1/2"	2-1/4"	1-1/2"	1-1/8"
11X16	3-5/8"	37-1/2"	7"	3-7/8"	1-1/2"	2-1/4"	1-1/2"	1-1/8"
11X20	3-3/4"	38"	7"	3-13/16"	1-1/2"	2-1/4"	1-1/2"	1-1/8"
11X24	3-7/8"	38-1/2"	7"	3-13/16"	1-1/2"	2-1/4"	1-1/2"	1-1/8"
11X28	4"	39"	7"	3-13/16"	1-1/2"	2-1/4"	1-1/2"	1-1/8"

Meets or exceeds ASME B107.100

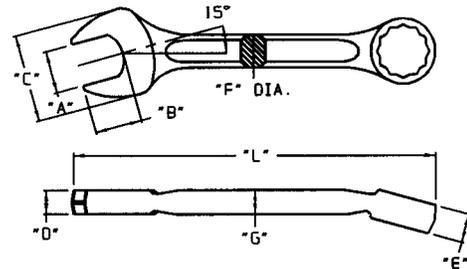

Wrenches



Combination & Open-End Wrenches

WRIGHT TOOL
PERFECTING PERFORMANCE

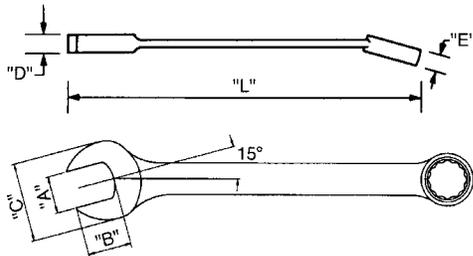

Metric Combination Wrenches – 12 Pt.

Black Industrial Finish

Part No.	A Nom. Size	L	C	B	D	E
41106	6mm	124.66	14.22	7.65	4.32	4.80
41107	7mm	132.26	15.39	8.51	4.67	5.31
41108	8mm	139.37	17.32	9.65	4.90	5.79
41109	9mm	147.40	19.38	9.88	5.33	6.43
41110	10mm	155.85	21.46	11.13	5.77	7.06
41111	11mm	165.13	23.47	13.42	6.20	7.70
41112	12mm	173.86	25.20	12.98	6.48	7.87
41113	13mm	181.76	26.92	15.75	6.73	8.51
41114	14mm	201.80	29.82	17.02	7.26	8.99
41115	15mm	209.25	31.42	17.02	7.82	9.63
41116	16mm	216.92	33.02	19.05	8.13	10.26
41117	17mm	231.78	36.07	20.57	8.59	11.18
41118	18mm	242.57	37.52	21.84	8.89	11.43
41119	19mm	255.24	39.12	21.86	9.17	11.68
41120	20mm	275.13	42.29	24.13	10.59	12.57
41121	21mm	286.97	43.92	23.42	10.92	12.93
41122	22mm	298.09	45.52	24.08	11.23	13.26
41123	23mm	308.81	46.94	24.38	11.58	13.39
41124	24mm	319.13	48.34	24.64	11.94	13.49

Meets or exceeds ASME B107.100

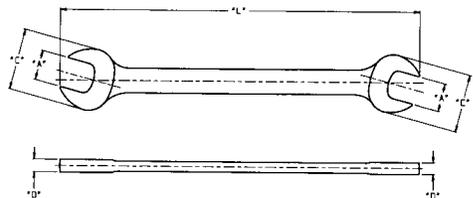

Open End Wrenches – Full Polish

Part No.	Small Open End			Large Open End		
	A Nom. Size	C Width	D Head Thick- ness	C Width	D Head Thick- ness	L Overall Length
1308	3/16 x 1/4"	13/32"	1/8"	9/16"	11/64"	3-7/8"
1310	1/4 x 5/16"	9/16"	11/64"	11/16"	11/64"	4-1/2"
1312	5/16 x 3/8"	11/16"	3/16"	13/16"	13/64"	5-1/8"
1314	3/8 x 7/16"	13/16"	13/64"	15/16"	7/32"	5-3/4"
1316	7/16 x 1/2"	15/16"	7/32"	1-1/16"	15/64"	6-3/8"
1318	1/2 x 9/16"	1-1/16"	17/64"	1-11/64"	9/32"	7"
1320	9/16 x 5/8"	1-3/16"	9/32"	1-19/64"	19/64"	7-5/8"
1322	5/8 x 11/16"	1-19/64"	5/16"	1-13/32"	11/32"	8-1/4"
1324	5/8 x 3/4"	1-19/64"	5/16"	1-17/32"	11/32"	8-5/8"
1325	11/16 x 3/4"	1-13/32"	11/32"	1-17/32"	11/32"	9-1/8"
1326	3/4 x 13/16"	1-17/32"	11/32"	1-21/32"	11/32"	9-3/4"
1328	3/4 x 7/8"	1-17/32"	11/32"	1-51/64"	23/64"	10-1/4"
1329	13/16 x 7/8"	1-21/32"	3/8"	1-25/32"	3/8"	10-3/4"
1330	7/8 x 15/16"	1-51/64"	3/8"	1-29/32"	25/64"	11-1/4"
1331	7/8 x 1-1/16"	1-51/64"	25/64"	2-9/64"	15/32"	11-13/16"
1332	15/16 x 1"	1-29/32"	13/32"	2-1/32"	7/16"	12-5/16"
1336	1-1/16 x 1-1/8"	2-9/64"	31/64"	2-1/4"	31/64"	13-15/16"
1340	1-1/8 x 1-1/4"	2-1/4"	31/64"	2-1/2"	1/2"	15-1/2"
1341	1-1/16 x 1-1/4"	2-9/64"	31/64"	2-1/2"	1/2"	16-1/8"
1342*	1-1/4 x 1-5/16"	2-1/2"	9/16"	2-21/32"	9/16"	16-37/64"
1346*	1-3/8 x 1-7/16"	2-27/32"	9/16"	3"	37/64"	17-1/8"
1352*	1-1/2 x 1-5/8"	3-3/32"	41/64"	3-13/32"	21/32"	18"

Meets or exceeds ASME B107.100

www.wrighttool.com



Wrenches

*Satin Finish





Metric Open-End Wrenches

Part No.	Nom. Size	Small Open End		Large Open End		
		A	C	C	D	L
		Width	Head Thickness	Width	Head Thickness	Overall Length
13-0607mm	6mmx7mm	14.29	4.36	17.46	4.36	114.30
13-0708mm	7mmx8mm	14.29	4.36	17.46	4.36	114.30
13-0809mm	8mmx9mm	17.46	4.76	20.64	5.16	130.18
13-1011mm	10mmx11mm	20.64	5.16	23.81	5.55	146.05
13-1213mm	12mmx13mm	23.81	5.55	26.99	5.95	161.93
13-1415mm	14mmx15mm	29.76	7.11	31.42	7.54	186.53
13-1617mm	16mmx17mm	33.32	7.92	35.72	8.73	209.55
13-1819mm	18mmx19mm	35.72	8.73	39.12	8.73	231.78
13-2022mm	20mmx22mm	42.07	9.53	45.24	9.53	273.05
13-2123mm	21mmx23mm	42.86	9.53	46.83	10.32	293.69
13-2426mm	24mmx26mm	48.42	10.32	51.59	11.11	312.74

Meets or exceeds ASME B107.100

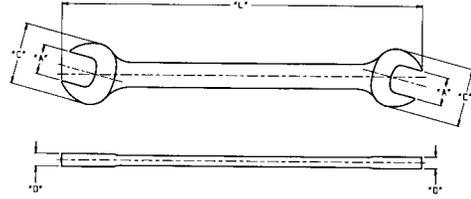

Wrenches



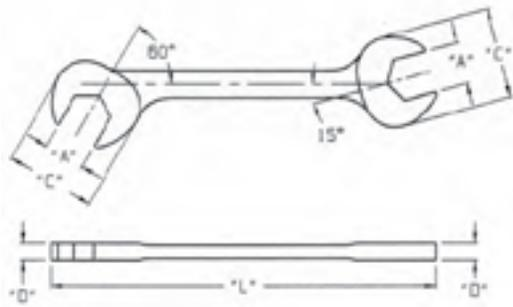

Double Angle Open-End Wrenches – 15° & 60° Angle

15° & 60° Angle Open-End Wrenches

Part No.	A Nom. Size	C Width	D Head Thickness	L Overall Length
1361	11/32" x 11/32"	3/4"	3/16"	4-3/4"
1362	3/8" x 3/8"	3/4"	3/16"	4-3/4"
1364	7/16" x 7/16"	7/8"	15/64"	5"
1366	1/2" x 1/2"	31/32"	15/64"	5-1/4"
1368	9/16" x 9/16"	1-1/16"	1/4"	5-3/4"
1370	5/8" x 5/8"	1-1/8"	17/64"	6-1/4"
1372	11/16" x 11/16"	1-3/16"	9/32"	6-3/4"
1374	3/4" x 3/4"	1-7/16"	9/32"	7-1/4"
1376	13/16" x 13/16"	1-1/2"	9/32"	7-5/8"
1378	7/8" x 7/8"	1-5/8"	9/32"	8"
1380	15/16" x 15/16"	1-3/4"	9/32"	8-3/4"
1382	1" x 1"	1-7/8"	19/64"	9-1/2"
1383	1-1/16" x 1-1/16"	2"	19/64"	10"
1384	1-1/8" x 1-1/8"	2-1/8"	5/16"	11"
1385	1 3/16" x 1 3/16"	2-1/8"	5/16"	11"
1386	1-1/4" x 1 1/4"	2-3/8"	21/64"	11-3/4"
1388	1-3/8" x 1-3/8"	2-5/8"	13/32"	12-1/2"
1389	1-7/16" x 1-7/16"	2-5/8"	13/32"	12-1/2"
1390	1-1/2" x 1-1/2"	2-5/8"	13/32"	12-1/2"
1392	1-5/8" x 1-5/8"	3-3/16"	19/64"	15-7/8"
1393	1-11/16" x 1-11/16"	3-5/16"	31/64"	16-9/16"
1394	1-3/4" x 1-3/4"	3-7/16"	1/2"	17-1/4"
1395	1-13/16" x 1-13/16"	3-9/16"	33/64"	18"
1396	1-7/8" x 1-7/8"	3-11/16"	35/64"	18-5/8"
1398	2" x 2"	3-15/16"	9/16"	19-1/4"

Meets or exceeds ASME B107.100



Wrenches





Box End Wrenches – 12 Pt. Standard Double Offset

Part No.	Nom. Size	A	C	E
51012	5/16 x 3/8"	9/16 x 41/64"	9/32"	7-1/32"
51214	3/8 x 7/16"	9/16 x 41/64"	9/32"	7-19/32"
51416	7/16 x 1/2"	21/32 x 3/4"	21/64"	8-3/16"
51618	1/2 x 9/16"	3/4 x 53/64"	11/32"	8-3/4"
51820	9/16 x 5/8"	53/64 x 29/32"	25/64"	9-3/8"
52022	5/8 x 11/16"	61/64 x 53/64"	15/32"	9-15/16"
52024	5/8 x 3/4"	31/32 x 1-5/64"	15/32"	11-15/32"
52224	11/16 x 3/4"	31/32 x 1-5/64"	15/32"	11-15/32"
52426	3/4 x 13/16"	1-5/64 x 1-1/4"	1/2"	12-1/16"
52428	3/4 x 7/8"	1-5/64 x 1-1/4"	1/2"	12-1/16"
52628	13/16 x 7/8"	1-1/8 x 1-1/4"	17/32"	12-9/16"
52830	7/8 x 15/16"	1-5/16 x 1-7/16"	37/64"	13-7/64"
52834	7/8 x 1-1/16"	1-9/16 x 1-11/32"	41/64"	14-7/16"
53032	15/16 x 1"	1-11/32 x 1-7/16"	9/16"	13-9/16"
53034	15/16 x 1-1/16"	1-9/16 x 1-11/32"	41/64"	14-7/16"
53436	1-1/16 x 1-1/8"	1-33/64 x 1-37/64"	21/32"	16-1/4"
53440	1-1/16 x 1-1/4"	1-33/64 x 1-25/32"	3/4"	16-1/4"
54042	1-1/4 x 1-5/16"	2 x 1-55/64"	27/32"	18-11/16"
54044	1-1/4 x 1-3/8"	2 x 1-55/64"	27/32"	18-11/16"
54046	1-1/4 x 1-7/16"	2 x 1-55/64"	27/32"	18-11/16"
54648	1-7/16 x 1-1/2"	2 x 2-1/4"	7/8"	22-5/16"
54652	1-7/16 x 1-5/8"	1-33/64 x 2-5/16"	7/8"	21-5/32"

Meets or exceeds ASME B107.100

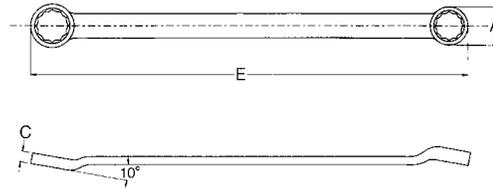

Metric Box End Wrenches – 12 Pt. Standard Double Offset

Part No.	Nom. Size	A	C	E
50810mm	8mm x 10mm	11.90 x 14.68	6.35	178.20
51011mm	10mm x 11mm	14.68 x 16.27	7.62	194.86
51113mm	11mm x 13mm	16.76 x 19.30	8.38	207.96
51213mm	12mm x 13mm	19.05 x 21.08	8.89	219.08
51214mm	12mm x 14mm	19.05 x 21.08	8.89	219.08
51315mm	13mm x 15mm	19.05 x 21.08	8.89	228.20
51415mm	14mm x 15mm	20.24 x 21.83	10.32	232.17
51618mm	16mm x 18mm	24.38 x 26.98	11.81	252.43
51719mm	17mm x 19mm	24.60 x 27.38	12.30	291.41
51922mm	19mm x 22mm	27.38 x 31.75	12.70	306.37
52224mm	22mm x 24mm	33.32 x 36.53	14.68	332.99

Meets or exceeds ASME B107.100

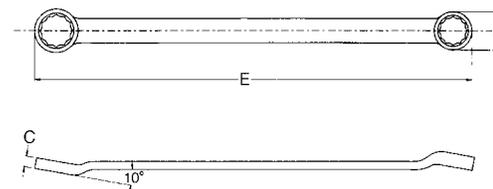

Wrenches



Flare Nut Wrenches

WRIGHT TOOL
PERFECTING PERFORMANCE

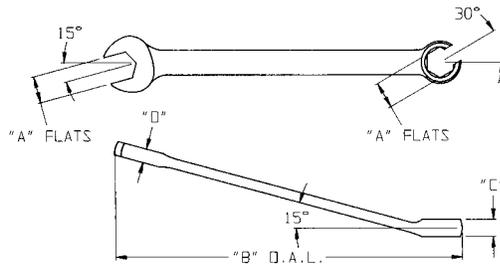

Combination Open-End Flare Nut Wrenches – 6 Pt.

Part No.	A Nom. Size	B	C & D
1040	3/8"	5-7/32"	13/32"
1042	7/16"	5-19/32"	7/16"
1044	1/2"	5-29/32"	15/32"
1046	9/16"	6-9/32"	15/32"
1048	5/8"	6-21/32"	1/2"
1050	11/16"	7-13/32"	35/64"
1052	3/4"	7-13/32"	35/64"

Meets or exceeds ASME B107.100

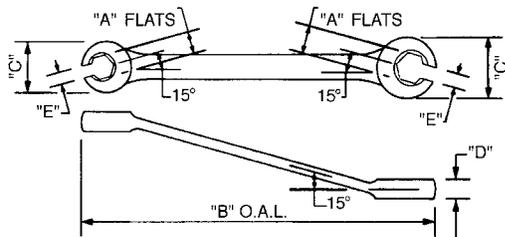

Flare Nut Wrenches – 6 Pt.

Part No.	A Nom. Size	B	C	D	E
1614	3/8"	6-1/4"	51/64"	5/16"	7/32"
	7/16"		7/8"	11/32"	9/32"
1618	1/2"	7-1/2"	31/32"	3/8"	11/32"
	9/16"		1-1/16"	7/16"	13/32"
1622	5/8"	8-1/2"	1-7/64"	7/16"	15/32"
	11/16"		1-15/64"	1/2"	17/32"
1628	3/4"	9"	1-5/16"	17/32"	9/16"
	7/8"		1-7/16"	9/16"	5/8"

Meets or exceeds ASME B107.100

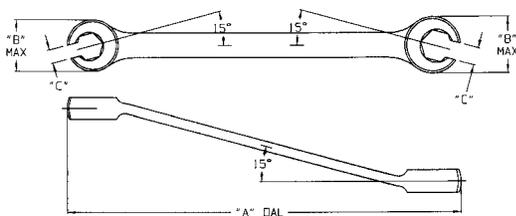

Metric Flare Nut Wrenches – 6 Pt.

Part No.	Nom. Size	A	B	C	Head Thickness
16-11mm	9mm	150.81	18.67	7.44	6.31
	11mm		21.44	8.10	7.47
16-12mm	10mm	163.51	20.14	7.70	7.57
	12mm		22.23	8.33	8.36
16-14mm	13mm	168.26	23.62	9.02	10.13
	14mm		25.40	9.70	10.87
16-17mm	15mm	187.33	28.65	10.62	13.28
	17mm		29.92	11.43	14.86
16-21mm	19mm	200.03	31.75	12.17	14.81
	21mm		35.36	12.65	18.11

Meets or exceeds ASME B107.100



Wrenches





Flare Nut Wrenches – 6 Pt.

Black Industrial Finish

Part No.	A Nom. Size	B	C	D	E
31614	3/8" 7/16"	6-1/4"	51/64" 7/8"	5/16" 11/32"	7/32" 9/32"
31618	1/2" 9/16"	7-1/2"	31/32" 1-1/16"	3/8" 7/16"	11/32" 13/32"
31622	5/8" 11/16"	8-1/2"	1-7/64" 1-15/64"	7/16" 1/2"	15/32" 17/32"

Meets or exceeds ASME B107.100

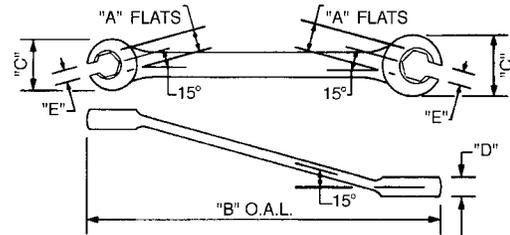

Ratcheting Flare Nut Wrenches – 12 Pt.

Part No.	Nom. Size	L	W	T	A	B	C
1642	3/8"	5.41"	1"	0.28"	.377-.392"	SAME	0.025"
1644	7/16"	5.41"	1"	0.28"	.443-.454"	.439-.454"	0.025"
1646	1/2"	5.41"	1"	0.28"	.506-.517"	.502-.517"	0.025"
1648	9/16"	7.25"	1.32"	0.38"	.570-.579"	.564-.579"	0.035"
1650	5/8"	7.25"	1.32"	0.38"	.633-.642"	.627-.542"	0.035"
1652	11/16"	7.25"	1.32"	0.38"	.696-.706"	.689-.706"	0.035"
1654	3/4"	7.25"	1.32"	0.38"	.759-.769"	.752-.769"	0.035"
1656	13/16"	9.35"	1.67"	0.44"	.814-.832"	SAME	0.040"
1658	7/8"	9.35"	1.67"	0.44"	.886-.895"	.877-.895"	0.040"
1660	15/16"	9.35"	1.67"	0.51"	.938-.958"	SAME	0.040"
1662	1"	9.35"	1.67"	0.51"	1.012-1.022"	1.002-1.02"	0.040"

Function:

Simply snap open the large jaw (smaller jaw cocks inward automatically) and the wrench is ready for operation. Engage fitting or fastener in the manner shown in the illustrations, and apply necessary torque. Move wrench in the opposite direction and the wrench ratchets with each 30° turn.

Specifications:

- High carbon steel jaws with black conversion coat finish.
- Heavy gauge, heat treated handles.
- Stainless steel rivets for maximum strength.
- Stainless steel jaw springs.
- Meets government specifications for NSN 5120-00-474-7227.

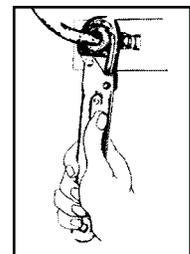
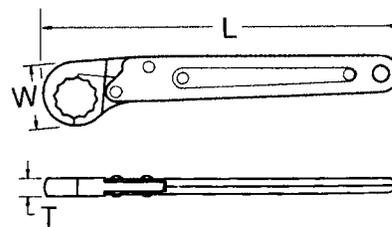
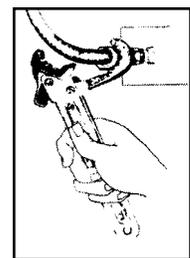
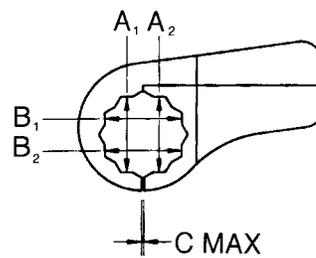

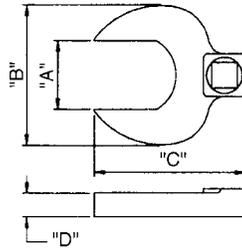
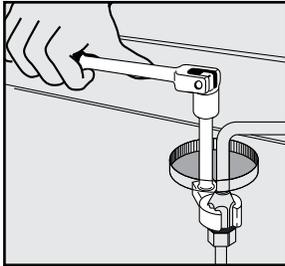

3/8" Drive Open-End Crowfoot Wrenches

Part No.	A Nom. Size	B	C	D
1012	3/8"	3/4"	1-1/8"	13/64"
1014	7/16"	7/8"	1-1/4"	13/64"
1016	1/2"	31/32"	1-3/8"	1/4"
1018	9/16"	1-1/8"	1-1/2"	1/4"
1020	5/8"	1-1/4"	1-19/32"	5/16"
1022	11/16"	1-11/32"	1-23/32"	21/64"
1024	3/4"	1-17/32"	1-13/16"	21/64"
1026	13/16"	1-19/32"	1-15/16"	21/64"
1028	7/8"	1-3/4"	2"	11/32"
1032	1"	2-1/16"	2-1/4"	11/32"

Meets or exceeds ASME B107.100

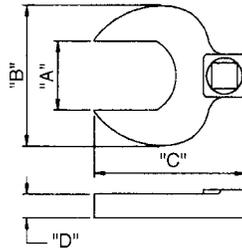
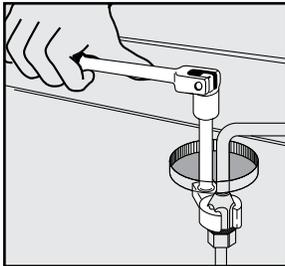

Metric 3/8" Open-End Crowfoot Wrenches

Part No.	A Nom. Size	B	C	D
10-10mm	10mm	19.84	30.16	5.16
10-11mm	11mm	22.23	32.15	5.16
10-12mm	12mm	24.60	34.93	6.35
10-13mm	13mm	24.60	34.93	6.35
10-14mm	14mm	29.37	34.13	6.35
10-15mm	15mm	29.37	38.89	7.14
10-16mm	16mm	31.75	41.28	8.33
10-17mm	17mm	35.32	42.86	8.33
10-18mm	18mm	35.32	44.45	8.33
10-19mm	19mm	39.69	45.24	8.73

Meets or exceeds ASME B107.100

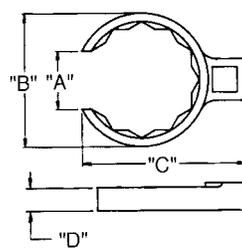
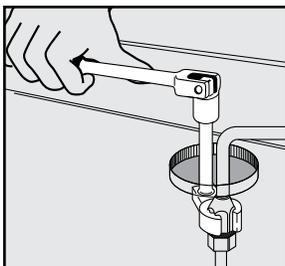

3/8" Drive Crowfoot Wrench - Flare Nut 12 Pt.

Part No.	Nom. Size	A Width of Slot	B Dia. of Head	C Length	D Thickness of Head
1060	5/8"	15/32"	15/16"	47/64"	11/16"
1062	11/16"	17/32"	1-1/32"	25/32"	11/16"
1064	3/4"	9/16"	1-1/8"	53/64"	23/32"
1066	13/16"	5/8"	1-13/64"	7/8"	23/32"
1068	7/8"	11/16"	1-19/64"	15/16"	3/4"
1070	15/16"	25/32"	1-3/8"	15/16"	3/4"
1072	1"	3/4"	1-29/64"	1-1/64"	25/32"
1074	1-1/16"	25/32"	1-17/32"	1-3/64"	25/32"

Meets or exceeds ASME B107.100





1/2" Drive Crowfoot Wrench – Flare Nut 12 Pt.

Part No.	Nom. Size	A Width of Slot	B Dia. of Head	D Thickness of Head
1080	1-1/8"	27/32"	1-5/8"	7/8"
1081	1-3/16"	29/32"	1-11/16"	7/8"
1082	1-1/4"	15/16"	1-25/32"	7/8"
1083	1-5/16"	31/32"	1-27/32"	7/8"
1084	1-3/8"	1-1/16"	1-15/16"	15/16"
1085	1-7/16"	1-1/16"	2"	15/16"
1086	1-1/2"	1-1/8"	2-1/16"	15/16"
1087	1-9/16"	1-5/32"	2-5/32"	15/16"
1088	1-5/8"	1-7/32"	2-7/32"	15/16"
1089	1-11/16"	1-5/16"	2-5/16"	1"
1090	1-3/4"	1-5/16"	2-3/8"	1"
1091	1-13/16"	1-11/32"	2-15/32"	1"
1092	1-7/8"	1-3/8"	2-9/16"	1-1/16"
1093	1-15/16"	1-7/16"	2-5/8"	1-1/16"
1094	2"	1-9/16"	2-23/32"	1-1/16"

Meets or exceeds ASME B107.100

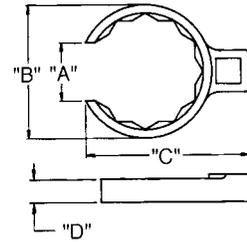
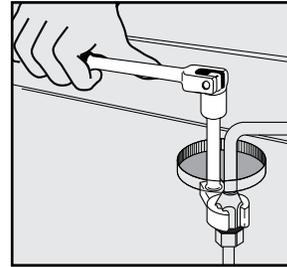

Service Wrenches – 30° Angle

Part No.	A Nom. Size	B	C	L
1424	3/4"	1-5/8"	7/32"	6-1/2"
1426	13/16"	1-5/8"	7/32"	6-1/2"
1428	7/8"	1-5/8"	7/32"	6-1/2"
1430	15/16"	1-7/8"	7/32"	6-7/8"
1432	1"	1-7/8"	7/32"	6-7/8"
1434	1-1/16"	1-7/8"	7/32"	6-7/8"
1436	1-1/8"	2-1/16"	7/32"	7-1/4"
1438	1-3/16"	2-1/16"	7/32"	7-1/4"
1440	1-1/4"	2-1/16"	7/32"	7-1/4"
1442	1-5/16"	2-1/2"	1/4"	7-11/16"
1444	1-3/8"	2-1/2"	1/4"	7-11/16"
1446	1-7/16"	2-1/2"	1/4"	7-11/16"
1448	1-1/2"	2-1/2"	1/4"	7-11/16"
1450	1-9/16"	2-5/8"	1/4"	8-1/16"
1452	1-5/8"	2-5/8"	1/4"	8-1/16"
1456	1-3/4"	3-1/8"	9/32"	8-9/16"
1458	1-13/16"	3-1/8"	9/32"	8-9/16"
1460	1-7/8"	3-1/8"	9/32"	8-9/16"
1462	1-15/16"	3-1/8"	9/32"	8-9/16"
1464	2"	3-1/2"	9/32"	9"
1468	2-1/8"	3-1/2"	9/32"	9"
1472	2-1/4"	3-1/2"	9/32"	9"

Meets or exceeds ASME B107.100

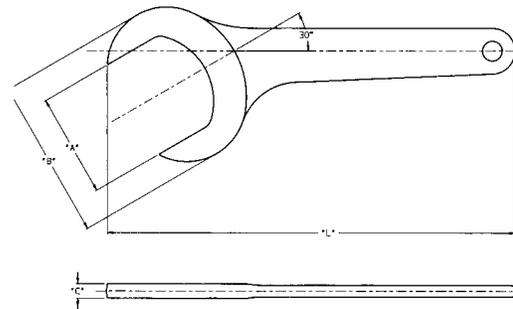

Wrenches



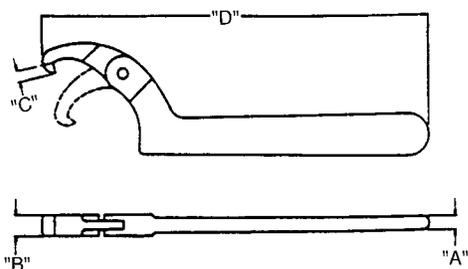

Adjustable Hook Spanner Wrenches

Black Industrial Finish

Part No.	Nom. Size	A Thickness of Handle	B Thickness of Hook	C Depth of Hook	D Length
9630	3/4 to 2"	1/4"	11/32"	1/8"	6-3/8"
9631	1-1/4 to 3"	9/32"	13/32"	5/32"	8-1/8"
9632	2 to 4-3/4"	5/16"	15/32"	3/16"	11-3/8"
9633	4-1/2 to 6-1/4"	5/16"	15/32"	1/4"	12-1/8"
9634	6-1/8 to 8-3/4"	5/16"	15/32"	5/16"	13-3/4"

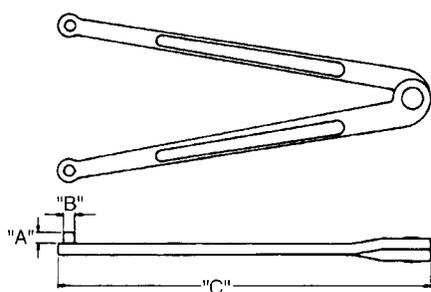

Adjustable Face Spanner Wrenches

Black Industrial Finish

Part No.	Extreme Capacity	A Length of Pin	B Dia. of Pin	C Overall Length
9636	2"	1/4"	3/16"	6-3/8"
9637	3"	1/4"	1/4"	8-1/4"
9638	4"	1/2"	5/16"	10-3/8"

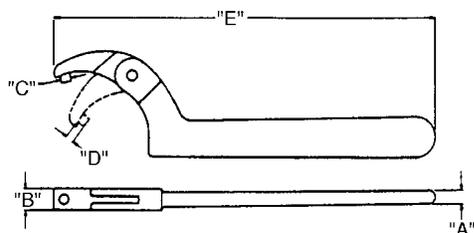

Adjustable Pin Spanner Wrenches

Black Industrial Finish

Part No.	Capacity Range	A Thickness Handle	B Pin Size Hook	C Overall Dia.	D Length	E Length
9640	3/4 to 2"	1/4"	11/32"	1/8"	1/8"	6-3/8"
9641	3/4 to 2"	1/4"	11/32"	3/16"	5/32"	6-3/8"
9642	1-1/4 to 3"	9/32"	13/32"	3/16"	3/16"	8-1/8"
9643	1-1/4 to 3"	9/32"	13/32"	1/4"	7/32"	8-1/8"
9644	2 to 4-3/4"	5/16"	15/32"	1/4"	1/4"	11-3/8"
9645	4-1/2 to 6-1/4"	5/16"	15/32"	3/8"	1/4"	12-1/8"



Wrenches





Adjustable Wrenches – Chrome Finish

Part No.	L Length	A Max Capacity
9AC04	4"	1/2"
9AC06	6"	15/16"
9AC08	8"	1-1/8"
9AC10	10"	1-3/8"
9AC12	12"	1-1/2"
9AC15	15"	1-11/16"
9AC18	18"	2-1/8"
9AC24	24"	2-17/32"

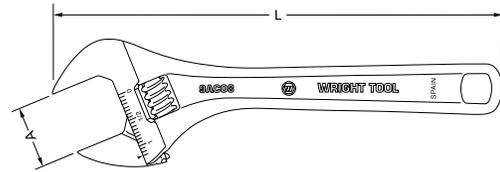

Adjustable Wrenches Black Industrial Finish

Part No.	L Length	A Max Capacity
9AB04	4"	1/2"
9AB06	6"	15/16"
9AB08	8"	1-1/8"
9AB10	10"	1-3/8"
9AB12	12"	1-1/2"
9AB15	15"	1-11/16"
9AB18	18"	2-1/8"
9AB24	24"	2-17/32"

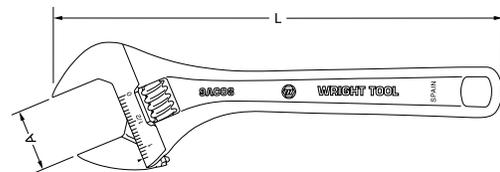

Adjustable Wrenches Cobalt Finish – Cushion Grip

Part No.	L Length	A Max Capacity
9AG04	4"	1/2"
9AG06	6"	15/16"
9AG08	8"	1-1/8"
9AG10	10"	1-3/8"
9AG12	12"	1-1/2"

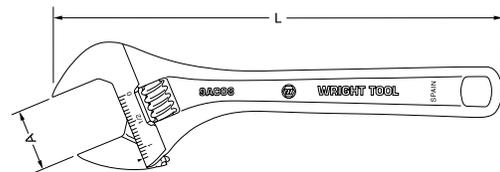

Giant Adjustable Wrench – 36"

Part No.	L Capacity	Head Thickness	Weight
9AC36	2-3/4" - 4-3/4" (in 1/8" increments)	1-1/8"	31 lbs.



Thin Profile Light Weight Adjustable Wrenches – Chrome-Plated

Part No.	L Length	Max Capacity
9AD06	6"	1-1/16"
9AD08	8"	1-1/4"
9AD10	10"	1-1/2"



Wrenches





RIDGID

Pipe Wrenches – Heavy-Duty Design

No. Part	Length	Max. Pipe Dia.
9R31000	6"	3/4"
9R31005	8"	1"
9R31010	10"	1-1/2"
9R31015	12"	2"
9R31020	14"	2"
9R31025	18"	2-1/2"
9R31030	24"	3"
9R31035	36"	5"
9R31040	48"	6"

GGG-W-651



Pipe Wrenches – Heavy-Duty Design – Aluminum

No. Part	Length	Max. Pipe Dia.
9R31090	10"	1-1/2"
9R31095	14"	2"
9R31100	18"	2-1/2"
9R31105	24"	3"
9R31110	36"	5"
9R31115	48"	6"

GGG-W-651



Wrenches





Flange Jacks

Easy-effect flange spreaders. Flanges are separated smoothly and evenly with no damage to flange faces. Sold in pairs.

Part No.	Dia. Capacity – Standard Raised Face Flanges			
	125 lbs. Cast Iron	150 lbs. Steel	250 lbs. Cast Iron	300 lbs. Steel
9460	2 to 20"	2 to 20"	1 to 12"	3/4 to 12"
9461	16 to 48"	18 to 24"	12 to 30"	12 to 24"



Construction – Structural Wrenches, Offset Head

Black Industrial Finish

Part No.	A Nom. Size	B	C	L
1726	13/16"	2"	17/32"	14-1/2"
1728	7/8"	2"	17/32"	14-1/2"
1730	15/16"	2"	17/32"	14-1/2"
1732	1"	2"	17/32"	14-1/2"
1734	1-1/16"	2-1/4"	5/8"	17"
1736	1-1/8"	2-1/4"	5/8"	17"
1740	1-1/4"	2-13/16"	11/16"	19"
1742	1-5/16"	2-13/16"	11/16"	19"
1746	1-7/16"	3-1/8"	3/4"	20"
1748	1-1/2"	3-1/8"	3/4"	20"
1752	1-5/8"	3-19/32"	13/16"	23"

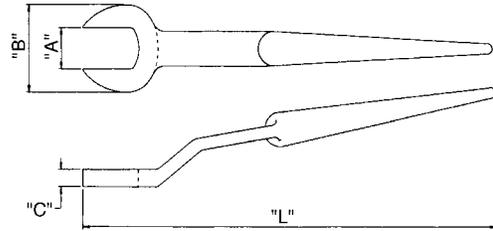

Part No.	Nom. Size	Nut Type	Bolt Size
1726	13/16"	U.S. Regular	1/2"
1728	7/8"	U.S. Heavy	1/2"
1730	15/16"	Utility	5/8"
1732	1"	U.S. Regular	5/8"
1734	1-1/16"	U.S. Heavy	5/8"
1736	1-1/8"	U.S. Regular	3/4"
1740	1-1/4"	U.S. Heavy	3/4"
1742	1-5/16"	U.S. Regular	7/8"
1746	1-7/16"	U.S. Heavy	7/8"
1748	1-1/2"	U.S. Regular	1"
1752	1-5/8"	U.S. Heavy	1"



Wrenches



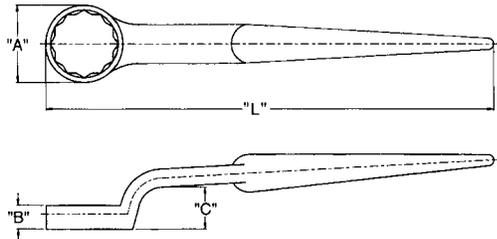

Construction – Structural ¹²Pt. Spud Handle Box Wrenches

Black Industrial Finish

Part No.	Nom. Size	A	B	C	L
1756	13/16"	1-15/32"	11/16"	1-25/32"	12"
1758	7/8"	1-15/32"	11/16"	1-25/32"	12"
1760	15/16"	1-5/8"	13/16"	1-61/64"	12"
1762	1"	1-5/8"	13/16"	1-61/64"	12"
1764	1-1/16"	1-53/64"	7/8"	2-9/64"	15"
1766	1-1/8"	1-53/64"	7/8"	2-9/64"	15"
1770	1-1/4"	2-5/64"	15/16"	2-21/64"	17"
1772	1-5/16"	2-5/64"	15/16"	2-21/64"	17"
1776	1-7/16"	2-3/8"	1-1/8"	2-3/4"	21"
1778	1-1/2"	2-3/8"	1-1/8"	2-3/4"	21"
1782	1-5/8"	2-5/8"	1-3/16"	2-7/8"	22"
1784	1-11/16"	2-5/8"	1-3/16"	2-7/8"	22"
1788	1-13/16"	2-29/32"	1-1/4"	3"	23"
1790	1-7/8"	2-29/32"	1-1/4"	3"	23"
1794	2"	3-5/32"	1-3/8"	3-5/32"	24-1/2"
1795	2-3/16"	3-15/32"	1-1/2"	3-1/2"	26"
1796	2-3/8"	3-23/32"	1-5/8"	3-11/16"	28"
1797	2-9/16"	3-29/32"	1-3/4"	3-13/16"	30"
1798	2-3/4"	4-5/32"	1-7/8"	3-29/32"	30"

* Some items may be special order.

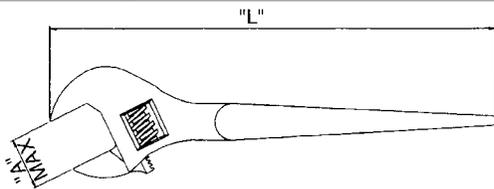

Adjustable Construction Wrench

Black Industrial Finish

No. Part	A Max.	L
9413	1-1/8"	10"
9414	1-19/32"	16"

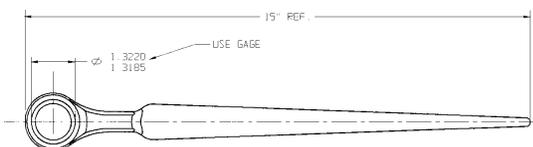

Construction Spud Ratchet

Black Industrial Finish

Features 1/2" drive and a heavy-duty round head. Requires only 4° arc swing for tight spots.

Part No.	L Overall Length	No. of Teeth	A Head Dia.	Renewal Kit No.
4428	15"	45	1-5/8"	34491





Broad Head Bull Pins

Part No.	Top Diameter	Point Diameter	Length
9A649	1-1/16"	1/4"	10-3/8"
9A650	1-1/4"	5/16"	13-3/4"

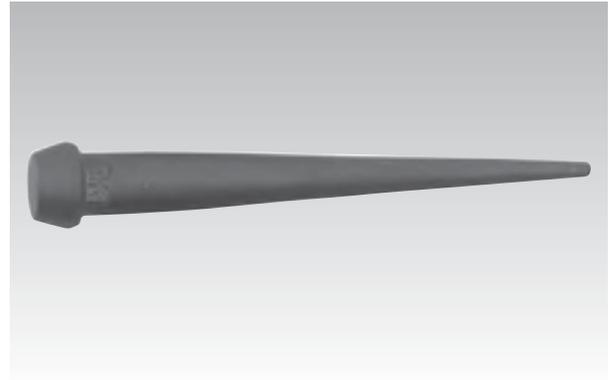

Barrel Pins

Part No.	Size	Overall Length	Length Of Taper	Point Size
9A611	7/16"	6"	2"	3/16"
9A613	11/16"	6"	2"	5/16"
9A634	13/16"	8"	2-1/2"	3/8"
9A635	15/16"	8"	2-1/2"	7/16"
9A636	1-1/16"	8"	2-1/2"	9/16"
9A637	1-3/16"	8"	2-1/2"	3/4"
9A638	1-5/16"	8"	2-1/2"	3/4"



Slugging Wrench Adaptor

Part No.	Description
1900	1"M x 1"F



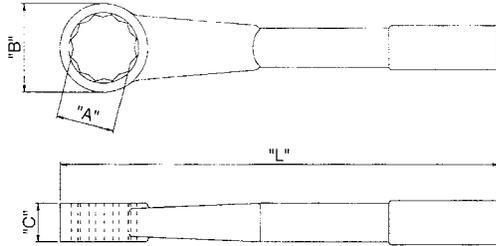

Straight Handle Striking Face Box Wrenches ¹²Pt. – Heavy Duty

Black Industrial Finish

Part No.	A Nom. Size	B Dia. of Head	C Thickness of Head	L Overall Length
1832	1"	1-25/32"	5/8"	9-1/8"
1834	1-1/16"	1-25/32"	5/8"	9-1/8"
1836	1-1/8"	1-25/32"	5/8"	9-7/8"
1838	1-3/16"	2"	3/4"	10-1/4"
1840	1-1/4"	2"	3/4"	10-1/4"
1842	1-5/16"	2"	3/4"	10-1/4"
1844	1-3/8"	2-17/64"	7/8"	10-9/16"
1846	1-7/16"	2-17/64"	7/8"	10-7/16"
1848	1-1/2"	2-17/64"	7/8"	10-7/16"
1852	1-5/8"	2-31/64"	1"	11"
1854	1-11/16"	2-31/64"	1"	11"
1856	1-3/4"	2-21/32"	1-1/8"	11-5/16"
1858	1-13/16"	2-21/32"	1-1/8"	11-5/16"
1860	1-7/8"	2-21/32"	1-1/8"	11-5/16"
1864	2"	3-1/32"	1-1/4"	11-11/16"
1866	2-1/16"	3-7/32"	1-1/4"	11-11/16"
1868	2-1/8"	3-9/32"	1-3/8"	12"
1870	2-3/16"	3-9/32"	1-3/8"	12"
1872	2-1/4"	3-13/32"	1-1/2"	12-3/8"
1874	2-5/16"	3-13/32"	1-1/2"	12-3/8"
1876	2-3/8"	3-13/32"	1-1/2"	12-3/8"
1880	2-1/2"	3-3/4"	1-3/8"	12-11/16"
1882	2-9/16"	3-3/4"	1-3/8"	12-11/16"
1884	2-5/8"	3-3/4"	1-5/8"	12-11/16"
1886	2-11/16"	4-11/64"	1-3/4"	13-1/16"
1888	2-3/4"	4-11/64"	1-3/4"	13-1/16"
1889	2-15/16"	4-23/64"	1-7/8"	13-7/16"
1889A	3"	4-31/64"	2"	13-13/16"
1890	3-1/8"	4-31/64"	2"	13-13/16"
1890A	3-3/8"	4-31/64"	2-1/4"	14-1/8"
1891	3-1/2"	4-31/64"	2-1/4"	14-1/8"
1891A	3-3/4"	5-25/64"	2-1/2"	14-1/2"
1892	3-7/8"	5-35/64"	2-1/2"	14-1/2"
1894	4-1/8"	6-1/2"	2-3/4"	16"
1895	4-1/4"	6-1/2"	2-3/4"	16"
1896	4-1/2"	7"	3"	18"
1897	4-5/8"	7"	3"	18"

Meets or exceeds ASME B107.59





Offset Handle Striking Face Box Wrenches – 12 Pt.

Black Industrial Finish

Part No.	A Nom. Size	B Dia. of Head	C Thickness of Head	L Overall Length
1932	1"	1-3/4"	13/16"	10-1/2"
1934	1-1/16"	1-3/4"	13/16"	10-1/2"
1936	1-1/8"	1-3/4"	13/16"	10-1/2"
1938	1-3/16"	2"	13/16"	11"
1940	1-1/4"	2"	29/32"	11"
1942	1-5/16"	2"	29/32"	11"
1946	1-7/16"	2-3/8"	1"	11-1/2"
1948	1-1/2"	2-3/8"	1"	11-1/2"
1952	1-5/8"	2-1/2"	1-1/16"	12"
1954	1-11/16"	2-1/2"	1-1/16"	12"
1956	1-3/4"	2-7/8"	1-1/8"	12-1/2"
1958	1-13/16"	2-7/8"	1-1/8"	12-1/2"
1960	1-7/8"	2-7/8"	1-1/8"	12-1/2"
1962	1-15/16"	3"	1-1/4"	13"
1964	2"	3"	1-1/4"	13"
1968	2-1/8"	3-1/2"	1-3/8"	13-1/2"
1970	2-3/16"	3-1/2"	1-3/8"	13-1/2"
1972	2-1/4"	3-1/2"	1-3/8"	13-1/2"
1974	2-5/16"	3-23/32"	1-1/2"	14"
1976	2-3/8"	3-23/32"	1-1/2"	14"
1980	2-1/2"	4-5/16"	1-3/4"	15-1/4"
1982	2-9/16"	4-5/16"	1-3/4"	15-1/4"
1984	2-5/8"	4-5/16"	1-3/4"	15-1/4"
1988	2-3/4"	4-5/16"	1-3/4"	15-1/4"
1992	2-7/8"	4-13/16"	1-7/8"	16"
1989	2-15/16"	4-13/16"	2"	16-1/2"
1996	3"	4-13/16"	2"	16-1/2"
1997	3-1/8"	4-13/16"	2"	16-1/2"
19108	3-3/8"	6-1/4"	2-3/8"	18"
19112	3-1/2"	6-1/4"	2-3/8"	18"
19120	3-3/4"	6-1/4"	2-3/8"	18"
19124	3-7/8"	6-1/4"	2-3/8"	18"
19132	4-1/8"	6-1/4"	2-3/8"	18"
19136	4-1/4"	6-1/4"	2-3/8"	18"

Meets or exceeds ASME B107.59

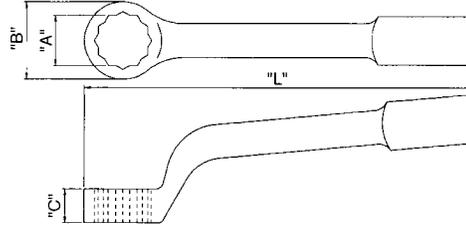

Wrenches



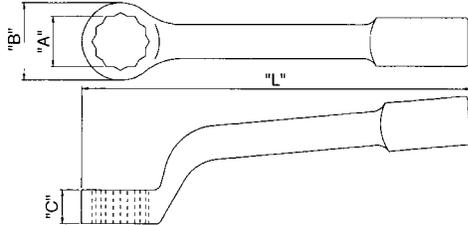

Metric Offset Handle Striking Face Box Wrenches – 12 Pt.

Black Industrial Finish

Part No.	A Nom. Size	B Dia. of Head	C Thickness of Head	L Overall Length
19-32mm	32mm	50.80	23.02	279.40
19-36mm	36mm	60.33	25.40	292.10
19-41mm	41mm	63.50	26.99	304.80
19-46mm	46mm	73.03	28.58	317.50
19-50mm	50mm	76.20	31.75	330.20
19-55mm	55mm	88.90	34.93	342.90
19-60mm	60mm	94.45	38.10	355.60
19-65mm	65mm	109.54	44.45	387.35
19-70mm	70mm	109.54	44.45	387.35
19-75mm	75mm	122.24	50.80	419.10
19-80mm	80mm	122.24	50.80	419.10

Meets or exceeds ASME B107.59

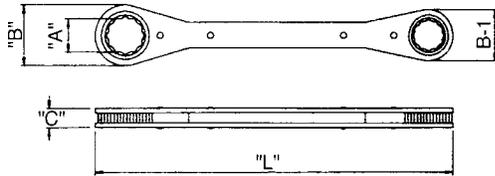

Metric Ratcheting Box Wrenches – 12 Pt.

Part No.	A Nom. Size	B	B-1	C	L
9416	7 x 8mm	16.27	15.48	9.53	107.95
9417	9 x 10mm	22.62	19.84	9.53	139.70
9418	11 x 12mm	32.54	25.40	12.70	171.45
9419	13 x 14mm	32.54	25.40	12.70	171.45
9421	15 x 17mm	36.51	32.94	12.70	203.20
9422	16 x 18mm	36.51	32.94	12.70	203.20
9423	19 x 21mm	40.08	35.72	12.70	234.95





Metric Offset Ratcheting Box Wrenches – 12 Pt. Reversible

Part No.	A Nom. Size	B	B-1	C	L
9431	7 x 8mm	15.88	15.08	4.25	107.95
9432	9 x 10mm	22.23	19.84	7.94	136.53
9434	11 x 12mm	29.37	25.40	7.94	171.45
9435	13 x 14mm	29.37	25.40	7.94	171.45

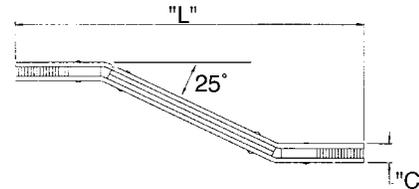
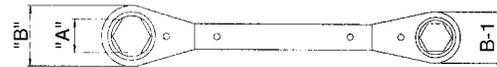

Metric Offset Ratcheting Box Wrenches – 12 Pt. Reversible

Part No.	A Nom. Size	B	B-1	C	L
9436	15 x 17mm	36.51	32.54	9.53	203.20
9437	16 x 18mm	36.51	32.54	9.53	206.38
9438	19 x 21mm	39.69	35.72	9.53	231.76

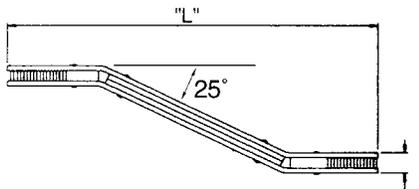

Ratcheting Box Wrenches – 12 Pt.

Part No.	A Nom. Size	B	B-1	C	L
9381	1/4 x 5/16"	5/8"	19/32"	5/16"	4-1/4"
9382	3/8 x 7/16"	7/8"	25/32"	5/16"	5-1/2"
9383	1/2 x 9/16"	1-5/32"	1-1/16"	1/2"	6-7/8"
9383A	9/16 x 3/4"	1-7/16"	1-19/64"	1/2"	8/1/8"
9383B	9/16 x 5/8"	1-7/16"	1-19/64"	1/2"	8-1/8"
9384	5/8 x 11/16"	1-7/16"	1-9/32"	1/2"	8"
9385	5/8 x 3/4"	1-7/16"	1-9/32"	1/2"	8"
9386	3/4 x 7/8"	1-9/16"	1-13/32"	1/2"	9-1/4"
9387	13/16 x 15/16"	1-5/8"	1-7/16"	–	9-1/4"
9390	1 x 1-1/16"	2-1/4"	1-29/32"	1/2"	15"
9388	1-1/16 x 1-1/4"	1-7/8"	1-3/4"	–	15"
9389	1-1/8 x 1-1/4"	1-15/16"	1-3/4"	–	15"

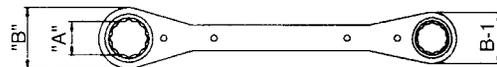

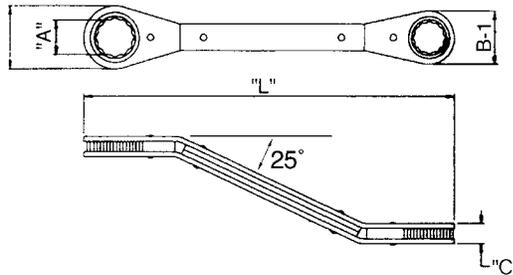

Offset Ratcheting Box Wrenches – 12 Pt. Reversible

Part No.	A Nom. Size	B	B-1	C	L
9424	1/4 x 5/16"	21/32"	19/32"	5/16"	4-1/4"
9425	3/8 x 7/16"	7/8"	25/32"	5/16"	5-1/2"
9426	1/2 x 9/16"	1-5/32"	1-1/32"	3/8"	6-1/2"
9427	5/8 x 11/16"	1-7/16"	1-9/32"	3/8"	7-7/8"
9428	3/4 x 7/8"	1-9/16"	1-13/32"	3/8"	8-3/4"

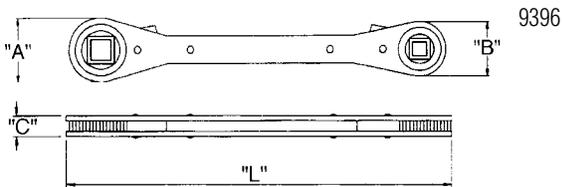

Air Conditioning & Refrigeration Ratcheting Box Wrenches, Reversible

These 4 sizes in 1 ratchets are specifically designed for servicing automotive, commercial and home air conditioners, refrigeration units and freezers. They have the "finger tip" reversing feature on both ends.

Part No.	Description	A	B	C	L
9396	1/4"-3/16" Sq. x 3/8"-5/16" Sq.	29/32"	25/32"	5/16"	5-5/8"
9397	1/4"-3/16" Sq. x 9/16"-1/2" Hex	1-9/64"	1"	3/8"	7"

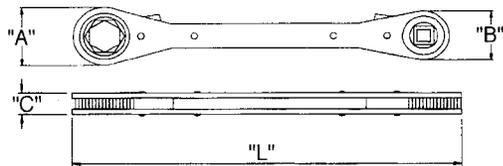

Wrenches





Drum Cap Opening Tool

Part No. Description

9005 Drum Cap Opening Tool
Fits 55 and 30 gallon drums. Removes "screw-in" style plugs (caps) for most steel and plastic drums with large and small plugs. Handy, built-in "two-hand" twist handle easily helps open the tightest plugs. Fits all twelve (12) drum plugs (bungs) illustrated. Packed bulk-weight 3.0 Lbs. each.

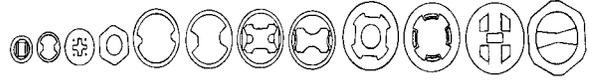

Wrenches





Wright sockets feature the patented Wright Drive, which provides more torque with less fastener damage.

Wright's wide range of ratchets meet your every need: double-pawl ratchets in 3/8" and 1/2" drives provide ruggedness, extra strength, durability and fine tooth action. We also have the handles and attachments you're looking for—from extensions and spinners to universals and flex handles.



SOCKETS, RATCHETS & ATTACHMENTS.

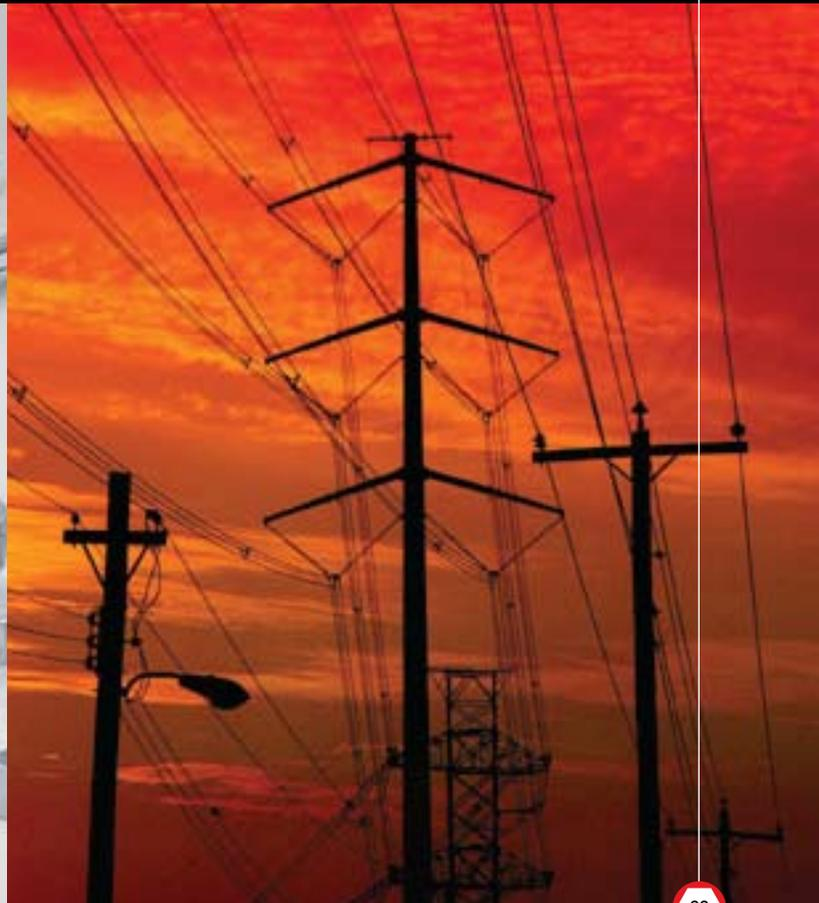



W A R N I N G !

HAND SOCKETS, HANDLES & ATTACHMENTS

- Users and bystanders must wear safety goggles.
- To avoid possible eye injury from flying objects, safety goggles or equivalent protection conforming to ANSI Z87.1 shall be worn and kept clean by the user and all persons in the immediate area where any tool is being used.
- Comfort or plastic grips on handles are not intended to give any degree of protection against electric shock and shall not be used on or near live electric circuits.
- Never use hand sockets or hand attachments on power drivers, impact drivers or hydraulic drivers. Black industrial sockets, torx sockets and torx bit sockets are designed and finished to be hand sockets – not impact.
- Never use cheater bars to increase handle leverage.
- Never hammer on a ratchet or handle.
- Never use ratchets or other handles as a hammer or pry bar.
- Hand sockets are to be attached to ratchets and handles and used by hand to turn fasteners.
- Users shall apply a controlled force with a stance adjusted and braced to prevent rapid bodily movement or a fall if sudden release occurs.
- Use the correct size socket, do not use metric sockets on inch fasteners or inch sockets on metric fasteners, because the fit is not good enough. Do not use hex sockets on square fasteners or square sockets on hex fasteners.
- Place the socket all the way on the fastener.
- Adaptor strength is limited to the smallest drive square member.
- Never use sockets as a driver for hex or square bits or shafts.
- Inspect and discard bent, worn or cracked sockets, handles or attachments.
- Socket opening configurations shall be inspected before each use and their use discontinued at the first sign of significant wrenching surface deterioration.

IMPACT SOCKETS

- Users and bystanders must wear safety goggles.
- To avoid possible eye injury from flying objects, safety goggles or equivalent protection conforming to ANSI Z87.1 shall be worn and kept clean by the user and all persons in the immediate area where any tool is being used.
- Do not hold impact sockets, universal joints or extensions while an impact tool is running. Serious hand injury can occur.
- 3/4" drive and larger drive size impact sockets require the use of a ret ring or a Pin & O-ring to secure the socket to the driving square.
- Never use a nail or homemade pin for holding a socket in place.
- Never exceed the manufacturer's gun pressure rating.
- Impact sockets are to be used to turn (tighten or loosen) fasteners while being driven by a power, impact or hydraulic driver.
- Never dwell on a socket after it has stopped running. This can damage both the socket and the fastener.
- Place the socket all the way on the fastener before starting the gun.
- Adaptor strength is limited to the smallest drive square member.
- Mind the joints between the gun and fasteners for less loss of torque and less wear.
- Use the correct size socket, do not use metric sockets on inch fasteners or inch sockets on metric fasteners, because the fit is not good enough. Do not use hex sockets on square fasteners or square sockets on hex fasteners.
- Never use sockets as a driver for hex or square bits or shafts.
- Large drive impact sockets are inherently heavy and care needs to be taken during handling.
- Socket opening configurations shall be inspected before each use and their use discontinued at the first sign of significant wrenching surface deterioration.
- Inspect and discard worn or cracked sockets.



WRIGHT DRIVE... More Strength. More Torque. Longer Tool Wear.

12-pt. Wright Drive tools give you ten times more fastener contact!

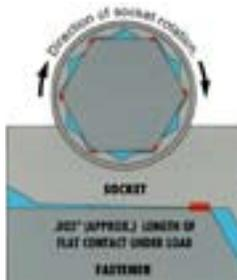

Conventional.

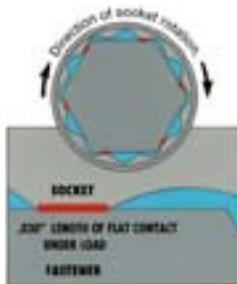

First Generation.

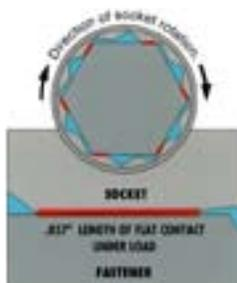

Wright Drive.

The Wright Drive® 12-point design distributes contact stress more effectively than any other wrench system available. It spreads stress evenly over a larger contact area and away from the fastener corners. The result is up to ten times more tool-to-fastener contact area than conventional wrenches. This design improves fastener torque load while decreasing rounding and distortion of the fastener. To better understand the advantages of the 12-point design, one must look at the designs that led to the introduction of the Wright Drive.

Conventional designs put all of the load too close to the fastener corner. Extra fasteners were used to share the load. This was fine when over-engineered products required low-torque fasteners. But industry moved away from over-engineering. As the demand for high-torque fasteners increased, so did the demand for a new generation of high-torque tools. Today, every fastener should be fully tightened. Installation is more demanding and removal is more difficult.

Approximate .005" length of flat contact at engagement under load with 5/8" conventional design and SAE Grade 5 fastener.

Early First Generation designs concentrated on reducing the rounding of fastener corners by moving the stress zone farther away from the corner. However, these modifications— known as First Generation AS954 tools—result in a reduction of leverage. While First Generation designs reduce the tendency to round fastener corners, the relatively limited flat contact area still tends to mark, indent and distort fasteners and fittings made of soft steel and brass.

Maximum .030" length of flat contact at engagement under load with 5/8" first generation AS954 design and SAE Grade 5 fastener.

The Wright Drive was created and patented by the Wright Tool Company, taking full advantage of advanced CAD/CAM technologies. It actually improves the torque load capabilities of every fastener, whether it's a soft stove bolt or a hardened aerospace fastener.

- Torque loads are moved away from fastener corners to prevent rounding.
- Stress is distributed over a much larger area of the fastener.
- Leverage is improved, eliminating fastener rounding and increasing tool strength.
- Tool-to-fastener contact area is ten times greater than with a conventional design, and almost twice that of a First Generation AS954 tool.

Maximum .057" length of flat contact at engagement under load with 5/8" Wright Drive design and SAE Grade 5 fastener.



Conventional. This Finite Element Analysis display shows that ordinary sockets create extremely high stress loads at the fastener corner and at the socket's inside corners. The illustration shows that this stress is concentrated in a very small area.



First Generation. While stress is relieved on the fastener corner, there is no significant improvement in relieving concentrated stress on the inside surfaces of the socket.



Wright Drive. The Wright Drive distributes stress evenly across the socket and fastener faces, away from the fastener corners, and over a larger flat contact area than ordinary sockets allow. There is a significant improvement in distribution of stress at the socket's inside surface.

6-pt. Wright Drive tools have greater strength & torque, plus better gripping power!



The patented 6-point Wright Drive is, in effect, a careful blending of Wright's 12-point design with the heavy-duty gripping characteristics of a traditional 6-point wrench opening. It offers many of the same advantages of the 12-point design, including greater strength, more torque and reduced rounding of the fastener corners. Patent No. 5,284,073.

The main advantage of the 6-pt. design is its gripping power. The Wright Drive's minor circle diameter, which is a measure of the ability to grip an undersized fastener, is exactly the same as a traditional 6-point opening. The smaller the diameter, the better the grip on undersized fasteners and fasteners with badly rounded corners.

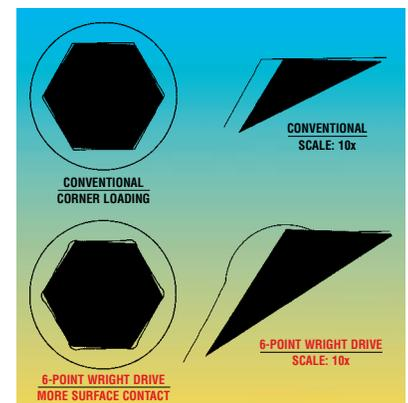



Wright Tool Leads in Impact Sockets



Impact tools save time and handle high torques with less effort and more safety. Wright Tool makes impact sockets and attachments for almost every size and drive for which we make a hand socket because no hand socket is recommended for impact gun use. Wright impact tools are stronger and tougher to withstand the repeated high loads produced by impact guns, which are often higher than can be produced by hand. Wright impact sockets are always black, not only to distinguish them from hand sockets, which are usually plated, but also to avoid the chipping which could occur when a plated socket is subjected to thousands of cycles of very high loads. (Wright and other manufacturers make some black finish hand tools for specialized applications. These are not for impact use.)

Wright 6 pt. sockets use the patented Wright Drive® design for greater strength and longer life. Wright Tool also manufactures 12 pt. impact sockets with our Wright Drive® design.

In addition, Wright makes large impact sockets which are beyond the range of hand application. These go up to 10" opening and 3-1/2" drive. The 2-1/2" and 3-1/2" drive sockets are normally driven with hydraulic power. Because of the high loads involved, the impact designs are much safer for these drivers. While 1-1/2" impact guns are available, the hydraulic driver is often more convenient to use and has the advantage of controlling the amount of torque applied.

Wright Tool stocks a large assortment of impact sockets including 1-1/2" drive inch and metric sizes through 6-1/2" and 155mm. The 2-1/2" and 3-1/2" drive sockets are custom made with prompt delivery. Also, deep sockets and sizes that we do not stock can be quickly manufactured to order.

Each Wright impact socket is designed for its drive size because the drive size limits the torque that may be applied.



12 Pieces – 6 Pt. Standard Socket Set Set No. 212

Part No.	Description	Part No.	Description
2006	3/16"	2014	7/16"
2007	7/32"	2016	1/2"
2008	1/4"	2492	Ratchet
2009	9/32"	2402	2" Extension
2010	5/16"	2441	Spinner
2011	11/32"	11	Metal Box
2012	3/8"		



18 Pieces – 6 Pt. Standard & Special 8 Pt. Standard Socket Set Set No. 218

Part No.	Description	Part No.	Description
6 Pt. Standard Sockets			
2006	3/16"	2011	11/32"
2007	7/32"	2012	3/8"
2008	1/4"	2014	7/16"
2009	9/32"	2016	1/2"
2010	5/16"		
Special 8 Pt. Standard Sockets			
2308	1/4"	2312	3/8"
2310	5/16"		
Attachments			
2492	Ratchet	2441	Spinner
2402	2" Extension	2475	Universal
2406	6" Extension	11	Metal Box
2435	Flex Handle		



23 Pieces – 6 Pt. Standard & Deep Socket Set Set No. 223

Part No.	Description	Part No.	Description
6 Pt. Standard Sockets			
2005	5/32"	2010	5/16"
2006	3/16"	2011	11/32"
2007	7/32"	2012	3/8"
2008	1/4"	2014	7/16"
2009	9/32"	2016	1/2"
6 Pt. Deep Sockets			
2506	3/16"	2511	11/32"
2508	1/4"	2512	3/8"
2509	9/32"	2514	7/16"
2510	5/16"	2516	1/2"
Attachments			
2492	Ratchet	2441	Spinner
2402	2" Extension	2475	Universal
2406	6" Extension	13	Metal Box

1/4"



Sockets, Ratchets & Attachments





35 Pieces – 6, 12 & Special 8 Pt. Standard Socket, 6 & 12 Pt. Deep Socket & Screwdriver Socket with Bit Set
Set No. 236

Part No.	Description	Part No.	Description
6 Pt. Standard Sockets			
2006	3/16"	2011	11/32"
2007	7/32"	2012	3/8"
2008	1/4"	2014	7/16"
2009	9/32"	2016	1/2"
2010	5/16"		
12 Pt. Standard Socket			
2118	9/16"		
Special 8 Pt. Standard Sockets			
2308	1/4"	2312	3/8"
2310	5/16"		
6 Pt. Deep Sockets			
2506	3/16"	2511	11/32"
2507	7/32"	2512	3/8"
2508	1/4"	2514	7/16"
2509	9/32"	2516	1/2"
2510	5/16"		
12 Pt. Deep Socket			
2618	9/16"		
Screwdriver Sockets with Bits			
2260 (9204)	3/16"	2265 (9200)	#1
2261 (9205)	1/4"	2266 (9201)	#2
2263 (9203)	23/64"		
Attachments			
2492	Ratchet	2435	Flex handle
2402	2" Extension	2441	Spinner
2404	4" Extension	2475	Universal
2406	6" Extension	13	Metal Box



10 Pieces – 6 Pt. Standard Socket Set
Set No. 200

Part No.	Description	Part No.	Description
2005	5/32"	2011	11/32"
2006	3/16"	2012	3/8"
2007	7/32"	2014	7/16"
2008	1/4"	2016	1/2"
2009	9/32"	W008	Rail
2010	5/16"	W2	10 Clips



1/4"



Sockets, Ratchets & Attachments





10 Pieces – 12 Pt. Standard Socket Set Set No. 209

Part No.	Description	Part No.	Description
2106	3/16"	2112	3/8"
2107	7/32"	2114	7/16"
2108	1/4"	2116	1/2"
2109	9/32"	2118	9/16"
2110	5/16"	W008	Rail
2111	11/32"	W2	10 Clips



9 Pieces – 6 Pt. Deep Socket Set Set No. 208

Part No.	Description	Part No.	Description
2506	3/16"	2512	3/8"
2507	7/32"	2514	7/16"
2508	1/4"	2516	1/2"
2509	9/32"	W008	Rail
2510	5/16"	W2	9 Clips
2511	11/32"		



10 Pieces – 12 Pt. Deep Socket Set Set No. 210

Part No.	Description	Part No.	Description
2606	3/16"	2612	3/8"
2607	7/32"	2614	7/16"
2608	1/4"	2616	1/2"
2609	9/32"	2618	9/16"
2610	5/16"	W008	Rail
2611	11/32"	W2	10 Clips

1/4"



Sockets, Ratchets & Attachments





17 Pieces – ⑥ Pt. Standard Metric Socket Set Set No. 221

Part No.	Description	Part No.	Description
20-04mm	4mm	20-12mm	12mm
20-05mm	5mm	20-13mm	13mm
20-5.5mm	5.5mm	20-14mm	14mm
20-06mm	6mm	2492	Ratchet
20-07mm	7mm	2402	2" Extension
20-08mm	8mm	2406	6" Extension
20-09mm	9mm	2441	Spinner
20-10mm	10mm	2475	Universal
20-11mm	11mm	12	Metal Box



23 Pieces – ⑥ Pt. Standard & Deep Metric Socket Set Set No. 224

Part No.	Description	Part No.	Description
6 Pt. Standard Metric Sockets			
20-05mm	5mm	20-10mm	10mm
20-06mm	6mm	20-11mm	11mm
20-07mm	7mm	20-12mm	12mm
20-08mm	8mm	20-13mm	13mm
20-09mm	9mm		
6 Pt. Deep Metric Sockets			
25-05mm	5mm	25-10mm	10mm
25-06mm	6mm	25-11mm	11mm
25-07mm	7mm	25-12mm	12mm
25-08mm	8mm	25-13mm	13mm
25-09mm	9mm		
Attachments			
2492	Ratchet	2441	Spinner
2402	2" Extension	2475	Universal
2406	6" Extension	13	Box



11 Pieces – ⑥ Pt. Standard Metric Socket Set Set No. 256

Part No.	Description	Part No.	Description
20-04mm	4mm	20-11mm	11mm
20-05mm	5mm	20-12mm	12mm
20-06mm	6mm	20-13mm	13mm
20-07mm	7mm	20-14mm	14mm
20-08mm	8mm	W108	Rail
20-09mm	9mm	W2	11 Clips
20-10mm	10mm		



1/4"



Sockets, Ratchets & Attachments





9 Pieces – ⑥ Pt. Deep Metric Socket Set Set No. 257

Part No.	Description	Part No.	Description
25-05mm	5mm	25-11mm	11mm
25-06mm	6mm	25-12mm	12mm
25-07mm	7mm	25-13mm	13mm
25-08mm	8mm	W108	Rail
25-09mm	9mm	W2	9 Clips
25-10mm	10mm		



11 Pieces – Hex Bit Socket Set Set No. 205

Part No.	Description	Part No.	Description
2202	1/16"	2210	3/16"
2203	5/64"	2212	7/32"
2204	3/32"	2214	1/4"
2205	7/64"	2218	5/16"
2206	1/8"	W008	Rail
2207	9/64"	W2	11 Clips
2208	5/32"		



5 Pieces – ⑫ Pt. Standard Universal Socket Set Set No. 207

Part No.	Description	Part No.	Description
2708	1/4"	2716	1/2"
2710	5/16"	W008	Rail
2712	3/8"	W2	5 Clips
2714	7/16"		

1/4"



Sockets, Ratchets & Attachments





Ratchets

- Wright ratchets are engineered to be both strong and compact. While 1/4" drive ratchets are generally used in low torque applications, Wright ratchets are actually at home in the world of high torque.
- Compact design – standard head 25/32" – heavy duty head 1-5/64".
- Precision machined 45 tooth action – works in the tightest places. One-piece kit is easily removed for inspection and lubrication.
- Contour handle for a comfortable grip.



2426



2492

Part No.	Description
2426	Ratchet – 45 teeth, 4-3/4" – Single Pawl, Swing arc 3/4"
2492*	Heavy Duty Ratchet – 45 Teeth, 5-1/4", Contour Handle (Head diameter only 1-5/64". Swing arc 1".)

*2492 ratchet is a single pawl, heavy-duty, round head ratchet that is superior in strength and durability.

Meets or exceeds ASME B107.110

Flex Head Ratchets

Head diameter only 25/32". Handle swings in 3/4" arc to get the next bite. Works in the tightest places. 45 teeth. Seven place indexing flex head.



2495

Part No.	Description
2495	Ratchet – 45 teeth - 5-1/2", Swing arc 3/4" (Contour Grip) Single Pawl

Meets or exceeds ASME B107.110

Black Industrial Finish Ratchet



32426

Part No.	Description
32426	1/4" Drive Ratchet, 4-3/4", Swing arc 3/4"

Meets or exceeds ASME B107.110

Renewal Kits

One piece, foolproof. Simply remove the snap ring and drop a new kit into place. On the spot repairs. Extends the life of the ratchet.



2401



2493

Part No.	Description
2401	1/4" Drive Ratchet Renewal Kit for 2426 and 2495
2493	Renewal Kit for 2492
32401	1/4" Drive Black Renewal Kit for 32426

NOTE: When cleaning your ratchet lubricate with light oil only.

1/4"



Sockets, Ratchets & Attachments





2435

Flex Handle

Like all Wright flex joints, the square is assembled with steel pin and tension washer. Smoother friction in joint, eliminating binding. Better chrome plating because parts are plated individually before assembly. Eliminates rust. Seven place indexing flex head.

Part No.	Description
2435	Flex Handle – 5"

2435 Flex Handle – 5"

Meets or exceeds ASME B107.110



Extensions

Part No.	Description	Part No.	Description
2402	2" Extension	2410	10" Extension
2404	4" Extension	2414	14" Extension
2406	6" Extension		

Meets or exceeds ASME B107.110



Spinner

Spinner handle with plastic grip.

Part No.	Description
2441	Spinner – 6" (not pictured)
2442	Spinner with female end - 6"

2441 Spinner – 6" (not pictured)
2442 Spinner with female end - 6"

Meets or exceeds ASME B107.110

1/4"



Sockets, Ratchets & Attachments





Adaptor

Part No.	Description	Length
2453	1/4" F x 3/8" M	1"

Meets or exceeds ASME B107.110



Locking Adaptor

Part No.	Description
2413	Set Screw – Locking Adaptor 1/4" F x 1/4" M, 1-11/16" Long

Meets or exceeds ASME B107.110



Speeder

Part No.	Description
2445	Speeder 14-1/2" long

Meets or exceeds ASME B107.110



Universal

Built-in spring tension for easy application to nut. No binding or locked joints; no sharp corners.

Part No.	Description
2475	Universal 1-5/16" long

Meets or exceeds ASME B107.110



1/4"



Sockets, Ratchets & Attachments





6 Pt. Standard Sockets

Part No.	Nom. Size	Shape	L	Ds	Dd	Bd
2005	5/32"	I	7/8"	17/64"	7/16"	5/32"
2006	3/16"	I	7/8"	19/64"	7/16"	3/32"
2007	7/32"	I	7/8"	11/32"	7/16"	7/64"
2008	1/4"	I	7/8"	23/64"	7/16"	1/8"
2009	9/32"	I	7/8"	13/32"	7/16"	9/64"
2010	5/16"	II	7/8"	15/32"	-	9/64"
2011	11/32"	II	7/8"	31/64"	-	5/32"
2012	3/8"	II	7/8"	17/32"	-	5/32"
2014	7/16"	II	7/8"	39/64"	-	7/32"
2016	1/2"	II	7/8"	43/64"	-	17/64"

Meets or exceeds ASME B107.110



6 Pt. Standard Metric Sockets

Part No.	Nom. Size	Shape	L	Ds	Dd	Bd
20-04mm	4mm	I	22.23	7.14	11.90	4.76
20-05mm	5mm	I	22.23	8.33	12.70	3.97
20-5.5mm	5.5mm	I	22.23	8.73	11.90	7.14
20-06mm	6mm	I	22.23	9.92	12.70	3.97
20-07mm	7mm	I	22.23	10.41	11.23	3.97
20-08mm	8mm	II	22.23	12.70	-	3.97
20-09mm	9mm	II	22.23	12.45	-	4.36
20-10mm	10mm	II	22.23	15.08	-	5.95
20-11mm	11mm	II	22.23	15.88	-	5.95
20-12mm	12mm	II	22.23	16.67	-	7.14
20-13mm	13mm	II	22.23	17.46	-	7.54
20-14mm	14mm	II	24.60	19.05	-	9.53

Meets or exceeds ASME B107.110



6 Pt. Deep Sockets

Part No.	Nom. Size	Shape	L	Ds	Dd	Bd
2506	3/16"	I	1-15/16"	5/16"	15/32"	3/16"
2507	7/32"	I	2"	11/32"	15/32"	7/64"
2508	1/4"	I	2"	3/8"	7/16"	1/8"
2509	9/32"	I	2"	13/32"	7/16"	9/64"
2510	5/16"	II	2"	7/16"	-	9/64"
2511	11/32"	II	2"	31/64"	-	5/32"
2512	3/8"	II	2"	17/32"	-	5/32"
2514	7/16"	II	2"	39/64"	-	7/32"
2516	1/2"	II	2"	43/64"	-	17/64"

Meets or exceeds ASME B107.110

Refer to socket dimensional drawings on page 112.

Wright Drive® 6 Pt. & 12 Pt. design sockets and combination wrenches give ten times more fastener contact area than conventional designs.





⑥ Pt. Deep Metric Sockets

Part No.	Nom. Size	Shape	L	Ds	Dd	Bd
25-04mm	4mm	I	50.30	7.14	11.90	2.38
25-05mm	5mm	I	50.30	8.33	12.70	5.55
25-06mm	6mm	I	50.30	9.53	12.70	6.35
25-07mm	7mm	I	50.80	10.41	11.23	10.32
25-08mm	8mm	II	50.80	12.70	—	10.32
25-09mm	9mm	II	50.80	12.45	—	11.51
25-10mm	10mm	II	50.80	14.68	—	13.10
25-11mm	11mm	II	50.80	15.86	—	13.89
25-12mm	12mm	II	50.80	16.67	—	15.06
25-13mm	13mm	II	50.80	18.25	—	17.86

Meets or exceeds ASME B107.110



⑧ Pt. Standard Sockets

Part No.	Nom. Size	Shape	L	Ds	Dd	Bd
2308	1/4"	II	15/16"	7/16"	—	1/8"
2310	5/16"	II	15/16"	9/16"	—	9/64"
2312	3/8"	II	15/16"	5/8"	—	5/32"

Meets or exceeds ASME B107.110



Wright Drive® 6 Pt. & 12 Pt. design sockets and combination wrenches give ten times more fastener contact area than conventional designs.

Shape I

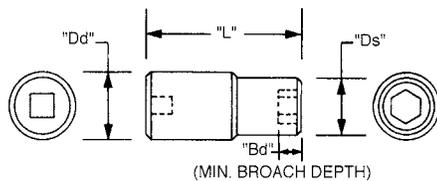

Shape II

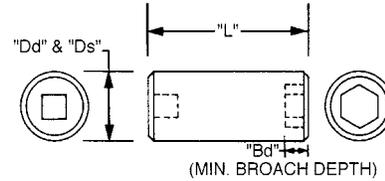



12 Pt. Standard Sockets

Part No.	Nom. Size	Shape	L	Ds	Dd	Bd
2106	3/16"	I	1"	15/16"	7/16"	3/32"
2107	7/32"	I	1"	11/32"	7/16"	7/64"
2108	1/4"	I	1"	3/8"	7/16"	1/8"
2109	9/32"	I	1"	7/16"	—	9/64"
2110	5/16"	II	1"	15/32"	—	9/64"
2111	11/32"	II	1"	1/2"	—	5/32"
2112	3/8"	II	1"	35/64"	—	5/32"
2114	7/16"	II	1"	39/64"	—	7/32"
2116	1/2"	II	1"	43/64"	—	17/64"
2118	9/16"	II	1"	3/4"	—	21/64"

Meets or exceeds ASME B107.110



12 Pt. Deep Sockets

Part No.	Nom. Size	Shape	L	Ds	Dd	Bd
2606	3/16"	I	2-1/32"	5/16"	7/16"	3/32"
2607	7/32"	I	2-1/32"	11/32"	7/16"	7/64"
2608	1/4"	I	2-1/32"	7/16"	—	3/16"
2609	9/32"	II	2-1/32"	15/32"	—	7/32"
2610	5/16"	II	2-1/32"	15/32"	—	7/32"
2611	11/32"	II	2-1/32"	1/2"	—	1/4"
2612	3/8"	II	2-1/32"	35/64"	—	1/4"
2614	7/16"	II	2-1/32"	39/64"	—	9/32"
2616	1/2"	II	2-1/32"	43/64"	—	5/16"
2618	9/16"	II	2-1/32"	3/4"	—	5/16"

Meets or exceeds ASME B107.110



12 Pt. Flex Sockets

Part No.	Nom. Size	Shape	L	Ds	Dd	Bd
2708	1/4"	III	1-7/32"	3/8"	1/2"	13/64"
2710	5/16"	III	1-5/16"	15/32"	1/2"	1/4"
2712	3/8"	III	1-3/8"	35/64"	1/2"	17/64"
2714	7/16"	III	1-7/16"	39/64"	1/2"	11/32"
2716	1/2"	III	1-15/32"	43/64"	1/2"	23/64"

Meets or exceeds ASME B107.110



Refer to socket dimensional drawings on page 114.

Wright Drive® 6 Pt. & 12 Pt. design sockets and combination wrenches give ten times more fastener contact area than conventional designs.





12 Pt. Standard Sockets

Black Industrial Finish

Part No.	Nom. Size	Shape	L	Ds	Dd	Bd
32106	3/16"	I	1"	5/16"	7/16"	3/32"
32107	7/32"	I	1"	11/32"	7/16"	7/64"
32108	1/4"	I	1"	3/8"	7/16"	1/8"
32109	9/32"	I	1"	7/16"	—	9/64"
32110	5/16"	II	1"	15/32"	—	9/64"
32111	11/32"	II	1"	1/2"	—	5/32"
32112	3/8"	II	1"	35/64"	—	5/32"
32114	7/16"	II	1"	39/64"	—	7/32"
32116	1/2"	II	1"	43/64"	—	17/64"
32118	9/16"	II	1"	3/4"	—	21/64"



For Hand Use Only
Meets or exceeds ASME B107.110

12 Pt. Deep Sockets

Black Industrial Finish

Part No.	Nom. Size	Shape	L	Ds	Dd	Bd
32606	3/16"	I	2-1/32"	5/16"	7/16"	3/32"
32607	7/32"	I	2-1/32"	11/32"	7/16"	7/64"
32608	1/4"	I	2-1/32"	3/8"	7/16"	3/16"
32609	9/32"	II	2-1/32"	7/16"	—	7/32"
32610	5/16"	II	2-1/32"	15/32"	—	7/32"
32611	11/32"	II	2-1/32"	1/2"	—	1/4"
32612	3/8"	II	2-1/32"	35/64"	—	1/4"
32614	7/16"	II	2-1/32"	39/64"	—	9/32"
32616	1/2"	II	2-1/32"	43/64"	—	5/16"
32618	9/16"	II	2-1/32"	3/4"	—	5/16"



For Hand Use Only
Meets or exceeds ASME B107.110

Wright Drive® 6 Pt. & 12 Pt. design sockets and combination wrenches give ten times more fastener contact area than conventional designs.

Shape I

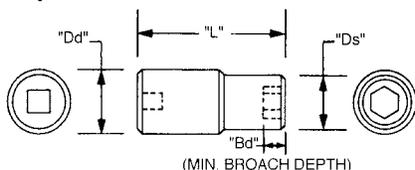

Shape II

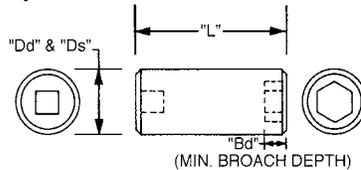

Shape III

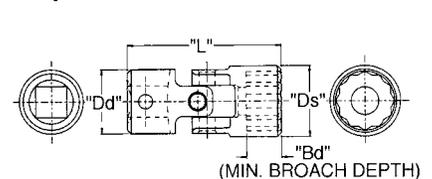

1/4" Sockets, Ratchets & Attachments



Replacement Hex Bit

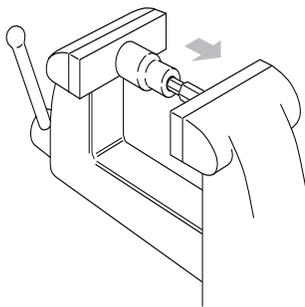

The design allows easy replacement of a broken bit. After driving out the remaining piece, simply press the new bit in using a bench vise.

Nominal Bit Size

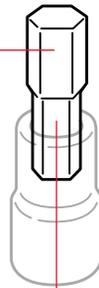

Shank

Hex Bit Sockets and Replacement Hex Bits

Part No.	Nom. Size	Socket Dia.	Overall Length	Replacement Bit Part No.	Bit Length
2202	1/16"	1/2"	1-15/16"	2202B	1-9/16"
2203	5/64"	1/2"	1-15/16"	2203B	1-5/16"
2204	3/32"	1/2"	1-15/16"	2204B	1-5/16"
2205	7/64"	1/2"	1-15/16"	2205B	1-5/16"
2206	1/8"	1/2"	1-15/16"	2206B	1-23/64"
2207	9/64"	1/2"	1-15/16"	2207B	1-21/64"
2208	5/32"	1/2"	1-15/16"	2208B	1-11/32"
2210	3/16"	1/2"	1-15/16"	2210B	1-11/32"
2212	7/32"	1/2"	1-15/16"	2212B	1-21/64"
2214	1/4"	1/2"	1-15/16"	2214B	1-11/32"
2218	5/16"	1/2"	2-1/16"	3210B	1-29/64"

Meets or exceeds ASME B107.110

1/4"



Sockets, Ratchets & Attachments



Replacement Screwdriver Bit

Standard Screwdriver Sockets with Bits and Replacement Bits

Part No.	Nom. Size	Socket Dia.	Overall Length	Replacement Bit Part No.	Bit Length
2260	3/16"	1/2"	1-5/8"	2260B	1"
2261	1/4"	1/2"	1-5/8"	2261B	1"
2263	23/64"	1/2"	1-5/8"	2263B	1"

Meets or exceeds ASME B107.110





**Phillips Screwdriver Sockets
 with Bits and Replacement Bits**

Part No.	Nom. Size	Overall Length	Replacement Bit Part No.	Bit Length
2265	#1	1-5/8"	2265B	1"
2266	#2	1-5/8"	2266B	1"

Meets or exceeds ASME B107.110



Replacement Phillips
 Screwdriver Bit

**Long Phillips Screwdriver Sockets
 with Bits and Replacement Bits**

Part No.	Nom. Size	Overall Length	Replacement Bit Part No.	Bit Length
2267	#1	2-1/8"	2267B	2"
9203	#2	2-5/8"	2268B	2"

Meets or exceeds ASME B107.110



Replacement Long Phillips
 Screwdriver Bit

1/4"



Sockets, Ratchets & Attachments





Torx Sockets

Part No.	Dr. Sq. Size	Shape	Head Size	L	Ds	Dd
9250	1/4"	I	E-6	1-1/16"	5/16"	1/2"
9251	1/4"	I	E-7	1-1/16"	3/8"	1/2"
9252	1/4"	I	E-8	1-1/16"	13/32"	1/2"

Meets or exceeds ASME B107.110



Torx Bits

Part No.	Hex Size	Shape	Bit Size	L
9271	1/4"	II	T-8	1"
9272	1/4"	II	T-10	1"
9273	1/4"	II	T-15	1"
9274	1/4"	II	T-20	1"
9275	1/4"	II	T-25	1"
9276	1/4"	II	T-27	1"
9277	1/4"	II	T-30	1"

Meets or exceeds ASME B107.110



Bit Holders

Part No.	Dr. Sq. Size	Shape	Head Size	L	Ds	Dd
9280	1/4"	III	1/4"	1"	1/2"	1/2"

Meets or exceeds ASME B107.110

Shape I

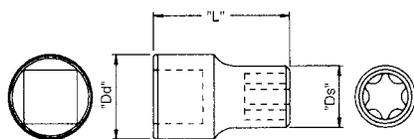

Shape II

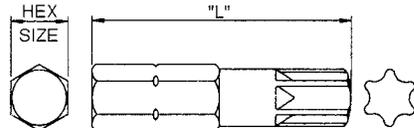

Shape III

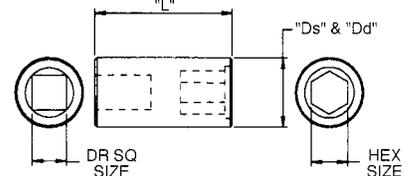



56 Pieces – 12 Pt. Standard Socket, 6 & 12 Pt. Deep Socket, 12 Pt. Flex Socket, 8 Pt. Standard Socket, Hex Bit Socket, & Phillips & Standard Screwdriver Socket with Bit Set Set No. 348

Part No.	Description	Part No.	Description
12 Pt. Standard Sockets			
3108	1/4"	3122	11/16"
3110	5/16"	3124	3/4"
3112	3/8"	3126	13/16"
3114	7/16"	3128	7/8"
3116	1/2"	3130	15/16"
3118	9/16"	3132	1"
3120	5/8"		
6 Pt. Deep Sockets			
3508	1/4"	3510	5/16"
12 Pt. Deep Sockets			
3612	3/8"	3624	3/4"
3614	7/16"	3626	13/16"
3616	1/2"	3628	7/8"
3618	9/16"	3630	15/16"
3620	5/8"	3632	1"
3622	11/16"		
12 Pt. Flex Sockets			
3712	3/8"	3720	5/8"
3714	7/16"	3722	11/16"
3716	1/2"	3724	3/4"
3718	9/16"		
8 Pt. Standard Sockets			
3308	1/4"	3314	7/16"
3310	5/16"	3316	1/2"
3312	3/8"		
Hex Bit Sockets			
3204	1/8"	3208	1/4"
3205	5/32"	3210	5/16"
3206	3/16"	3212	3/8"
3207	7/32"		
Phillips Screwdriver Socket with Bit			
3266	#2	3268	#4
3267	#3		
Standard Screwdriver Socket with Bit			
3260	1/4"		
Attachments			
3426	Ratchet	3435	Flex Handle
3403	3" Extension	3475	Universal
3405	5" Extension	3443	Sliding T
3412	12" Extension	WT528	Metal Box



3/8"



Sockets, Ratchets & Attachments





32 Pieces – 12 Pt. Standard & Deep Socket, 8 Pt. Standard Socket & 12 Pt. Flex Sockets Set No. 346

Part No.	Description	Part No.	Description
12 Pt. Standard Sockets			
3112	3/8"	3122	11/16"
3114	7/16"	3124	3/4"
3116	1/2"	3126	13/16"
3118	9/16"	3128	7/8"
3120	5/8"		
12 Pt. Deep Sockets			
3612	3/8"	3622	11/16"
3614	7/16"	3624	3/4"
3616	1/2"	3626	13/16"
3618	9/16"	3628	7/8"
3620	5/8"		
8 Pt. Standard Sockets			
3308	1/4"	3312	3/8"
3310	5/16"		
12 Pt. Flex Sockets			
3714	7/16"	3720	5/8"
3716	1/2"	3724	3/4"
3718	9/16"		
Attachments			
3426	Ratchet	3412	12" Extension
3403	3" Extension	3435	Flex Handle
3405	5" Extension	3475	Universal
98	Metal Box		



31 Pieces – 6 Pt. Standard & Deep Socket Set Set No. 339

Part No.	Description	Part No.	Description
6 Pt. Standard Sockets			
3008	1/4"	3022	11/16"
3010	5/16"	3024	3/4"
3012	3/8"	3026	13/16"
3014	7/16"	3028	7/8"
3016	1/2"	3030	15/16"
3018	9/16"	3032	1"
3020	5/8"		
6 Pt. Deep Sockets			
3508	1/4"	3522	11/16"
3510	5/16"	3524	3/4"
3512	3/8"	3526	13/16"
3514	7/16"	3528	7/8"
3516	1/2"	3530	15/16"
3518	9/16"	3532	1"
3520	5/8"		
Attachments			
3426	Ratchet	3435	Flex Handle
3403	3" Extension	3475	Universal
3405	5" Extension	98	Metal Box

3/8"



Sockets, Ratchets & Attachments





29 Pieces – 12 Pt. Standard & Deep Socket Set Set No. 340

Part No.	Description	Part No.	Description
12 Pt. Standard Sockets			
3108	1/4"	3122	11/16"
3110	5/16"	3124	3/4"
3112	3/8"	3126	13/16"
3114	7/16"	3128	7/8"
3116	1/2"	3130	15/16"
3118	9/16"	3132	1"
3120	5/8"		
12 Pt. Deep Sockets			
3612	3/8"	3624	3/4"
3614	7/16"	3626	13/16"
3616	1/2"	3628	7/8"
3618	9/16"	3630	15/16"
3620	5/8"	3632	1"
3622	11/16"		
Attachments			
3426	Ratchet	3435	Flex Handle
3403	3" Extension	3475	Universal
3405	5" Extension	98	Metal Box



21 Pieces – 6 Pt. Standard & Deep Socket Set Set No. 337

Part No.	Description	Part No.	Description
6 Pt. Standard Sockets			
3012	3/8"	3022	11/16"
3014	7/16"	3024	3/4"
3016	1/2"	3026	13/16"
3018	9/16"	3028	7/8"
3020	5/8"		
6 Pt. Deep Sockets			
3512	3/8"	3522	11/16"
3514	7/16"	3524	3/4"
3516	1/2"	3526	13/16"
3518	9/16"	3528	7/8"
3520	5/8"		
Attachments			
3426	Ratchet	3435	Flex Handle
3405	5" Extension	W416	Metal Box



3/8"



Sockets, Ratchets & Attachments





21 Pieces – 12 Pt. Standard & Deep Socket Set Set No. 338

Part No.	Description	Part No.	Description
12 Pt. Standard Sockets			
3112	3/8"	3122	11/16"
3114	7/16"	3124	3/4"
3116	1/2"	3126	13/16"
3118	9/16"	3128	7/8"
3120	5/8"		
12 Pt. Deep Sockets			
3612	3/8"	3622	11/16"
3614	7/16"	3624	3/4"
3616	1/2"	3626	13/16"
3618	9/16"	3628	7/8"
3620	5/8"		
Attachments			
3426	Ratchet	3435	Flex Handle
3405	5" Extension	W416	Metal Box



14 Pieces – 12 Pt. Standard Socket Set Set No. 334

Part No.	Description	Part No.	Description
3112	3/8"	3128	7/8"
3114	7/16"	3426	Ratchet, Knurled Grip
3116	1/2"	3403	3" Extension
3118	9/16"	3412	12" Extension
3120	5/8"	3435	Flex Handle
3122	11/16"	3475	Universal
3124	3/4"	W417	Metal Box
3126	13/16"		



14 Pieces – 6 Pt. Standard Socket Set Set No. 335

Part No.	Description	Part No.	Description
3012	3/8"	3028	7/8"
3014	7/16"	3426	Ratchet
3016	1/2"	3403	3" Extension
3018	9/16"	3405	5" Extension
3020	5/8"	3435	Flex Handle
3022	11/16"	3475	Universal
3024	3/4"	W408	Metal Box
3026	13/16"		

3/8"



Sockets, Ratchets & Attachments





**13 Pieces – ⑥ Pt. Standard Socket Set
 Set No. 329**

Part No.	Description	Part No.	Description
3012	3/8"	3026	13/16"
3014	7/16"	3028	7/8"
3016	1/2"	3426	Ratchet
3018	9/16"	3405	5" Extension
3020	5/8"	3435	Flex Handle
3022	11/16"	3475	Universal
3024	3/4"	W408	Metal Box



**13 Pieces – ⑫ Pt. Standard Socket Set
 Set No. 330**

Part No.	Description	Part No.	Description
3112	3/8"	3126	13/16"
3114	7/16"	3128	7/8"
3116	1/2"	3426	Ratchet
3118	9/16"	3405	5" Extension
3120	5/8"	3435	Flex Handle
3122	11/16"	3475	Universal
3124	3/4"	W408	Metal Box



**11 Pieces – ⑥ Pt. Standard Socket Set
 Set No. 327**

Part No.	Description	Part No.	Description
3012	3/8"	3024	3/4"
3014	7/16"	3026	13/16"
3016	1/2"	3028	7/8"
3018	9/16"	3426	Ratchet
3020	5/8"	3405	5" Extension
3022	11/16"	W408	Metal Box



3/8"



Sockets, Ratchets & Attachments





11 Pieces – 12 Pt. Standard Socket Set Set No. 328

Part No.	Description	Part No.	Description
3112	3/8"	3124	3/4"
3114	7/16"	3126	13/16"
3116	1/2"	3128	7/8"
3118	9/16"	3426	Ratchet
3120	5/8"	3405	5" Extension
3122	11/16"	W408	Metal Box



11 Pieces – 6 Pt. Standard Socket Set Set No. 312

Part No.	Description	Part No.	Description
3008	1/4"	3022	11/16"
3010	5/16"	3024	3/4"
3012	3/8"	3026	13/16"
3014	7/16"	3028	7/8"
3016	1/2"	W010	Rail
3018	9/16"	W3	11 Clips
3020	5/8"		



9 Pieces – 6 Pt. Deep Socket Set Set No. 304

Part No.	Description	Part No.	Description
3512	3/8"	3524	3/4"
3514	7/16"	3526	13/16"
3516	1/2"	3528	7/8"
3518	9/16"	W010	Rail
3520	5/8"	W3	9 Clips
3522	11/16"		

3/8"



Sockets, Ratchets & Attachments





**10 Pieces – 12 Pt. Standard Socket Set
 Set No. 378**

Part No.	Description	Part No.	Description
3110	5/16"	3122	11/16"
3112	3/8"	3124	3/4"
3114	7/16"	3126	13/16"
3116	1/2"	3128	7/8"
3118	9/16"	W010	Rail
3120	5/8"	W3	10 Clips



**9 Pieces – 12 Pt. Deep Socket Set
 Set No. 300**

Part No.	Description	Part No.	Description
3612	3/8"	3624	3/4"
3614	7/16"	3626	13/16"
3616	1/2"	3628	7/8"
3618	9/16"	W010	Rail
3620	5/8"	W3	9 Clips
3622	11/16"		



**11 Pieces – 8 Pt. Standard Socket Set
 Set No. 379**

Part No.	Description	Part No.	Description
3308	1/4"	3322	11/16"
3310	5/16"	3324	3/4"
3312	3/8"	3326	13/16"
3314	7/16"	3328	7/8"
3316	1/2"	W010	Rail
3318	9/16"	W3	11 Clips
3320	5/8"		



3/8"



Sockets, Ratchets & Attachments





7 Pieces – Hex Bit Socket Set Set No. 305

Part No.	Description	Part No.	Description
3204	1/8"	3208	1/4"
3205	5/32"	3210	5/16"
3206	3/16"	3212	3/8"
3207	7/32"	225	Plastic Box



10 Pieces – 3/8" & 1/2" Drive Hex Bit Socket Set Set No. 311

Part No.	Description	Part No.	Description
3/8" Drive Hex Bit Sockets			
3204	1/8"	3208	1/4"
3205	5/32"	3210	5/16"
3206	3/16"	3212	3/8"
3207	7/32"		
1/2" Drive Hex Bit Sockets			
4216	1/2"	4220	5/8"
4218	9/16"	226	Plastic Box



7 Piece – Long Length Hex Bit Socket Set Set No. 316

Part No.	Description	Part No.	Description
32L04	1/8"	32L08	1/4"
32L05	5/32"	32L10	5/16"
32L06	3/16"	32L12	3/8"
32L07	7/32"	W008	Rail
		W3	7 Clips

3/8"



Sockets, Ratchets & Attachments





**7 Pieces – 12 Pt. Flex Socket Set
 Set No. 308**

Part No.	Description	Part No.	Description
3712	3/8"	3722	11/16"
3714	7/16"	3724	3/4"
3716	1/2"	W008	Rail
3718	9/16"	W3	7 Clips
3720	5/8"		



**5 Pieces – Screwdriver Socket Set
 Set No. 306**

Part No.	Description	Part No.	Description
3266	Phillips No. 2	3260	1/4" Blade
3267	Phillips No. 3	3262	3/8" Blade
3268	Phillips No. 4	97	Metal Box



3/8"



Sockets, Ratchets & Attachments



3/8" Drive Crowfoot Wrench Sets

WRIGHT TOOL
PERFECTING PERFORMANCE



10 Pieces – Crowfoot Wrench Set Set No. 700

Part No.	Description	Part No.	Description
1012	3/8"	1024	3/4"
1014	7/16"	1026	13/16"
1016	1/2"	1028	7/8"
1018	9/16"	1032	1"
1020	5/8"	W010	Rail
1022	11/16"	W3	10 Clips



10 Pieces – Metric Crowfoot Wrench Set Set No. 701

Part No.	Description	Part No.	Description
10-10mm	10mm	10-16mm	16mm
10-11mm	11mm	10-17mm	17mm
10-12mm	12mm	10-18mm	18mm
10-13mm	13mm	10-19mm	19mm
10-14mm	14mm	W110	Rail
10-15mm	15mm	W3	10 Clips



8 Pieces – Flare Nut ¹²Pt. Crowfoot Wrench Set Set No. 702

Part No.	Description	Part No.	Description
1060	5/8"	1070	15/16"
1062	11/16"	1072	1"
1064	3/4"	1074	1-1/16"
1066	13/16"	W010	Rail
1068	7/8"	W3	8 Clips

3/8"



Sockets, Ratchets & Attachments





27 Pieces – ⑥ Pt. Standard & Deep Metric Socket Set Set No. 377

Part No.	Description	Part No.	Description
6 Pt. Standard Metric Sockets			
30-06mm	6mm	30-13mm	13mm
30-07mm	7mm	30-14mm	14mm
30-08mm	8mm	30-15mm	15mm
30-09mm	9mm	30-16mm	16mm
30-10mm	10mm	30-17mm	17mm
30-11mm	11mm	30-18mm	18mm
30-12mm	12mm </td <td>30-19mm</td> <td>19mm</td>	30-19mm	19mm
6 Pt. Deep Metric Sockets			
35-10mm	10mm	35-15mm	15mm
35-11mm	11mm	35-16mm	16mm
35-12mm	12mm	35-17mm	17mm
35-13mm	13mm	35-18mm	18mm
35-14mm	14mm	35-19mm	19mm
Attachments			
3426	Ratchet	3435	Flex Handle
3405	5" Extension	W316	Metal Box



19 Pieces – ⑥ & ⑫ Pt. Standard Metric Socket Set Set No. 364

Part No.	Description	Part No.	Description
6 Pt. Standard Metric Sockets			
30-06mm	6mm	30-07mm	7mm
12 Pt. Standard Metric Sockets			
31-08mm	8mm	31-14mm	14mm
31-09mm	9mm	31-15mm	15mm
31-10mm	10mm	31-16mm	16mm
31-11mm	11mm	31-17mm	17mm
31-12mm	12mm	31-18mm	18mm
31-13mm	13mm	31-19mm	19mm
Attachments			
3426	Ratchet	3435	Flex Handle
3403	3" Extension	3475	Universal
3412	12" Extension	W417	Metal Box



3/8"



Sockets, Ratchets & Attachments





17 Pieces – 6 Pt. Standard Metric Socket Set Set No. 366

Part No.	Description	Part No.	Description
30-06mm	6mm	30-15mm	15mm
30-07mm	7mm	30-16mm	16mm
30-08mm	8mm	30-17mm	17mm
30-09mm	9mm	30-18mm	18mm
30-10mm	10mm	30-19mm	19mm
30-11mm	11mm	3426	Ratchet
30-12mm	12mm	3405	5" Extension
30-13mm	13mm	3435	Flex Handle
30-14mm	14mm	W409	Metal Box



14 Pieces – 6 Pt. Standard Metric Socket Set Set No. 367

Part No.	Description	Part No.	Description
30-06mm	6mm	30-14mm	14mm
30-07mm	7mm	30-15mm	15mm
30-08mm	8mm	30-16mm	16mm
30-09mm	9mm	30-17mm	17mm
30-10mm	10mm	3426	Ratchet
30-11mm	11mm	3403	3" Extension
30-12mm	12mm	W409	Metal Box
30-13mm	13mm		



12 Pieces – 12 Pt. Standard Metric Socket Set Set No. 349

Part No.	Description	Part No.	Description
31-08mm	8mm	31-15mm	15mm
31-09mm	9mm	31-16mm	16mm
31-10mm	10mm	31-17mm	17mm
31-11mm	11mm	31-18mm	18mm
31-12mm	12mm	31-19mm	19mm
31-13mm	13mm	W110	Rail
31-14mm	14mm	W3	12 Clips

3/8" Sockets, Ratchets & Attachments





**14 Pieces – ⑥ Pt. Standard Metric
 Socket Set
 Set No. 354**

Part No.	Description	Part No.	Description
30-06mm	6mm	30-14mm	14mm
30-07mm	7mm	30-15mm	15mm
30-08mm	8mm	30-16mm	16mm
30-09mm	9mm	30-17mm	17mm
30-10mm	10mm	30-18mm	18mm
30-11mm	11mm	30-19mm	19mm
30-12mm	12mm	W110	Rail
30-13mm	13mm	W3	14 Clips

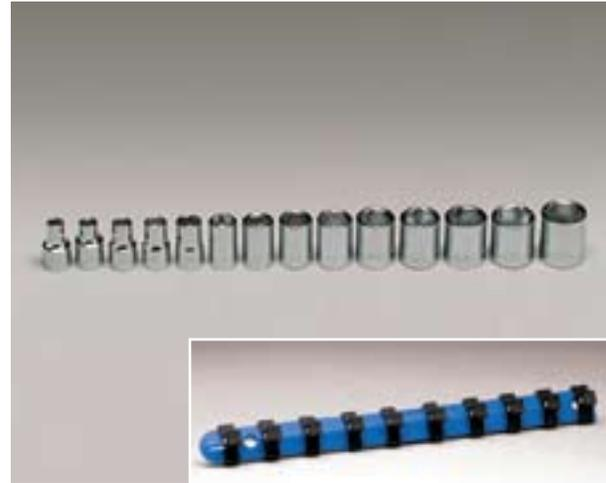

**14 Pieces – ⑥ Pt. Deep Metric
 Socket Set
 Set No. 355**

Part No.	Description	Part No.	Description
35-06mm	6mm	35-14mm	14mm
35-07mm	7mm	35-15mm	15mm
35-08mm	8mm	35-16mm	16mm
35-09mm	9mm	35-17mm	17mm
35-10mm	10mm	35-18mm	18mm
35-11mm	11mm	35-19mm	19mm
35-12mm	12mm	W110	Rail
35-13mm	13mm	W3	14 Clips



**8 Pieces – Hex Bit Metric
 Socket Set
 Set No. 353**

Part No.	Description	Part No.	Description
32-02mm	2mm	32-06mm	6mm
32-02.5mm	2.5mm	32-08mm	8mm
32-03mm	3mm	32-10mm	10mm
32-04mm	4mm	227	Plastic Box
32-05mm	5mm		



3/8"



Sockets, Ratchets & Attachments





9 Pieces – 3/8" & 1/2" Drive Hex Bit Metric Socket Set Set No. 360

Part No.	Description	Part No.	Description
32-04mm	4mm	32-10mm	10mm
32-05mm	5mm	42-12mm	12mm
32-06mm	6mm	42-14mm	14mm
32-07mm	7mm	42-17mm	17mm
32-08mm	8mm	228	Plastic Box



5 Piece – Long Length Metric Hex Bit Socket Set Set No. 361

Part No.	Description	Part No.	Description
32L-04mm	4mm	32L10mm	10mm
32L-05mm	5mm	WT108	Rail
32L-06mm	6mm	W3	5 Clips
32L-08mm	8mm		



8 Pieces – 6 Pt. Standard Impact Socket Set Set No. 313

Part No.	Description	Part No.	Description
3810	5/16"	3820	5/8"
3812	3/8"	3822	11/16"
3814	7/16"	3824	3/4"
3816	1/2"	W008	Rail
3818	9/16"	W3	8 Clips

3/8"



Sockets, Ratchets & Attachments





**8 Pieces – 6 Pt. Deep Impact
 Socket Set
 Set No. 314**

Part No.	Description	Part No.	Description
3910	5/16"	3920	5/8"
3912	3/8"	3922	11/16"
3914	7/16"	3924	3/4"
3916	1/2"	W008	Rail
3918	9/16"	W3	8 Clips



3/8"



**7 Pieces – Impact Hex-Bit
 Socket Set
 Set No. 362**

Part No.	Description	Part No.	Description
32B04	1/8"	32B10	5/16"
32B05	5/32"	32B12	3/8"
32B06	3/16"	W008	Rail
32B07	7/32"	W3	7 Clips
32B08	1/4"		



Sockets, Ratchets & Attachments





7 Pieces – 6 Pt. Standard Universal Power Socket Set Set No. 332

Part No.	Description	Part No.	Description
3852	3/8"	3862	11/16"
3854	7/16"	3864	3/4"
3856	1/2"	W008	Rail
3858	9/16"	W3	7 Clips
3860	5/8"		



7 Pieces – 6 Pt. Deep Universal Power Socket Set Set No. 333

Part No.	Description	Part No.	Description
3952	3/8"	3962	11/16"
3954	7/16"	3964	3/4"
3956	1/2"	W008	Rail
3958	9/16"	W3	7 Clips
3960	5/8"		

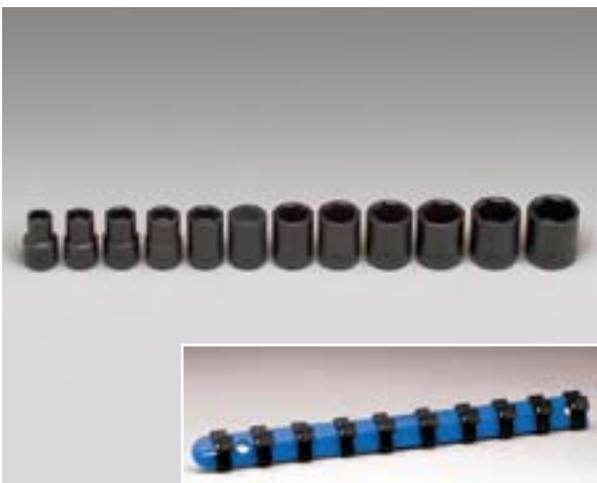

12 Pieces – 6 Pt. Standard Impact Metric Socket Set Set No. 356

Part No.	Description	Part No.	Description
38-08mm	8mm	38-15mm	15mm
38-09mm	9mm	38-16mm	16mm
38-10mm	10mm	38-17mm	17mm
38-11mm	11mm	38-18mm	18mm
38-12mm	12mm	38-19mm	19mm
38-13mm	13mm	W110	Rail
38-14mm	14mm	W3	12 Clips

3/8"



Sockets, Ratchets & Attachments





**9 Pieces – Metric Impact Hex-Bit Socket Set
 Set No. 363**

Part No.	Description	Part No.	Description
32B-02mm	2mm	32B-07mm	7mm
32B-02.5mm	2.5mm	32B-08mm	8mm
32B-03mm	3mm	32B-10mm	10mm
32B-04mm	4mm	W108	Rail
32B-05mm	5mm	W3	9 Clips
32B-06mm	6mm		



**5 Pieces – 6 Pt. Standard Metric Universal Power Socket Set
 Set No. 351**

Part No.	Description	Part No.	Description
38-50mm	10mm	38-55mm	15mm
38-52mm	12mm	W108	Rail
38-53mm	13mm	W3	5 Clips
38-54mm	14mm		



**12 Pieces – 6 Pt. Deep Impact Metric Socket Set
 Set No. 357**

Part No.	Description	Part No.	Description
39-08mm	8mm	39-15mm	15mm
39-09mm	9mm	39-16mm	16mm
39-10mm	10mm	39-17mm	17mm
39-11mm	11mm	39-18mm	18mm
39-12mm	12mm	39-19mm	19mm
39-13mm	13mm	W110	Rail
39-14mm	14mm	W3	12 Clips



3/8"



Sockets, Ratchets & Attachments





14 Pieces – 6 Pt. Standard Impact Metric Socket Set Set No. 359

Part No.	Description	Part No.	Description
38-06mm	6mm	38-14mm	14mm
38-07mm	7mm	38-15mm	15mm
38-08mm	8mm	38-16mm	16mm
38-09mm	9mm	38-17mm	17mm
38-10mm	10mm	38-18mm	18mm
38-11mm	11mm	38-19mm	19mm
38-12mm	12mm	W113	Rail
38-13mm	13mm	W3	14 Clips

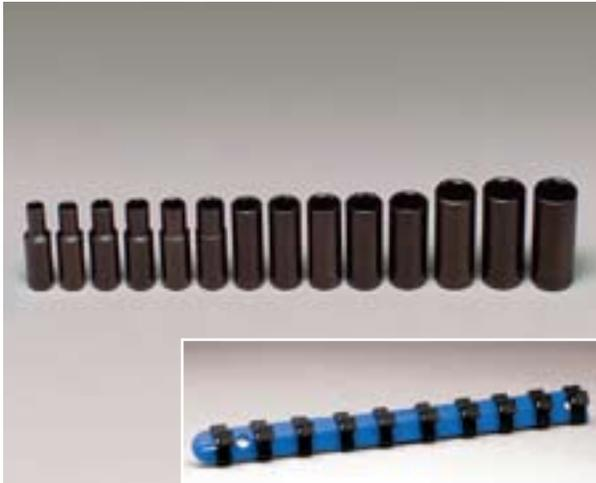

14 Pieces – 6 Pt. Deep Impact Metric Socket Set Set No. 358

Part No.	Description	Part No.	Description
39-06mm	6mm	39-14mm	14mm
39-07mm	7mm	39-15mm	15mm
39-08mm	8mm	39-16mm	16mm
39-09mm	9mm	39-17mm	17mm
39-10mm	10mm	39-18mm	18mm
39-11mm	11mm	39-19mm	19mm
39-12mm	12mm	W113	Rail
39-13mm	13mm	W3	14 Clips



10 Pieces – 6 Pt. Deep Impact Metric Universal Socket Set Set No. 352

Part No.	Description	Part No.	Description
39-50mm	10mm	39-56mm	16mm
39-51mm	11mm	39-57mm	17mm
39-52mm	12mm	39-58mm	18mm
39-53mm	13mm	39-59mm	19mm
39-54mm	14mm	W113	Rail
39-55mm	15mm	W3	10 Clips

3/8"



Sockets, Ratchets & Attachments





Ratchets

Two Head Styles – Round and Pear Shape

• **Round** – Our standard round head handles have 41 precision machined teeth. The double pawl kits used in all handles (Comfort Grip – Nitrile and Contour design steel) gives exceptionally long life. Allowing the 41 teeth to operate as an 82 tooth action and a 4-1/2° arc swing, while retaining the longer wearing characteristics of 41 teeth.

• **Pear** – One-Piece Drop forging – two moving parts, contour handle, built-in spinner. Our pear-shaped ratchet is a compact open-head design with contour steel handle. The heavy 30 tooth knurl acts as a spinner, and is easily cleanable in high dirt situations. The unique design also allows for special application.



3400



3426



3425



3427



3428



3429



3440



3433



3430



33430



3480



3482



3490



33426

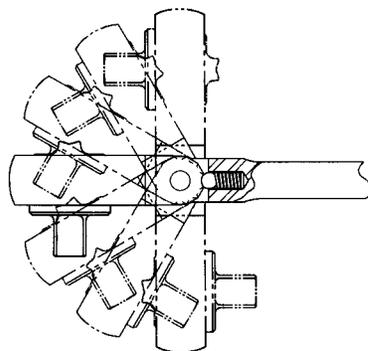

Seven Place Indexing
Flex Head
3427, 3428, 3429, 3440

3/8"



Sockets, Ratchets & Attachments





Part No.	Description	Length Overall	Swing Arc	No. of Teeth	Head Dia.	Renewal Kit No.
3400	Nitrile Comfort Grip—Double Pawl	7-1/32"	1-1/4"	41	1-1/4"	3491
3425	Long Contour Handle—Double Pawl	10"	1-3/4"	41	1-1/4"	3491
3426	Knurled Grip—Double Pawl	7"	1-1/4"	41	1-1/4"	3491
3427	Knurled Grip, Flex Head—Double Pawl	9-11/16"	1-1/2"	41	1-1/4"	3491
3428	Nitrile Comfort Grip, Flex Head—Double Pawl	10-3/4"	1-3/4"	41	1-1/4"	3491
3429	Nitrile Comfort Grip, Bent Flex Head Ergonomic Double Offset—Double Pawl	10-3/4"	1-3/4"	41	1-1/4"	3491
3430	Compact—Palm Size for Low Torque Application—Single Pawl	4-3/4"	3/4"	45	27/32"	3432
3433	Knurled Handle, Raised Cap, Lineman's Ratchet—Double Pawl	7"	1-1/4"	41	1-1/4"	3434
3440	Compact—Palm Size Flex Head for Low Torque Application—Single Pawl	5-1/2"	1"	45	27/32"	3432
3480	Pear-Shaped Open Head—Single Pawl	7-7/8"	2-1/4"	30	1-1/8"	3481
3482	Pear-Shaped Open Head Combination 3/8" and 1/4" Drives (crew chief ratchet)	7-7/8"	2-1/4"	30	1-1/8"	3483
3490	Contour Handle—Double Pawl	7-1/32"	1-1/4"	41	1-1/4"	3491
33426	Black Knurled Grip—Double Pawl	7"	1-1/4"	41	1-1/4"	3491
33430	Black Compact Contour Grip—Single Pawl	4-3/4"	3/4"	45	27/32"	3432

Double Pawl allows 41 teeth to operate with 82 tooth action and a 4-1/2° arc swing.

Meets or exceeds ASME B107.110

Wright Tool gives you several handle and head styles to fit the toughest job application. Drop forged from 4140 chrome molly steel, our smallest ratchet, at 4-3/4" to our longest at 11", we have a ratchet to fit your needs.

Renewal Kits

Simple one-piece construction. Makes cleaning or repair simple. Clean and lubricate with light oil only.

Part No.	Description
33491	For 33426
3432	For 3430, 3440, 33430 Ratchets
3481	For 3480 Ratchet
3483	For 3482 Ratchet
3491	For 3400, 3425, 3426, 3427, 3428, 3429, 3490, Ratchets (Double Pawl)
3434	For 3433

NOTE: When cleaning your ratchet lubricate with light oil only.

Premium Double Pawl

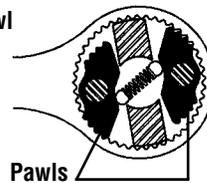

3/8" Sockets, Ratchets & Attachments





Ratchet Spinner

One piece. Easy to use.

Part No. Description

3431 For all 3/8" Drive Ratchets – 1-1/4" Length

Meets or exceeds ASME B107.110



Flex Handles

Steel pin and tension washer construction for extra strength. No binding or locked joints.

Part No.	Overall Description	Length
3435	Knurled Steel Handle	8-15/32"
33435	Black Knurled Steel Handle	8-15/32"
3438	Nitrile Handle	9-11/16"
3439	Contour Handle	10-3/4"

Meets or exceeds ASME B107.110

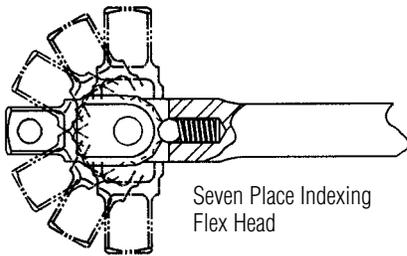

3435



33435



3438



3439



Mechanics who are known by the quality of their tools appreciate the quality of *wright tools!*





Extensions

Part No.	Description
3402	1-1/2"
3403	3"
3405	6"
3408	8"
3412	12"
3424	24"
3422	34" Extra Long

Meets or exceeds ASME B107.110

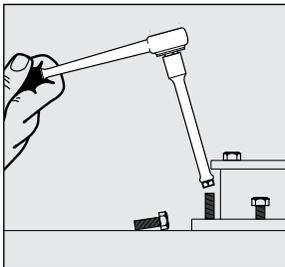

Wobble Extensions

Part No.	Description
3409	1-1/2"
3410	3"
3411	6"

Meets or exceeds ASME B107.110



Sliding T

Head held in place by friction ball—allows easy movement to ends of bar with no overhang. Works in tighter places.

Part No.	Description
3443	Sliding T – 7"

Meets or exceeds ASME B107.110

3/8"



Sockets, Ratchets & Attachments





Adaptors

Permits interchange of handles, sockets, and drive tools from one size to another. Not replaced if square ends are twisted off.

Part No.	Description	Length
3452	3/8" F x 1/4" M	1-1/16"
3454	3/8" F x 1/2" M	1-3/8"

Meets or exceeds ASME B107.110



3452



3454

Locking Adaptor

Part No.	Description
3413	Set screw – locking adaptor 3/8" F x 3/8" M, 2-1/16" long

Meets or exceeds ASME B107.110



Speeder

Part No.	Description
3445	Speeder 14-1/2" long

Meets or exceeds ASME B107.110



3/8"



Sockets, Ratchets & Attachments





Universal

Built-in spring tension for easy application to the nut. No binding or locked joints. No sharp corners.

Part No.	Description
3475	Universal

Meets or exceeds ASME B107.110



Crowfoot Wrenches, Open End

Part No.	A Nom. Size	B	C	D
1012	3/8"	3/4"	1-1/8"	13/64"
1014	7/16"	7/8"	1-1/4"	13/64"
1016	1/2"	31/32"	1-3/8"	1/4"
1018	9/16"	1-1/8"	1-1/2"	1/4"
1020	5/8"	1-1/4"	1-19/32"	5/16"
1022	11/16"	1-11/32"	1-23/32"	21/64"
1024	3/4"	1-17/32"	1-13/16"	21/64"
1026	13/16"	1-19/32"	1-15/16"	21/64"
1028	7/8"	1-3/4"	2"	11/32"
1032	1"	2-1/16"	2-1/4"	11/32"

Meets or exceeds ASME B107.100

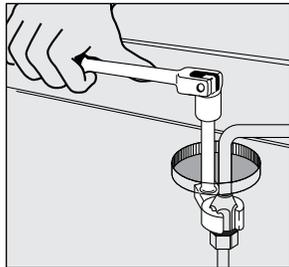
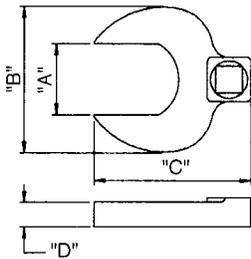

Metric Crowfoot Wrenches, Open End

Part No.	A Nom. Size	B	C	D
10-10mm	10mm	19.84	30.16	5.16
10-11mm	11mm	22.23	32.15	5.16
10-12mm	12mm	24.60	34.93	6.35
10-13mm	13mm	24.60	34.93	6.35
10-14mm	14mm	29.37	34.13	6.35
10-15mm	15mm	29.37	38.89	7.14
10-16mm	16mm	31.75	41.28	8.33
10-17mm	17mm	35.32	42.86	8.33
10-18mm	18mm	35.32	44.45	8.33
10-19mm	19mm	39.69	45.24	8.73

Meets or exceeds ASME B107.100

3/8"



Sockets, Ratchets & Attachments





Crowfoot Wrenches – Flare Nut 12 Pt.

Part No.	Nom. Size	A Width of Slot	B Dia. of Head	C Length	D Width of Head
1060	5/8"	15/32"	15/16"	47/64"	11/16"
1062	11/16"	17/32"	1-1/32"	25/32"	11/16"
1064	3/4"	9/16"	1-1/8"	53/64"	23/32"
1066	13/16"	5/8"	1-13/64"	7/8"	23/32"
1068	7/8"	11/16"	1-19/64"	15/16"	3/4"
1070	15/16"	25/32"	1-3/8"	15/16"	3/4"
1072	1"	3/4"	1-29/64"	1-1/64"	25/32"
1074	1-1/16"	25/32"	1-17/32"	1-3/64"	25/32"

Meets or exceeds ASME B107.100

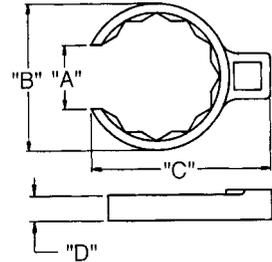
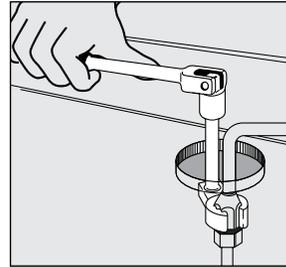

Impact Universal Joint

Part No.	Description	Overall Length
3800	Universal (Pin Lock)	2-7/16"

Meets or exceeds ASME B107.110



Impact Adaptor

Part No.	Description	Length
3899	3/8" F x 1/2" M	1-3/8"

Guarantee does not apply
Meets or exceeds ASME B107.110



Impact Extensions

Part No.	Description
3903	3" Extension (Ball)
3906	6" Extension (Ball)
3908	12" Extension (Ball)

Meets or exceeds ASME B107.110



3/8"

Sockets, Ratchets & Attachments



⑥ Pt. Standard Sockets

Part No.	Nom. Size	Shape	L	Ds	Dd	Bd
3008	1/4"	I	15/16"	7/16"	21/32"	1/8"
3010	5/16"	I	15/16"	15/32"	21/32"	9/64"
3012	3/8"	I	15/16"	37/64"	21/32"	5/32"
3014	7/16"	II	15/16"	41/64"	—	7/32"
3016	1/2"	II	1"	23/32"	—	17/64"
3018	9/16"	II	1"	49/64"	—	21/64"
3020	5/8"	II	1"	55/64"	—	3/8"
3022	11/16"	II	1"	15/16"	—	3/8"
3024	3/4"	II	1-1/8"	1"	—	7/16"
3026	13/16"	II	1-1/8"	1-5/64"	—	1/2"
3028	7/8"	II	1-9/32"	1-9/64"	—	11/16"
3030	15/16"	II	1-3/8"	1-1/4"	—	47/64"
3032	1"	II	1-3/8"	1-5/16"	—	23/32"

Meets or exceeds ASME B107.110



⑥ Pt. Standard Metric Sockets

Part No.	Nom. Size	Shape	L	Ds	Dd	Bd
30-06mm	6mm	I	24.13	10.16	15.88	3.96
30-07mm	7mm	I	24.13	10.98	15.88	3.96
30-08mm	8mm	I	24.13	12.17	15.88	5.16
30-09mm	9mm	I	25.13	13.46	15.88	5.56
30-10mm	10mm	II	24.13	15.11	—	5.94
30-11mm	11mm	II	24.13	15.88	—	7.14
30-12mm	12mm	II	24.13	17.48	—	7.95
30-13mm	13mm	II	24.13	18.29	—	7.95
30-14mm	14mm	II	24.13	19.43	—	9.93
30-15mm	15mm	II	24.13	20.57	—	9.93
30-16mm	16mm	II	25.40	22.23	—	10.31
30-17mm	17mm	II	25.40	23.37	—	9.93
30-18mm	18mm	II	25.40	24.61	—	10.31
30-19mm	19mm	II	25.40	25.40	—	11.91

Meets or exceeds ASME B107.110

3/8" Sockets, Ratchets & Attachments



Shape I

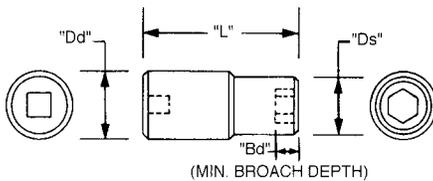

Shape II

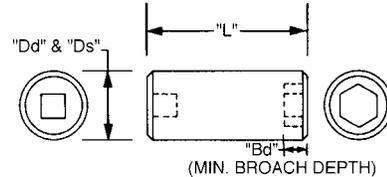

WARNING
Wear safety goggles user and bystander.



WARNING
Before using tools, read safety information on pages 399-403.



WARNING
Comfort or plastic grips do not protect against electric shock.



⑥ Pt. Deep Sockets

Part No.	Nom. Size	Shape	L	Ds	Dd	Bd
3508	1/4"	I	2-7/32"	13/32"	5/8"	5/32"
3510	5/16"	I	2-7/32"	15/32"	5/8"	5/32"
3512	3/8"	I	2-1/2"	35/64"	21/32"	5/32"
3514	7/16"	II	2-1/2"	41/64"	—	7/32"
3516	1/2"	II	2-1/2"	23/32"	—	17/64"
3518	9/16"	II	2-1/2"	49/64"	—	11/32"
3520	5/8"	II	2-1/2"	55/64"	—	3/8"
3522	11/16"	II	2-1/2"	15/16"	—	3/8"
3524	3/4"	II	2-1/2"	1"	—	1-23/32"
3526	13/16"	II	2-9/16"	1-1/16"	—	1-61/64"
3528	7/8"	II	2-7/8"	1-9/64"	—	2-1/4"
3530	15/16"	II	3-3/64"	1-1/4"	—	2-13/32"
3532	1"	II	3-3/64"	1-5/16"	—	2-3/8"

Meets or exceeds ASME B107.110



⑥ Pt. Deep Metric Sockets

Part No.	Nom. Size	Shape	L	Ds	Dd	Bd
35-06mm	6mm	I	56.36	10.16	15.88	3.96
35-07mm	7mm	I	56.36	10.98	15.88	3.96
35-08mm	8mm	I	56.36	12.17	15.88	4.78
35-09mm	9mm	I	63.50	13.46	15.88	5.94
35-10mm	10mm	II	63.50	15.11	15.88	5.94
35-11mm	11mm	II	63.50	16.66	—	7.14
35-12mm	12mm	II	63.50	17.07	—	7.95
35-13mm	13mm	II	63.50	18.29	—	7.95
35-14mm	14mm	II	63.50	19.43	—	9.93
35-15mm	15mm	II	63.50	20.57	—	9.93
35-16mm	16mm	II	63.50	22.23	—	9.93
35-17mm	17mm	II	63.50	23.37	—	9.93
35-18mm	18mm	II	63.50	24.61	—	48.43
35-19mm	19mm	II	63.50	25.40	—	48.86

Meets or exceeds ASME B107.110



⑥ Pt. Spark Plug Holding Sockets

Part No.	Nom. Size	Shape	L	Ds	Dd	Bd
3588	18mm Spark Plug Holding	I	2-1/2"	31/32"	3/4" Hex	1-1/2"
3590	5/8" Spark Plug Holding	I	2-1/2"	7/8"	3/4" Hex	1-15/32"
3596	13/16" Spark Plug Holding	I	2-5/8"	1-1/16"	7/8" Hex	1-21/32"

Meets or exceeds ASME B107.110



Refer to socket dimensional drawings on page 143.





8 Pt. Standard Sockets

Part No.	Nom. Size	Shape	L	Ds	Dd	Bd
3308	1/4"	I	1-5/64"	15/32"	5/8"	1/8"
3310	5/16"	I	1-5/64"	9/16"	5/8"	9/64"
3312	3/8"	II	1-5/64"	5/8"	–	5/32"
3314	7/16"	II	1-5/64"	3/4"	–	7/32"
3316	1/2"	II	1-5/64"	13/16"	–	17/64"
3318	9/16"	II	1-5/64"	15/16"	–	21/64"
3320	5/8"	II	1-5/64"	1-1/16"	–	3/8"
3322	11/16"	II	1-5/64"	1-9/64"	–	15/32"
3324	3/4"	II	1-5/64"	1-13/64"	–	17/32"
3326	13/16"	II	1-7/32"	1-19/64"	–	35/64"
3328	7/8"	II	1-5/16"	1-3/8"	–	39/64"

Meets or exceeds ASME B107.110

3/8"



Sockets, Ratchets & Attachments





12 Pt. Standard Sockets

Part No.	Nom. Size	Shape	L	Ds	Dd	Bd
3108	1/4"	I	15/16"	13/32"	5/8"	1/8"
3110	5/16"	I	15/16"	15/32"	21/32"	9/64"
3112	3/8"	I	15/16"	37/64"	21/32"	5/32"
3114	7/16"	II	15/16"	41/64"	—	7/32"
3116	1/2"	II	1"	23/32"	—	17/64"
3118	9/16"	II	1"	49/64"	—	21/64"
3120	5/8"	II	1"	55/64"	—	3/8"
3122	11/16"	II	1"	15/16"	—	3/8"
3124	3/4"	II	1-1/8"	1"	—	7/16"
3126	13/16"	II	1-1/8"	1-5/64"	—	29/64"
3128	7/8"	II	1-9/32"	1-9/64"	—	11/16"
3130	15/16"	II	1-3/8"	1-1/4"	—	47/64"
3132	1"	II	1-3/8"	1-5/16"	—	23/32"



Meets or exceeds ASME B107.110

12 Pt. Standard Metric Sockets

Part No.	Nom. Size	Shape	L	Ds	Dd	Bd
31-08mm	8mm	I	24.13	12.17	15.88	3.96
31-09mm	9mm	I	24.13	13.46	15.88	4.37
31-10mm	10mm	II	24.13	15.11	—	4.78
31-11mm	11mm	II	24.13	15.88	—	5.94
31-12mm	12mm	II	24.13	17.48	—	6.35
31-13mm	13mm	II	24.13	18.29	—	7.95
31-14mm	14mm	II	24.13	19.43	—	9.93
31-15mm	15mm	II	24.13	20.57	—	9.93
31-16mm	16mm	II	25.40	22.23	—	10.31
31-17mm	17mm	II	25.40	23.37	—	9.93
31-18mm	18mm	II	25.40	24.61	—	10.31
31-19mm	19mm	II	25.40	25.40	—	11.89
31-20mm	20mm	II	31.75	27.38	—	16.78
31-21mm	21mm	II	31.75	27.78	—	16.45
31-22mm	22mm	II	33.35	29.36	—	17.71



Meets or exceeds ASME B107.110

Wright Drive® 6 Pt. & 12 Pt. design sockets and combination wrenches give ten times more fastener contact area than conventional designs.

Shape I

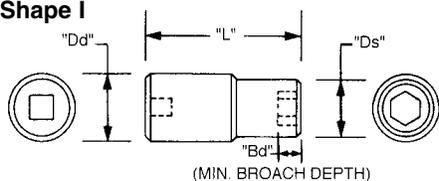

Shape II

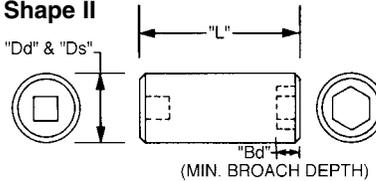

Shape III

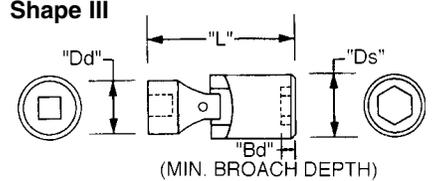

3/8"

Sockets, Ratchets & Attachments



12 Pt. Deep Sockets

Part No.	Nom. Size	Shape	L	Ds	Dd	Bd
3612	3/8"	I	2-1/2"	35/64"	21/32"	5/32"
3614	7/16"	II	2-1/2"	41/64"	—	7/32"
3616	1/2"	II	2-1/2"	23/32"	—	17/64"
3618	9/16"	II	2-1/2"	49/64"	—	21/64"
3620	5/8"	II	2-1/2"	55/64"	—	3/8"
3622	11/16"	II	2-1/2"	15/16"	—	3/8"
3624	3/4"	II	2-1/2"	1"	—	1-59/64"
3626	13/16"	II	2-9/16"	1-1/16"	—	1-61/64"
3628	7/8"	II	2-7/8"	1-9/64"	—	2-1/4"
3630	15/16"	II	3-3/64"	1-1/4"	—	2-13/32"
3632	1"	II	3-3/64"	1-5/16"	—	2-3/8"

Meets or exceeds ASME B107.110



12 Pt. Deep Metric Sockets

Part No.	Nom. Size	Shape	L	Ds	Dd	Bd
36-09mm	9mm	I	63.50	13.46	15.88	4.37
36-10mm	10mm	II	63.50	15.11	15.88	4.78
36-11mm	11mm	II	63.50	15.88	—	5.56
36-12mm	12mm	II	63.50	17.48	—	5.94
36-13mm	13mm	II	63.50	18.29	—	6.76
36-14mm	14mm	II	63.50	19.43	—	8.33
36-15mm	15mm	II	63.50	20.57	—	8.33
36-17mm	17mm	II	63.50	23.37	—	9.53
36-19mm	19mm	II	63.50	25.40	—	11.13

Meets or exceeds ASME B107.110



12 Pt. Flex Sockets

Part No.	Nom. Size	Shape	L	Ds	Dd	Bd
3712	3/8"	III	1-23/32"	9/16"	3/4"	5/16"
3714	7/16"	III	1-23/32"	5/8"	3/4"	5/16"
3716	1/2"	III	1-3/4"	3/4"	3/4"	11/32"
3718	9/16"	III	1-3/4"	3/4"	3/4"	11/32"
3720	5/8"	III	1-27/32"	7/8"	3/4"	7/16"
3722	11/16"	III	1-29/32"	15/16"	3/4"	7/16"
3724	3/4"	III	1-31/32"	1"	3/4"	1/2"

Meets or exceeds ASME B107.110

Refer to socket dimensional drawings on page 146.

Wright Drive® 6 Pt. & 12 Pt. design sockets and combination wrenches give ten times more fastener contact area than conventional designs.





⑥ Pt. Standard Sockets

Black Industrial Finish

Part No.	Nom. Size	Shape	L	Ds	Dd	Bd
33008	1/4"	I	15/16"	7/16"	21/32"	1/8"
33010	5/16"	I	15/16"	15/32"	21/32"	9/64"
33012	3/8"	I	15/16"	37/64"	21/32"	5/32"
33014	7/16"	II	15/16"	41/64"	—	7/32"
33016	1/2"	II	1"	23/32"	—	17/64"
33018	9/16"	II	1"	49/64"	—	21/64"
33020	5/8"	II	1"	55/64"	—	3/8"
33022	11/16"	II	1"	15/16"	—	3/8"
33024	3/4"	II	1-1/8"	1"	—	7/16"
33026	13/16"	II	1-1/8"	1-5/64"	—	1/2"
33028	7/8"	II	1-9/32"	1-9/64"	—	11/16"
33030	15/16"	II	1-3/8"	1-1/4"	—	47/64"
33032	1"	II	1-3/8"	1-5/16"	—	23/32"



For Hand Use Only
Meets or exceeds ASME B107.110

⑥ Pt. Deep Sockets

Black Industrial Finish

Part No.	Nom. Size	Shape	L	Ds	Dd	Bd
33508	1/4"	I	2-7/32"	13/32"	5/8"	5/32"
33510	5/16"	I	2-7/32"	15/32"	5/8"	5/32"
33512	3/8"	I	2-1/2"	35/64"	21/32"	5/32"
33514	7/16"	II	2-1/2"	41/64"	—	7/32"
33516	1/2"	II	2-1/2"	23/32"	—	17/64"
33518	9/16"	II	2-1/2"	49/64"	—	11/32"
33520	5/8"	II	2-1/2"	55/64"	—	3/8"
33522	11/16"	II	2-1/2"	15/16"	—	3/8"
33524	3/4"	II	2-1/2"	1"	—	1-23/32"
33526	13/16"	II	2-9/16"	1-1/16"	—	1-61/64"
33528	7/8"	II	2-7/8"	1-9/64"	—	2-1/4"
33530	15/16"	II	3-3/64"	1-1/4"	—	2-13/32"
33532	1"	II	3-3/64"	1-5/16"	—	2-3/8"



For Hand Use Only
Meets or exceeds ASME B107.110

Shape I

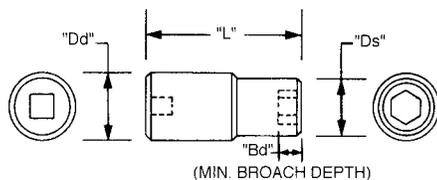

Shape II

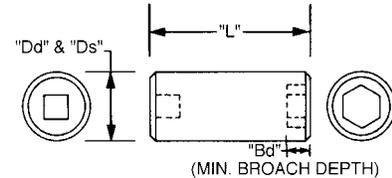

3/8" Sockets, Ratchets & Attachments



12 Pt. Standard Sockets

Black Industrial Finish

Part No.	Nom. Size	Shape	L	Ds	Dd	Bd
33108	1/4"	I	15/16"	13/32"	5/8"	1/8"
33110	5/16"	I	15/16"	15/32"	21/32"	9/64"
33112	3/8"	I	15/16"	37/64"	21/32"	5/32"
33114	7/16"	II	15/16"	41/64"	-	7/32"
33116	1/2"	II	1"	23/32"	-	17/64"
33118	9/16"	II	1"	49/64"	-	21/64"
33120	5/8"	II	1"	55/64"	-	3/8"
33122	11/16"	II	1"	15/16"	-	3/8"
33124	3/4"	II	1-1/8"	1"	-	7/16"
33126	13/16"	II	1-1/8"	1-5/64"	-	29/64"
33128	7/8"	II	1-9/32"	1-9/64"	-	11/16"
33130	15/16"	II	1-3/8"	1-1/4"	-	47/64"
33132	1"	II	1-3/8"	1-5/16"	-	23/32"

For Hand Use Only
Meets or exceeds ASME B107.110



12 Pt. Deep Sockets

Black Industrial Finish

Part No.	Nom. Size	Shape	L	Ds	Dd	Bd
33612	3/8"	I	2-1/2"	35/64"	21/32"	5/32"
33614	7/16"	II	2-1/2"	41/64"	-	7/32"
33616	1/2"	II	2-1/2"	23/32"	-	17/64"
33618	9/16"	II	2-1/2"	49/64"	-	21/64"
33620	5/8"	II	2-1/2"	55/64"	-	3/8"
33622	11/16"	II	2-1/2"	15/16"	-	3/8"
33624	3/4"	II	2-1/2"	1"	-	1-59/64"
33626	13/16"	II	2-9/16"	1-1/16"	-	1-61/64"
33628	7/8"	II	2-7/8"	1-9/64"	-	2-1/4"

For Hand Use Only
Meets or exceeds ASME B107.110

3/8" Sockets, Ratchets & Attachments

Wright Drive® 6 Pt. & 12 Pt. design sockets and combination wrenches give ten times more fastener contact area than conventional designs.

Shape I

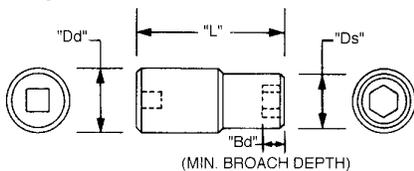

Shape II

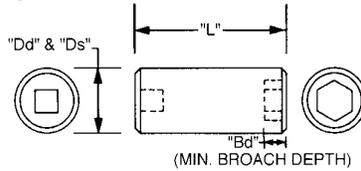

Shape III

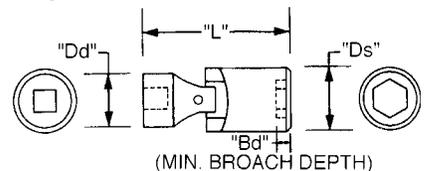



⑥ Pt. Standard Impact Sockets

Part No.	Nom. Size	Shape	L	Ds	Dd	Bd
3810	5/16"	I	1-1/16"	33/64"	3/4"	7/64"
3812	3/8"	I	1-1/16"	39/64"	3/4"	5/32"
3814	7/16"	I	1-1/16"	11/16"	3/4"	7/32"
3816	1/2"	II	1-3/32"	3/4"	—	13/64"
3818	9/16"	II	1-1/8"	55/64"	—	1/4"
3820	5/8"	II	1-1/8"	15/16"	—	9/32"
3822	11/16"	II	1-1/8"	63/64"	—	5/16"
3824	3/4"	II	1-3/16"	1-1/32"	—	23/64"

Meets or exceeds ASME B107.110



⑥ Pt. Standard Impact Metric Sockets

Part No.	Nom. Size	Shape	L	Ds	Dd	Bd
38-06mm	6mm	I	28.58	10.16	15.88	3.96
38-07mm	7mm	I	28.58	11.51	15.88	4.78
38-08mm	8mm	I	28.58	13.08	17.48	5.94
38-09mm	9mm	I	28.58	14.30	17.48	5.94
38-10mm	10mm	I	28.58	16.13	18.26	7.14
38-11mm	11mm	I	28.58	17.07	18.26	7.14
38-12mm	12mm	II	28.58	17.86	—	7.95
38-13mm	13mm	II	28.58	19.05	—	7.95
38-14mm	14mm	II	28.58	20.24	—	9.93
38-15mm	15mm	II	28.58	21.44	—	11.13
38-16mm	16mm	II	28.58	22.63	—	11.13
38-17mm	17mm	II	28.58	24.21	—	11.91
38-18mm	18mm	II	28.58	25.02	—	11.91
38-19mm	19mm	II	28.58	26.19	—	13.11

Meets or exceeds ASME B107.110



⑥ Pt. Deep Impact Sockets

Part No.	Nom. Size	Shape	L	Ds	Dd	Bd
3910	5/16"	I	2-1/4"	33/64"	3/4"	3/32"
3912	3/8"	I	2-1/4"	39/64"	3/4"	7/64"
3914	7/16"	I	2-1/4"	11/16"	3/4"	13/64"
3916	1/2"	II	2-1/4"	3/4"	—	13/64"
3918	9/16"	II	2-1/4"	55/64"	—	11/32"
3920	5/8"	II	2-1/4"	15/16"	—	3/8"
3922	11/16"	II	2-5/16"	61/64"	—	3/8"
3924	3/4"	II	2-5/16"	1-1/32"	—	7/16"

Meets or exceeds ASME B107.110



Refer to socket dimensional drawings on page 149.

3/8"



Sockets, Ratchets & Attachments





⑥ Pt. Deep Impact Metric Sockets

Part No.	Nom. Size	Shape	L	Ds	Dd	Bd
39-06mm	6mm	I	56.36	10.16	15.88	3.96
39-07mm	7mm	I	56.36	13.08	15.88	4.78
39-08mm	8mm	I	56.36	12.70	17.48	5.94
39-09mm	9mm	I	56.36	15.09	17.48	5.94
39-10mm	10mm	I	56.36	16.13	18.26	7.14
39-11mm	11mm	I	56.36	17.07	18.26	7.14
39-12mm	12mm	II	56.36	17.86	-	7.14
39-13mm	13mm	II	56.36	19.05	-	7.95
39-14mm	14mm	II	56.36	20.24	-	43.72
39-15mm	15mm	II	56.36	21.44	-	43.39
39-16mm	16mm	II	56.36	22.63	-	43.06
39-17mm	17mm	II	63.50	24.21	-	49.83
39-18mm	18mm	II	63.50	25.02	-	49.50
39-19mm	19mm	II	63.50	26.19	-	49.17

Meets or exceeds ASME B107.110



⑥ Pt. Standard Length Impact Universal Power Sockets

Part No.	Nom. Size	Shape	L	Ds	Dd	Bd
3852	3/8"	III	2-1/32"	7/8"	13/16"	7/64"
3854	7/16"	III	2-1/32"	7/8"	13/16"	13/64"
3856	1/2"	III	2-5/32"	7/8"	13/16"	13/64"
3858	9/16"	III	2-5/32"	7/8"	13/16"	5/16"
3860	5/8"	III	2-9/32"	1"	13/16"	9/32"
3862	11/16"	III	2-9/32"	1"	13/16"	5/16"
3864	3/4"	III	2-9/32"	1-1/8"	13/16"	11/32"

Guarantee does not apply

Meets or exceeds ASME B107.110



⑥ Pt. Standard Length Impact Metric Universal Power Sockets

Part No.	Nom. Size	Shape	L	Ds	Dd	Bd
38-50mm	10mm	III	51.61	22.23	20.65	5.16
38-51mm	11mm	III	51.61	22.23	20.65	5.94
38-52mm	12mm	III	54.76	22.23	20.65	5.94
38-53mm	13mm	III	54.76	22.23	20.65	7.14
38-54mm	14mm	III	54.76	22.23	20.65	7.14
38-55mm	15mm	III	57.94	25.40	20.65	7.14
38-56mm	16mm	III	57.94	25.40	20.65	9.93
38-57mm	17mm	III	57.94	25.40	20.65	11.91
38-58mm	18mm	III	57.94	25.40	20.65	11.91
38-59mm	19mm	III	57.94	28.58	20.65	11.91

Guarantee does not apply

Meets or exceeds ASME B107.110





⑥ Pt. Deep Length Universal Power Sockets

Part No.	Nom. Size	Shape	L	Ds	Dd	Bd
3952	3/8"	III	2-31/32"	7/8"	13/16"	7/64"
3954	7/16"	III	2-31/32"	7/8"	13/16"	13/64"
3956	1/2"	III	2-31/32"	7/8"	13/16"	13/64"
3958	9/16"	III	2-31/32"	7/8"	13/16"	5/16"
3960	5/8"	III	3-1/32"	1"	13/16"	9/32"
3962	11/16"	III	3-1/32"	1"	13/16"	5/16"
3964	3/4"	III	3-1/32"	1-1/8"	13/16"	11/32"

Guarantee does not apply
 Meets or exceeds ASME B107.110



⑥ Pt. Deep Length Metric Universal Power Sockets

Part No.	Nom. Size	Shape	L	Ds	Dd	Bd
39-50mm	10mm	III	75.41	22.23	20.65	5.16
39-51mm	11mm	III	75.41	22.23	20.65	5.94
39-52mm	12mm	III	75.41	22.23	20.65	5.94
39-53mm	13mm	III	75.41	22.23	20.65	7.14
39-54mm	14mm	III	75.41	22.23	20.65	7.14
39-55mm	15mm	III	75.41	25.40	20.65	7.14
39-56mm	16mm	III	76.99	25.40	20.65	9.93
39-57mm	17mm	III	76.99	25.40	20.65	11.91
39-58mm	18mm	III	76.99	25.40	20.65	11.91
39-59mm	19mm	III	76.99	28.58	20.65	11.91

Guarantee does not apply
 Meets or exceeds ASME B107.110



Shape III

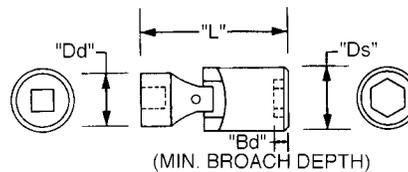



Hex Bit Sockets & Replacement Hex Bits



Replacement Hex Bits

Part No.	Nom. Size	Shape	L	Ds	Dd	L1	Replacement Bit Part No.	Bit Length
3204	1/8"	III	1-7/8"	19/32"	11/16"	13/16"	3204B	1-1/4"
3205	5/32"	III	1-7/8"	19/32"	11/16"	13/16"	3205B	1-1/4"
3206	3/16"	III	1-7/8"	19/32"	11/16"	13/16"	3206B	1-1/4"
3207	7/32"	III	1-7/8"	19/32"	11/16"	13/16"	3207B	1-1/4"
3208	1/4"	III	1-7/8"	19/32"	11/16"	13/16"	3208B	1-1/4"
3210	5/16"	III	1-7/8"	19/32"	11/16"	13/16"	3210B	1-1/4"
3212	3/8"	IV	1-7/8"	3/4"	-	13/16"	3212B	1-1/4"

Meets or exceeds ASME B107.110

Metric Hex Bit Sockets & Replacement Hex Bits



Replacement Hex Bits

Part No.	Nom. Size	Shape	L	Ds	Dd	L1	Replacement Bit Part No.	Bit Length
32-02mm	2mm	III	47.00	15.00	17.40	20.00	32M02B	31.75
32-02.5mm	2.5mm	III	47.00	15.00	17.40	20.00	32M02.5B	31.75
32-03mm	3mm	III	47.00	15.00	17.40	20.00	32M03B	31.75
32-04mm	4mm	III	47.00	15.00	17.40	20.00	32M04B	31.75
32-05mm	5mm	III	47.00	15.00	17.40	20.00	32M05B	31.75
32-06mm	6mm	III	47.00	15.00	17.40	20.00	32M06B	31.75
32-07mm	7mm	III	47.00	15.00	17.40	20.00	32M07B	31.75
32-08mm	8mm	III	47.00	15.00	17.40	20.00	32M08B	31.75
32-10mm	10mm	IV	47.00	19.00	-	20.00	32M10B	31.75

Meets or exceeds ASME B107.110

Shape III

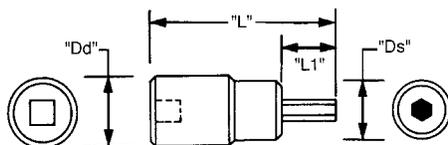

Shape IV

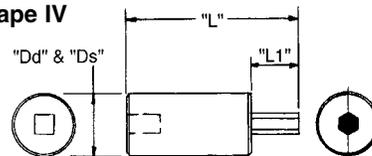



Long Hex Bit Sockets & Replacement Long Hex Bits

Part No.	Nom. Size	Shape	L	Ds	Dd	L1	Replacement Bit Part No.	Bit Length
32L04	1/8"	III	6-1/8"	19/32"	11/16"	5-1/16"	32L04B	5-1/2"
32L05	5/32"	III	6-1/8"	19/32"	11/16"	5-1/16"	32L05B	5-1/2"
32L06	3/16"	III	6-1/8"	19/32"	11/16"	5-1/16"	32L06B	5-1/2"
32L07	7/32"	III	6-1/8"	19/32"	11/16"	5-1/16"	32L07B	5-1/2"
32L08	1/4"	III	6-1/8"	19/32"	11/16"	5-1/16"	32L08B	5-1/2"
32L10	5/16"	III	6-1/8"	19/32"	11/16"	5-1/16"	32L10B	5-1/2"
32L12	3/8"	IV	6-17/64"	3/4"	-	5-5/64"	32L12B	5-1/2"

Meets or exceeds ASME B107.110

Long Metric Hex Bit Sockets & Replacement Long Hex Bits

Part No.	Nom. Size	Shape	L	Ds	Dd	L1	Replacement Bit Part No.	Bit Length
32L-04mm	4mm	III	155.45	14.94	17.48	128.27	32L-04MMB	139.70
32L-05mm	5mm	III	155.45	14.94	17.48	128.27	32L-05MMB	139.70
32L-06mm	6mm	III	155.45	14.94	17.48	128.27	32L-06MMB	139.70
32L-08mm	8mm	III	155.45	14.94	17.48	128.27	32L-08MMB	139.70
32L-10mm	10mm	IV	158.00	19.00	-	128.27	32L-10MMB	139.70

Meets or exceeds ASME B107.110

Shape III

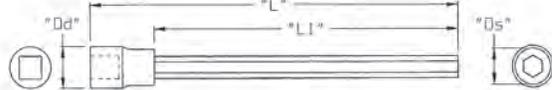

Shape IV



Impact Hex Bit Sockets & Replacement Hex Bits

Part No.	Nom. Size	L	Dd	L1	Bit Length	Replacement Bit Part No.
32B04	1/8"	2"	3/4"	13/16"	1-1/4"	32B04B
32B05	5/32"	2"	3/4"	13/16"	1-1/4"	32B05B
32B06	3/16"	2"	3/4"	13/16"	1-1/4"	32B06B
32B07	7/32"	2"	3/4"	13/16"	1-1/4"	32B07B
32B08	1/4"	2"	3/4"	13/16"	1-1/4"	32B08B
32B10	5/16"	2"	3/4"	13/16"	1-1/4"	32B10B
32B12	3/8"	2"	3/4"	13/16"	1-1/4"	32B12B

Meets or exceeds ASME B107.110

Metric Impact Hex Bit Sockets & Replacement Hex Bits

Part No.	Nom. Size	L	Dd	L1	Bit Length	Replacement Bit Part No.
32B-02mm	2mm	50.80	19.05	20.62	31.75	32BM02B
32B-02.5mm	2.5mm	50.80	19.05	20.62	31.75	32BM02.5B
32B-03mm	3mm	50.80	19.05	20.62	31.75	32BM03B
32B-04mm	4mm	50.80	19.05	20.62	31.75	32BM04B
32B-05mm	5mm	50.80	19.05	20.62	31.75	32BM05B
32B-06mm	6mm	50.80	19.05	20.62	31.75	32BM06B
32B-07mm	7mm	50.80	19.05	20.62	31.75	32BM07B
32B-08mm	8mm	50.80	19.05	20.62	31.75	32BM08B
32B-10mm	10mm	50.80	19.05	20.62	31.75	32BM10B

Meets or exceeds ASME B107.110

www.wrighttool.com

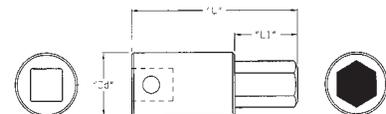

3/8"



Sockets, Ratchets & Attachments



Replacement Screwdriver Bit

Standard Screwdriver Sockets with Bits & Replacement Bits

Part No.	Nom. Size	Socket Dia.	Overall Length	Replacement Bit Part No.	Bit Length
3260	1/4"	11/16"	1-7/8"	3260B	1-1/64"
3261	5/16"	11/16"	1-7/8"	3261B	1-1/64"
3262	3/8"	11/16"	1-7/8"	3262B	1-1/64"

Meets or exceeds ASME B107.110



Replacement Phillips Screwdriver Bit

Phillips Screwdriver Sockets with Bits & Replacement Bits

Part No.	Nom. Size	Socket Dia.	Overall Length	Replacement Bit Part No.	Bit Length
3265	#1	11/16"	1-13/16"	3265B	1"
3266	#2	11/16"	1-13/16"	3266B	1"
3267	#3	11/16"	1-13/16"	3267B	1-1/64"
3268	#4	11/16"	2-1/16"	3268B	1-1/4"

Meets or exceeds ASME B107.110



Torx Bit Holder Sets

Part Description

9295	Torx Bit Set - 8 Pieces 9271, 9272, 9273, 9274, 9275, 9276, 9277 Torx Bits, 9280 Bit Holder
9296	Torx Bit Set - 7 Pieces 9281, 9282, 9283, 9284, 9285, 9286 Torx Bits, 9290 Bit Holder

3/8"



Sockets, Ratchets & Attachments





Torx Sockets

Part No.	Dr. Sq. Size	Shape	Head Size	L	Ds	Dd
9255	3/8"	I	E-10	1-1/4"	1/2"	11/16"
9256	3/8"	I	E-12	1-1/4"	5/8"	11/16"
9257	3/8"	II	E-14	1-1/4"	11/16"	-
9258	3/8"	II	E-16	1-1/4"	3/4"	-

Meets or exceeds ASME B107.110

Shape II

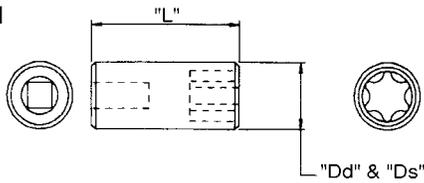

Shape I



Torx Bits

Part No.	Hex Size	Shape	Bit Size	L
9281	5/16"	I	6mm Ribe	1-1/4"
9282	5/16"	II	T-30	1-1/4"
9283	5/16"	II	T-40	1-1/4"
9284	5/16"	II	T-45	1-1/4"
9285	5/16"	II	T-47	1-1/4"
9286	5/16"	II	T-50	1-1/4"

Meets or exceeds ASME B107.110

Shape II

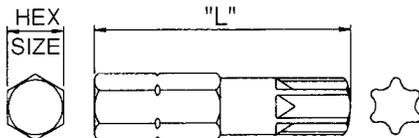

Shape I

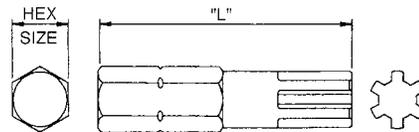

Torx Bit Holders

Part No.	Dr. Sq. Size	Shape	Hex Size	L	Ds	Dd
9290	3/8" Dr. 5/16"	I	5/16"	1-1/4"	9/16"	11/16"
9292	3/8" Dr. 7/16"	I	7/16"	1-1/2"	7/8"	11/16"

Meets or exceeds ASME B107.110



Shape I

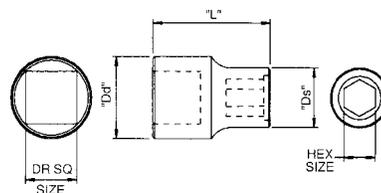

3/8"



Sockets, Ratchets & Attachments



We Have The

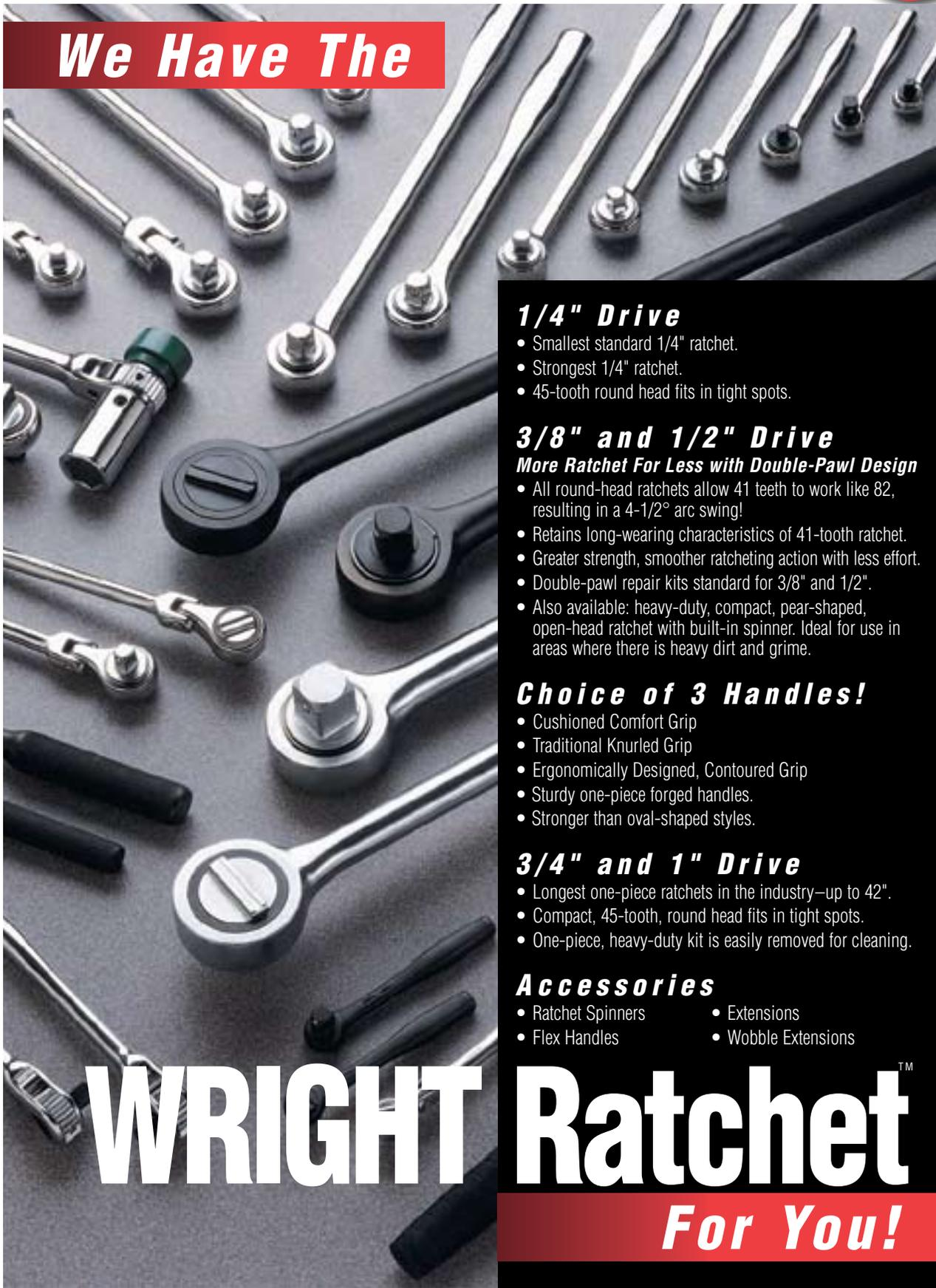

1/4" Drive

- Smallest standard 1/4" ratchet.
- Strongest 1/4" ratchet.
- 45-tooth round head fits in tight spots.

3/8" and 1/2" Drive

More Ratchet For Less with Double-Pawl Design

- All round-head ratchets allow 41 teeth to work like 82, resulting in a 4-1/2° arc swing!
- Retains long-wearing characteristics of 41-tooth ratchet.
- Greater strength, smoother ratcheting action with less effort.
- Double-pawl repair kits standard for 3/8" and 1/2".
- Also available: heavy-duty, compact, pear-shaped, open-head ratchet with built-in spinner. Ideal for use in areas where there is heavy dirt and grime.

Choice of 3 Handles!

- Cushioned Comfort Grip
- Traditional Knurled Grip
- Ergonomically Designed, Contoured Grip
- Sturdy one-piece forged handles.
- Stronger than oval-shaped styles.

3/4" and 1" Drive

- Longest one-piece ratchets in the industry—up to 42".
- Compact, 45-tooth, round head fits in tight spots.
- One-piece, heavy-duty kit is easily removed for cleaning.

Accessories

- Ratchet Spinners
- Flex Handles
- Extensions
- Wobble Extensions

WRIGHT Ratchet™

For You!

3/8"



Sockets, Ratchets & Attachments





27 Pieces – 12 Pt. Standard & Deep Socket Set Set No. 427

Part No.	Description	Part No.	Description
12 Pt. Standard Sockets			
4114	7/16"	4128	7/8"
4116	1/2"	4130	15/16"
4118	9/16"	4132	1"
4120	5/8"	4134	1-1/16"
4122	11/16"	4136	1-1/8"
4124	3/4"	4140	1-1/4"
4126	13/16"		
12 Pt. Deep Sockets			
4616	1/2"	4624	3/4"
4618	9/16"	4626	13/16"
4620	5/8"	4628	7/8"
4622	11/16"	4630	15/16"
Attachments			
4426	Ratchet	4445	Speeder
4405	5" Extension	4475	Universal
4410	10" Extension	WT520	Metal Box
4435	Flex Handle		



25 Pieces – 12 Pt. Standard Socket Set Set No. 424

Part No.	Description	Part No.	Description
4112	3/8"	4131	31/32"
4114	7/16"	4132	1"
4116	1/2"	4134	1-1/16"
4118	9/16"	4136	1-1/8"
4119	19/32"	4138	1-3/16"
4120	5/8"	4140	1-1/4"
4121	21/32"	4426	Ratchet, 10-1/2"
4122	11/16"	4402	2" Extension
4124	3/4"	4405	5" Extension
4125	25/32"	4410	10" Extension
4126	13/16"	4435	Flex Handle
4128	7/8"	4475	Universal
4130	15/16"	W418	Metal Box



1/2"



Sockets, Ratchets & Attachments





24 Pieces – 12 Pt. Standard & Deep Socket Set Set No. 425

Part No.	Description	Part No.	Description
12 Pt. Standard Sockets			
4114	7/16"	4128	7/8"
4116	1/2"	4130	15/16"
4118	9/16"	4132	1"
4120	5/8"	4134	1-1/16"
4122	11/16"	4136	1-1/8"
4124	3/4"	4140	1-1/4"
4126	13/16"		
12 Pt. Deep Sockets			
4616	1/2"	4624	3/4"
4618	9/16"	4626	13/16"
4620	5/8"	4628	7/8"
4622	11/16"	4630	15/16"
Attachments			
4426	Ratchet	4435	Flex Handle
4410	10" Extension	WT528	Metal Box



18 Pieces – 6 Pt. Standard Socket Set Set No. 423

Part No.	Description	Part No.	Description
4012	3/8"	4032	1"
4014	7/16"	4034	1-1/16"
4016	1/2"	4036	1-1/8"
4018	9/16"	4038	1-3/16"
4020	5/8"	4040	1-1/4"
4022	11/16"	4426	Ratchet, 10-1/2"
4024	3/4"	4405	5" Extension
4026	13/16"	4435	Flex Handle
4028	7/8"	W417	Metal Box
4030	15/16"		

1/2"



Sockets, Ratchets & Attachments





**19 Pieces – 12 Pt. Standard Socket Set
 Set No. 422**

Part No.	Description	Part No.	Description
4112	3/8"	4132	1"
4114	7/16"	4134	1-1/16"
4116	1/2"	4136	1-1/8"
4118	9/16"	4138	1-3/16"
4120	5/8"	4140	1-1/4"
4122	11/16"	4426	Ratchet
4124	3/4"	4405	5" Extension
4126	13/16"	4435	Flex Handle
4128	7/8"	4475	Universal
4130	15/16"	W417	Metal Box



**15 Pieces – 12 Pt. Standard Socket Set
 Set No. 417**

Part No.	Description	Part No.	Description
4114	7/16"	4130	15/16"
4116	1/2"	4132	1"
4118	9/16"	4134	1-1/16"
4120	5/8"	4136	1-1/8"
4122	11/16"	4140	1-1/4"
4124	3/4"	4426	Ratchet
4126	13/16"	4405	5" Extension
4128	7/8"	W411	Metal Box



**12 Pieces – 12 Pt. Standard Socket Set
 Set No. 418**

Part No.	Description	Part No.	Description
4114	7/16"	4128	7/8"
4116	1/2"	4130	15/16"
4118	9/16"	4132	1"
4120	5/8"	4426	Ratchet
4122	11/16"	4405	5" Extension
4124	3/4"	W411	Metal Box
4126	13/16"		



1/2"



Sockets, Ratchets & Attachments





14 Pieces – 6 Pt. Standard Socket Set Set No. 419

Part No.	Description	Part No.	Description
4014	7/16"	4030	15/16"
4016	1/2"	4032	1"
4018	9/16"	4034	1-1/16"
4020	5/8"	4036	1-1/8"
4022	11/16"	4038	1-3/16"
4024	3/4"	4040	1-1/4"
4026	13/16"	2-W010	Rails
4028	7/8"	W4	14 Clips



13 Pieces – 8 Pt. Standard Socket Set Set No. 450

Part No.	Description	Part No.	Description
4314	7/16"	4330	15/16"
4316	1/2"	4332	1"
4318	9/16"	4334	1-1/16"
4320	5/8"	4336	1-1/8"
4322	11/16"	4340	1-1/4"
4324	3/4"	2-W010	Rails
4326	13/16"	W4	13 Clips
4328	7/8"		



14 Pieces – 12 Pt. Standard Socket Set Set No. 416

Part No.	Description	Part No.	Description
4114	7/16"	4130	15/16"
4116	1/2"	4132	1"
4118	9/16"	4134	1-1/16"
4120	5/8"	4136	1-1/8"
4122	11/16"	138	1-3/16"
4124	3/4"	4140	1-1/4"
4126	13/16"	2-W010	Rails
4128	7/8"	W4	14 Clips

1/2"



Sockets, Ratchets & Attachments





11 Pieces – 12 Pt. Deep Socket Set Set No. 402

Part No.	Description	Part No.	Description
4616	1/2"	4630	15/16"
4618	9/16"	4632	1"
4620	5/8"	4634	1-1/16"
4622	11/16"	4636	1-1/8"
4624	3/4"	W013	Rail
4626	13/16"	W4	11 Clips
4628	7/8"		



8 Pieces – 12 Pt. Deep Socket Set Set No. 409

Part No.	Description	Part No.	Description
4616	1/2"	4626	13/16"
4618	9/16"	4628	7/8"
4620	5/8"	4630	15/16"
4622	11/16"	W010	Rail
4624	3/4"	W4	8 Clips



8 Pieces – 6 Pt. Deep Socket Set Set No. 410

Part No.	Description	Part No.	Description
4516	1/2"	4526	13/16"
4518	9/16"	4528	7/8"
4520	5/8"	4530	15/16"
4522	11/16"	W010	Rail
4524	3/4"	W4	8 Clips



1/2"



Sockets, Ratchets & Attachments





11 Pieces – 6 Pt. Deep Socket Set Set No. 414

Part No.	Description	Part No.	Description
4516	1/2"	4530	15/16"
4518	9/16"	4532	1"
4520	5/8"	4534	1-1/16"
4522	11/16"	4536	1-1/8"
4524	3/4"	W013	Rail
4526	13/16"	W4	11 Clips
4528	7/8"		



7 Pieces – Hex Bit Socket Set Set No. 405

Part No.	Description	Part No.	Description
4208	1/4"	4216	1/2"
4210	5/16"	4218	9/16"
4212	3/8"	4220	5/8"
4214	7/16"	229	Plastic Box

1/2"



Sockets, Ratchets & Attachments





**7 Piece – Long Length Hex Bit
Socket Set
Set No. 406**

Part No.	Description	Part No.	Description
42L08	1/4"	42L16	1/2"
42L10	5/16"	42L18	9/16"
42L12	3/8"	42L20	5/8"
42L14	7/16"	W008	Rail
		W4	7 Clips



1/2"



**15 Pieces – Flare Nut, 12 Pt.
Crowfoot Wrench Set
Set No. 703**

Part No.	Description	Part No.	Description
1080	1-1/8"	1089	1-11/16"
1081	1-3/16"	1090	1-3/4"
1082	1-1/4"	1091	1-13/16"
1083	1-5/16"	1092	1-7/8"
1084	1-3/8"	1093	1-15/16"
1085	1-7/16"	1094	2"
1086	1-1/2"	2-W010	Rails
1087	1-9/16"	W4	15 Clips
1088	1-5/8"		



Sockets, Ratchets & Attachments





22 Pieces – 12 Pt. Standard Metric Socket Set Set No. 472

Part No.	Description	Part No.	Description
41-09mm	9mm	41-21mm	21mm
41-10mm	10mm	41-22mm	22mm
41-11mm	11mm	41-23mm	23mm
41-12mm	12mm	41-24mm	24mm
41-13mm	13mm	41-25mm	25mm
41-14mm	14mm	41-26mm	26mm
41-15mm	15mm	41-30mm	30mm
41-16mm	16mm	41-32mm	32mm
41-17mm	17mm	4426	Ratchet
41-18mm	18mm	4405	5" Extension
41-19mm	19mm	W418	Metal Box
41-20mm	20mm		

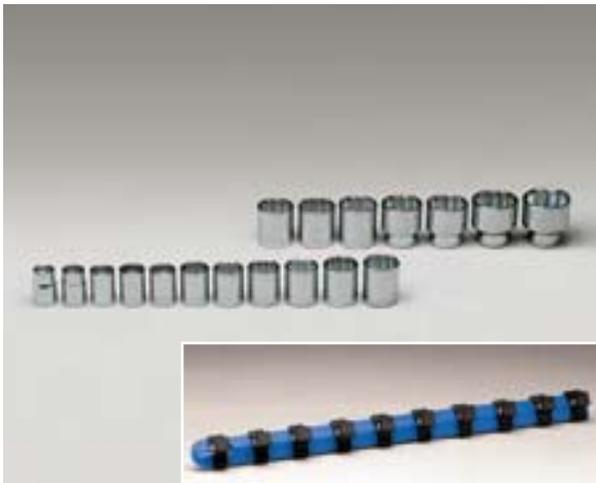

18 Pieces – 12 Pt. Standard Metric Socket Set Set No. 469

Part No.	Description	Part No.	Description
41-12mm	12mm	41-22mm	22mm
41-13mm	13mm	41-23mm	23mm
41-14mm	14mm	41-24mm	24mm
41-15mm	15mm	41-25mm	25mm
41-16mm	16mm	41-26mm	26mm
41-17mm	17mm	41-27mm	27mm
41-18mm	18mm	41-30mm	30mm
41-19mm	19mm	41-32mm	32mm
41-20mm	20mm	2-W110	Rails
41-21mm	21mm	W4	18 Clips



10 Pieces – 12 Pt. Deep Metric Socket Set Set No. 473

Part No.	Description	Part No.	Description
46-16mm	16mm	46-22mm	22mm
46-17mm	17mm	46-24mm	24mm
46-18mm	18mm	46-25mm	25mm
46-19mm	19mm	46-26mm	26mm
46-20mm	20mm	W113	Rail
46-21mm	21mm	W4	10 Clips



1/2"



Sockets, Ratchets & Attachments



**6 Pieces – Hex Bit Socket Set
 Set No. 453**

Part No.	Description	Part No.	Description
42-06mm	6mm	42-14mm	14mm
42-08mm	8mm	42-17mm	17mm
42-10mm	10mm	230	Plastic Box
42-12mm	12mm		



**6 Piece – Long Length Metric Hex
 Bit Socket Set
 Set No. 454**

Part No.	Description	Part No.	Description
42L-06mm	6mm	42L-14mm	14mm
42L-08mm	8mm	42L-17mm	17mm
42L-10mm	10mm	W108	Rail
42L-12mm	12mm	W4	6 Clips



1/2"



Sockets, Ratchets & Attachments





7 Pieces – 6 Pt. Standard Impact Socket Set Set No. 408

Part No.	Description	Part No.	Description
4814	7/16"	4824	3/4"
4816	1/2"	4826	13/16"
4818	9/16"	W008	Rail
4820	5/8"	W4	7 Clips
4822	11/16"		



11 Pieces – 6 Pt. Standard Impact Socket Set Set No. 411

Part No.	Description	Part No.	Description
4814	7/16"	4828	7/8"
4816	1/2"	4830	15/16"
4818	9/16"	4382	1"
4820	5/8"	4834	1-1/16"
4822	11/16"	W013	Rail
4824	3/4"	W4	11 Clips
4826	13/16"		



13 Pieces – 6 Pt. Standard Impact Socket Set Set No. 415

Part No.	Description	Part No.	Description
4814	7/16"	4830	15/16"
4816	1/2"	4832	1"
4818	9/16"	4834	1-1/16"
4820	5/8"	4836	1-1/8"
4822	11/16"	4840	1-1/4"
4824	3/4"	2-W010	Rails
4826	13/16"	W4	13 Clips
4828	7/8"		





**14 Pieces – ⑥ Pt. Deep Impact
 Socket Set
 Set No. 407**

Part No.	Description	Part No.	Description
4912	3/8"	4928	7/8"
4914	7/16"	4930	15/16"
4916	1/2"	4932	1"
4918	9/16"	4934	1-1/16"
4920	5/8"	4936	1-1/8"
4922	11/16"	4940	1-1/4"
4924	3/4"	2-W010	Rails
4926	13/16"	W4	14 Clips



**11 Pieces – ⑥ Pt. Deep Impact
 Socket Set
 Set No. 412**

Part No.	Description	Part No.	Description
4912	3/8"	4926	13/16"
4914	7/16"	4928	7/8"
4916	1/2"	4930	15/16"
4918	9/16"	4932	1"
4920	5/8"	W013	Rail
4922	11/16"	W4	11 Clips
4924	3/4"		



**7 Pieces – Impact Hex Bit
 Socket Set
 Set No. 403**

Part No.	Description	Part No.	Description
42B08	1/4"	42B18	9/16"
42B10	5/16"	42B20	5/8"
42B12	3/8"	W008	Rail
42B14	7/16"	W4	7 Clips
42B16	1/2"		



1/2"



Sockets, Ratchets & Attachments





16 Pieces – ⑥ Pt. Standard Metric Socket Set Set No. 466

Part No.	Description	Part No.	Description
48-10mm	10mm	48-19mm	19mm
48-11mm	11mm	48-20mm	20mm
48-12mm	12mm	48-21mm	21mm
48-13mm	13mm	48-22mm	22mm
48-14mm	14mm	48-23mm	23mm
48-15mm	15mm	48-24mm	24mm
48-16mm	16mm	48-27mm	27mm
48-17mm	17mm	2-W110	Rails
48-18mm	18mm	W4	16 Clips

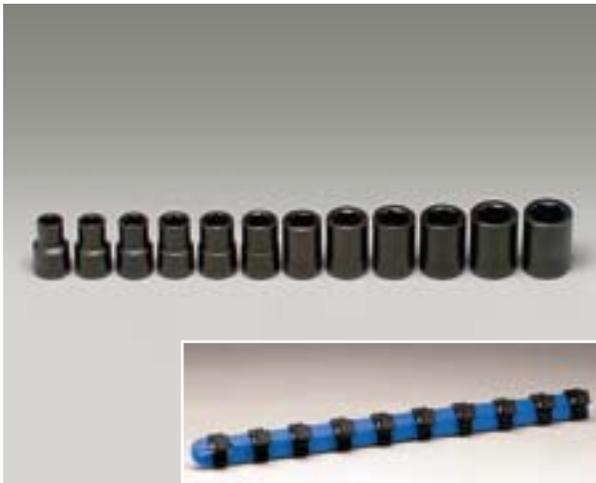

12 Pieces – ⑥ Pt. Standard Metric Impact Socket Set Set No. 460

Part No.	Description	Part No.	Description
48-10mm	10mm	48-17mm	17mm
48-11mm	11mm	48-18mm	18mm
48-12mm	12mm	48-19mm	19mm
48-13mm	13mm	48-20mm	20mm
48-14mm	14mm	48-21mm	21mm
48-15mm	15mm	W113	Rail
48-16mm	16mm	W4	12 Clips

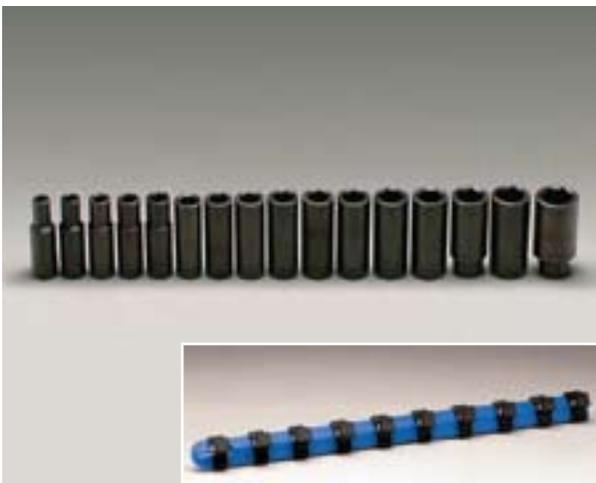

16 Pieces – ⑥ Pt. Deep Metric Impact Socket Set Set No. 467

Part No.	Description	Part No.	Description
49-10mm	10mm	49-19mm	19mm
49-11mm	11mm	49-20mm	20mm
49-12mm	12mm	49-21mm	21mm
49-13mm	13mm	49-22mm	22mm
49-14mm	14mm	49-23mm	23mm
49-15mm	15mm	49-24mm	24mm
49-16mm	16mm	49-27mm	27mm
49-17mm	17mm	2-W110	Rails
49-18mm	18mm	W4	16 Clips

1/2"



Sockets, Ratchets & Attachments





12 Pieces – 6 Pt. Deep Metric Impact Socket Set Set No. 461

Part No.	Description	Part No.	Description
49-10mm	10mm	49-17mm	17mm
49-11mm	11mm	49-18mm	18mm
49-12mm	12mm	49-19mm	19mm
49-13mm	13mm	49-20mm	20mm
49-14mm	14mm	49-21mm	21mm
49-15mm	15mm	W113	Rail
49-16mm	16mm	W4	12 Clips

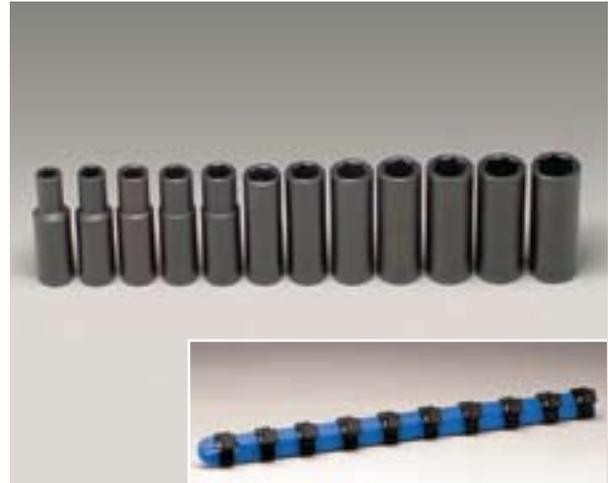

1/2"



Sockets, Ratchets & Attachments

6 Pieces – Metric Impact Hex Bit Socket Set Set No. 455

Part No.	Description	Part No.	Description
42B-06MM	6mm	42B-14MM	14mm
42B-08MM	8mm	42B-17MM	17mm
42B-10MM	10mm	W108	Rail
42B-12MM	12mm	W4	6 Clips





5 Piece Adaptor Set Set No. 9501

Part No.	Description
2453	1/4" Drive Adaptor 1/4" F x 3/8" M
3452	3/8" Drive Adaptor 3/8" F x 1/4" M
3454	3/8" Drive Adaptor 3/8" F x 1/2" M
4453	1/2" Drive Adaptor 1/2" F x 3/8" M
4902	1/2" Drive Impact Adaptor 1/2" F x 3/4" M (Ball Lock)
W010	Rail
W2	1 Clip
W3	2 Clips
W4	2 Clips



4 Piece Adaptor Set Set No. 9500

Part No.	Description
3899	3/8" Drive Impact Adaptor 3/8" F x 1/2" M (Ball Lock)
4900	1/2" Drive Impact Adaptor 1/2" F x 3/8" M (Ball Lock)
4902	1/2" Drive Impact Adaptor 1/2" F x 3/4" M (Ball Lock)
6900	3/4" Drive Impact Adaptor 3/4" F x 1/2" M (Ball Lock)
Cardboard Box	

1/2"



Sockets, Ratchets & Attachments





Ratchets

Two Head Styles – Round and Pear Shape

• Wright Tool 1/2" drive ratchets are the workhorses of the industry. Compact round and pear shaped heads, short handle arc swings, easily changed kits, choice of handle style and problem solving designs. The ratchets are engineered to balance within normal range of sockets to minimize the "nose heavy feeling."

• Round-head ratchets are 45 tooth design. Single pawl delivers 8° arc, double pawl gives 90 tooth action on 4-1/2° of arc. Pear shaped ratchets are so compact they are the same head size as most 3/8" drive ratchets. This drop-forged unit is strong and versatile enough to be used as a scaffold hammer. It is highly favored in high dirt situations because it is so easily cleaned.



4426



4433



4400



4480



4401



4427



4490

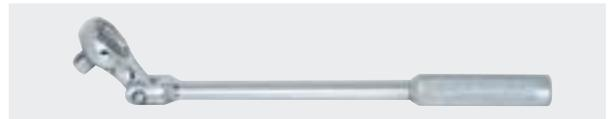

4430



4425

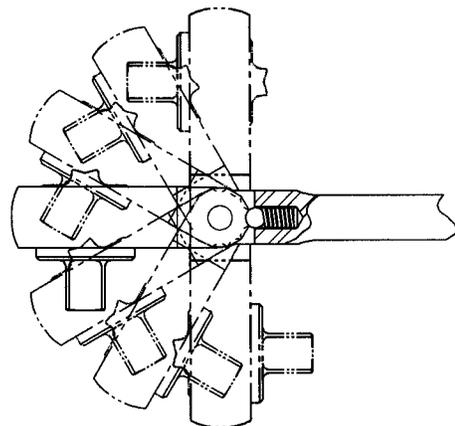

Seven Place Indexing Flex Head 4427, 4430



4494



4482



34426



4428

1/2"



Sockets, Ratchets & Attachments





Part No.	Description	Length Overall	Swing Arc	No. of Teeth	Head Dia.	Renewal Kit No.
4400	Nitrile Comfort Grip—Double Pawl	10-1/2"	1-1/4"	45	1-5/8"	4491
4401	Short Nitrile Comfort Grip—Double Pawl	8-3/8"	1-1/4"	45	1-5/8"	4491
4425	Long Knurled Grip—Double Pawl	15"	2"	45	1-5/8"	4491
4426	Knurled Grip—Double Pawl	10-1/4"	1-1/4"	45	1-5/8"	4491
4427	Flex Head Knurled Grip—Double Pawl	12-1/4"	1-1/4"	45	1-5/8"	4491
4428	Construction Spud Ratchet, Black, 1/2" Sq. Drive, 15" Heavy Duty Round Head—Double Pawl	15"	2"	45	1-5/8"	34491
4430	Flex Head Knurled Grip—Double Pawl	18"	2-1/4"	45	1-5/8"	4491
4433	Knurled Handle, Raised Cap, Lineman's Ratchet—Double Pawl	10-1/4"	1-1/4"	45	1-5/8"	4432
4480	Open Head, Pear Shape—Single Pawl	10-1/2"	3-1/4"	30	1-5/16"	4481
4482	Pear Head, Contour Handle Scaffold Wrench, Soft Face Hammer head/special 7/8" socket—Single Pawl	10-1/2"	3-1/4"	30	1-5/16"	N/A
4490	Contour Grip—Double Pawl	11"	1-1/4"	45	1-5/8"	4491
4494	Long Contour Grip—Double Pawl	15"	2"	45	1-5/8"	4491
34426	Knurled Handle, Black—Double Pawl	10-1/4"	1-1/4"	45	1-5/8"	34491

Double Pawl allows 45 teeth to operate with 90 tooth action and a 4-1/2° arc swing. Meets or exceeds ASME B107.110



Premium Double Pawl

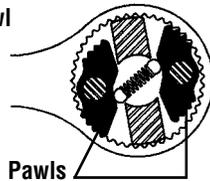

Renewal Kits & Replacement Parts

One piece, foolproof. Just drop into place. Extends life of ratchet. On-the-spot purchase eliminates waiting for repair.

Part No.	Description
4432	For 4433 Ratchet (Double Pawl)
4481	For 4480 Ratchet (Single Pawl)
4491	For 4400, 4401, 4425, 4426, 4427, 4430, 4490, 4494 Ratchets (Double Pawl)
34491	For 34426, 4428 Ratchet, Black (Double Pawl)
9039	Replacement Tip for 4482 Scaffold Ratchet

NOTE: When cleaning your ratchet lubricate with light oil only.





Flex Handles

Steel pin and tension washer construction for extra strength. No binding or locked joints.

Part No.	Description	Overall Length
4434	Knurled Steel Handle	24"
4435	Knurled Steel Handle	18"
4437	Knurled Steel Handle	10-5/8"
4438	Nitrile Handle	18"
4439	Contour Handle	16-9/16"
34435	Black Knurled Steel Handle	18"

Meets or exceeds ASME B107.110

- With swivel blocks at both ends, our Twin Flex wrench handle accommodates two different sizes of types of attachments.
- This makes it easy to customize for special situations that require more than one tool.
- Adding various combinations of sockets or crowfoot wrench ends lets you use the Twin Flex as a flare nut wrench, breaker bar, crank or speed handle.

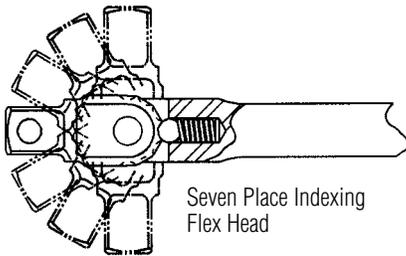

4434



4435



4437



4438



4439



34435



Mechanics who are known by the quality of their tools appreciate the quality of *wright tools!*





Sliding T

Head held in place by friction ball so it can slide to ends of bar with no overhang. Works in tighter places.

Part No.	Description
----------	-------------

4443	10-11/16"
------	-----------

Meets or exceeds ASME B107.110



Speeder

Part No.	Description
----------	-------------

4445	Speeder 16-3/4" long
------	----------------------

Meets or exceeds ASME B107.110



Extensions

Part No.	Description
----------	-------------

4402	1-1/2"
4405	5"
4410	10"
4420	20"

Meets or exceeds ASME B107.110

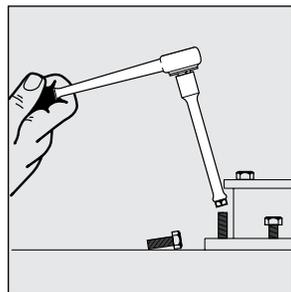

Wobble Extensions

Part No.	Description
----------	-------------

4409	2"
------	----

Meets or exceeds ASME B107.110

1/2"



Sockets, Ratchets & Attachments





Adaptor

For interchanges of sockets and attachments from one drive size to another.

Part No.	Description	Length
4453	1/2" F x 3/8" M	1-1/2"

Meets or exceeds ASME B107.110



Locking Adaptor

Part No.	Description
4413	Set Screw - Locking Adaptor 1/2" F x 1/2" M

Meets or exceeds ASME B107.110



Universal

Built-in spring tension for easy application to the nut. No binding or locked joints. No sharp corners.

Part No.	Description
4475	Universal

Meets or exceeds ASME B107.110



1/2"



Sockets, Ratchets & Attachments



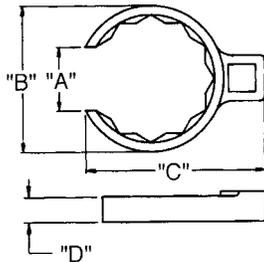
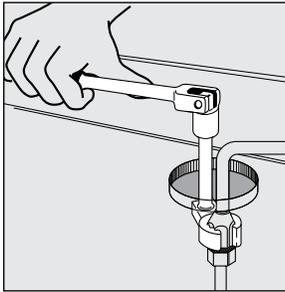

Crowfoot Wrenches – Flare Nut ¹²Pt.

Part No.	Nom. Size	A Width of Slot	B Dia. of Head	C	D
1080	1-1/8"	27/32"	1-5/8"	25/16"	7/8"
1081	1-3/16"	29/32"	1-11/16"	2-3/8"	7/8"
1082	1-1/4"	15/16"	1-25/32"	2-3/8"	7/8"
1083	1-5/16"	31/32"	1-27/32"	2-1/2"	7/8"
1084	1-3/8"	1-1/16"	1-15/16"	2-9/16"	15/16"
1085	1-7/16"	1-1/16"	2"	2-5/8"	15/16"
1086	1-1/2"	1-1/8"	2-1/16"	2-11/16"	15/16"
1087	1-9/16"	1-5/32"	2-5/32"	2-3/4"	15/16"
1088	1-5/8"	1-7/32"	2-7/32"	2-3/4"	15/16"
1089	1-11/16"	1-5/16"	2-5/16"	2-7/8"	1"
1090	1-3/4"	1-5/16"	2-3/8"	2-15/16"	1"
1091	1-13/16"	1-11/32"	2-15/32"	3"	1"
1092	1-7/8"	1-3/8"	2-9/16"	3-1/8"	1-1/16"
1093	1-15/16"	1-7/16"	2-5/8"	3-1/4"	1-1/16"
1094	2"	1-9/16"	2-23/32"	3-1/4"	1-1/16"

Meets or exceeds ASME B107.100

Impact Universal Joint

Part No.	Description	Overall Length
----------	-------------	----------------

4800	Universal (Pin Lock)	2-11/16"
------	----------------------	----------

Meets or exceeds ASME B107.110

Adaptor

Part No.	Description	Length
----------	-------------	--------

4422	7/16" Hex M x 1/2" Sq./ Pin Lock	2-1/8"
------	----------------------------------	--------

Meets or exceeds ASME B107.110

Impact Adaptors

Part No.	Description	Length
----------	-------------	--------

4900	1/2" F x 3/8" M (Ball Lock)	1-1/2"
4902	1/2" F x 3/4" M (Ball Lock)	2"

Guarantee does not apply

Meets or exceeds ASME B107.110

Impact Extensions

Part No.	Description
----------	-------------

4903	2" Pin Lock
4905	5" Ball Lock
4909	10" Pin Lock
*4910	24" Ball Lock (1/2" F x 3/8" M) Special Applications
49E18	18" Pin Lock
49E24	24" Pin Lock

*4910 - Commonly called Transmission Extension

Meets or exceeds ASME B107.110



4800



4422



4900



4902





6 Pt. Standard Sockets

Part No.	Nom. Size	Shape	L	Ds	Dd	Bd
4012	3/8"	I	1-1/2"	39/64"	7/8"	5/32"
4014	7/16"	I	1-1/2"	43/64"	7/8"	7/32"
4016	1/2"	I	1-1/2"	47/64"	7/8"	7/64"
4018	9/16"	I	1-1/2"	13/16"	7/8"	21/64"
4020	5/8"	II	1-1/2"	7/8"	-	21/64"
4022	11/16"	II	1-1/2"	63/64"	-	49/64"
4024	3/4"	II	1-1/2"	1-1/16"	-	3/4"
4026	13/16"	II	1-9/16"	1-1/8"	-	13/16"
4028	7/8"	II	1-5/8"	1-3/16"	-	55/64"
4030	15/16"	II	1-5/8"	1-9/32"	-	27/32"
4032	1"	II	1-11/16"	1-23/64"	-	7/8"
4034	1-1/16"	III	1-3/4"	1-7/16"	1-7/64"	29/32"
4036	1-1/8"	III	1-13/16"	1-1/2"	1-7/64"	15/16"
4038	1-3/16"	III	1-7/8"	1-19/32"	1-7/64"	63/64"
4040	1-1/4"	III	1-59/64"	1-21/32"	1-7/64"	1"
4042	1-5/16"	III	1-61/64"	1-13/16"	1-7/64"	1-1/64"
4044	1-3/8"	III	2"	1-7/8"	1-1/4"	1-3/64"
4046	1-7/16"	III	2-1/16"	1-61/64"	1-1/4"	1-3/32"
4048	1-1/2"	III	2-1/8"	2-1/64"	1-1/4"	1-1/8"



Meets or exceeds ASME B107.110

6 Pt. Deep Sockets

Part No.	Nom. Size	Shape	L	Ds	Dd	Bd
4512	3/8"	I	3-3/64"	39/64"	13/16"	5/32"
4514	7/16"	I	3-3/64"	11/16"	13/16"	7/32"
4516	1/2"	I	3-3/64"	47/64"	7/8"	17/64"
4518	9/16"	I	3-3/64"	13/16"	7/8"	21/64"
4520	5/8"	I	3-3/64"	7/8"	-	3/8"
4522	11/16"	II	3-3/64"	63/64"	-	2-11/32"
4524	3/4"	II	3-3/64"	1-1/16"	-	2-21/64"
4526	13/16"	II	3-3/64"	1-1/8"	-	2-19/64"
4528	7/8"	II	3-3/64"	1-3/16"	-	2-9/32"
4530	15/16"	II	3-3/64"	1-9/32"	-	2-17/64"
4532	1"	III	3-3/64"	1-23/64"	-	2-1/4"
4534	1-1/16"	III	3-3/64"	1-7/16"	1-7/64"	2-13/64"
4536	1-1/8"	III	3-3/64"	1-1/2"	1-7/64"	2-11/64"
4540	1-1/4"	III	3-3/64"	1-21/32"	1-7/64"	2-1/8"
4542	1-5/16"	III	3-3/64"	1-13/16"	1-7/64"	2-7/64"
4544	1-3/8"	III	3-3/64"	1-7/8"	1-1/4"	2-3/32"
4546	1-7/16"	III	3-3/64"	1-61/64"	1-1/4"	2-1/16"
4548	1-1/2"	III	3-3/64"	2-1/64"	1-1/4"	2-3/64"



Meets or exceeds ASME B107.110

Wright Drive® 6 Pt. & 12 Pt. design sockets and combination wrenches give ten times more fastener contact area than conventional designs.

Shape I

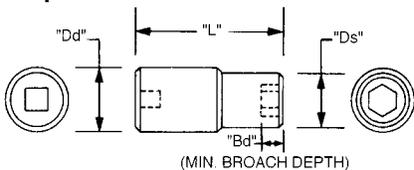

Shape II

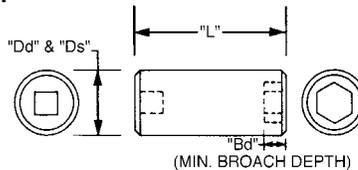

Shape III

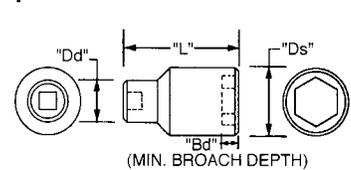

Sockets, Ratchets & Attachments





6 Pt. Spark Plug Holding Sockets

Part No.	Nom. Size	Shape	L	Ds	Dd	Bd
4590	5/8" Spark Plug Holding	III	2-1/2"	7/8"	-	3/16"
4596	13/16" Spark Plug Holding	III	2-5/8"	1-1/16"	7/8" hex	1/4"
4598	7/8" Spark Plug Holding	III	2-5/8"	1-3/16"	7/8" hex	5/32"

Meets or exceeds ASME B107.110



8 Pt. Standard Sockets

Part No.	Nom. Size	Shape	L	Ds	Dd	Bd
4312	3/8"	I	1-7/16"	47/64"	13/16"	5/32"
4314	7/16"	II	1-7/16"	13/16"	-	7/32"
4316	1/2"	II	1-7/16"	7/8"	-	17/64"
4318	9/16"	II	1-7/16"	31/32"	-	47/64"
4320	5/8"	II	1-7/16"	1-1/16"	-	23/32"
4322	11/16"	II	1-7/16"	1-3/16"	-	11/16"
4324	3/4"	II	1-15/32"	1-1/4"	-	11/16"
4326	13/16"	II	1-9/16"	1-5/16"	-	49/64"
4328	7/8"	III	1-3/4"	1-13/32"	1-7/64"	7/8"
4330	15/16"	III	1-7/8"	1-37/64"	1-7/64"	31/32"
4332	1"	III	1-15/16"	1-11/16"	1-7/64"	1"
4334	1-1/16"	III	1-15/16"	1-3/4"	1-7/64"	63/64"
4336	1-1/8"	III	2"	1-53/64"	1-1/4"	1-1/64"
4340	1-1/4"	III	2-1/8"	1-61/64"	1-1/4"	1-3/32"

Meets or exceeds ASME B107.110

1/2"



Sockets, Ratchets & Attachments





12 Pt. Standard Sockets



Part No.	Nom. Size	Shape	L	Ds	Dd	Bd
4112	3/8"	I	1-1/2"	39/64"	7/8"	5/32"
4114	7/16"	I	1-1/2"	43/64"	7/8"	7/32"
4116	1/2"	I	1-1/2"	47/64"	7/8"	17/64"
4118	9/16"	I	1-1/2"	13/16"	7/8"	21/64"
4119	19/32"	II	1-1/2"	55/64"	-	23/64"
4120	5/8"	II	1-1/2"	7/8"	-	3/8"
4121	21/32"	II	1-1/2"	15/16"	-	3/8"
4122	11/16"	II	1-1/2"	63/64"	-	49/64"
4124	3/4"	II	1-1/2"	1-1/16"	-	3/4"
4125	25/32"	II	1-1/2"	1-7/64"	-	49/64"
4126	13/16"	II	1-9/16"	1-1/8"	-	13/16"
4128	7/8"	II	1-5/8"	1-3/16"	-	55/64"
4129	29/32"	II	1-5/8"	1-7/32"	-	27/32"
4130	15/16"	II	1-5/8"	1-9/32"	-	27/32"
4131	31/32"	II	1-21/32"	1-19/64"	-	55/64"
4132	1"	II	1-21/32"	1-23/64"	-	27/32"
4134	1-1/16"	III	1-3/4"	1-7/16"	1-7/64"	29/32"
4136	1-1/8"	III	1-13/16"	1-1/2"	1-7/64"	15/16"
4138	1-3/16"	III	1-7/8"	1-19/32"	1-7/64"	63/64"
4140	1-1/4"	III	1-59/64"	1-21/32"	1-7/64"	1"
4142	1-5/16"	III	1-31/32"	1-13/16"	1-7/64"	1-1/64"
4144	1-3/8"	III	2"	1-7/8"	1-1/4"	1-3/64"
4146	1-7/16"	III	2-1/16"	1-61/64"	1-1/4"	1-3/32"
4148	1-1/2"	III	2-1/8"	2"	1-1/4"	1-1/8"

Meets or exceeds ASME B107.110

Wright Drive® 6 Pt. & 12 Pt. design sockets and combination wrenches give ten times more fastener contact area than conventional designs.

Shape I

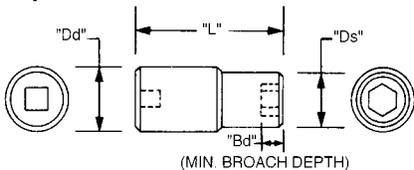

Shape II

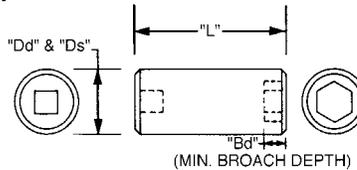

Shape III

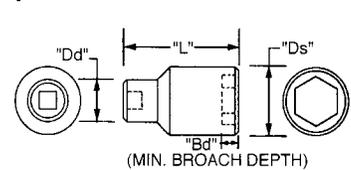

1/2"

Sockets, Ratchets & Attachments



12 Pt. Standard Metric Sockets

Part No.	Nom. Size	Shape	L	Ds	Dd	Bd
41-09mm	9mm	I	38.10	14.99	20.64	5.55
41-10mm	10mm	I	38.10	15.45	20.64	5.95
41-11mm	11mm	I	38.10	17.40	20.64	7.14
41-12mm	12mm	I	38.10	18.16	20.64	7.94
41-13mm	13mm	I	38.10	19.05	20.64	7.94
41-14mm	14mm	I	38.10	20.45	21.97	8.73
41-15mm	15mm	II	38.10	21.72	-	8.73
41-16mm	16mm	II	38.10	23.10	-	9.53
41-17mm	17mm	II	38.10	24.30	-	19.02
41-18mm	18mm	II	38.10	25.40	-	19.05
41-19mm	19mm	II	38.10	26.99	-	18.69
41-20mm	20mm	II	38.10	27.78	-	19.60
41-21mm	21mm	II	39.69	28.97	-	20.87
41-22mm	22mm	II	41.28	30.18	-	22.11
41-23mm	23mm	II	41.28	31.17	-	21.77
41-24mm	24mm	II	41.28	32.69	-	21.44
41-25mm	25mm	II	42.86	33.34	-	22.71
41-26mm	26mm	III	44.45	34.93	28.10	23.31
41-27mm	27mm	III	44.45	36.53	28.10	22.98
41-28mm	28mm	III	46.04	36.73	28.10	24.22
41-29mm	29mm	III	46.04	38.10	28.10	23.89
41-30mm	30mm	III	47.63	40.46	28.10	25.16
41-32mm	32mm	III	48.81	42.07	28.10	25.68
41-36mm	36mm	III	50.80	49.61	31.75	26.33

Meets or exceeds ASME B107.110

1/2"



Sockets, Ratchets & Attachments

Wright Drive® 6 Pt. & 12 Pt. design sockets and combination wrenches give ten times more fastener contact area than conventional designs.

Shape I

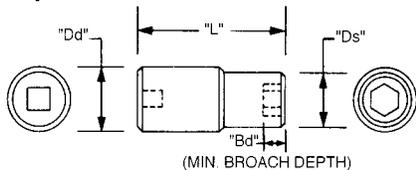

Shape II

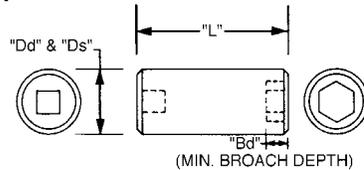

Shape III

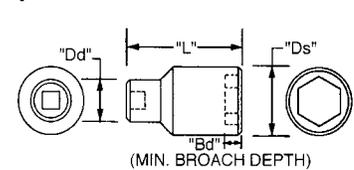

WARNING
Wear safety goggles user and bystander.



WARNING
Before using tools, read safety information on pages 399-403.



WARNING
Comfort or plastic grips do not protect against electric shock.



12 Pt. Deep Sockets

Part No.	Nom. Size	Shape	L	Ds	Dd	Bd
4612	3/8"	I	3-3/64"	39/64"	13/16"	37/64"
4614	7/16"	I	3-3/64"	11/16"	13/16"	23/32"
4616	1/2"	I	3-3/64"	47/64"	7/8"	17/64"
4618	9/16"	I	3-3/64"	13/16"	7/8"	21/64"
4620	5/8"	II	3-3/64"	7/8"	-	3/8"
4622	11/16"	II	3-3/64"	63/64"	-	2-11/32"
4624	3/4"	II	3-3/64"	1-1/16"	-	2-21/64"
4626	13/16"	II	3-3/64"	1-1/8"	-	2-19/64"
4628	7/8"	II	3-3/64"	1-3/16"	-	2-9/32"
4630	15/16"	II	3-3/64"	1-9/32"	-	2-17/64"
4632	1"	III	3-3/64"	1-23/64"	-	2-1/4"
4634	1-1/16"	III	3-3/64"	1-7/16"	1-7/64"	2-13/64"
4636	1-1/8"	III	3-3/64"	1-1/2"	1-7/64"	2-11/64"
4638	1-3/16"	III	3-3/64"	1-19/32"	1-7/64"	2-5/32"
4640	1-1/4"	III	3-3/64"	1-21/32"	1-7/64"	2-1/8"
4642	1-5/16"	III	3-3/64"	1-13/16"	1-7/64"	2-7/64"
4644	1-3/8"	III	3-3/64"	1-7/8"	1-1/4"	2-3/32"
4646	1-7/16"	III	3-3/64"	1-61/64"	1-1/4"	2-1/16"
4648	1-1/2"	III	3-3/64"	2-1/64"	1-1/4"	2-3/64"



Meets or exceeds ASME B107.110

12 Pt. Deep Metric Sockets

Part No.	Nom. Size	Shape	L	Ds	Dd	Bd
46-09mm	9mm	I	82.55	15.08	20.64	3.97
46-10mm	10mm	I	82.55	15.48	20.64	4.76
46-11mm	11mm	I	82.55	17.53	20.64	5.55
46-12mm	12mm	I	82.55	18.64	20.64	6.35
46-13mm	13mm	I	82.55	18.67	21.97	6.75
46-14mm	14mm	I	82.55	20.32	21.97	8.33
46-15mm	15mm	II	82.55	21.97	-	8.33
46-16mm	16mm	II	82.55	23.11	-	9.53
46-17mm	17mm	II	82.55	24.21	-	59.84
46-18mm	18mm	II	82.55	25.40	-	59.51
46-19mm	19mm	II	82.55	26.99	-	59.13
46-20mm	20mm	II	82.55	27.78	-	64.05
46-21mm	21mm	II	82.55	28.58	-	63.72
46-22mm	22mm	II	82.55	30.16	-	63.38
46-24mm	24mm	II	82.55	32.67	-	62.72
46-25mm	25mm	III	82.55	33.34	28.10	61.11
46-26mm	26mm	III	82.55	34.93	28.10	61.41



Meets or exceeds ASME B107.110

Wright Drive® 6 Pt. & 12 Pt. design sockets and combination wrenches give ten times more fastener contact area than conventional designs.

Shape I

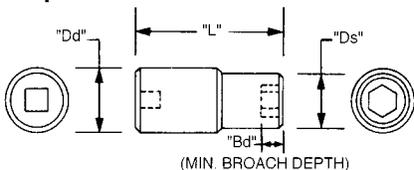

Shape II

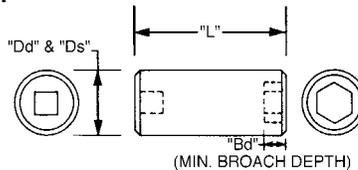

Shape III

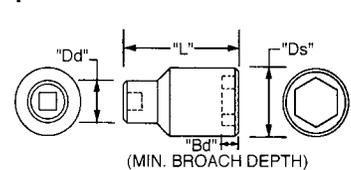



⑥ Pt. Standard Sockets

Black Industrial Finish

Part No.	Nom. Size	Shape	L	Ds	Dd	Bd
34012	3/8"	I	1-7/16"	39/64"	13/16"	5/32"
34014	7/16"	I	1-7/16"	11/16"	13/16"	7/32"
34016	1/2"	I	1-7/16"	3/4"	13/16"	7/64"
34018	9/16"	I	1-7/16"	53/64"	7/8"	21/64"
34020	5/8"	I	1-15/32"	29/32"	–	21/64"
34022	11/16"	II	1-15/32"	63/64"	–	49/64"
34024	3/4"	II	1-15/32"	1-1/16"	–	3/4"
34026	13/16"	II	1-9/16"	1-1/8"	–	13/16"
34028	7/8"	II	1-5/8"	1-3/16"	–	55/64"
34030	15/16"	II	1-5/8"	1-9/32"	–	27/32"
34032	1"	II	1-11/16"	1-23/64"	–	7/8"
34034	1-1/16"	III	1-3/4"	1-7/16"	1-7/64"	29/32"
34036	1-1/8"	III	1-13/16"	1-1/2"	1-7/64"	15/16"
34038	1-3/16"	III	1-7/8"	1-19/32"	1-7/64"	63/64"
34040	1-1/4"	III	1-59/64"	1-21/32"	1-7/64"	1"
34042	1-5/16"	III	1-61/64"	1-13/16"	1-7/64"	1-1/64"
34044	1-3/8"	III	2"	1-7/8"	1-1/4"	1-3/64"
34046	1-7/16"	III	2-1/16"	1-61/64"	1-1/4"	1-3/32"
34048	1-1/2"	III	2-1/8"	2-1/64"	1-1/4"	1-1/8"

For Hand Use Only
Meets or exceeds ASME B107.110



⑥ Pt. Deep Sockets

Black Industrial Finish

Part No.	Nom. Size	Shape	L	Ds	Dd	Bd
34514	7/16"	I	3-3/64"	11/16"	13/16"	7/32"
34516	1/2"	I	3-3/64"	3/4"	13/16"	17/64"
34518	9/16"	I	3-3/64"	53/64"	–	21/64"
34520	5/8"	II	3-3/64"	29/32"	–	3/8"
34522	11/16"	II	3-3/64"	63/64"	–	2-11/32"
34524	3/4"	II	3-3/64"	1-1/16"	–	2-21/64"
34526	13/16"	II	3-3/64"	1-1/8"	–	2-19/64"
34528	7/8"	II	3-3/64"	1-3/16"	–	2-9/32"
34530	15/16"	II	3-3/64"	1-9/32"	–	2-17/64"
34532	1"	III	3-3/64"	1-23/64"	–	2-1/4"
34534	1-1/16"	III	3-3/64"	1-7/16"	1-7/64"	2-13/64"
34536	1-1/8"	III	3-3/64"	1-1/2"	1-7/64"	2-11/64"
34540	1-1/4"	III	3-3/64"	1-21/32"	1-7/64"	2-1/8"

For Hand Use Only
Meets or exceeds ASME B107.110



Sockets, Ratchets & Attachments

Refer to socket dimensional drawings on page 182.





12 Pt. Standard Sockets

Black Industrial Finish

Part No.	Nom. Size	Shape	L	Ds	Dd	Bd
34112	3/8"	I	1-7/16"	39/64"	13/16"	5/32"
34114	7/16"	I	1-7/16"	11/16"	13/16"	7/32"
34116	1/2"	I	1-7/16"	3/4"	13/16"	17/64"
34118	9/16"	I	1-7/16"	53/64"	7/8"	21/64"
34120	5/8"	II	1-15/32"	29/32"	—	3/8"
34122	11/16"	II	1-15/32"	63/64"	—	49/64"
34124	3/4"	II	1-15/32"	1-1/16"	—	3/4"
34126	13/16"	II	1-9/16"	1-1/8"	—	13/16"
34128	7/8"	II	1-5/8"	1-3/16"	—	55/64"
34130	15/16"	II	1-5/8"	1-9/32"	—	27/32"
34132	1"	II	1-21/32"	1-23/64"	—	27/32"
34134	1-1/16"	III	1-3/4"	1-7/16"	1-7/64"	29/32"
34136	1-1/8"	III	1-13/16"	1-1/2"	1-7/64"	15/16"
34138	1-3/16"	III	1-7/8"	1-19/32"	1-7/64"	63/64"
34140	1-1/4"	III	1-59/64"	1-21/32"	1-7/64"	1"
34142	1-5/16"	III	1-31/32"	1-13/16"	1-7/64"	1-1/64"
34144	1-3/8"	III	2"	1-7/8"	1-1/4"	1-3/64"
34146	1-7/16"	III	2-1/16"	1-61/64"	1-1/4"	1-3/32"
34148	1-1/2"	III	2-1/8"	2"	1-1/4"	1-1/8"



For Hand Use Only
 Meets or exceeds ASME B107.110

12 Pt. Deep Sockets

Black Industrial Finish

Part No.	Nom. Size	Shape	L	Ds	Dd	Bd
34612	3/8"	I	3-3/64"	39/64"	13/16"	37/64"
34614	7/16"	I	3-3/64"	11/16"	13/16"	23/32"
34616	1/2"	I	3-3/64"	3/4"	13/16"	17/64"
34618	9/16"	II	3-3/64"	53/64"	—	21/64"
34620	5/8"	II	3-3/64"	29/32"	—	3/8"
34622	11/16"	II	3-3/64"	63/64"	—	2-11/32"
34624	3/4"	II	3-3/64"	1-1/16"	—	2-21/64"
34626	13/16"	II	3-3/64"	1-1/8"	—	2-19/64"
34628	7/8"	II	3-3/64"	1-3/16"	—	2-9/32"
34630	15/16"	II	3-3/64"	1-9/32"	—	2-17/64"
34632	1"	II	3-3/64"	1-23/64"	—	2-1/4"
34634	1-1/16"	III	3-3/64"	1-7/16"	1-7/64"	2-13/64"
34636	1-1/8"	III	3-3/64"	1-1/2"	1-7/64"	2-11/64"
34638	1-3/16"	III	3-3/64"	1-19/32"	1-7/64"	2-5/32"
34640	1-1/4"	III	3-3/64"	1-21/32"	1-7/64"	2-1/8"
34642	1-5/16"	III	3-3/64"	1-13/16"	1-7/64"	2-7/64"
34644	1-3/8"	III	3-3/64"	1-7/8"	1-1/4"	2-3/32"
34646	1-7/16"	III	3-3/64"	1-61/64"	1-1/4"	1-1/16"
34648	1-1/2"	III	3-3/64"	2-1/64"	1-1/4"	2-3/64"



For Hand Use Only
 Meets or exceeds ASME B107.110

Refer to socket dimensional drawings on page 185.

Wright Drive® 6 Pt. & 12 Pt. design sockets and combination wrenches give ten times more fastener contact area than conventional designs.

1/2"



Sockets, Ratchets & Attachments





8 Pt. (Double Square) Deep Impact Sockets

Part No.	Nom. Size	Shape	L	Ds	Dd	Bd
4772	3/8"	I	3-1/4"	47/64"	15/16"	5/32"
4774	7/16"	I	3-1/4"	13/16"	31/32"	7/32"
4776	1/2"	II	3-1/4"	-	31/32"	17/64"
4778	9/16"	II	3-1/4"	-	1-1/32"	21/64"
4780	5/8"	II	3-1/4"	-	1-5/32"	2-33/64"
4782	11/16"	II	3-1/4"	-	1-1/4"	2-1/2"
4784	3/4"	II	3-1/4"	-	1-5/16"	2-15/32"
4786	13/16"	II	3-1/4"	-	1-3/8"	2-29/64"
4788	7/8"	III	3-1/2"	1-9/16"	1-3/8"	2-5/8"
4790	15/16"	III	3-1/2"	1-5/8"	1-3/8"	2-19/32"
4792	1"	III	3-1/2"	1-3/4"	1-3/8"	2-37/64"
4794	1-1/16"	III	3-1/2"	1-27/32"	1-5/8"	2-35/64"
4796	1-1/8"	III	3-1/2"	2"	1-13/32"	2-33/64"

Meets or exceeds ASME B107.110



6 Pt. Standard Impact Sockets

Part No.	Nom. Size	Shape	L	Ds	Dd	Bd
4812	3/8"	I	1-15/32"	21/32"	15/16"	5/32"
4814	7/16"	I	1-15/32"	23/32"	15/16"	7/32"
4816	1/2"	I	1-15/32"	51/64"	15/16"	7/64"
4818	9/16"	I	1-15/32"	7/8"	15/16"	21/64"
4820	5/8"	II	1-15/32"	1"	-	21/64"
4822	11/16"	II	1-15/32"	1-1/16"	-	49/64"
4824	3/4"	II	1-1/2"	1-5/32"	-	25/32"
4826	13/16"	II	1-9/16"	1-15/64"	-	53/64"
4828	7/8"	II	1-5/8"	1-5/16"	-	55/64"
4830	15/16"	II	1-11/16"	1-25/64"	-	29/32"
4832	1"	II	1-23/32"	1-7/16"	-	59/64"
4834	1-1/16"	III	1-3/4"	1-1/2"	1-3/8"	29/32"
4836	1-1/8"	III	1-13/16"	1-5/8"	1-3/8"	15/16"
4838	1-3/16"	III	1-7/8"	1-11/16"	1-3/8"	63/64"
4840	1-1/4"	III	1-15/16"	1-3/4"	1-3/8"	1-1/32"
4842	1-5/16"	III	2"	2-1/64"	1-3/8"	1-1/16"
4844	1-3/8"	III	2-1/16"	2-1/16"	1-17/32"	1-1/8"
4846	1-7/16"	III	2-1/8"	2-5/32"	1-17/32"	1-5/32"
4848	1-1/2"	III	2-3/16"	2-15/64"	1-17/32"	1-3/16"

Meets or exceeds ASME B107.110



Shape I

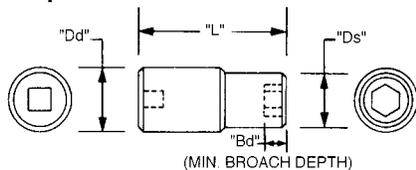

Shape II

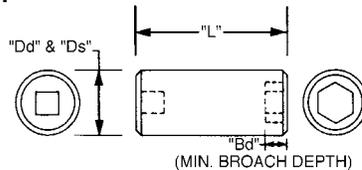

Shape III

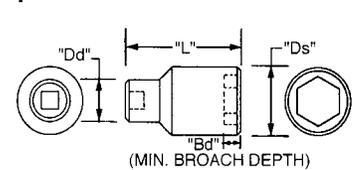



12 Pt. Standard Impact Socket

Part No.	Nom. Size	Shape	L	Ds	Dd	Bd
4864	7/16"	I	1-15/32"	47/64"	15/16"	7/32"
4866	1/2"	I	1-15/32"	13/16"	15/16"	17/64"
4868	9/16"	II	1-15/32"	15/16"	-	21/64"
4870	5/8"	II	1-15/32"	1"	-	3/8"
4872	11/16"	II	1-15/32"	1-1/16"	-	49/64"
4874	3/4"	II	1-15/32"	1-5/32"	-	3/4"
4876	13/16"	II	1-9/16"	1-15/64"	-	53/64"
4878	7/8"	II	1-5/8"	1-5/16"	-	55/64"
4880	15/16"	II	1-11/16"	1-25/64"	-	29/32"
4882	1"	II	1-23/32"	1-7/16"	-	59/64"
4884	1-1/16"	III	1-3/4"	1-1/2"	1-3/8"	29/32"
4886	1-1/8"	III	1-13/16"	1-5/8"	1-3/8"	15/16"
4888	1-3/16"	III	1-7/8"	1-11/16"	1-3/8"	63/64"
4890	1-1/4"	III	1-15/16"	1-3/4"	1-3/8"	1-1/32"
4892	1-5/16"	III	2"	2-1/64"	1-3/8"	1-1/16"
4894	1-3/8"	III	2-1/16"	2-1/16"	1-17/32"	1-1/8"
4896	1-7/16"	III	2-1/8"	2-5/32"	1-17/32"	1-5/32"
4898	1-1/2"	III	2-3/16"	2-15/64"	1-17/32"	1-3/16"



Meets or exceeds ASME B107.110

6 Pt. Standard Impact Metric Sockets

Part No.	Nom. Size	Shape	L	Ds	Dd	Bd
48-10mm	10mm	I	37.30	17.06	23.81	7.94
48-11mm	11mm	I	37.30	18.25	23.81	7.14
48-12mm	12mm	I	37.30	19.45	23.81	8.33
48-13mm	13mm	I	37.30	20.64	23.81	16.67
48-14mm	14mm	I	37.30	22.23	24.60	10.32
48-15mm	15mm	I	37.30	24.93	-	10.32
48-16mm	16mm	II	37.30	24.93	-	11.90
48-17mm	17mm	II	37.30	26.59	-	19.84
48-18mm	18mm	II	38.10	27.89	-	20.27
48-19mm	19mm	II	38.10	29.37	-	20.27
48-20mm	20mm	II	39.69	30.16	-	21.20
48-21mm	21mm	II	39.69	31.75	-	20.87
48-22mm	22mm	II	41.28	32.71	-	22.11
48-23mm	23mm	II	42.86	33.34	-	23.37
48-24mm	24mm	II	42.86	35.30	-	23.04
48-25mm	25mm	II	43.65	36.51	-	23.52
48-26mm	26mm	III	44.45	38.10	34.93	23.35
48-27mm	27mm	III	44.45	38.10	34.93	22.98
48-28mm	28mm	III	46.04	41.28	34.93	24.25
48-30mm	30mm	III	47.63	42.86	34.93	25.16
48-32mm	32mm	III	49.21	44.45	34.93	26.09
48-36mm	36mm	III	53.98	52.39	38.88	29.51



Meets or exceeds ASME B107.110

Shape I

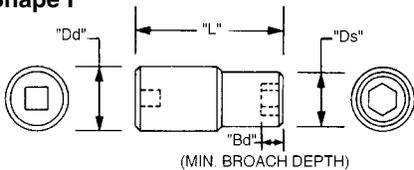

Shape II

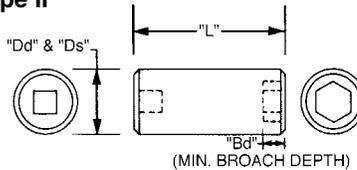

Shape III

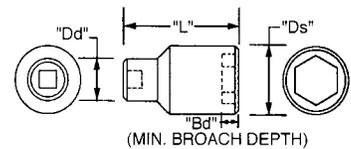

1/2"



Sockets, Ratchets & Attachments



6 Pt. Deep Impact Sockets

Part No.	Nom. Size	Shape	L	Ds	Dd	Bd
4912	3/8"	I	3-1/4"	21/32"	15/16"	5/32"
4914	7/16"	I	3-1/4"	23/32"	15/16"	7/32"
4916	1/2"	I	3-1/4"	51/64"	15/16"	17/64"
4918	9/16"	I	3-1/4"	7/8"	31/32"	21/64"
4920	5/8"	II	3-1/4"	1"	-	3/8"
4922	11/16"	II	3-1/4"	1-1/16"	-	2-35/64"
4924	3/4"	II	3-1/4"	1-5/32"	-	2-17/32"
4926	13/16"	II	3-1/4"	1-15/64"	-	2-1/2"
4928	7/8"	II	3-1/4"	1-5/16"	-	2-3/4"
4930	15/16"	II	3-1/4"	1-3/8"	-	2-27/32"
4932	1"	II	3-1/2"	1-7/16"	-	2-45/64"
4934	1-1/16"	III	3-1/2"	1-1/2"	1-3/8"	2-21/32"
4936	1-1/8"	III	3-1/2"	1-5/8"	1-3/8"	2-5/8"
*4938	1-3/16"	III	3-1/2"	1-3/4"	1-3/8"	2-19/32"
4940	1-1/4"	III	3-1/2"	1-3/4"	1-3/8"	2-19/32"
4942	1-5/16"	III	3-5/8"	2-1/64"	1-3/8"	2-9/16"
4944	1-3/8"	III	3-5/8"	2-1/16"	1-17/32"	2-35/64"
4946	1-7/16"	III	3-5/8"	2-5/32"	1-17/32"	2-17/32"
4948	1-1/2"	III	3-5/8"	2-15/64"	1-17/32"	2-1/2"

*Not recommended for Dayton wheel use
Meets or exceeds ASME B107.110

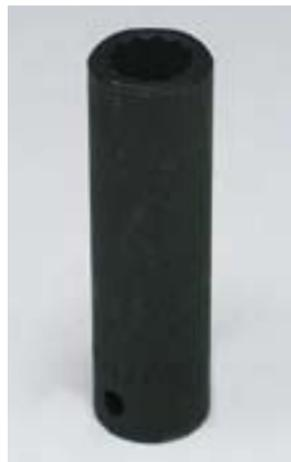

12 Pt. Deep Impact Sockets

Part No.	Nom. Size	Shape	L	Ds	Dd	Bd
4964	7/16"	I	3-1/4"	47/64"	15/16"	7/32"
4966	1/2"	I	3-1/4"	13/16"	15/16"	17/64"
4968	9/16"	II	3-1/4"	15/16"	-	21/64"
4970	5/8"	II	3-1/4"	1"	-	3/8"
4972	11/16"	II	3-1/4"	1-1/16"	-	3/8"
4974	3/4"	II	3-1/4"	1-5/32"	-	2-1/2"
4976	13/16"	II	3-1/4"	1-15/64"	-	2-1/2"
4978	7/8"	II	3-1/4"	1-5/16"	-	2-3/4"
4980	15/16"	II	3-1/4"	1-3/8"	-	2-27/32"
4982	1"	II	3-1/2"	1-7/16"	-	2-45/64"
4984	1-1/16"	III	3-1/2"	1-1/2"	1-3/8"	2-21/32"
4986	1-1/8"	III	3-1/2"	1-5/8"	1-3/8"	2-5/8"
4988	1-3/16"	III	3-1/2"	1-3/4"	1-3/8"	2-19/32"
4990A	1-1/4"	III	3-1/2"	1-3/4"	1-3/8"	2-19/32"
4992	1-5/16"	III	3-5/8"	2-1/64"	1-3/8"	2-9/16"
4994	1-3/8"	III	3-5/8"	2-1/16"	1-17/32"	2-35/64"
4996	1-7/16"	III	3-5/8"	2-5/32"	1-17/32"	2-17/32"
4998	1-1/2"	III	3-5/8"	2-15/64"	1-17/32"	2-1/2"

Meets or exceeds ASME B107.110

Shape I

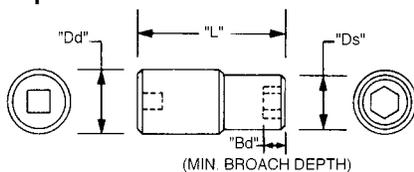

Shape II

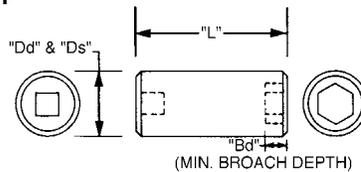

Shape III

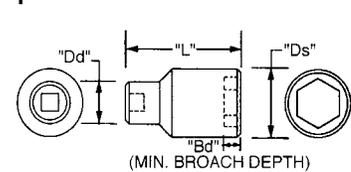



⑥ Pt. Deep Metric Impact Sockets

Part No.	Nom. Size	Shape	L	Ds	Dd	Bd
49-10mm	10mm	I	82.55	17.06	23.81	7.94
49-11mm	11mm	I	82.55	18.26	23.81	7.14
49-12mm	12mm	I	82.55	19.86	23.81	8.33
49-13mm	13mm	I	82.55	20.64	23.81	8.33
49-14mm	14mm	I	82.55	22.23	24.60	10.32
49-15mm	15mm	II	82.55	24.60	-	10.32
49-16mm	16mm	II	82.55	25.40	-	11.90
49-17mm	17mm	II	82.55	26.59	-	12.29
49-18mm	18mm	II	82.55	27.76	-	64.72
49-19mm	19mm	II	82.55	29.36	-	64.05
49-20mm	20mm	II	82.55	30.16	-	63.72
49-21mm	21mm	II	82.55	31.75	-	63.38
49-22mm	22mm	II	82.55	32.54	-	69.40
49-23mm	23mm	II	82.55	34.14	-	69.07
49-24mm	24mm	II	88.90	35.31	-	68.73
49-27mm	27mm	III	88.90	38.10	34.93	67.43
49-29mm	29mm	III	88.90	41.26	34.93	66.76
49-30mm	30mm	III	88.90	42.88	34.93	66.43
49-31mm	31mm	III	88.90	44.45	34.93	66.43
49-32mm	32mm	III	88.90	44.45	34.93	65.76
49-34mm	34mm	III	88.90	51.18	34.93	65.10
49-35mm	35mm	III	88.90	52.37	38.88	64.76
49-36mm	36mm	III	88.90	52.37	38.88	64.43

Meets or exceeds ASME B107.110

“Flip” Socket

Part No.	Nom. Size	Shape	L	Ds	Dd	Bd
4990	3/4" x 13/16"	-	2-1/4"	1-1/4"	-	-
“Flip” Socket for Wheel Lug Nuts						

Meets or exceeds ASME B107.110

Metric “Flip” Socket

Part No.	Nom. Size	Shape	L	Ds	Dd	Bd
48-91mm	19mm x 21mm	-	2-1/4"	1-1/4"	-	-
“Flip” Socket for Wheel Lug Nuts						

Meets or exceeds ASME B107.110



Refer to socket dimensional drawings on page 187.



1/2"

Sockets, Ratchets & Attachments



5 Pt. Black Penta Socket

Part No.	Nom. Size	Shape	L	Ds	Dd	Bd
9076	13/16 5 Pt. Socket	II	2"	1-1/8"	-	13/16"



Meets or exceeds ASME B107.110

Hex Bit Sockets & Replacement Hex Bits

Part No.	Nom. Size	Shape	L	Ds	Dd	L1	Replacement Bit Part No.	Bit Length
4208	1/4"	III	2-7/32"	21/32"	15/16"	11/16"	3208B	1-1/2"
4210	5/16"	III	2-7/32"	43/64"	15/16"	11/16"	3210B	1-1/2"
4212	3/8"	III	2-7/16"	45/64"	15/16"	15/16"	4212B	1-1/2"
4214	7/16"	III	2-7/16"	3/4"	15/16"	15/16"	4214B	1-1/2"
4216	1/2"	IV	2-7/16"	15/16"	-	15/16"	4216B	1-1/2"
4218	9/16"	IV	2-7/16"	1-1/32"	-	15/16"	4218B	1-1/2"
4220	5/8"	IV	2-7/16"	1-1/32"	-	15/16"	4220B	1-1/2"

Meets or exceeds ASME B107.110

Metric Hex Bit Sockets & Replacement Hex Bits

Part No.	Nom. Size	Shape	L	Ds	Dd	L1	Replacement Bit Part No.	Bit Length
42-06mm	6mm	III	56.00	16.94	23.78	17.22	32M06B	38.10
42-08mm	8mm	III	56.00	16.94	23.78	18.00	32M08B	38.10
42-10mm	10mm	III	62.00	19.00	23.78	24.38	42M10B	38.10
42-12mm	12mm	III	62.00	23.78	23.78	24.38	42M12B	38.10
42-14mm	14mm	II	62.00	26.00	-	24.38	42M14B	38.10
42-17mm	17mm	II	62.00	27.80	-	24.38	42M17B	38.10

Meets or exceeds ASME B107.110

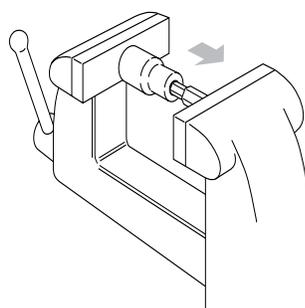

The design allows easy replacement of a broken bit. After driving out the remaining piece, simply press the new bit in using a bench vise.

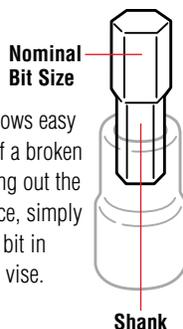

Replacement Hex Bits

Shape II

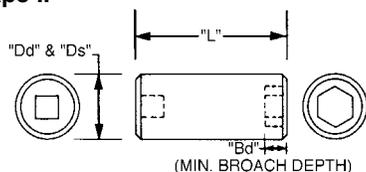

Shape III

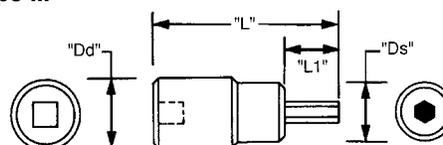



Long Length Hex Bit Sockets & Replacement Hex Bits

Part No.	Nom. Size	Shape	L	Ds	Dd	L1	Replacement Bit Part No.	Bit Length
42L08	1/4"	III	6-1/2"	43/64"	15/16"	5"	42L08B	5-1/2"
42L10	5/16"	III	6-1/2"	43/64"	15/16"	5"	42L10B	5-1/2"
42L12	3/8"	III	6-1/2"	45/64"	15/16"	5"	42L12B	5-1/2"
42L14	7/16"	III	6-1/2"	3/4"	15/16"	5"	42L14B	5-1/2"
42L16	1/2"	IV	6-1/2"	15/16"	-	5"	42L16B	5-1/2"
42L18	9/16"	IV	6-1/2"	1-1/32"	-	5"	42L18B	5-1/2"
42L20	5/8"	IV	6-1/2"	1-1/32"	-	5"	42L20B	5-1/2"

Meets or exceeds ASME B107.110

Long Length Metric Hex Bit Sockets & Replacement Hex Bits

Part No.	Nom. Size	Shape	L	Ds	Dd	L1	Replacement Bit Part No.	Bit Length
42L-06mm	6mm	III	165.00	16.94	23.78	127.00	42L-06MMB	139.70
42L-08mm	8mm	III	165.00	16.94	23.78	127.00	42L-08MMB	139.70
42L-10mm	10mm	III	165.00	19.00	23.78	127.00	42L-10MMB	139.70
42L-12mm	12mm	IV	165.00	23.78	-	127.00	42L-12MMB	139.70
42L-14mm	14mm	IV	165.00	26.00	-	127.00	42L-14MMB	139.70
42L-17mm	17mm	IV	165.00	28.00	-	127.00	42L-17MMB	139.70

Meets or exceeds ASME B107.110

Shape III

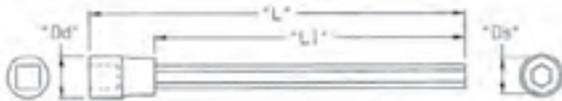

Shape IV



Impact Hex Bit Sockets & Replacement Hex Bits

Part No.	Nom. Size	L	Dd	L1	Bit Length	Replacement Bit Part No.
42B08	1/4"	2-7/16"	15/16"	15/16"	1-1/2"	42B08B
42B10	5/16"	2-7/16"	15/16"	15/16"	1-1/2"	42B10B
42B12	3/8"	2-7/16"	15/16"	15/16"	1-1/2"	42B12B
42B14	7/16"	2-7/16"	15/16"	15/16"	1-1/2"	42B14B
42B16	1/2"	2-5/8"	1-1/16"	1"	1-5/8"	42B16B
42B18	9/16"	2-5/8"	1-1/16"	1"	1-5/8"	42B18B
42B20	5/8"	2-5/8"	1-1/16"	1"	1-5/8"	42B20B

Meets or exceeds ASME B107.110

Impact Hex Metric Bit Sockets & Replacement Hex Bits

Part No.	Nom. Size	L	Dd	L1	Bit Length	Replacement Bit Part No.
42B-06MM	6mm	61.98	23.62	23.88	38.10	42BM06B
42B-08MM	8mm	61.98	23.62	23.88	38.10	42BM08B
42B-10MM	10mm	61.98	23.62	23.88	38.10	42BM10B
42B-12MM	12mm	66.68	26.80	25.40	41.28	42BM12B
42B-14MM	14mm	66.68	26.80	25.40	41.28	42BM14B
42B-17MM	17mm	66.68	26.80	25.40	41.28	42BM17B

Meets or exceeds ASME B107.110

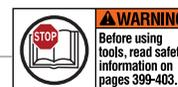
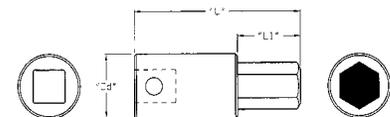

1/2"

Sockets, Ratchets & Attachments



9287



9288

Torx Bits

Part No.	Hex Size	Shape	Bit Size	L
9287	7/16"	I	T-55	1-1/2"
9288	1/2" Sq. Drive	II	T-60	2-1/8"

Meets or exceeds ASME B107.110



Torx Bit Holders

Part No.	Description	Shape	Dr. Sq. Size	Hex Size	L	Ds	Dd
9291	1/2" Dr. 7/16" Hex Bit Holder	III	1/2"	7/16"	1-1/2"	7/8"	11/16"

Meets or exceeds ASME B107.110

1/2"



Sockets, Ratchets & Attachments

Shape I

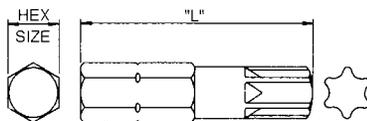

Shape II

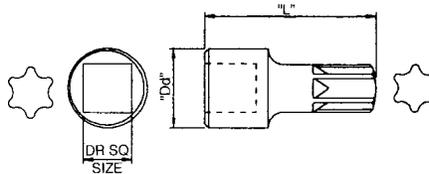

Shape III

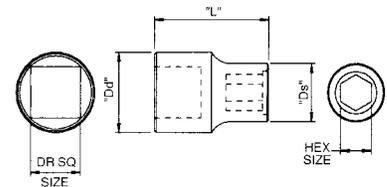

WARNING
Wear safety goggles user and bystander.



WARNING
Before using tools, read safety information on pages 399-403.



WARNING
Comfort or plastic grips do not protect against electric shock.



WARNING
Hand use only. Not for impact use.



We Have The

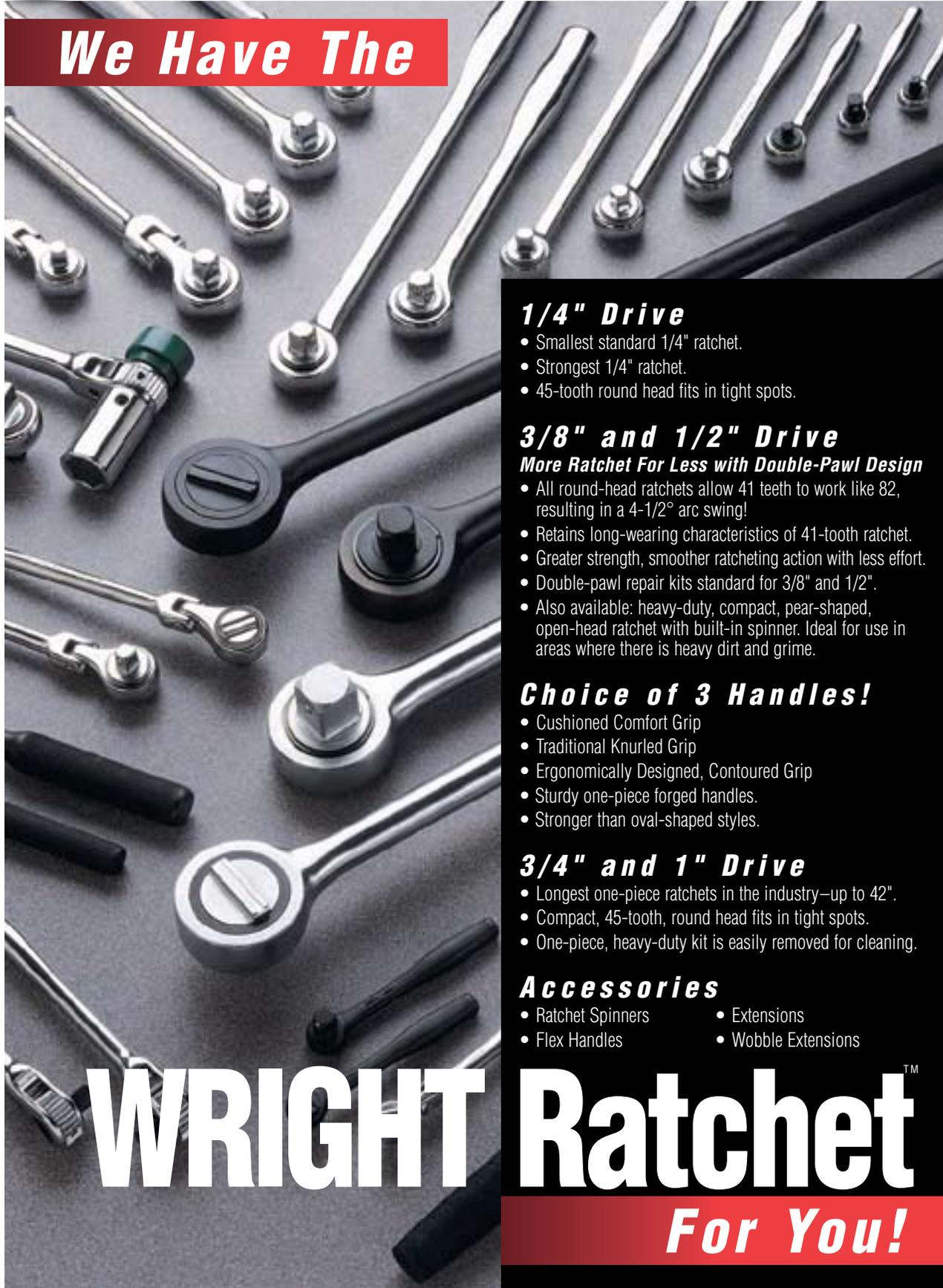

1/2"



Sockets, Ratchets & Attachments

1/4" Drive

- Smallest standard 1/4" ratchet.
- Strongest 1/4" ratchet.
- 45-tooth round head fits in tight spots.

3/8" and 1/2" Drive

More Ratchet For Less with Double-Pawl Design

- All round-head ratchets allow 41 teeth to work like 82, resulting in a 4-1/2° arc swing!
- Retains long-wearing characteristics of 41-tooth ratchet.
- Greater strength, smoother ratcheting action with less effort.
- Double-pawl repair kits standard for 3/8" and 1/2".
- Also available: heavy-duty, compact, pear-shaped, open-head ratchet with built-in spinner. Ideal for use in areas where there is heavy dirt and grime.

Choice of 3 Handles!

- Cushioned Comfort Grip
- Traditional Knurled Grip
- Ergonomically Designed, Contoured Grip
- Sturdy one-piece forged handles.
- Stronger than oval-shaped styles.

3/4" and 1" Drive

- Longest one-piece ratchets in the industry—up to 42".
- Compact, 45-tooth, round head fits in tight spots.
- One-piece, heavy-duty kit is easily removed for cleaning.

Accessories

- Ratchet Spinners
- Extensions
- Flex Handles
- Wobble Extensions

WRIGHT Ratchet™

For You!





31 Pieces – 12 Pt. Standard Socket Set Set No. 631

Part No.	Description	Part No.	Description
6128	7/8"	6160	1-7/8"
6130	15/16"	6164	2"
6132	1"	6166	2-1/16"
6134	1-1/16"	6168	2-1/8"
6136	1-1/8"	6170	2-3/16"
6138	1-3/16"	6172	2-1/4"
6140	1-1/4"	6176	2-3/8"
6142	1-5/16"	6400	Ratchet
6144	1-3/8"	6403	3-1/2" Extension
6146	1-7/16"	6408	8" Extension
6148	1-1/2"	6416	16" Extension
6150	1-9/16"	6435	Flex Handle
6152	1-5/8"	6440	Bull Bar
6154	1-11/16"	6443	Sliding T
6156	1-3/4"	6475	Universal
6158	1-13/16"	237	Metal Box



22 Pieces – 12 Pt. Standard Socket Set Set No. 623

Part No.	Description	Part No.	Description
6128	7/8"	6152	1-5/8"
6130	15/16"	6154	1-11/16"
6132	1"	6156	1-3/4"
6134	1-1/16"	6158	1-13/16"
6136	1-1/8"	6160	1-7/8"
6138	1-3/16"	6164	2"
6140	1-1/4"	6400	Ratchet
6142	1-5/16"	6403	3-1/2" Extension
6144	1-3/8"	6408	8" Extension
6146	1-7/16"	6443	Sliding T
6148	1-1/2"	237	Metal Box
6150	1-9/16"		

3/4"



Sockets, Ratchets & Attachments





**19 Pieces – 12 Pt. Standard Socket Set
 Set No. 618**

Part No.	Description	Part No.	Description
6128	7/8"	6152	1-5/8"
6130	15/16"	6154	1-11/16"
6132	1"	6156	1-3/4"
6134	1-1/16"	6158	1-13/16"
6136	1-1/8"	6160	1-7/8"
6140	1-1/4"	6164	2"
6142	1-5/16"	6400	Ratchet
6144	1-3/8"	6408	8" Extension
6146	1-7/16"	6435	Flex Handle
6148	1-1/2"	237	Metal Box



**13 Pieces – 12 Pt. Standard Socket Set
 Set No. 614**

Part No.	Description	Part No.	Description
6128	7/8"	6144	1-3/8"
6130	15/16"	6146	1-7/16"
6132	1"	6148	1-1/2"
6134	1-1/16"	6152	1-5/8"
6136	1-1/8"	6400	Ratchet
6140	1-1/4"	6408	8" Extension
6142	1-5/16"	96A	Metal Box



**13 Pieces – 6 Pt. Deep Socket Set
 Set No. 625**

Part No.	Description	Part No.	Description
6524	3/4"	6538	1-3/16"
6526	13/16"	6540	1-1/4"
6528	7/8"	6542	1-5/16"
6530	15/16"	6544	1-3/8"
6532	1"	6546	1-7/16"
6534	1-1/16"	6548	1-1/2"
6536	1-1/8"	23	Metal Box



3/4"



Sockets, Ratchets & Attachments





31 Pieces – 12 Pt. Standard Metric Socket Set Set No. 650

Part No.	Description	Part No.	Description
61-19mm	19mm	61-41mm	41mm
61-21mm	21mm	61-42mm	42mm
61-22mm	22mm	61-46mm	46mm
61-23mm	23mm	61-50mm	50mm
61-24mm	24mm	61-54mm	54mm
61-25mm	25mm	61-55mm	55mm
61-26mm	26mm	61-58mm	58mm
61-27mm	27mm	61-60mm	60mm
61-28mm	28mm	6400	3/4" Drive Ratchet
61-29mm	29mm	6403	3-1/2" Extension
61-30mm	30mm	6408	8" Extension
61-31mm	31mm	6416	16" Extension
61-32mm	32mm	6435	3/4" Drive Flex Handle
61-35mm	35mm	6443	Sliding T
61-36mm	36mm	6475	Universal
61-38mm	38mm	237	Metal Box



24 Pieces – 12 Pt. Standard Metric Socket Set Set No. 624

Part No.	Description	Part No.	Description
61-19mm	19mm	61-35mm	35mm
61-21mm	21mm	61-36mm	36mm
61-22mm	22mm	61-38mm	38mm
61-23mm	23mm	61-41mm	41mm
61-24mm	24mm	61-42mm	42mm
61-25mm	25mm	61-46mm	46mm
61-26mm	26mm	61-50mm	50mm
61-27mm	27mm	61-54mm	54mm
61-28mm	28mm	61-55mm	55mm
61-29mm	29mm	61-58mm	58mm
61-30mm	30mm	61-60mm	60mm
61-31mm	31mm		Cardboard Carton
61-32mm	32mm		



9 Pieces – 12 Pt. Impact Socket Set Set No. 603

Part No.	Description	Part No.	Description
67H24	3/4"	67H34	1-1/16"
67H26	13/16"	67H36	1-1/8"
67H28	7/8"	67H38	1-3/16"
67H30	15/16"	67H40	1-1/4"
67H32	1"		Cardboard Carton





**11 Pieces – 12 Pt. Impact Socket Set
 Set No. 604**

Part No.	Description	Part No.	Description
67H42	1-5/16"	67H54	1-11/16"
67H44	1-3/8"	67H56	1-3/4"
67H46	1-7/16"	67H58	1-13/16"
67H48	1-1/2"	67H60	1-7/8"
67H50	1-9/16"	67H64	2"
67H52	1-5/8"		Cardboard Carton



**9 Pieces – 6 Pt. Standard Impact
 Socket Set
 Set No. 609**

Part No.	Description	Part No.	Description
6824	3/4"	6834	1-1/16"
6826	13/16"	6836	1-1/8"
6828	7/8"	6838	1-3/16"
6830	15/16"	6840	1-1/4"
6832	1"		Cardboard Carton



**14 Pieces – 6 Pt. Standard Impact
 Socket Set
 Set No. 610**

Part No.	Description	Part No.	Description
6824	3/4"	6840	1-1/4"
6826	13/16"	6842	1-5/16"
6828	7/8"	6844	1-3/8"
6830	15/16"	6846	1-7/16"
6832	1"	6848	1-1/2"
6834	1-1/16"	6852	1-5/8"
6836	1-1/8"	22	Metal Box
6838	1-3/16"		



3/4"



Sockets, Ratchets & Attachments





8 Pieces – 6 Pt. Deep Impact Socket Set Set No. 608

Part No.	Description	Part No.	Description
6928	7/8"	6940	1-1/4"
6930	15/16"	6942	1-5/16"
6932	1"	6948	1-1/2"
6934	1-1/16"	Cardboard Carton	
6936	1-1/8"		



5 Pieces – Impact Hex Bit Socket Set Set No. 606

Part No.	Description	Part No.	Description
6218	9/16"	6228	7/8"
6220	5/8"	6232	1"
6224	3/4"	Cardboard Carton	

3/4"



Sockets, Ratchets & Attachments





**5 Pieces – Metric Impact Hex Bit
 Socket Set
 Set No. 607**

Part No.	Description	Part No.	Description
62-14mm	14mm	62-22mm	22mm
62-17mm	17mm	62-24mm	24mm
62-19mm	19mm		Cardboard Carton



**19 Pieces – ⑥ 6 Pt. Standard Metric
 Impact Socket Set
 Set No. 655**

Part No.	Description	Part No.	Description
68-17mm	17mm	68-29mm	29mm
68-19mm	19mm	68-30mm	30mm
68-20mm	20mm	68-32mm	32mm
68-21mm	21mm	68-33mm	33mm
68-22mm	22mm	68-34mm	34mm
68-23mm	23mm	68-35mm	35mm
68-24mm	24mm	68-36mm	36mm
68-26mm	26mm	68-38mm	38mm
68-27mm	27mm	68-41mm	41mm
68-28mm	28mm		Cardboard Box



3/4"



Sockets, Ratchets & Attachments



3/4" Drive Impact Socket Sets

WRIGHT TOOL
PERFECTING PERFORMANCE

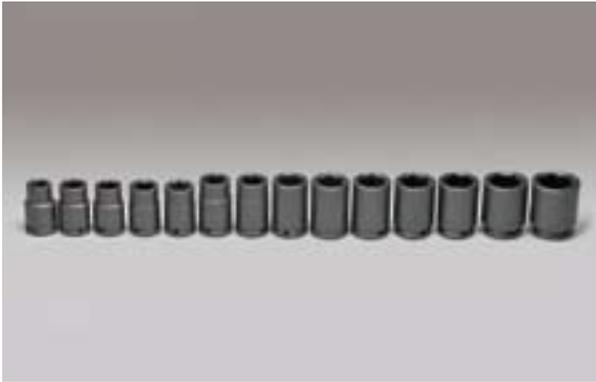

14 Pieces – 6 Pt. Deep Metric Impact Socket Set Set No. 660

Part No.	Description	Part No.	Description
69-19mm	19mm	69-32mm	32mm
69-21mm	21mm	69-33mm	33mm
69-22mm	22mm	69-35mm	35mm
69-23mm	23mm	69-36mm	36mm
69-24mm	24mm	69-38mm	38mm
69-26mm	26mm	69-41mm	41mm
69-27mm	27mm		Cardboard Box
69-30mm	30mm		

3/4"



Sockets, Ratchets & Attachments





Ratchets

Drop forged, one-piece handle. Handle design allows operator to "feel" the fastener. Precision machined 45 tooth head gives long life and short arc swing. Kit is easily removed for cleaning or replacement.

Part No.	Description	Overall Length
6400	Knurled Steel Handle	24"
36400	Black Knurled Steel Handle	24"
6425	Long Black Knurled Steel Handle	42"

Meets or exceeds ASME B107.110



6400



36400



6425

Renewal Kit

Part No.	Description
6402	45 Tooth, 6400 Ratchet
36402	For 6425, 36400 Ratchet – Black

NOTE: When cleaning your ratchet re-lubricate with light oil only.



Sturdy
Single
Pawl

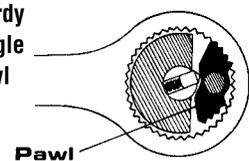

Pawl

Extensions

Part No.	Description
6403	3-1/2"
6408	8"
6416	16"

Meets or exceeds ASME B107.110



Flex Handles

Steel pin and tension washer construction for added strength. No binding or locked joint.

Part No.	Description	Overall Length
6435	Knurled Steel Handle	22"
36435	Black Knurled Steel Handle	21-5/8"

Meets or exceeds ASME B107.110



6435



36435

3/4"



Sockets, Ratchets & Attachments





Bull Bar

2-set screw locking position head – knurled grip 24" length. Extra strength for heavy-duty applications.

Part No.	Description
6440	24"
6441	Repair Kit for 6440

Meets or exceeds ASME B107.110



Universal

Steel pin and tension washer construction for added strength. No binding or locked joint.

Part No.	Overall Length
6475	3-13/16"

Meets or exceeds ASME B107.110



Sliding T

Head held in place by friction ball so it can slide to ends of bar with no overhang. Works in tighter places.

Part No.	Overall Length
6443	17-1/2"

Meets or exceeds ASME B107.110



Adaptor

For interchange of sockets and attachments from one drive size to another.

Part No.	Description	Length
6450	3/4" F x 1/2" M	2-1/8"

Meets or exceeds ASME B107.110

3/4"



Sockets, Ratchets & Attachments





Impact Universal Joint

Part No.	Description	Ret-Ring	Overall Length	OD
6800	Universal	6581	3-1/2"	1-7/8"

Meets or exceeds ASME B107.110



Impact Adaptors

Part No.	Description	Ret-Ring	Length
6900	3/4" F x 1/2" M	6580	2-1/8"
6901	3/4" F x 1" M	6581	2-1/2"

Guarantee does not apply
 Meets or exceeds ASME B107.110



6900



6901

3/4"



Sockets, Ratchets & Attachments





Impact Extensions

Part No.	Description	Ret-Ring
6907	7"	6581
6910	10"	6581
6913	13"	6581
69E24	24"	6581
69E36	36"	6581

Meets or exceeds ASME B107.110

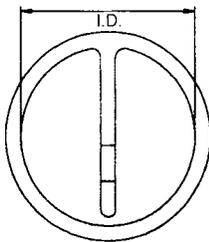

3/4" Drive Ret-Ring™ One-Piece Socket Retainers

Conveniently replaces "O" Rings and Pins. See individual part numbers for size.

Part No.	I.D.
6580	1-1/4"
6581	1-7/16"
6582	1-5/8"
6582A	1-3/4"
6582C	2"
6582B	2-1/8"
6582D	2-1/4"

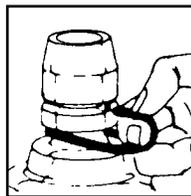

Step 1

Place Socket Retainer over square driver. Place Socket on square driver aligning retention holes. Hold center pin of Retainer between thumb and index finger, and insert it through retention holes.



Step 2

Push center pin of Socket Retainer all the way in.

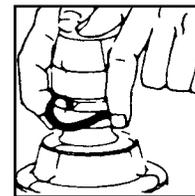

Step 3

Pull O-ring of Socket Retainer up into groove on Socket.



Sockets, Ratchets & Attachments





"O" Rings and Pins as an Alternative to Ret Rings

Ret Ring	Ret Ring ID	"O" Ring	"O" Ring Width	"O" Ring ID	Pin	Pin OD	Pin Length
6580	1-1/4"	6575	1/8"	1-1/4"	6576	3/16"	1-1/4"
6581	1-7/16"	6577	1/8"	1-7/16"	6576	3/16"	1-1/4"
6582	1-5/8"	6578	1/8"	1-5/8"	6576	3/16"	1-1/4"
6582A	1-3/4"	8677	1/8"	1-3/4"	8576	3/16"	1-3/4"
6582C	2"	8577	1/8"	1-3/4"	8576	3/16"	1-3/4"
6582B	2-1/8"	8578	1/8"	2-1/8"	8580	3/16"	2-1/8"
6582D	2-1/4"	8578	1/8"	2-1/8"	8580	3/16"	2-1/8"

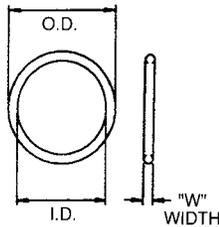

3/4"



Sockets, Ratchets & Attachments





⑥ Pt. Deep Sockets

Part No.	Nom. Size	Shape	L	Ds	Dd	Bd
6524	3/4"	II	3-1/2"	1-15/64"	1-19/64"	1/2"
6526	13/16"	II	3-1/2"	1-19/64"	—	1/2"
6528	7/8"	II	3-1/2"	1-3/8"	—	17/32"
6530	15/16"	II	3-1/2"	1-27/64"	—	9/16"
6532	1"	II	3-1/2"	1-15/32"	—	19/32"
6534	1-1/16"	III	3-1/2"	1-37/64"	1-7/16"	2-1/2"
6536	1-1/8"	III	3-1/2"	1-21/32"	1-7/16"	2-31/64"
6538	1-3/16"	III	3-1/2"	1-23/32"	1-32/64"	2-15/32"
6540	1-1/4"	III	3-1/2"	1-55/64"	1-1/2"	2-7/16"
6542	1-5/16"	III	3-1/2"	1-29/32"	1-9/16"	2-27/64"
6544	1-3/8"	III	3-1/2"	1-29/32"	1-9/16"	2-13/32"
6546	1-7/16"	III	3-1/2"	2-1/16"	1-43/64"	2-3/8"
6548	1-1/2"	III	3-1/2"	2-3/32"	1-43/64"	2-23/64"
6552	1-5/8"	III	3-1/2"	2-7/32"	1-39/64"	2-5/16"

Meets or exceeds ASME B107.110



⑫ Pt. Standard Sockets

Part No.	Nom. Size	Shape	L	Ds	Dd	Bd
6124	3/4"	I	2"	1-15/64"	1-19/64"	1/2"
6126	13/16"	II	2"	1-19/64"	—	1/2"
6128	7/8"	II	2"	1-3/8"	—	1/2"
6130	15/16"	II	2"	1-13/32"	—	35/64"
6132	1"	II	2-1/32"	1-15/32"	—	1-1/32"
6134	1-1/16"	III	2-1/16"	1-9/16"	1-29/64"	1-3/64"
6136	1-1/8"	III	2-1/8"	1-43/64"	1-29/64"	1-5/64"
6138	1-3/16"	III	2-1/8"	1-23/32"	1-29/64"	1-1/16"
6140	1-1/4"	III	2-3/16"	1-27/32"	1-37/64"	1-7/64"
6142	1-5/16"	III	2-1/4"	1-29/32"	1-37/64"	1-5/32"
6144	1-3/8"	III	2-1/4"	1-29/32"	1-37/64"	1-1/8"
6146	1-7/16"	III	2-5/16"	2-1/16"	1-37/64"	1-11/64"
6148	1-1/2"	III	2-5/16"	2-3/32"	1-39/64"	1-5/32"
6150	1-9/16"	III	2-7/16"	2-3/32"	1-39/64"	1-1/4"
6152	1-5/8"	III	2-1/2"	2-7/32"	1-39/64"	1-19/64"
6154	1-11/16"	III	2-1/2"	2-5/16"	1-5/8"	1-9/32"
6156	1-3/4"	III	2-21/32"	2-25/64"	1-43/64"	1-13/32"
6158	1-13/16"	III	2-13/16"	2-1/2"	1-3/4"	1-35/64"
6160	1-7/8"	III	2-7/8"	2-19/32"	1-3/4"	1-37/64"
6164	2"	III	3"	2-11/16"	1-3/4"	1-11/16"
6166	2-1/16"	III	3-1/32"	2-47/64"	1-61/64"	1-45/64"
6168	2-1/8"	III	3-1/16"	2-55/64"	1-61/64"	1-23/32"
6170	2-3/16"	III	3-1/16"	2-55/64"	1-61/64"	1-11/16"
6172	2-1/4"	III	3-1/16"	3-1/32"	1-61/64"	1-51/64"
6176	2-3/8"	III	3-1/32"	1-61/64"	1-13/16"	

Meets or exceeds ASME B107.110



Sockets, Ratchets & Attachments

Refer to socket dimensional drawings on page 206.





12 Pt. Standard Metric Sockets

Part No.	Nom. Size	Shape	L	Ds	Dd	Bd
61-19mm	19mm	I	50.80	31.34	32.94	12.70
61-21mm	21mm	II	50.80	32.94	—	12.70
61-22mm	22mm	II	50.80	34.14	—	12.70
61-23mm	23mm	II	50.80	34.52	—	13.49
61-24mm	24mm	II	50.80	34.93	—	13.89
61-25mm	25mm	II	51.21	36.53	—	14.30
61-26mm	26mm	II	51.21	37.31	—	26.08
61-27mm	27mm	III	52.39	40.08	36.91	26.59
61-28mm	28mm	III	53.98	40.87	36.91	28.41
61-29mm	29mm	III	53.98	42.06	36.91	28.08
61-30mm	30mm	III	53.98	42.88	36.91	27.75
61-31mm	31mm	III	55.58	44.45	40.08	29.02
61-32mm	32mm	III	55.58	46.43	40.08	28.68
61-35mm	35mm	III	57.15	48.41	40.08	28.58
61-36mm	36mm	III	58.74	51.59	40.08	30.52
61-38mm	38mm	III	60.33	53.19	41.28	31.43
61-41mm	41mm	III	64.29	56.36	40.87	34.39
61-42mm	42mm	III	65.10	56.36	40.87	34.87
61-46mm	46mm	III	73.03	60.33	44.45	41.47
61-50mm	50mm	III	76.20	66.27	44.45	43.31
61-54mm	54mm	III	77.80	72.24	49.23	43.66
61-55mm	55mm	III	80.16	72.62	49.23	45.60
61-58mm	58mm	III	82.55	75.41	49.23	46.99
61-60mm	60mm	III	82.55	79.38	49.23	46.32



Meets or exceeds ASME B107.110

Shape I

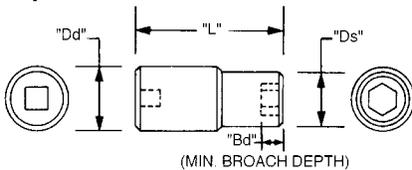

Shape II

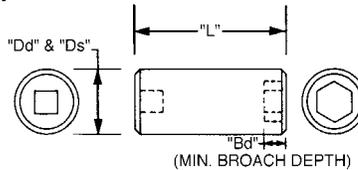

Shape III

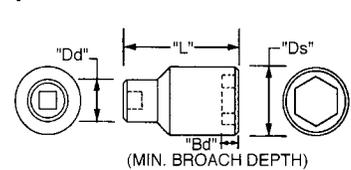



12 Pt. Impact Sockets

Black Industrial Finish



Part No.	Nom. Size	Ret-Ring	Shape	L	Ds	Dd	Bd
67H18	9/16"	6581	I	2-3/32"	1"	1-5/8"	21/64"
67H20	5/8"	6581	I	2-3/32"	1-3/32"	1-5/8"	9/32"
67H22	11/16"	6581	I	2-3/32"	1-11/64"	1-5/8"	5/16"
67H24	3/4"	6581	I	2-3/32"	1-15/64"	1-5/8"	9/16"
67H26	13/16"	6581	I	2-1/8"	1-3/8"	1-5/8"	39/64"
67H28	7/8"	6581	I	2-1/8"	1-1/2"	1-5/8"	39/64"
67H30	15/16"	6581	I	2-1/8"	1-9/16"	1-5/8"	19/32"
67H32	1"	6581	II	2-1/8"	1-5/8"		35/64"
67H34	1-1/16"	6581	II	2-1/8"	1-11/16"		1-7/64"
67H36	1-1/8"	6582	II	2-1/8"	1-3/4"		1-3/32"
67H38	1-3/16"	6582A	II	2-1/8"	1-7/8"		1-1/16"
67H40	1-1/4"	6582A	II	2-1/8"	2"		1-3/64"
67H42	1-5/16"	6582A	II	2-1/8"	2"		1-1/32"
67H44	1-3/8"	6582A	III	2-1/4"	2-1/8"	1-29/32"	1-1/8"
67H46	1-7/16"	6582A	III	2-1/4"	2-1/8"	1-29/32"	1-1/8"
67H48	1-1/2"	6582A	III	2-1/2"	2-5/16"	1-29/32"	1-23/64"
67H50	1-9/16"	6582A	III	2-1/2"	2-13/32"	1-29/32"	1-11/32"
67H52	1-5/8"	6582A	III	2-1/2"	2-7/16"	1-29/32"	1-5/16"
67H54	1-11/16"	6582A	III	2-5/8"	2-1/2"	1-29/32"	1-27/64"
67H56	1-3/4"	6582A	III	2-5/8"	2-1/2"	1-29/32"	1-13/32"
67H58	1-13/16"	6582A	III	2-5/8"	2-5/8"	1-29/32"	1-3/8"
67H60	1-7/8"	6582A	III	2-3/4"	2-23/32"	1-29/32"	1-31/64"
67H64	2"	6582A	III	2-7/8"	2-3/4"	1-29/32"	1-9/16"
67H66	2-1/16"	6582A	III	2-7/8"	2-7/8"	1-29/32"	1-35/64"
67H68	2-1/8"	6582A	III	3-1/16"	3"	1-29/32"	1-23/32"
67H70	2-3/16"	6582A	III	3-3/16"	3"	1-29/32"	1-13/16"
67H72	2-1/4"	6582A	III	3-3/16"	3-1/16"	1-29/32"	1-51/64"
67H76	2-3/8"	6582A	III	3-1/2"	3-1/4"	1-29/32"	2-1/16"

Meets or exceeds ASME B107.110

3/4"



Sockets, Ratchets & Attachments

Shape I

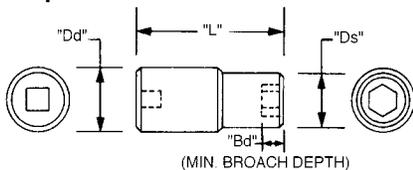

Shape II

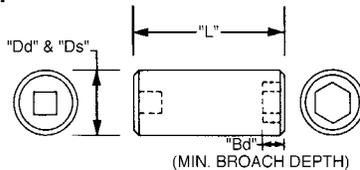

Shape III

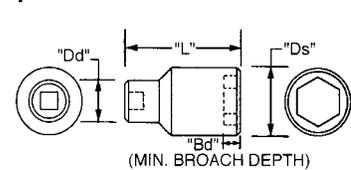



12 Pt. Metric Impact Sockets



Part No.	Nom. Size	Ret-Ring	Shape	L	Ds	Dd	Bd
67H-19mm	19mm	6581	I	48.41	31.75	41.28	14.30
67H-22mm	22mm	6581	I	50.80	34.93	41.28	14.30
67H-24mm	24mm	6581	I	50.80	39.70	41.28	14.30
67H-27mm	27mm	6581	II	53.98	42.88		17.48
67H-30mm	30mm	6581	III	53.98	47.63	42.06	27.75
67H-32mm	32mm	6582	III	53.98	50.80	45.64	27.08
67H-36mm	36mm	6582	III	57.15	53.98	45.64	28.92
67H-41mm	41mm	6582A	III	63.50	61.93	48.82	33.61
67H-46mm	46mm	6582A	III	66.68	66.68	48.82	35.12
67H-50mm	50mm	6582A	III	69.85	69.85	48.82	36.96
67H-55mm	55mm	6582A	III	77.85	79.63	48.82	47.00

Meets or exceeds ASME B107.110



3/4"



Sockets, Ratchets & Attachments

Refer to socket dimensional drawings on page 207.





6 Pt. Standard Impact Sockets



Part No.	Nom. Size	Ret-Ring	Shape	L	Ds	Dd	Bd
6818	9/16"	6581	I	2-3/32"	1"	1-5/8"	21/64"
6820	5/8"	6581	I	2-3/32"	1-7/64"	1-5/8"	9/32"
6822	11/16"	6581	I	2-3/32"	1-11/64"	1-5/8"	5/16"
6824	3/4"	6581	I	2-3/32"	1-1/4"	1-5/8"	9/16"
6826	13/16"	6581	I	2-1/8"	1-3/8"	1-5/8"	39/64"
6828	7/8"	6581	I	2-1/8"	1-1/2"	1-5/8"	39/64"
6830	15/16"	6581	I	2-1/8"	1-9/16"	1-5/8"	19/32"
6832	1"	6581	II	2-1/8"	1-5/8"	-	35/64"
6834	1-1/16"	6581	II	2-1/8"	1-11/16"	-	1-7/64"
6836	1-1/8"	6582	II	2-1/8"	1-3/4"	-	1-3/32"
6838	1-3/16"	6582A	II	2-1/8"	1-27/32"	-	1-1/16"
6840	1-1/4"	6582A	II	2-1/8"	1-59/64"	-	1-3/64"
6842	1-5/16"	6582A	II	2-1/8"	2"	-	1-1/32"
6844	1-3/8"	6582A	III	2-1/4"	2-1/16"	1-29/32"	1-1/8"
6846	1-7/16"	6582A	III	2-1/4"	2-5/32"	1-29/32"	1-1/8"
6848	1-1/2"	6582A	III	2-1/2"	2-15/64"	1-29/32"	1-23/64"
6850	1-9/16"	6582A	III	2-1/2"	2-5/16"	1-29/32"	1-11/32"
6852	1-5/8"	6582A	III	2-1/2"	2-13/32"	1-29/32"	1-5/16"
6854	1-11/16"	6582A	III	2-5/8"	2-31/64"	1-29/32"	1-27/64"
6856	1-3/4"	6582A	III	2-5/8"	2-9/16"	1-29/32"	1-13/32"
6858	1-13/16"	6582A	III	2-5/8"	2-41/64"	1-29/32"	1-3/8"
6860	1-7/8"	6582A	III	2-3/4"	2-23/32"	1-29/32"	1-31/64"
6862	1-15/16"	6582A	III	2-3/4"	2-13/16"	1-29/32"	1-15/32"
6864	2"	6582A	III	2-7/8"	2-57/64"	1-29/32"	1-9/16"
6890	2-1/16"	6582A	III	2-7/8"	2-31/32"	1-29/32"	1-35/64"
6892	2-1/8"	6582A	III	3-1/16"	3-3/64"	1-29/32"	1-23/32"
6894	2-3/16"	6582A	III	3-3/16"	3-9/64"	1-29/32"	1-13/16"
6896	2-1/4"	6582A	III	3-3/16"	3-7/32"	1-29/32"	1-51/64"
6898	2-3/8"	6582A	III	3-1/4"	3-3/8"	1-29/32"	2-1/16"
68100	2-7/16"	6582C	III	3-1/4"	3-29/64"	2-1/4"	1-15/16"
68102	2-1/2"	6582C	III	3-1/4"	3-17/32"	2-1/4"	1-15/16"
68104	2-9/16"	6582C	III	3-1/4"	3-19/32"	2-1/4"	1-7/8"
68106	2-5/8"	6582C	III	3-1/4"	3-43/64"	2-1/4"	1-7/8"
68108	2-11/16"	6582C	III	3-1/2"	3-3/4"	2-1/4"	1-7/8"
68110	2-3/4"	6582C	III	3-1/2"	3-13/16"	2-1/4"	2"
68112	2-13/16"	6582C	III	3-1/2"	3-57/64"	2-1/4"	2"
68114	2-7/8"	6582C	III	3-1/2"	3-31/32"	2-1/4"	2"
68116	2-15/16"	6582C	III	3-3/4"	4-1/32"	2-1/4"	2-1/4"
68118	3"	6582C	III	3-3/4"	4-7/64"	2-1/4"	2-1/4"

Meets or exceeds ASME B107.110



Sockets, Ratchets & Attachments

Refer to socket dimensional drawings on page 210.





⑥ Pt. Standard Metric Impact Sockets



Part No.	Nom. Size	Ret-Ring	Shape	L	Ds	Dd	Bd
68-17mm	17mm	6581	I	48.41	29.77	41.28	9.53
68-19mm	19mm	6581	I	48.41	31.75	41.28	14.30
68-20mm	20mm	6581	I	48.41	34.13	41.28	15.47
68-21mm	21mm	6581	I	50.80	34.93	41.28	15.47
68-22mm	22mm	6581	I	50.80	34.93	41.28	14.30
68-23mm	23mm	6581	I	50.80	39.70	41.28	12.70
68-24mm	24mm	6581	I	50.80	39.70	41.28	14.30
68-26mm	26mm	6581	II	50.80	41.28	—	17.48
68-27mm	27mm	6581	II	53.98	42.88	—	17.48
68-28mm	28mm	6581	II	53.98	44.45	—	27.83
68-29mm	29mm	6581	III	53.98	46.05	41.68	28.08
68-30mm	30mm	6581	III	53.98	47.63	42.06	27.75
68-32mm	32mm	6582	III	53.98	50.80	45.64	27.08
68-33mm	33mm	6582	III	53.98	50.80	45.64	26.75
68-34mm	34mm	6582	III	53.98	50.80	45.64	26.41
68-35mm	35mm	6582	III	57.15	53.98	45.64	29.26
68-36mm	36mm	6582	III	57.15	53.98	45.64	28.92
68-38mm	38mm	6582	III	57.15	58.75	45.64	28.26
68-41mm	41mm	6582A	III	63.50	61.93	48.82	33.61
68-42mm	42mm	6582A	III	65.10	62.71	48.82	34.87
68-43mm	43mm	6582A	III	66.68	63.50	48.82	36.12
68-46mm	46mm	6582A	III	66.68	66.68	48.82	35.12
68-50mm	50mm	6582A	III	69.85	69.85	48.82	36.96



Meets or exceeds ASME B107.110

Shape I

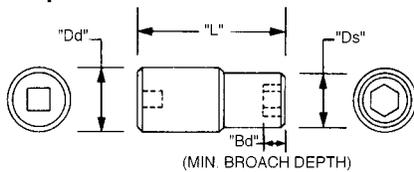

Shape II

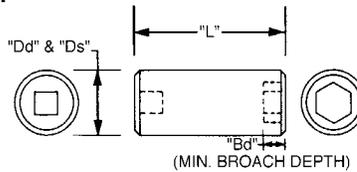

Shape III

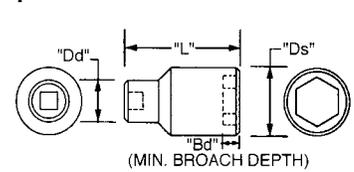



6 Pt. Deep Impact Sockets



Part No.	Nom. Size	Ret-Ring	Shape	L	Ds	Dd	Bd
6918	9/16"	6581	I	3-7/64"	1"	1-5/8"	21/64"
6920	5/8"	6581	I	3-7/64"	1-7/64"	1-5/8"	3/8"
6922	11/16"	6581	I	3-7/64"	1-11/64"	1-5/8"	3/8"
6924	3/4"	6581	I	3-7/64"	1-1/4"	1-5/8"	9/16"
6926	13/16"	6581	I	3-7/64"	1-3/8"	1-5/8"	39/64"
6928	7/8"	6581	I	3-7/64"	1-1/2"	1-5/8"	39/64"
6930	15/16"	6581	I	3-7/64"	1-9/16"	1-5/8"	19/32"
6932	1"	6581	II	3-7/64"	1-5/8"	-	35/64"
6934	1-1/16"	6581	II	3-1/2"	1-11/16"	-	2-31/64"
6936	1-1/8"	6582	II	3-1/2"	1-3/4"	-	2-15/32"
6938	1-3/16"	6582A	II	3-1/2"	1-27/32"	-	2-7/16"
6940	1-1/4"	6582A	II	3-1/2"	1-59/64"	-	2-27/64"
6942	1-5/16"	6582A	II	3-1/2"	2"	-	2-1/2"
6944	1-3/8"	6582A	III	3-1/2"	2-1/16"	1-29/32"	2-13/32"
6946	1-7/16"	6582A	III	3-1/2"	2-5/32"	1-29/32"	2-3/8"
6948	1-1/2"	6582A	III	3-1/2"	2-15/64"	1-29/32"	2-23/64"
6950	1-9/16"	6582A	III	3-1/2"	2-5/16"	1-29/32"	2-11/32"
6952	1-5/8"	6582A	III	3-1/2"	2-13/32"	1-29/32"	2-5/16"
6954	1-11/16"	6582A	III	3-1/2"	2-31/64"	1-29/32"	2-19/64"
6956	1-3/4"	6582A	III	3-1/2"	2-9/16"	1-29/32"	2-9/32"
6958	1-13/16"	6582A	III	3-1/2"	2-41/64"	1-29/32"	2-1/4"
6960	1-7/8"	6582A	III	3-1/2"	2-23/32"	1-29/32"	2-15/64"
6962	1-15/16"	6582A	III	3-1/2"	2-13/16"	1-29/32"	2-7/32"
6964	2"	6582A	III	3-3/4"	2-57/64"	1-29/32"	2-25/64"
6966	2-1/16"	6582A	III	3-3/4"	2-31/32"	1-29/32"	2-7/16"
6968	2-1/8"	6582A	III	3-3/4"	3-3/64"	1-29/32"	2-7/16"
69100	2-3/16"	6582A	III	4-1/4"	3-9/64"	1-29/32"	2-1/2"
69102	2-1/4"	6582A	III	4-1/4"	3-9/64"	1-29/32"	2-1/2"
69104	2-5/16"	6582A	III	4-1/4"	3-19/64"	1-29/32"	2-1/2"
69106	2-3/8"	6582A	III	4-1/4"	3-3/8"	1-29/32"	2-1/2"
69108	2-7/16"	6582C	III	4-1/4"	3-29/64"	2-1/4"	2-1/2"
69110	2-1/2"	6582C	III	4-1/4"	3-17/32"	2-1/4"	2-7/8"
69112	2-9/16"	6582C	III	4-1/4"	3-19/32"	2-1/4"	2-7/8"
69114	2-5/8"	6582C	III	4-1/4"	3-43/64"	2-1/4"	2-7/8"
69116	2-11/16"	6582C	III	4-1/2"	3-3/4"	2-1/4"	3"
69118	2-3/4"	6582C	III	4-1/2"	3-13/16"	2-1/4"	3"
69120	2-13/16"	6582C	III	4-1/2"	3-57/64"	2-1/4"	3"
69122	2-7/8"	6582C	III	4-1/2"	3-31/32"	2-1/4"	3"
69124	2-15/16"	6582C	III	4-3/4"	4-1/32"	2-1/4"	3-1/4"
69126	3"	6582C	III	4-3/4"	4-7/64"	2-1/4"	3-1/4"

Meets or exceeds ASME B107.110

Shape I

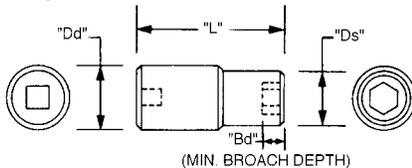

Shape II

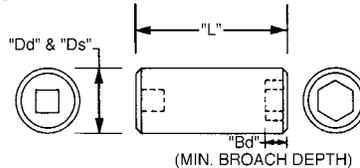

Shape III

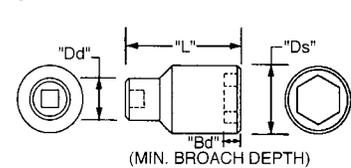



12 Pt. Deep Impact Sockets



Part No.	Nom. Size	Ret-Ring	Shape	L	Ds	Dd	Bd
6969	9/16"	6581	I	3-1/4"	1"	1-5/8"	21/64"
6970	5/8"	6581	I	3-1/4"	1-3/32"	1-5/8"	3/8"
6972	11/16"	6581	I	3-1/4"	1-5/32"	1-5/8"	3/8"
6974	3/4"	6581	I	3-1/4"	1-1/4"	1-5/8"	7/16"
6976	13/16"	6581	I	3-1/4"	1-3/8"	1-5/8"	29/64"
6978	7/8"	6581	I	3-1/4"	1-1/2"	1-5/8"	1/2"
6980	15/16"	6581	I	3-1/4"	1-9/16"	1-5/8"	35/64"
6982	1"	6581	II	3-1/4"	1-5/8"	1-5/8"	35/64"

Meets or exceeds ASME B107.110



6 Pt. Deep Metric Impact Sockets



Part No.	Nom. Size	Ret-Ring	Shape	L	Ds	Dd	Bd
69-19mm	19mm	6581	I	78.97	31.75	41.28	11.13
69-21mm	21mm	6581	I	78.97	34.93	41.28	11.51
69-22mm	22mm	6581	I	78.97	34.93	41.28	12.70
69-23mm	23mm	6581	I	78.97	38.89	41.28	12.70
69-24mm	24mm	6581	I	78.97	39.70	41.28	14.30
69-26mm	26mm	6582	I	88.90	41.28	44.45	63.42
69-27mm	27mm	6582	I	88.90	42.88	44.45	63.10
69-30mm	30mm	6582A	I	88.90	47.63	-	62.09
69-32mm	32mm	6582A	II	88.90	50.80	-	61.42
69-33mm	33mm	6582A	II	88.90	50.80	-	61.09
69-35mm	35mm	6582A	III	88.90	53.98	48.26	61.12
69-36mm	36mm	6582A	III	88.90	53.98	48.26	60.67
69-38mm	38mm	6582A	III	88.90	58.75	48.26	60.01
69-41mm	41mm	6582A	III	88.90	61.93	48.26	59.01
69-43mm	43mm	6582A	III	88.90	63.50	48.26	58.34
69-46mm	46mm	6582A	III	88.90	69.00	48.26	57.00
69-50mm	50mm	6582A	III	95.25	73.40	48.26	63.50

Meets or exceeds ASME B107.110



3/4"



Sockets, Ratchets & Attachments

Refer to socket dimensional drawings on page 213.





8 Pt. Double Square Impact (Railroad) Sockets



Part No.	Nom. Size	Ret-Ring	Shape	L	Ds	Dd	Bd
6865	3/4"	6581	II	2-1/8"	1-5/8"	-	1/2"
6866	13/16"	6581	II	2-1/8"	1-11/16"	-	1/2"
6868	7/8"	6582	II	2-1/8"	1-3/4"	-	1-7/64"
6870	15/16"	6582	II	2-1/8"	1-13/16"	-	1-5/64"
6872	1"	6582A	II	2-1/8"	2"	-	1-3/64"
6874	1-1/16"	6582A	III	2-1/4"	2-1/8"	1-29/32"	1-5/32"
6876	1-1/8"	6582A	III	2-1/4"	2-1/4"	1-29/32"	1-1/8"
6878	1-3/16"	6582A	III	2-1/2"	2-5/16"	1-29/32"	1-11/32"
6880	1-1/4"	6582A	III	2-1/2"	2-7/16"	1-29/32"	1-21/32"
6882	1-5/16"	6582A	III	2-5/8"	2-1/2"	1-29/32"	1-27/64"
6886	1-7/16"	6582A	III	2-3/4"	2-11/32"	1-29/32"	1-1/2"

Meets or exceeds ASME B107.110

3/4"



Sockets, Ratchets & Attachments

Shape I

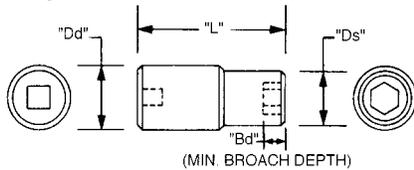

Shape II

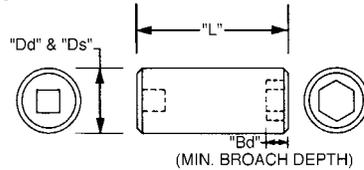

Shape III

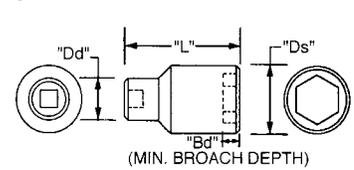



Budd Wheel Impact Sockets

Part No.	Nom. Size	Ret-Ring	Shape	L	Ds	Dd	Bd
6893	13/16" Sq. Std. Length Budd Wheels	6581	II	2-1/4"	1-5/8"	-	5/8"
6991	1-1/2" Hex x 13/16" Sq. Long Length Combination Socket Budd Wheels	6582B	II	3-13/16"	2-1/4"	-	3/4"
6993	13/16" Sq. Long Length Budd Wheels	6582	II	3-1/8"	1-25/32"	-	5/8"

Meets or exceeds ASME B107.110



6991

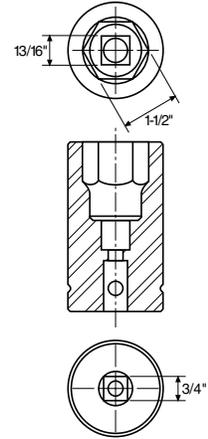

6893



6993

3/4"



Sockets, Ratchets & Attachments

Refer to socket dimensional drawings on page 213.





Square Budd Wheel Metric Impact Sockets

Part No.	Nom. Size	Ret-Ring	Shape	L	Ds	Dd	Bd
68-87mm	17mm Sq.	6581	II	55.56	41.28	-	15.66
	Std. Length						
68-91mm	21mm Sq.	6581	II	55.56	41.28	-	15.66
	Std. Length						

Meets or exceeds ASME B107.110



Hex Bit Sockets

Part No.	Nom. Size	Ret-Ring	Shape	L	L1	Ds	Dd	Bd
6218	9/16"	6581	IV	3-9/32"	1-3/16"	1"	1-5/8"	1-3/16"
6220	5/8"	6581	IV	3-1/4"	1-3/16"	1-3/32"	1-5/8"	1-5/32"
6224	3/4"	6581	IV	3-11/32"	1-5/16"	1-15/64"	1-5/8"	1-1/4"
6228	7/8"	6581	IV	3-1/2"	1-7/16"	1-1/2"	1-5/8"	1-3/8"
6232	1"	6581	IV	3-5/8"	1-9/16"	1-5/8"	-	1-1/2"

Meets or exceeds ASME B107.110



Replacement Hex Bits

Part No.	Nom. Size	Use For Socket No.	L
6218B	9/16"	6218	1-13/16"
6220B	5/8"	6220	1-13/16"
6224B	3/4"	6224	1-13/16"
6228B	7/8"	6228	1-15/16"
6232B	1"	6232	2-1/16"

Meets or exceeds ASME B107.110



Metric Hex Bit Sockets

Part No.	Nom. Size	Ret-Ring	Shape	L	L1	Ds	Dd	Bd
62-14mm	14mm	6581	IV	83.34	35.00	25.40	41.28	34.93
62-17mm	17mm	6581	IV	83.34	35.00	30.16	41.28	34.93
62-19mm	19mm	6581	IV	83.34	35.00	31.75	41.28	34.93
62-22mm	22mm	6581	IV	95.25	35.00	34.93	41.28	34.93
62-24mm	24mm	6581	IV	95.25	35.00	39.69	41.28	34.93

Meets or exceeds ASME B107.110

Refer to socket dimensional drawings on page 216.



WARNING
Wear safety goggles user and bystander.



WARNING
Before using tools, read safety information on pages 399-403.



WARNING
Comfort or plastic grips do not protect against electric shock.





Metric Replacement Hex Bits

Part No.	Nom. Size	Use For Socket No.	L
62M14B	14mm	62-14mm	83.34
62M17B	17mm	62-17mm	83.34
62M19B	19mm	62-19mm	83.34
62M22B	22mm	62-22mm	95.25
62M24B	24mm	62-24mm	95.25

Meets or exceeds ASME B107.110



Ball Joint Impact Sockets

Part No.	Nom. Size	Shape	L	Ds	Dd	Bd
6888	1-7/8"	III	2-3/32"	2-7/16"	1-21/32"	3/8"
6889	2-1/8"	III	2-3/32"	2-23/32"	1-15/16"	7/16"

Sockets for Plymouth, Dodge & Chrysler products.
 Meets or exceeds ASME B107.110



6888



6889

Shape I

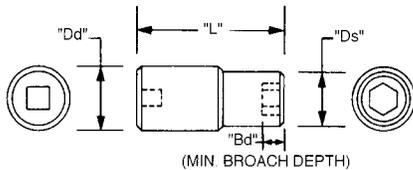

Shape II

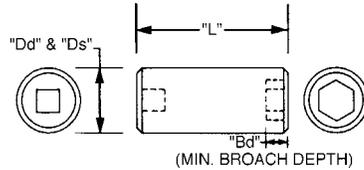

Shape III

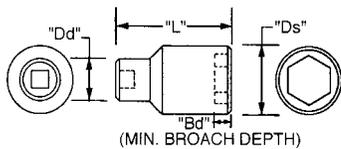

Shape IV

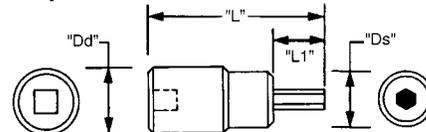

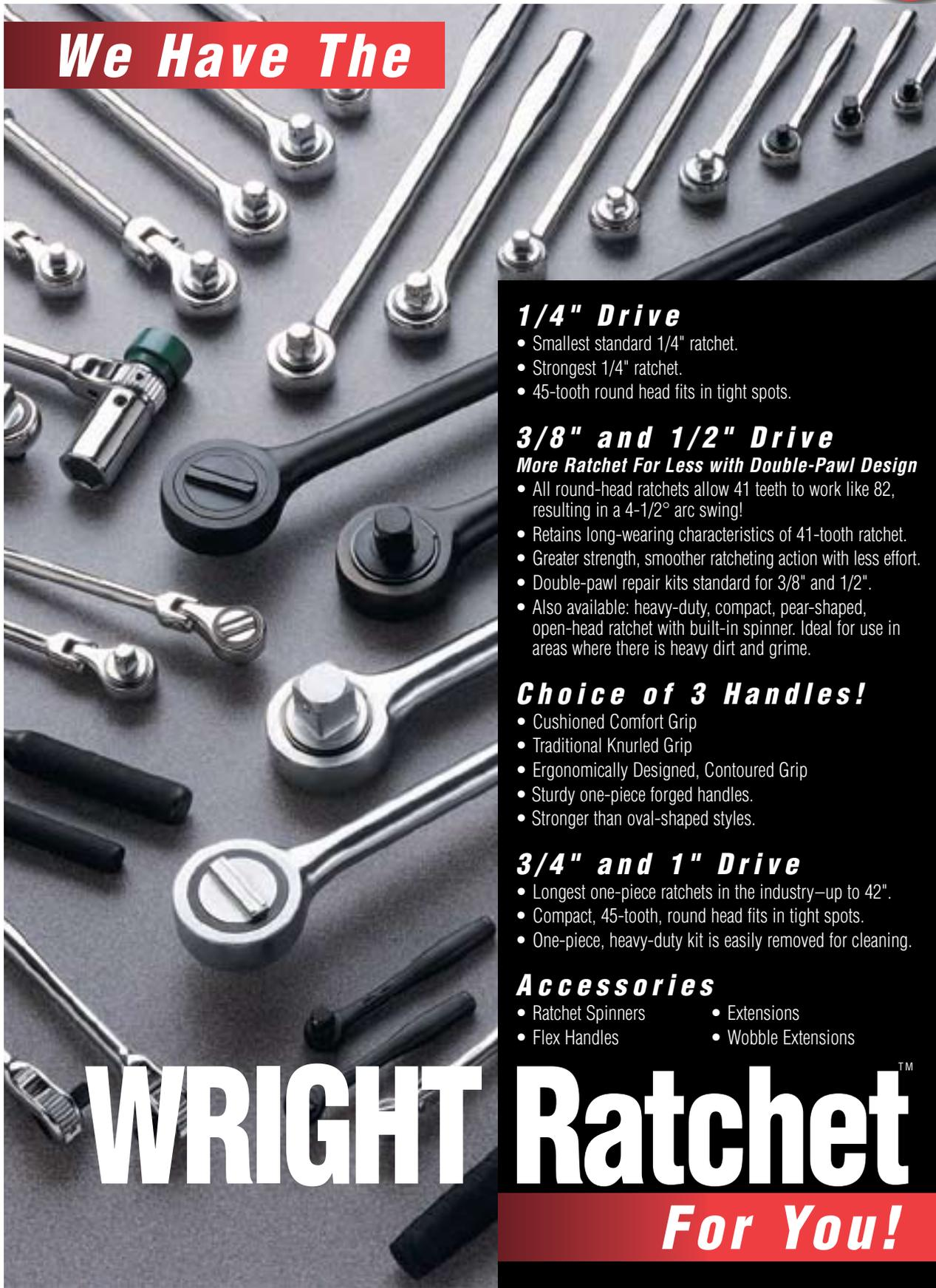

We Have The

1/4" Drive

- Smallest standard 1/4" ratchet.
- Strongest 1/4" ratchet.
- 45-tooth round head fits in tight spots.

3/8" and 1/2" Drive

More Ratchet For Less with Double-Pawl Design

- All round-head ratchets allow 41 teeth to work like 82, resulting in a 4-1/2° arc swing!
- Retains long-wearing characteristics of 41-tooth ratchet.
- Greater strength, smoother ratcheting action with less effort.
- Double-pawl repair kits standard for 3/8" and 1/2".
- Also available: heavy-duty, compact, pear-shaped, open-head ratchet with built-in spinner. Ideal for use in areas where there is heavy dirt and grime.

Choice of 3 Handles!

- Cushioned Comfort Grip
- Traditional Knurled Grip
- Ergonomically Designed, Contoured Grip
- Sturdy one-piece forged handles.
- Stronger than oval-shaped styles.

3/4" and 1" Drive

- Longest one-piece ratchets in the industry—up to 42".
- Compact, 45-tooth, round head fits in tight spots.
- One-piece, heavy-duty kit is easily removed for cleaning.

Accessories

- Ratchet Spinners
- Flex Handles
- Extensions
- Wobble Extensions

WRIGHT Ratchet™

For You!



3/4"

Sockets, Ratchets & Attachments





**29 Pieces – 12 Pt. Standard Socket Set
 Set No. 829**

Part No.	Description	Part No.	Description
8146	1-7/16"	8180	2-1/2"
8148	1-1/2"	8182	2-9/16"
8152	1-5/8"	8184	2-5/8"
8154	1-11/16"	8188	2-3/4"
8156	1-3/4"	8190	2-13/16"
8158	1-13/16"	8194	2-15/16"
8160	1-7/8"	8196	3
8162	1-15/16"	8197	3-1/8"
8164	2"	8400	Ratchet
8168	2-1/8"	8408	8" Extension
8170	2-3/16"	8417	17" Extension
8172	2-1/4"	8435	Flex Handle
8174	2-5/16"	8440	Bull Bar
8176	2-3/8"	8443	Sliding T
8178	2-7/16"	299	Metal Box



**21 Pieces – 12 Pt. Standard Socket Set
 Set No. 821**

Part No.	Description	Part No.	Description
8146	1-7/16"	8176	2-3/8"
8148	1-1/2"	8180	2-1/2"
8152	1-5/8"	8184	2-5/8"
8154	1-11/16"	8188	2-3/4"
8156	1-3/4"	8194	2-15/16"
8158	1-13/16"	8197	3-1/8"
8160	1-7/8"	8400	Ratchet
8164	2"	8408	8" Extension
8168	2-1/8"	8417	17" Extension
8170	2-3/16"	8443	Sliding T
8172	2-1/4"	299	Metal Box



1" Sockets, Ratchets & Attachments





8400



38400



8425

Ratchets

Drop forged, one-piece handle. Handle design allows operator to "feel" the fastener. Precision-machined 45 tooth head gives long life and short arc swing. Kit is easily removed for cleaning or replacement.

Part No.	Description	Overall Length
----------	-------------	----------------

8400	Knurled Steel Handle	30"
38400	Black Knurled Steel Handle	30"
8425	Long Black Knurled Steel Handle	42"

Meets or exceeds ASME B107.110

Sturdy
Single
Pawl

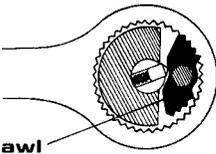

Renewal Kit

Part No.	Description
----------	-------------

8402	45 Tooth, 8400 Ratchet
38402	For 8425, 38400 Ratchet – Black

NOTE: When cleaning your ratchet re-lubricate with light oil only.
Meets or exceeds ASME B107.110



Extensions

Part No.	Description
----------	-------------

8408	8"
8417	17"

Meets or exceeds ASME B107.110





Flex Handles

Steel pin and tension washer construction for added strength. No binding or locked joint.

Part No.	Description
----------	-------------

8435	26"
------	-----

Meets or exceeds ASME B107.110



Bull Bar

2-position drive square. Used at end or center of handle. Secured with socket head screw.

Part No.	Description
----------	-------------

8440	30" Bull Bar, Stopping Points 1-5/16" and 13-11/16"
8441	Repair Kit for 8440

Meets or exceeds ASME B107.110



Sliding T

Head held in place by friction ball so it can slide to ends of bar with no overhang. Works in tighter places.

Part No.	Overall Length
----------	----------------

8443	22"
------	-----

Meets or exceeds ASME B107.110



1"



Sockets, Ratchets & Attachments





Impact Universal Joint

Part No.	Description	Ret-Ring	Overall Length	OD
8800	Universal	6581A	4-1/2"	2-1/2"

Meets or exceeds ASME B107.110



Impact Adaptors

Part No.	Description	Ret-Ring	Length
8900	1" F x 3/4" M	6583	2-3/4"
8902	1" F x 1-1/2" M	6584	3-1/2"

Guarantee does not apply

Meets or exceeds ASME B107.110



Impact Extensions

Part No.	Description	Ret-Ring
8907	7"	6581A
8910	10"	6581A
8913	13"	6581A
89E24	24"	6581A

Meets or exceeds ASME B107.110

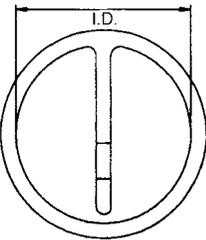

1" Drive Ret-Ring™ One-Piece Socket Retainers

Conveniently replaces "O" Rings and Pins. See individual part numbers for size.

Part No.	I.D.
6583	1-3/4"
6581A	2"
6584	2-1/8"
6585	2-1/4"
6586	2-1/2"
6587	3-1/8"

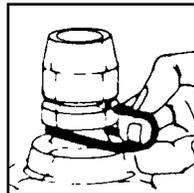

Step 1
Place Socket Retainer over square driver. Place Socket on square driver aligning retention holes. Hold center pin of Retainer between thumb and index finger, and insert it through retention holes.



Step 2
Push center pin of Socket Retainer all the way in.

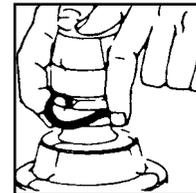

Step 3
Pull O-ring of Socket Retainer up into groove on Socket.





"O" Rings and Pins as an Alternative to Ret Rings

Ret Ring	Ret Ring ID	"O" Ring	"O" Ring Width	"O" Ring ID	Pin	Pin OD	Pin Length
6583	1-3/4"	8577	1/8"	1-3/4"	8576	3/16"	1-3/4"
6581A	2"	8577	1/8"	1-3/4"	8576	3/16"	1-3/4"
6584	2-1/8"	8578	1/8"	2-1/8"	8580	3/16"	2-1/8"
6585	2-1/4"	8578	1/8"	2-1/8"	8580	3/16"	2-1/8"
6586	2-1/2"	8578	1/8"	2-1/8"	8580	3/16"	2-1/8"
6587	3-1/8"	No "O" ring available			No pin available		

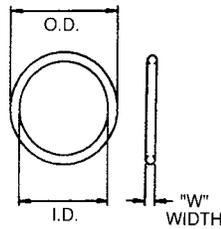

1"



Sockets, Ratchets & Attachments





12 Pt. Standard Sockets

Part No.	Nom. Size	Shape	L	Ds	Dd	Bd
8134	1-1/16"	II	2-9/32"	1-41/64"	1-41/64"	5/8"
8136	1-1/8"	II	2-9/32"	1-11/16"	1-11/16"	21/32"
8138	1-3/16"	II	2-9/32"	1-3/4"	1-3/4"	21/32"
8140	1-1/4"	II	2-9/32"	1-13/16"	1-13/16"	3/4"
8142	1-5/16"	II	2-11/32"	1-7/8"	1-7/8"	49/64"
8144	1-3/8"	III	2-7/16"	1-15/16"	1-3/4"	25/32"
8146	1-7/16"	III	2-1/2"	2"	1-3/4"	7/8"
8148	1-1/2"	III	2-9/16"	2-1/8"	1-3/4"	55/64"
8152	1-5/8"	III	2-11/16"	2-1/4"	1-3/4"	1"
8154	1-11/16"	III	2-3/4"	2-3/8"	1-15/16"	1"
8156	1-3/4"	III	2-13/16"	2-1/2"	1-15/16"	1-3/32"
8158	1-13/16"	III	2-7/8"	2-9/16"	1-15/16"	1-1/8"
8160	1-7/8"	III	2-15/16"	2-5/8"	2-1/4"	1-1/8"
8162	1-15/16"	III	3"	2-3/4"	2-1/4"	1-7/32"
8164	2"	III	3"	2-3/4"	2-1/4"	1-7/32"
8166	2-1/16"	III	3-1/16"	2-15/16"	2-1/4"	1-7/32"
8168	2-1/8"	III	3-1/16"	2-15/16"	2-1/4"	1-3/8"
8170	2-3/16"	III	3-9/32"	3"	2-1/4"	1-3/8"
8172	2-1/4"	III	3-9/32"	3-1/16"	2-1/4"	1-3/8"
8174	2-5/16"	III	3-9/32"	3-5/32"	2-1/4"	1-3/8"
8176	2-3/8"	III	3-5/16"	3-1/4"	2-1/4"	1-3/8"
8178	2-7/16"	III	3-3/8"	3-5/16"	2-1/4"	1-3/8"
8180	2-1/2"	III	3-7/16"	3-3/8"	2-1/4"	1-3/8"
8182	2-9/16"	III	3-1/2"	3-3/8"	2-1/4"	1-1/2"
8184	2-5/8"	III	3-9/16"	3-9/16"	2-1/4"	1-3/4"
8188	2-3/4"	III	3-13/16"	3-23/32"	2-43/64"	1-3/4"
8190	2-13/16"	III	3-13/16"	3-53/64"	2-43/64"	1-3/4"
8194	2-15/16"	III	3-7/8"	3-61/64"	2-43/64"	2"
8196	3"	III	4-3/16"	4-1/64"	2-43/64"	2"
8197	3-1/8"	III	4-3/16"	4-11/64"	2-43/64"	2-13/64"
8198	3-3/8"	III	4-1/2"	4-17/32"	2-43/64"	2-13/64"
8199	3-1/2"	III	4-1/2"	4-11/16"	2-43/64"	2-13/64"

Meets or exceeds ASME B107.110



12 Pt. Standard Impact Sockets

Part No.	Nom. Size	Ret-Ring Shape	L	Ds	Dd	Bd	
8724	3/4"	6583	I	2-1/4"	1-7/16"	2"	7/16"
8728	7/8"	6583	I	2-13/32"	1-17/32"	2"	1/2"
8730	15/16"	6583	I	2-7/16"	1-9/16"	2"	1/2"
8732	1"	6583	I	2-17/32"	1-3/4"	2"	35/64"
8734	1-1/16"	6583	I	2-9/16"	1-3/4"	2"	5/8"
8736	1-1/8"	6583	I	2-9/16"	1-13/16"	2"	21/32"
8740	1-1/4"	6583	II	2-11/16"	2-1/16"	-	3/4"
8742	1-5/16"	6583	II	2-11/16"	2-1/16"	-	49/64"
8744	1-3/8"	6581A	III	2-11/16"	2-1/4"	2-3/32"	25/32"
8746	1-7/16"	6581A	III	2-11/16"	2-1/4"	2-3/32"	7/8"
8748	1-1/2"	6581A	III	2-11/16"	2-1/4"	2-3/32"	55/64"
8752	1-5/8"	6581A	III	2-11/16"	2-1/2"	2-3/32"	1"
8754	1-11/16"	6581A	III	2-11/16"	2-1/2"	2-3/32"	1"
8756	1-3/4"	6584	III	2-11/16"	2-3/4"	2-3/8"	1-3/32"
8760	1-7/8"	6584	III	2-13/16"	2-3/4"	2-3/8"	1-1/8"
8764	2"	6584	III	3"	2-63/64"	2-3/8"	1-7/32"
8766	2-1/16"	6584	III	3"	2-63/64"	2-3/8"	1-7/32"
8772	2-1/4"	6584	III	3-3/16"	3-1/4"	2-3/8"	1-3/8"
8776	2-3/8"	6584	III	3-1/4"	3-1/2"	2-3/8"	1-3/8"

Meets or exceeds ASME B107.110

Refer to socket dimensional drawings on page 225.





⑥ Pt. Standard Impact Sockets



Part No.	Nom. Size	Ret-Ring Shape	L	Ds	Dd	Bd	
8824	3/4"	6583	I	2-1/4"	1-7/16"	2"	7/16"
8826	13/16"	6583	I	2-1/4"	1-7/16"	2"	29/64"
8828	7/8"	6583	I	2-13/32"	1-17/32"	2"	1/2"
8830	15/16"	6583	I	2-7/16"	1-9/16"	2"	1/2"
8832	1"	6583	I	2-17/32"	1-21/32"	2"	35/64"
8834	1-1/16"	6583	I	2-9/16"	1-3/4"	2"	5/8"
8836	1-1/8"	6583	I	2-9/16"	1-13/16"	2"	21/32"
8838	1-3/16"	6583	I	2-11/16"	1-31/32"	2-1/16"	21/32"
8840	1-1/4"	6583	II	2-11/16"	2-1/16"	-	3/4"
8842	1-5/16"	6583	II	2-11/16"	2-1/16"	-	49/64"
8844	1-3/8"	6581A	III	2-11/16"	2-1/4"	2-1/8"	25/32"
8846	1-7/16"	6581A	III	2-11/16"	2-1/4"	2-1/8"	7/8"
8848	1-1/2"	6581A	III	2-11/16"	2-1/4"	2-1/8"	55/64"
8850	1-9/16"	6584	III	2-11/16"	2-1/2"	2-1/4"	55/64"
8852	1-5/8"	6584	III	2-11/16"	2-1/2"	2-1/4"	1"
8854	1-11/16"	6584	III	2-11/16"	2-1/2"	2-1/4"	1"
8856	1-3/4"	6585	III	2-11/16"	2-3/4"	2-7/16"	1-3/32"
8858	1-13/16"	6585	III	2-11/16"	2-3/4"	2-7/16"	1-1/8"
8860	1-7/8"	6585	III	2-13/16"	2-3/4"	2-7/16"	1-1/8"
8862	1-15/16"	6585	III	3"	2-63/64"	2-7/16"	1-1/8"
8864	2"	6585	III	3"	2-63/64"	2-7/16"	1-7/32"
8866	2-1/16"	6585	III	3"	2-63/64"	2-7/16"	1-7/32"
8868	2-1/8"	6585	III	3"	3-5/32"	2-7/16"	1-7/32"
8870	2-3/16"	6585	III	3-3/16"	3-1/4"	2-7/16"	1-3/8"
8872	2-1/4"	6585	III	3-3/16"	3-1/4"	2-7/16"	1-3/8"
8874	2-5/16"	6585	III	3-3/16"	3-13/32"	2-7/16"	1-3/8"
8876	2-3/8"	6585	III	3-1/4"	3-1/2"	2-7/16"	1-3/8"
8878	2-7/16"	6585	III	3-9/32"	3-1/2"	2-7/16"	1-3/8"
8880	2-1/2"	6585	III	3-5/16"	3-1/2"	2-7/16"	1-3/8"
8882	2-9/16"	6586	III	3-5/16"	3-23/32"	2-3/4"	1-3/8"
8884	2-5/8"	6586	III	3-15/32"	3-23/32"	2-3/4"	1-1/2"
8886	2-11/16"	6586	III	3-15/32"	3-53/64"	2-3/4"	1-1/2"
8888	2-3/4"	6586	III	3-9/16"	3-53/64"	2-3/4"	1-3/4"
8890	2-13/16"	6586	III	3-11/16"	4"	2-3/4"	1-3/4"
8892	2-7/8"	6586	III	3-3/4"	4"	2-3/4"	1-3/4"
8894	2-15/16"	6586	III	3-3/4"	4"	2-3/4"	1-3/4"
8896	3"	6586	III	3-7/8"	4-3/16"	2-3/4"	2"
8897	3-1/8"	6586	III	3-15/16"	4-3/16"	2-3/4"	1-15/16"
8897A	3-1/4"	6586	III	4-1/16"	4-17/32"	2-3/4"	2"
8898	3-3/8"	6586	III	4-3/16"	4-17/32"	2-3/4"	2"
8899	3-1/2"	6586	III	4-5/16"	4-3/4"	2-3/4"	2-13/64"
88116	3-5/8"	6587	III	4-3/4"	4-55/64"	3-1/4"	2-1/2"
88120	3-3/4"	6587	III	5"	5"	3-1/4"	2-1/2"
88124	3-7/8"	6587	III	5-1/4"	5-7/64"	3-1/4"	2-1/2"
88128	4"	6587	III	5-3/8"	5-1/4"	3-1/4"	2-1/2"
88132	4-1/8"	6587	III	5-3/8"	5-3/8"	3-1/4"	2-19/32"
88136	4-1/4"	6587	III	5-1/2"	5-17/32"	3-1/4"	2-3/4"
88144	4-1/2"	6587	III	5-5/8"	5-13/16"	3-1/4"	2-27/32"

Meets or exceeds ASME B107.110



1"



Sockets, Ratchets & Attachments





⑥ Pt. Standard Metric Impact Sockets



Part No.	Nom. Size	Ret-Ring	Shape	L	Ds	Dd	Bd
88-19mm	19mm	6583	I	57.15	36.58	50.93	11.10
88-21mm	21mm	6583	I	57.15	36.58	50.93	11.71
88-22mm	22mm	6583	I	61.14	38.89	50.93	12.45
88-23mm	23mm	6583	I	61.93	39.70	50.93	12.70
88-24mm	24mm	6583	I	61.93	39.70	50.93	14.00
88-26mm	26mm	6583	I	64.26	42.06	50.93	14.61
88-27mm	27mm	6583	I	65.10	44.45	50.93	15.90
88-28mm	28mm	6583	I	65.10	46.02	50.93	16.26
88-29mm	29mm	6583	I	65.10	46.02	50.93	16.66
88-30mm	30mm	6583	I	68.28	50.17	52.53	16.66
88-32mm	32mm	6583	II	68.28	52.53	-	19.05
88-33mm	33mm	6583	II	68.28	52.53	-	19.43
88-34mm	34mm	6583	II	68.28	52.53	-	20.02
88-35mm	35mm	6581A	III	68.28	57.15	53.59	20.12
88-36mm	36mm	6581A	III	68.28	57.15	53.59	21.46
88-37mm	37mm	6581A	III	68.28	57.15	53.59	22.28
88-38mm	38mm	6581A	III	68.28	57.15	53.59	22.28
88-41mm	41mm	6584	III	68.28	63.50	56.77	24.92
88-42mm	42mm	6584	III	68.28	63.50	56.77	25.40
88-43mm	43mm	6584	III	68.28	63.50	56.77	25.40
88-46mm	46mm	6585	III	68.28	69.85	61.47	28.63
88-47mm	47mm	6585	III	70.99	69.85	61.47	29.13
88-48mm	48mm	6585	III	70.99	69.85	61.47	29.51
88-50mm	50mm	6585	III	76.20	75.69	61.47	30.00
88-52mm	52mm	6585	III	76.20	75.69	61.47	30.99
88-54mm	54mm	6585	III	76.20	80.26	61.47	30.96
88-55mm	55mm	6585	III	80.90	82.55	61.47	33.55
88-56mm	56mm	6585	III	80.90	82.55	61.47	34.93
88-58mm	58mm	6585	III	80.90	86.36	61.47	35.03
88-60mm	60mm	6585	III	82.17	88.90	61.47	35.41
88-65mm	65mm	6586	III	84.20	94.23	69.47	38.35
88-70mm	70mm	6586	III	90.50	97.28	69.47	41.30
88-75mm	75mm	6586	III	95.25	101.98	69.47	44.25
88-80mm	80mm	6586	III	100.03	106.05	69.47	47.19
88-85mm	85mm	6586	III	106.38	115.32	69.47	50.14
88-90mm	90mm	6586	III	109.60	120.52	69.47	53.11
88-95mm	95mm	6587	III	127.00	127.13	82.55	56.06
88-100mm	100mm	6587	III	134.92	133.22	82.55	59.00
88-110mm	110mm	6587	III	142.24	143.89	82.55	64.90
88-115mm	115mm	6587	III	142.88	147.45	82.55	67.84

Meets or exceeds ASME B107.110

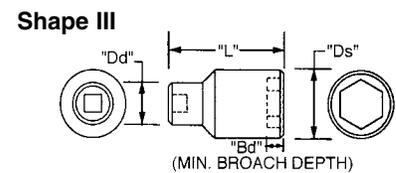
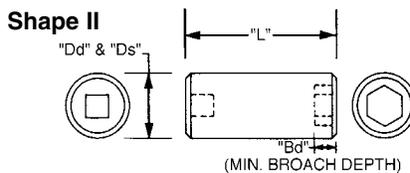
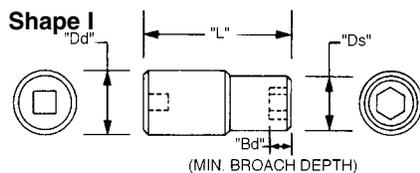



⑥ Pt. Deep Impact Sockets



Part No.	Nom. Size	Ret-Ring Shape	L	Ds	Dd	Bd	
8924	3/4"	6583	I	4"	1-7/16"	2"	7/16"
8926	13/16"	6583	I	4"	1-7/16"	2"	29/64"
8928	7/8"	6583	I	4"	1-17/32"	2"	1/2"
8930	15/16"	6583	I	4"	1-9/16"	2"	1/2"
8932	1"	6583	I	4"	1-21/32"	2"	35/64"
8933	1-1/16"	6583	I	4"	1-3/4"	2"	5/8"
8936	1-1/8"	6583	I	4"	1-13/16"	2"	21/32"
8938	1-3/16"	6583	I	4"	1-31/32"	2-1/16"	21/32"
8939	1-1/4"	6583	II	4"	2-1/16"	—	3/4"
8942	1-5/16"	6583	II	4"	2-1/16"	—	49/64"
8944	1-3/8"	6581A	III	4"	2-1/4"	2-1/8"	25/32"
8946	1-7/16"	6581A	III	4"	2-1/4"	2-1/8"	7/8"
8948	1-1/2"	6581A	III	4"	2-1/4"	2-1/8"	55/64"
8950	1-9/16"	6584	III	4"	2-1/2"	2-1/4"	55/64"
8952	1-5/8"	6584	III	4"	2-1/2"	2-1/4"	1"
8954	1-11/16"	6584	III	4"	2-1/2"	2-1/4"	1"
8956	1-3/4"	6585	III	4-1/16"	2-3/4"	2-7/16"	1-3/32"
8958	1-13/16"	6585	III	4-1/8"	2-3/4"	2-7/16"	1-1/8"
8960	1-7/8"	6585	III	4-3/16"	2-3/4"	2-7/16"	1-1/8"
8962	1-5/16"	6585	III	4-1/4"	2-63/64"	2-7/16"	1-1/8"
8964	2"	6585	III	4-5/16"	2-63/64"	2-7/16"	1-7/32"
8966	2-1/16"	6585	III	4-3/8"	2-63/64"	2-7/16"	1-7/32"
8968	2-1/8"	6585	III	4-7/16"	3-5/32"	2-7/16"	1-7/32"
8970	2-3/16"	6585	III	4-1/2"	3-1/4"	2-7/16"	1-3/8"
8972	2-1/4"	6585	III	4-21/32"	3-1/4"	2-7/16"	1-3/8"
8974	2-5/16"	6585	III	4-23/32"	3-13/32"	2-7/16"	1-3/8"
8976	2-3/8"	6585	III	4-3/4"	3-1/2"	2-7/16"	1-3/8"
8980	2-1/2"	6585	III	4-7/8"	3-19/32"	2-7/16"	1-3/8"
8981	2-9/16"	6586	III	4-7/8"	3-23/32"	2-3/4"	1-3/8"
8988	2-3/4"	6586	III	5"	3-53/64"	2-3/4"	1-3/4"
8990	2-13/16"	6586	III	5"	4"	2-3/4"	1-3/4"
8992	2-7/8"	6586	III	5"	4"	2-3/4"	1-3/4"
8994	2-15/16"	6586	III	5"	4"	2-3/4"	1-3/4"
8996	3"	6586	III	5"	4-3/16"	2-3/4"	2"
89100	3-1/8"	6586	III	5-1/2"	4-3/16"	2-3/4"	1-15/16"
89104	3-1/4"	6586	III	5-5/8"	4-17/32"	2-3/4"	2"
89108	3-3/8"	6586	III	5-3/4"	4-17/32"	2-3/4"	2"
89112	3-1/2"	6586	III	6"	4-3/4"	2-3/4"	2-13/64"
89116	3-5/8"	6587	III	6-1/8"	4-55/64"	3-1/4"	2-1/2"
89120	3-3/4"	6587	III	6-1/4"	5"	3-1/4"	2-1/2"
89124	3-7/8"	6587	III	6-3/8"	5-7/64"	3-1/4"	2-1/2"
89128	4"	6587	III	6-1/2"	5-1/4"	3-1/4"	2-1/2"
89132	4-1/8"	6587	III	6-3/4"	5-3/8"	3-1/4"	2-19/32"
89136	4-1/4"	6587	III	7"	5-17/32"	3-1/4"	2-3/4"
89144	4-1/2"	6587	III	7-1/4"	5-13/16"	3-1/4"	2-27/32"

Meets or exceeds ASME B107.110



1" Sockets, Ratchets & Attachments

Refer to socket dimensional drawings on page 225.



▲ WARNING
Wear safety goggles user and bystander.



▲ WARNING
Before using tools, read safety information on pages 399-403.



▲ WARNING
Comfort or plastic grips do not protect against electric shock.



12 Pt. Deep Impact Sockets



Part No.	Nom. Size	Ret-Ring	Shape	L	Ds	Dd	Bd
8982	1"	6583	I	4"	1-3/4"	2"	35/64"
8986	1-1/8"	6583	I	4"	1-13/16"	2"	21/32"

Meets or exceeds ASME B107.110



6 Pt. Deep Metric Impact Sockets



Part No.	Nom. Size	Ret-Ring	Shape	L	Ds	Dd	Bd
89-23mm	23mm	6583	I	101.60	39.70	50.93	12.70
89-24mm	24mm	6583	I	101.60	39.70	50.93	14.00
89-27mm	27mm	6583	I	101.60	44.45	50.93	15.90
89-28mm	28mm	6583	I	101.60	46.02	50.93	16.26
89-30mm	30mm	6583	I	101.60	50.17	52.53	16.66
89-32mm	32mm	6583	II	101.60	52.53	-	19.05
89-33mm	33mm	6583	II	101.60	52.53	-	19.43
89-34mm	34mm	6583	II	101.60	52.53	-	20.02
89-35mm	35mm	6581A	III	101.60	57.15	53.59	20.12
89-36mm	36mm	6581A	III	101.60	57.15	53.59	21.46
89-37mm	37mm	6581A	III	101.60	57.15	53.59	22.28
89-38mm	38mm	6581A	III	101.60	57.15	53.59	22.28
89-41mm	41mm	6584	III	101.60	63.50	56.77	24.92
89-42mm	42mm	6584	III	101.60	63.50	56.77	25.40
89-43mm	43mm	6584	III	101.60	63.50	56.77	25.40
89-46mm	46mm	6585	III	104.78	69.85	61.47	28.63
89-47mm	47mm	6585	III	104.78	69.85	61.47	29.13
89-50mm	50mm	6585	III	107.95	75.69	61.47	30.00
89-52mm	52mm	6585	III	111.13	75.69	61.47	30.99
89-55mm	55mm	6585	III	114.30	82.55	61.47	33.55
89-56mm	56mm	6585	III	117.48	82.55	61.47	34.93
89-60mm	60mm	6585	III	120.65	88.90	61.47	35.41
89-65mm	65mm	6586	III	123.83	94.23	69.47	38.35
89-70mm	70mm	6586	III	127.00	97.28	69.47	41.30
89-75mm	75mm	6586	III	133.35	101.98	69.47	44.25
89-80mm	80mm	6586	III	139.70	106.05	69.47	47.19
89-85mm	85mm	6586	III	146.05	115.32	69.47	50.14
89-90mm	90mm	6586	III	152.40	120.52	69.47	53.11
89-95mm	95mm	6587	III	158.75	127.13	82.55	56.06
89-100mm	100mm	6587	III	165.10	133.22	82.55	59.00
89-105mm	105mm	6587	III	171.45	136.78	82.55	61.95
89-110mm	110mm	6587	III	177.80	143.89	82.55	64.90
89-115mm	115mm	6587	III	184.15	147.45	82.55	67.84

Meets or exceeds ASME B107.110





8 Pt. Double Square Impact (Railroad) Sockets



Part No.	Nom. Size	Ret-Ring	Shape	L	Ds	Dd	Bd
8807	7/8"	6583	I	2-9/16"	1-3/4"	2"	1/2"
8808	1"	6583	II	2-11/16"	2-1/16"	-	35/64"
8809	1-1/8"	6583	III	2-11/16"	2-1/4"	2-1/16"	21/32"
8810	1-3/16"	6583	III	2-11/16"	2-1/4"	2-1/16"	21/32"
8810A	1-5/16"	6583	III	2-11/16"	2-1/2"	2-1/16"	49/64"
8811	1-3/8"	6583	III	2-11/16"	2-1/2"	2-1/16"	25/32"
8811A	1-7/16"	6584	III	2-11/16"	2-3/4"	2-5/16"	7/8"
8812	1-1/2"	6584	III	2-11/16"	2-3/4"	2-5/16"	55/64"
8813	1-5/8"	6584	III	3-1/2"	3-1/16"	2-5/16"	1"
8815	1-13/16"	6585	III	3-1/2"	3-1/4"	2-7/16"	1-1/8"
8816A	2"	6585	III	3-1/2"	3-1/2"	2-7/16"	1-7/32"
8817	2-3/16"	6586	III	3-1/2"	3-3/4"	2-3/4"	1-3/8"



Meets or exceeds ASME B107.110

8 Pt. Double Square Deep Impact (Railroad) Sockets



Part No.	Nom. Size	Ret-Ring	Shape	L	Ds	Dd	Bd
8924R	3/4"	6583	I	4"	1-21/32"	2"	7/16"
8928R	7/8"	6583	I	4"	1-13/16"	2"	1/2"
8934R	1-1/16"	6583	II	4"	2-1/16"	-	5/8"
8936R	1-1/8"	6581A	III	4"	2-1/4"	2-1/8"	21/32"
8938R	1-3/16"	6581A	III	4"	2-1/4"	2-1/8"	21/32"
8942R	1-5/16"	6584	III	4"	2-1/2"	2-1/4"	49/64"
8946R	1-7/16"	6585	III	4"	2-3/4"	2-7/16"	7/8"
8952R	1-5/8"	6585	III	4"	2-63/64"	2-7/16"	1"
8970R	2-3/16"	6586	III	4-1/2"	3-53/64"	2-3/4"	1-3/8"



Meets or exceeds ASME B107.110

Shape I

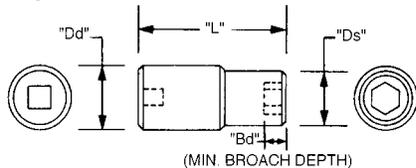

Shape II

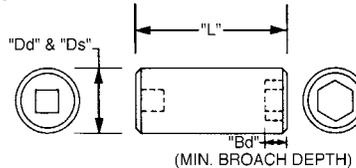

Shape III

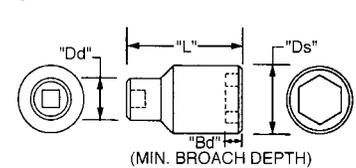

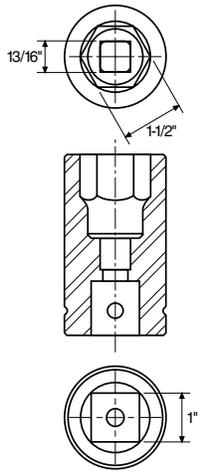

8991



8893 & 8995



Budd Wheel Impact Sockets

Part No.	Nom. Size	Ret-Ring	Shape	L	Ds	Dd	Bd
8893	13/16" Sq. Std. Length Budd Wheels	6583	II	2-9/32"	2"	-	9/16"
8991	1-1/2" Hex x 13/16" Sq. Long Length Comb. Socket Budd Wheels	6584	II	3-3/16"	2-1/4"	-	19/32"
8995	15/16" Sq. Std. Length Budd Wheels	6583	II	2-9/16"	2"	-	5/8"

Meets or exceeds ASME B107.110

Square Budd Wheel Metric Impact Sockets

Part No.	Nom. Size	Ret-Ring	Shape	L	Ds	Dd	Bd
88-87mm	17mm sq.	6583	II	65.10	50.80	-	15.88
88-91mm	21mm sq.	6583	II	65.10	50.80	-	15.88

Meets or exceeds ASME B107.110

Shape I

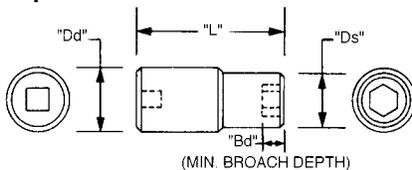

Shape II

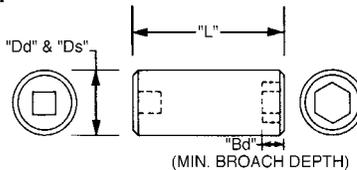

Shape III

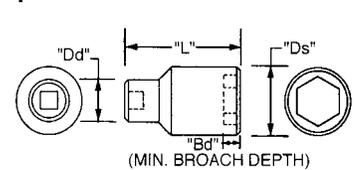



WRIGHT TOOL
PERFECTING PERFORMANCE

We Have The

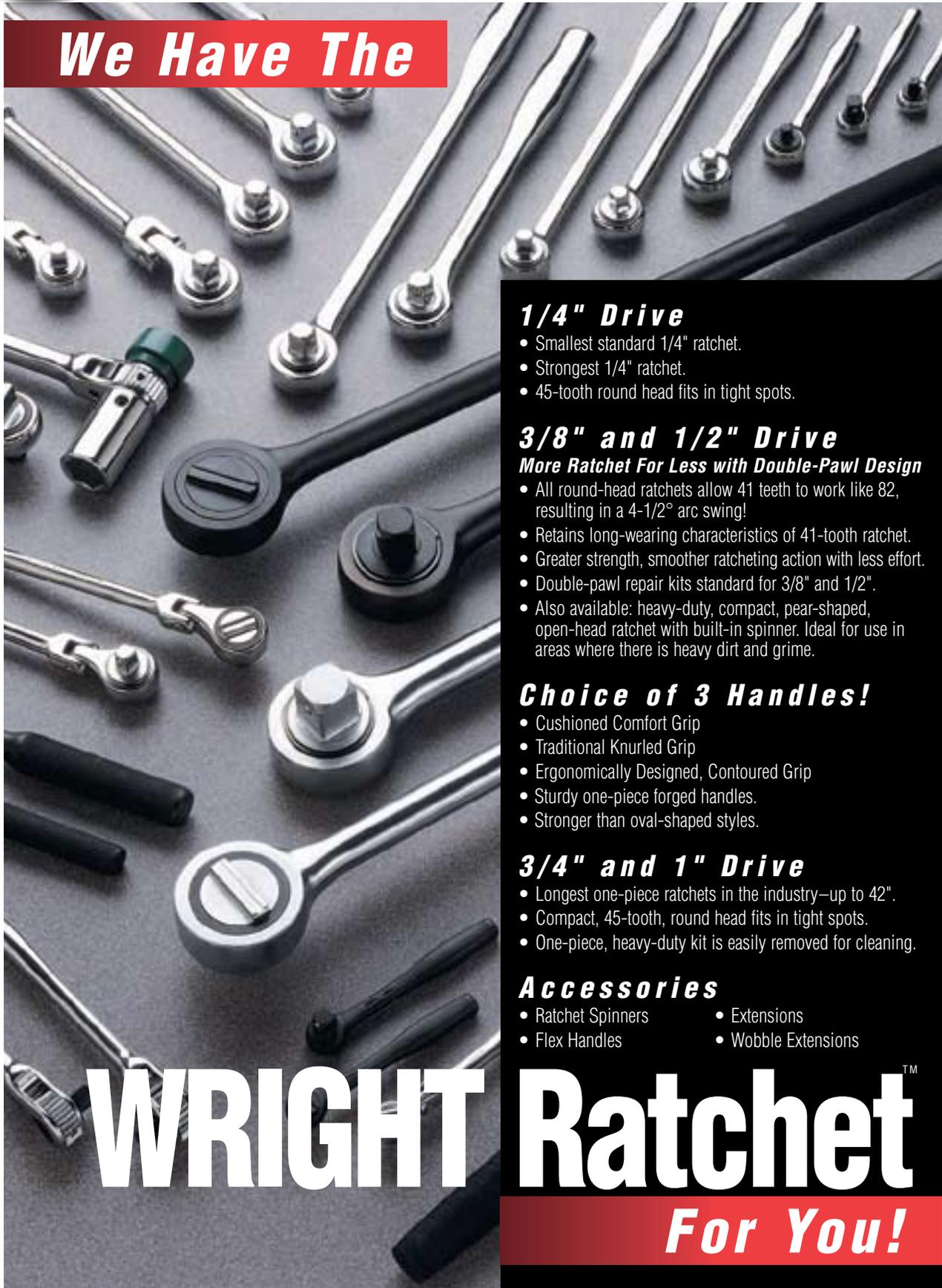

1/4" Drive

- Smallest standard 1/4" ratchet.
- Strongest 1/4" ratchet.
- 45-tooth round head fits in tight spots.

3/8" and 1/2" Drive

More Ratchet For Less with Double-Pawl Design

- All round-head ratchets allow 41 teeth to work like 82, resulting in a 4-1/2° arc swing!
- Retains long-wearing characteristics of 41-tooth ratchet.
- Greater strength, smoother ratcheting action with less effort.
- Double-pawl repair kits standard for 3/8" and 1/2".
- Also available: heavy-duty, compact, pear-shaped, open-head ratchet with built-in spinner. Ideal for use in areas where there is heavy dirt and grime.

Choice of 3 Handles!

- Cushioned Comfort Grip
- Traditional Knurled Grip
- Ergonomically Designed, Contoured Grip
- Sturdy one-piece forged handles.
- Stronger than oval-shaped styles.

3/4" and 1" Drive

- Longest one-piece ratchets in the industry—up to 42".
- Compact, 45-tooth, round head fits in tight spots.
- One-piece, heavy-duty kit is easily removed for cleaning.

Accessories

- Ratchet Spinners
- Extensions
- Flex Handles
- Wobble Extensions

WRIGHT Ratchet™

For You!

1"

Sockets, Ratchets & Attachments





1" Hex Impact Drivers, One Piece

Part No.	Nom. Size	Ret-Ring	O.D.	Length
8220	5/8	6583	1-55/64"	3-1/4"
8224	3/4	6583	1-55/64"	3-1/4"
8228	7/8	6583	1-55/64"	3-1/4"
8232	1"	6583	1-55/64"	3-1/4"
8240	1-1/4"	6583	1-55/64"	3-1/4"

Meets or exceeds ASME B107.110

1-1/2" Impact Attachments



Impact Adaptors

Part No.	Description	Ret-Ring	Length
84900	1-1/2" F x 1" M	84575	4-5/16"
84901	1-1/2" F x 2-1/2" M	84575	4-3/8"

Guarantee does not apply
Meets or exceeds ASME B107.110



Impact Universal

Part No.	Dia.	Overall Length	Ret-Ring
84800	3-5/8"	8-1/4"	84575

Meets or exceeds ASME B107.110



Impact Extensions

Part No.	Description	Ret-Ring
84908	8"	84575
84912	12"	84575
84915	15"	84575

Meets or exceeds ASME B107.110



1"
1-1/2"



Sockets, Ratchets & Attachments



1-1/2" Drive Ret-Ring™ One-Piece Socket Retainers

Part No.	I.D.
84575	3"
84576	3-3/8"
84577	3-7/8"
84578	4-3/8"

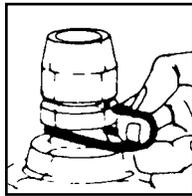
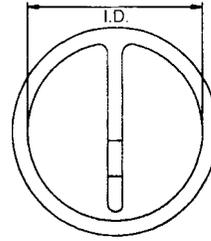

Step 1

Place Socket Retainer over square driver. Place Socket on square driver aligning retention holes. Hold center pin of Retainer between thumb and index finger, and insert it through retention holes.

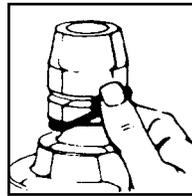

Step 2

Push center pin of Socket Retainer all the way in.

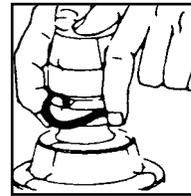

Step 3

Pull O-ring of Socket Retainer up into groove on Socket.

1-1/2"



Sockets, Ratchets & Attachments



1-1/2" Drive Impact Sockets



⑥ Pt. Standard Impact Sockets



Part No.	Nom. Size	Ret-Ring	Shape	L	Ds	Dd	Bd
84822	1-3/8"	84575	I	3-1/8"	2-3/4"	3-1/4"	25/32"
84823	1-7/16"	84575	I	3-3/16"	2-3/4"	3-1/4"	7/8"
84824	1-1/2"	84575	I	3-1/4"	2-7/8"	3-1/4"	15/16"
84825	1-9/16"	84575	I	3-1/4"	2-7/8"	3-1/4"	1"
84826	1-5/8"	84575	I	3-1/4"	3"	3-1/4"	1-1/16"
84827	1-11/16"	84575	I	3-1/4"	3"	3-1/4"	1-1/16"
84828	1-3/4"	84575	I	3-3/8"	3-1/8"	3-1/4"	1-1/8"
84829	1-13/16"	84575	I	3-3/8"	3-1/8"	3-1/4"	1-5/32"
84830	1-7/8"	84575	I	3-5/8"	3-1/8"	3-1/4"	1-3/16"
84831	1-15/16"	84575	I	3-5/8"	3-1/8"	3-1/4"	1-7/32"
84832	2"	84575	II	3-3/4"	3-9/32"	-	1-1/4"
84833	2-1/16"	84575	II	3-3/4"	3-9/32"	-	1-5/16"
84834	2-1/8"	84575	II	3-3/4"	3-1/2"	-	1-11/32"
84835	2-3/16"	84575	II	3-13/16"	3-1/2"	-	1-3/8"
84836	2-1/4"	84576	II	3-7/8"	3-3/4"	-	1-13/32"
84837	2-5/16"	84576	II	3-15/16"	3-3/4"	-	1-15/32"
84838	2-3/8"	84576	II	4"	3-3/4"	-	1-1/2"
84839	2-7/16"	84576	III	4-1/16"	3-7/8"	3-3/4"	1-9/16"
84840	2-1/2"	84576	III	4-1/8"	3-7/8"	3-3/4"	1-19/32"
84841	2-9/16"	84576	III	4-3/16"	4"	3-3/4"	1-5/8"
84842	2-5/8"	84576	III	4-1/4"	4"	3-3/4"	1-21/32"
84843	2-11/16"	84576	III	4-5/16"	4-1/8"	3-3/4"	1-11/16"
84844	2-3/4"	84576	III	4-3/8"	4-7/32"	3-3/4"	1-3/4"
84845	2-13/16"	84576	III	4-7/16"	4-7/32"	3-3/4"	1-25/32"
84846	2-7/8"	84576	III	4-1/2"	4-31/64"	3-3/4"	1-13/16"
84847	2-15/16"	84576	III	4-17/32"	4-31/64"	3-3/4"	1-27/32"
84848	3"	84576	III	4-5/8"	4-23/32"	3-3/4"	2"
84849	3-1/16"	84576	III	4-11/16"	4-23/32"	3-3/4"	2"
84850	3-1/8"	84576	III	4-3/4"	4-23/32"	3-3/4"	2"
84851	3-3/16"	84576	III	4-3/4"	4-23/32"	3-3/4"	2"
84852	3-1/4"	84576	III	4-7/8"	4-63/64"	3-3/4"	2-1/16"
84853	3-5/16"	84576	III	4-7/8"	4-63/64"	3-3/4"	2-3/32"
84854	3-3/8"	84576	III	4-15/16"	4-63/64"	3-3/4"	2-7/32"
84855	3-7/16"	84576	III	5"	4-63/64"	3-3/4"	2-7/32"
84856	3-1/2"	84576	III	5-1/8"	5-3/32"	3-3/4"	2-1/4"
84857	3-9/16"	84576	III	5-1/8"	5-3/32"	3-3/4"	2-1/4"
84858	3-5/8"	84576	III	5-3/16"	5-3/16"	3-3/4"	2-9/32"
84859	3-11/16"	84576	III	5-1/4"	5-3/16"	3-3/4"	2-11/32"
84860	3-3/4"	84576	III	5-1/4"	5-15/32"	3-3/4"	2-3/8"



Part No.	Nom. Size	Ret-Ring	Shape	L	Ds	Dd	Bd
84861	3-13/16"	84576	III	5-1/4"	5-1/2"	3-3/4"	2-7/16"
84862	3-7/8"	84576	III	5-3/8"	5-1/2"	3-3/4"	2-1/2"
84863	3-15/16"	84576	III	5-1/2"	5-3/4"	3-3/4"	2-1/2"
84864	4"	84576	III	5-1/2"	5-3/4"	3-3/4"	2-1/2"
84865	4-1/16"	84578	III	5-1/2"	5-3/4"	5"	2-5/8"
84866	4-1/8"	84578	III	5-5/8"	6"	5"	2-5/8"
84867	4-3/16"	84578	III	5-5/8"	6"	5"	2-5/8"
84868	4-1/4"	84578	III	5-3/4"	6"	5"	2-3/4"
84869	4-5/16"	84578	III	5-3/4"	6"	5"	2-3/4"
84870	4-3/8"	84578	III	5-3/4"	6-13/64"	5"	2-3/4"
84871	4-7/16"	84578	III	5-7/8"	6-13/64"	5"	2-7/8"
84872	4-1/2"	84578	III	5-7/8"	6-13/64"	5"	2-7/8"
84874	4-5/8"	84578	III	6-1/8"	6-3/8"	5"	3"
84876	4-3/4"	84578	III	6-1/8"	6-3/8"	5"	3"
84878	4-7/8"	84578	III	6-1/4"	6-5/8"	5"	3"
84882	5-1/8"	84578	III	6-3/8"	6-59/64"	5"	3"
84884	5-1/4"	84578	III	6-1/2"	7-1/16"	5"	3-1/8"
84886	5-3/8"	84578	III	6-1/2"	7-13/64"	5"	3-1/8"
84888	5-1/2"	84578	III	6-5/8"	7-11/32"	5"	3-1/4"
84896	6"	85578	III	6-7/8"	7-15/16"	6"	3-1/2"
		"O" ring					
848104	6-1/2"	85579	III	7"	8-33/64"	6"	3-5/8"
		Pin					

1-1/2"



Sockets, Ratchets & Attachments

Meets or exceeds ASME B107.110

Refer to socket dimensional drawings on page 234.





⑥ Pt. Standard Metric Impact Sockets



Part No.	Nom. Size	Ret-Ring Shape	L	Ds	Dd	Bd
848-41mm	41mm	84575	I	82.17	71.12	82.68 24.92
848-42mm	42mm	84575	I	82.17	77.22	82.68 25.40
848-43mm	43mm	84575	I	85.34	78.23	82.68 25.40
848-46mm	46mm	84575	I	85.34	81.41	82.68 28.63
848-47mm	47mm	84575	I	92.46	82.30	82.68 29.13
848-48mm	48mm	84575	I	92.46	83.31	82.68 29.51
848-50mm	50mm	84575	II	94.87	85.47	- 30.00
848-52mm	52mm	84575	II	94.87	87.63	- 30.99
848-55mm	55mm	84575	II	97.28	90.93	- 33.55
848-56mm	56mm	84575	II	98.43	91.95	- 34.93
848-60mm	60mm	84575	II	101.98	96.52	- 35.41
848-65mm	65mm	84576	III	105.92	101.60	95.25 38.35
848-70mm	70mm	84576	III	111.51	107.19	95.25 41.30
848-75mm	75mm	84576	III	115.06	113.79	95.25 44.25
848-80mm	80mm	84576	III	121.03	119.63	95.25 47.19
848-85mm	85mm	84576	III	125.86	125.48	95.25 50.14
848-90mm	90mm	84576	III	130.56	131.32	95.25 53.11
848-95mm	95mm	84576	III	135.38	137.16	95.25 56.06
848-100mm	100mm	84576	III	139.83	143.00	95.25 59.00
848-105mm	105mm	84578	III	142.88	148.72	127.00 61.95
848-110mm	110mm	84578	III	146.69	154.43	127.00 64.90
848-115mm	115mm	84578	III	149.99	160.02	127.00 67.84
848-120mm	120mm	84578	III	156.08	165.74	127.00 70.79
848-125mm	125mm	84578	III	158.62	171.45	127.00 73.76
848-130mm	130mm	84578	III	161.80	177.17	127.00 76.71
848-135mm	135mm	84578	III	164.97	182.88	127.00 79.65
848-140mm	140mm	84578	III	168.15	188.60	127.00 82.60
848-145mm	145mm	84578	III	171.32	194.31	127.00 85.55
848-150mm	150mm	84578	III	174.50	200.03	127.00 88.49
848-155mm	155mm	84578	III	177.67	205.74	127.00 91.44



Meets or exceeds ASME B107.110

⑫ Pt. Standard Impact Sockets



Part No.	Nom. Size	Ret-Ring Shape	L	Ds	Dd	Bd
84723	1-7/16"	84575	I	3-3/16"	2-3/4"	3-1/4" 7/8"
84724	1-1/2"	84575	I	3-1/4"	2-7/8"	3-1/4" 15/16"
84727	1-11/16"	84575	I	3-1/4"	3"	3-1/4" 1-1/16"
84728	1-3/4"	84575	I	3-3/8"	3-1/8"	3-1/4" 1-1/8"
84733	2-1/16"	84575	II	3-3/4"	3-1/4"	- 1-5/16"
84738	2-3/8"	84575	II	4"	3-3/4"	- 1-1/2"
84743	2-11/16"	84576	III	4-9/32"	4-3/32"	3-3/4" 1-11/16"
84748	3"	84576	III	4-5/8"	4-23/32"	3-3/4" 2"
84750	3-1/8"	84576	III	4-3/4"	4-23/32"	3-3/4" 2"



Meets or exceeds ASME B107.110

Shape I

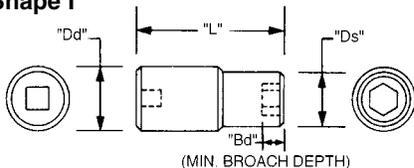

Shape II

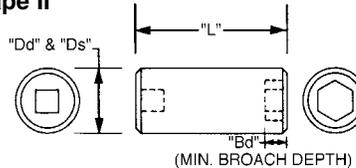

Shape III

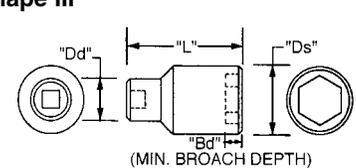

1-1/2"



Sockets, Ratchets & Attachments



⑥ Pt. Deep Impact Sockets



Part No.	Nom. Size	Ret-Ring	Shape	L	Ds	Dd	Bd
84922	1-3/8"	84575	I	5-11/16"	2-3/4"	3-1/4"	13/16"
84923	1-7/16"	84575	I	5-11/16"	2-3/4"	3-1/4"	7/8"
84924	1-1/2"	84575	I	5-11/16"	2-7/8"	3-1/4"	7/8"
84925	1-9/16"	84575	I	5-11/16"	2-7/8"	3-1/4"	1"
84926	1-5/8"	84575	I	5-11/16"	3"	3-1/4"	1-1/16"
84927	1-11/16"	84575	I	5-11/16"	3"	3-1/4"	1-1/16"
84928	1-3/4"	84575	I	5-11/16"	3-1/8"	3-1/4"	1-1/8"
84929	1-13/16"	84575	I	5-11/16"	3-1/8"	3-1/4"	1-1/8"
84930	1-7/8"	84575	I	5-11/16"	3-1/8"	3-1/4"	1-3/16"
84931	1-15/16"	84575	I	5-11/16"	3-1/8"	3-1/4"	1-7/32"
84932	2"	84575	II	5-11/16"	3-9/32"	-	1-1/4"
84933	2-1/16"	84575	II	5-11/16"	3-9/32"	-	1-5/16"
84934	2-1/8"	84575	II	5-11/16"	3-1/2"	-	1-3/8"
84935	2-3/16"	84575	II	5-11/16"	3-1/2"	-	1-3/8"
84936	2-1/4"	84576	II	6-1/16"	3-3/4"	-	1-7/16"
84937	2-5/16"	84576	II	6-1/16"	3-3/4"	-	1-15/32"
84938	2-3/8"	84576	II	6-1/16"	3-3/4"	-	1-1/2"
84939	2-7/16"	84576	III	6-1/16"	3-7/8"	3-3/4"	1-9/16"
84940	2-1/2"	84576	III	6-1/16"	3-7/8"	3-3/4"	1-19/32"
84941	2-9/16"	84576	III	6-1/16"	4"	3-3/4"	1-5/8"
84942	2-5/8"	84576	III	6-1/16"	4"	3-3/4"	1-11/16"
84943	2-11/16"	84576	III	6-1/16"	4-1/8"	3-3/4"	1-11/16"
84944	2-3/4"	84576	III	6-1/16"	4-7/32"	3-3/4"	1-3/4"
84945	2-13/16"	84576	III	6-5/16"	4-7/32"	3-3/4"	1-25/32"
84946	2-7/8"	84576	III	6-5/16"	4-15/32"	3-3/4"	1-13/16"
84947	2 15/16"	84576	III	6-5/16"	4-15/32"	3-3/4"	1-27/32"
84948	3"	84576	III	6-5/16"	4-23/32"	3-3/4"	2"
84949	3-1/16"	84576	III	6-5/16"	4-23/32"	3-3/4"	2"
84950	3-1/8"	84576	III	6-5/16"	4-23/32"	3-3/4"	2"
84951	3-3/16"	84576	III	6-7/16"	4-23/32"	3-3/4"	2"
84952	3-1/4"	84576	III	6-7/16"	4-31/32"	3-3/4"	2-1/16"
84953	3-5/16"	84576	III	6-7/16"	4-31/32"	3-3/4"	2-3/32"
84954	3-3/8"	84576	III	6-7/16"	4-31/32"	3-3/4"	2-1/8"
84955	3-7/16"	84576	III	6-7/16"	4-31/32"	3-3/4"	2-5/32"
84956	3-1/2"	84576	III	6-7/16"	5-7/64"	3-3/4"	2-1/4"



Part No.	Nom. Size	Ret-Ring	Shape	L	Ds	Dd	Bd
84957	3-9/16"	84576	III	6-7/16"	5-7/64"	3-3/4"	2-1/4"
84958	3-5/8"	84576	III	6-13/16"	5-13/64"	3-3/4"	2-9/32"
84959	3-11/16"	84576	III	6-13/16"	5-13/64"	3-3/4"	2-11/32"
84960	3-3/4"	84576	III	6-13/16"	5-15/32"	3-3/4"	2-3/8"
84961	3-13/16"	84576	III	6-13/16"	5-1/2"	3-3/4"	2-13/32"
84962	3-7/8"	84576	III	7-1/16"	5-1/2"	3-3/4"	2-1/2"
84963	3-15/16"	84576	III	7-1/16"	5-3/4"	3-3/4"	2-1/2"
84964	4"	84576	III	7-1/16"	5-3/4"	3-3/4"	2-1/2"
84965	4-1/16"	84578	III	7-1/16"	5-3/4"	5"	2-5/8"
84966	4-1/8"	84578	III	7-13/16"	6"	5"	2-5/8"
84967	4-3/16"	84578	III	7-13/16"	6"	5"	2-5/8"
84968	4-1/4"	84578	III	7-13/16"	6"	5"	2-3/4"
84969	4-5/16"	84578	III	7-13/16"	6"	5"	2-3/4"
84970	4-3/8"	84578	III	7-13/16"	6-7/32"	5"	2-3/4"
84971	4-7/16"	84578	III	7-13/16"	6-7/32"	5"	2-7/8"
84972	4-1/2"	84578	III	7-13/16"	6-7/32"	5"	2-7/8"
84974	4-5/8"	84578	III	7-13/16"	6-3/8"	5"	3"
84976	4-3/4"	84578	III	7-13/16"	6-3/8"	5"	3"
84980	5"	84578	III	7-13/16"	6-49/64"	5"	3"

1-1/2"



Sockets, Ratchets & Attachments

Meets or exceeds ASME B107.110

Refer to socket dimensional drawings on page 234.

*Note: Limited Quantities, call Wright Tool for delivery.





⑥ Pt. Metric Deep Impact Sockets



Part No.	Flats (mm)	Ret-Ring	Shape	L	Ds	Dd	Bd
849-41mm	41mm	84575	I	144.22	76.20	82.68	24.92
849-42mm	42mm	84575	I	144.22	76.20	82.68	25.40
849-43mm	43mm	84575	I	144.22	79.38	82.68	25.40
849-46mm	46mm	84575	I	144.22	79.38	82.68	28.63
849-50mm	50mm	84575	II	144.22	83.19	-	30.00
849-52mm	52mm	84575	II	144.22	83.19	-	30.99
849-55mm	55mm	84575	II	144.22	86.49	-	33.55
849-56mm	56mm	84575	II	153.75	87.25	-	36.07
849-60mm	60mm	84575	II	153.75	91.57	-	35.41
849-65mm	65mm	84576	III	153.75	97.92	95.25	38.35
849-70mm	70mm	84576	III	153.75	103.38	95.25	41.30
849-75mm	75mm	84576	III	160.10	109.22	95.25	44.25
849-80mm	80mm	84576	III	163.27	115.19	95.25	47.19
849-85mm	85mm	84576	III	163.27	121.16	95.25	50.14
849-90mm	90mm	84576	III	163.27	126.75	95.25	53.11
849-95mm	95mm	84576	III	172.80	132.59	95.25	56.06
849-100mm	100mm	84576	III	179.15	138.43	95.25	59.00
849-105mm	105mm	84576	III	198.20	144.27	95.25	61.95
849-110mm	110mm	84576	III	198.20	149.99	95.25	64.90
849-115mm	115mm	84576	III	198.20	155.45	95.25	67.84
849-120mm	120mm	84576	III	198.20	160.66	95.25	70.79
849-125mm	125mm	84578	III	203.20	166.24	127.00	73.76
849-130mm	130mm	84578	III	203.20	171.83	127.00	76.71

Meets or exceeds ASME B107.110



1-1/2"



Sockets, Ratchets & Attachments

Refer to socket dimensional drawings on page 237.



1-1/2" & 2-1/2" Drive Castellated/Spanner Sockets

WRIGHT TOOL
PERFECTING PERFORMANCE



1-1/2" Drive Castellated/Spanner Sockets



Part No.	Nom. Size	Ret-Ring	Shape	L	Ds	Dd	Bd
848C36	2-1/4"	84576	III	3-3/8"	3-1/2"	3-3/4"	9/16"
848C40	2-1/2"	84576	III	3-7/16"	3-7/8"	3-3/4"	9/16"
848C44	2-3/4"	84576	III	3-1/2"	4-1/4"	3-3/4"	11/16"
848C48	3"	84576	III	3-9/16"	4-5/8"	3-3/4"	11/16"
848C56	3-1/2"	84576	III	3-7/8"	5-3/8"	3-3/4"	15/16"



2-1/2" Drive Castellated/Spanner Sockets

Part No.	Nom. Size	"O" Ring	Retainer Pin	Shape	L	Ds	Dd	Bd
858C18	2-1/4"	85576	85577	I	3-7/8"	3-1/2"	5"	9/16"
858C40	5"	85576	85577	III	5"	7-5/8"	5"	1-1/16"

1-1/2"/
2-1/2"



Sockets, Ratchets & Attachments

Shape I

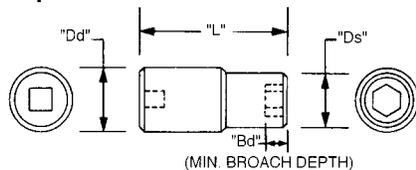

Shape II

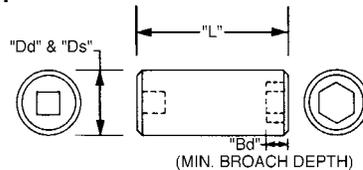

Shape III

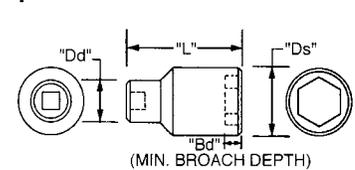

www.wrighttool.com



⑥ Pt. Standard Impact Sockets

Part No.	Nom. Size	"O" Ring	Retainer Pin Shape	L	Ds	Dd	Bd	
85814	1-3/4"	85576	85577	I	5-3/8"	4-15/64"	5"	1-1/8"
85815	1-7/8"	85576	85577	I	5-3/8"	4-5/16"	5"	1-3/16"
85816	2"	85576	85577	I	5-3/8"	4-5/16"	5"	1-1/4"
85817	2-1/8"	85576	85577	I	5-3/8"	4-5/16"	5"	1-3/8"
85818	2-1/4"	85576	85577	I	5-1/2"	4-13/32"	5"	1-7/16"
85819	2-3/8"	85576	85577	I	5-1/2"	4-5/8"	5"	1-1/2"
85820A	2-9/16"	85576	85577	I	5-1/2"	4-5/8"	5"	1-5/8"
85821	2-5/8"	85576	85577	I	5-1/2"	4-23/32"	5"	1-11/16"
85822	2-3/4"	85576	85577	II	5-5/8"	5"	-	1-3/4"
85823	2-15/16"	85576	85577	II	5-5/8"	5"	-	1-7/8"
85824	3"	85576	85577	II	5-5/8"	5"	-	2"
85825	3-1/8"	85576	85577	II	5-3/4"	5-5/16"	-	2"
85826	3-1/4"	85576	85577	II	5-3/4"	5-13/32"	-	2-1/16"
85827	3-3/8"	85576	85577	II	5-3/4"	5-13/32"	-	2-1/8"
85828	3-1/2"	85576	85577	II	5-3/4"	5-1/2"	-	2-1/4"
85829	3-5/8"	85576	85577	II	5-3/4"	5-1/2"	-	2-5/16"
85830	3-3/4"	85578	85579	II	6-1/4"	5-7/8"	-	2-3/8"
85831	3-7/8"	85578	85579	II	6-1/4"	5-63/64"	-	2-1/2"
85832	4"	85578	85579	III	6-1/4"	6-7/32"	6"	2-1/2"
85833	4-1/8"	85578	85579	III	6-1/4"	6-5/16"	6"	2-5/8"
85834	4-1/4"	85578	85579	III	6-3/4"	6-13/32"	6"	2-3/4"
85835	4-3/8"	85578	85579	III	6-3/4"	6-17/32"	6"	2-3/4"
85836	4-1/2"	85578	85579	III	7"	6-5/8"	6"	2-27/32"
85837	4-5/8"	85578	85579	III	7"	6-23/32"	6"	3"
85838	4-3/4"	85578	85579	III	7"	6-13/16"	6"	3"
85839	4-7/8"	85578	85579	III	7-1/4"	6-59/64"	6"	3"
85840	5"	85578	85579	III	7-1/2"	7"	6"	3-1/8"
85841	5-1/8"	85578	85579	III	7-1/2"	7-1/8"	6"	3-5/16"
85842	5-1/4"	85578	85579	III	7-1/2"	7-7/32"	6"	3-5/16"
85843	5-3/8"	85578	85579	III	7-3/4"	7-1/2"	6"	3-3/8"
85844	5-1/2"	85578	85579	III	7-3/4"	7-5/8"	6"	3-15/32"
85845	5-5/8"	85578	85579	III	7-3/4"	7-23/32"	6"	3-9/16"
85846	5-3/4"	85578	85579	III	7-3/4"	7-13/16"	6"	3-5/8"
85849	6-1/8"	85578	85579	III	7-7/8"	8"	6"	3-7/8"
85852	6-1/2"	85578	85579	III	8"	8-31/64"	6"	4"
85854	6-3/4"	85580	85581	III	8"	9-3/8"	6-1/2"	4-5/16"
85855	6-7/8"	85580	85581	III	8"	9-3/8"	6-1/2"	4-5/16"
85861	7-5/8"	85580	85581	III	8-1/2"	9-5/8"	6-1/2"	4-5/16"
85864	8"	85580	85581	III	8-3/4"	9-29/32"	6-1/2"	4-11/32"

Meets or exceeds ASME B107.110



"O" Rings

Part No.	O.D.	I.D.	Width
85576	4-1/2"	4"	1/4"
85578	5-1/2"	5"	1/4"
85580	6"	5-1/2"	1/4"

Retainer Pins

Part No.	O.D.	Length
85577	7/16"	4-3/8"
85579	7/16"	5-3/8"
85581	7/16"	5-7/8"

2-1/2"



Sockets, Ratchets & Attachments





⑥ Pt. Metric Standard Impact Sockets



Part No.	Nom. Size	"O" Ring	Retainer Pin	Shape	L	Ds	Dd	Bd
858-60mm	60mm	85576	85577	I	139.45	117.09	127.25	35.41
858-65mm	65mm	85576	85577	I	139.45	117.09	127.25	38.35
858-70mm	70mm	85576	85577	II	142.62	127.25	—	41.30
858-75mm	75mm	85576	85577	II	142.62	127.25	—	44.25
858-80mm	80mm	85576	85577	II	145.80	127.25	—	47.19
858-85mm	85mm	85576	85577	II	145.80	139.95	—	50.14
858-90mm	90mm	85576	85577	II	145.80	139.95	—	53.11
858-95mm	95mm	85578	85579	II	158.50	149.73	—	56.06
858-100mm	100mm	85578	85579	II	158.50	149.73	—	59.00
858-105mm	105mm	85578	85579	II	158.50	152.91	—	61.95
858-110mm	110mm	85578	85579	III	171.20	162.43	151.89	64.90
858-115mm	115mm	85578	85579	III	177.55	162.43	151.89	67.84
858-120mm	120mm	85578	85579	III	177.55	171.45	151.89	70.79
858-125mm	125mm	85578	85579	III	183.90	178.31	151.89	73.76
858-130mm	130mm	85578	85579	III	190.25	184.66	151.89	76.71
858-135mm	135mm	85578	85579	III	196.60	191.01	151.89	79.65
858-140mm	140mm	85578	85579	III	196.60	197.36	151.89	82.60
858-145mm	145mm	85578	85579	III	196.60	203.71	151.89	85.55
858-150mm	150mm	85578	85579	III	199.77	203.71	151.89	88.49
858-155mm	155mm	85578	85579	III	199.77	209.55	151.89	91.44
858-160mm	160mm	85578	85579	III	202.95	216.41	151.89	94.41
858-165mm	165mm	85578	85579	III	202.95	222.25	151.89	97.36
858-170mm	170mm	85580	85581	III	202.95	228.60	165.10	100.30
858-175mm	175mm	85580	85581	III	202.95	234.95	165.10	103.25
858-180mm	180mm	85580	85581	III	206.12	241.30	165.10	106.20
858-185mm	185mm	85580	85581	III	209.30	244.09	165.10	109.14
858-190mm	190mm	85580	85581	III	212.47	249.17	165.10	112.09
858-200mm	200mm	85580	85581	III	218.82	260.35	165.10	118.01
858-210mm	210mm	85580	85581	III	225.17	269.49	165.10	120.02
858-215mm	215mm	85580	85581	III	228.35	274.96	165.10	120.02
858-225mm	225mm	85580	85581	III	231.52	286.00	165.10	120.02
858-235mm	235mm	85580	85581	III	234.70	297.43	165.10	120.02
858-255mm	255mm	85580	85581	III	241.05	319.02	165.10	120.02

Meets or exceeds ASME B107.110

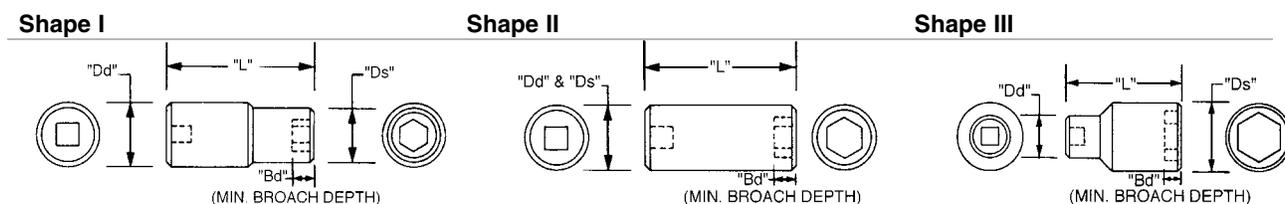



#5 Spline Drive Impact Sockets

Wright Tool spline drive sockets and adaptors are manufactured from 4140 alloy steel and heat treated for maximum strength. Openings are hot forged to close tolerances and the 14 tooth female spline is designed for a snug fit. It also has an internal groove that fits the locking devices on all #5 Spline Drive Impact Wrenches.

Part No. Description

5800 #5 Spline Impact Universal

Meets or exceeds ASME B107.110



#5 Spline Impact Adaptor

Part No. Nom. Size Shape L Ds Dd Bd

5901 #5F x 1"M III 3-21/32" - 2-3/8" -

Warranty does not apply

Meets or exceeds ASME B107.110



Shape I

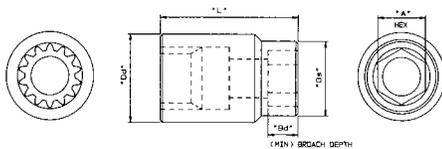

Shape II

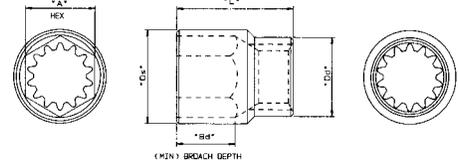

Shape III

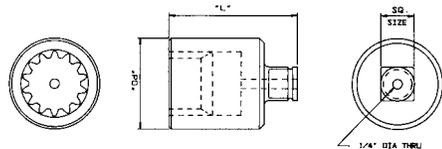

Shape IV

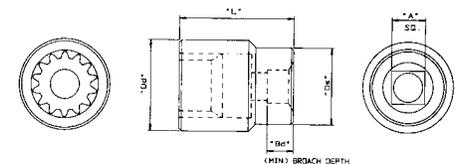

#5 Spline



Sockets, Ratchets & Attachments



#5 Spline Drive 6 Pt. Standard Impact Sockets

Part No.	Nom. Size	Shape	L	Ds	Dd	Bd
5828	7/8"	I	3-1/16"	1-17/32"	2-3/8"	3/4"
5830	15/16"	I	3-1/16"	1-9/16"	2-3/8"	3/4"
5832	1"	I	3-1/16"	1-21/32"	2-3/8"	3/4"
5834	1-1/16"	I	3-1/16"	1-3/4"	2-3/8"	3/4"
5836	1-1/8"	I	3-1/16"	1-13/16"	2-3/8"	3/4"
5838	1-3/16"	I	3-1/16"	1-61/64"	2-3/8"	3/4"
5840	1-1/4"	I	3-1/16"	2-9/64"	2-3/8"	3/4"
5842	1-5/16"	I	3-1/16"	2-9/64"	2-3/8"	7/8"
5844	1-3/8"	I	3-1/16"	2-3/8"	2-3/8"	7/8"
5846	1-7/16"	II	3-1/16"	2-3/8"	2-3/8"	7/8"
5848	1-1/2"	II	3-1/16"	2-9/16"	2-3/8"	7/8"
5852	1-5/8"	II	3-1/16"	2-3/4"	2-7/16"	15/16"
5856	1-3/4"	II	3-1/16"	2-7/8"	2-1/2"	15/16"
5858	1-13/16"	II	3-1/16"	3"	2-1/2"	15/16"
5860	1-7/8"	II	3-1/16"	3"	2-1/2"	15/16"
5864	2"	II	3-1/16"	3-1/8"	2-1/2"	15/16"

Meets or exceeds ASME B107.110



#5 Spline Drive 6 Pt. Deep Impact Sockets

Part No.	Nom. Size	Shape	L	Ds	Dd	Bd
5934	1-1/16"	I	3-3/4"	1-3/4"	2-3/8"	13/16"
5936	1-1/8"	I	3-3/4"	1-13/16"	2-3/8"	13/16"
5938	1-3/16"	I	3-3/4"	2-1/16"	2-3/8"	5/8"
5940	1-1/4"	I	3-3/4"	2-3/32"	2-3/8"	29/32"
5942	1-5/16"	I	3-3/4"	-	2-3/8"	49/64"
5946	1-7/16"	I	3-3/4"	-	2-3/8"	49/64"
5948	1-1/2"	I	3-3/4"	-	2-3/8"	7/8"

Meets or exceeds ASME B107.110



#5 Spline Drive Square Impact Sockets

Part No.	Nom. Size	Shape	L	Ds	Dd	Bd
5993	13/16" sq.	IV	3-1/16"	-	2-3/8"	3/4"
5995	15/16" sq.	IV	3-1/16"	-	2-3/8"	17/32"

Meets or exceeds ASME B107.110

#5 Spline



Sockets, Ratchets & Attachments

Refer to socket dimensional drawings on page 240.



The next step beyond Wright Drive®

WRIGHT SPLINE™



6-Point



12-Point

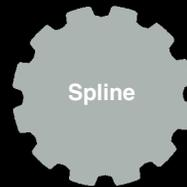

Spline



Wright
Spline™

What Is Wright Spline®?

Wright Spline® is unconventional because it takes advantage of two things that have not previously been considered in wrench design. First, most wrenching problems occur in removing fasteners because the removal torque is frequently twice or more the installation torque. The second point is that many fastener heads are on the small side resulting in substantial play between wrench and fastener. Wright Spline™ is better designed to deal with this clearance.

For further information, contact Wright Tool Customer Service at 800-321-2902, or www.wrighttool.com.

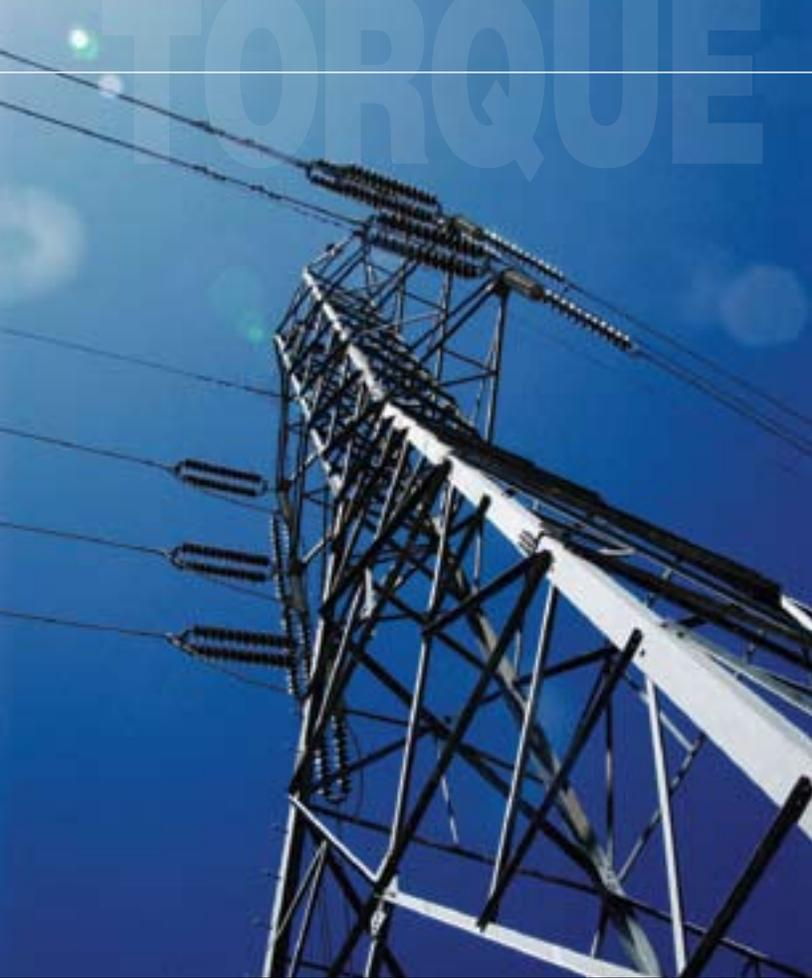

For years, torque wrenches have been the standard for

tightening nuts and bolts that clamp parts together.

Wright offers an extensive line of torque wrenches in four

styles— beam, micro adjustable, dial, and electronic. We

also offer an array of other torque tools, including torque

screwdrivers, torque multipliers and a torque tester.



TORQUE WRENCHES & TOOLS.





W A R N I N G !

TORQUE WRENCHES

- Users and bystanders must wear safety goggles.
- To avoid possible eye injury from flying objects, safety goggles or equivalent protection conforming to ANSI Z87.1 shall be worn and kept clean by the user and all persons in the immediate area where any tool is being used.
- Comfort or plastic grips on handles are not intended to give any degree of protection against electric shock and shall not be used on or near live electric circuits.
- Torque wrenches are a precision instrument. Read the instruction manual completely before using any torque wrench and learn the proper method to operate, maintain and store torque wrenches.
- Torque wrenches are to be used to tighten fasteners only. Do not use torque wrenches to loosen or remove fasteners.
- Users shall apply a controlled force with a stance adjusted and braced to prevent rapid bodily movement or a fall if sudden release occurs.
- Always pull, do not push to apply torque.
- Do not use torque wrenches with sockets or fasteners showing wear or cracks.
- Keep torque wrenches clean. The ratchet mechanism may slip or break if dirty, mismatched or worn parts are used.
- Make sure the direction lever is fully engaged.
- Take care to never overload a torque wrench past its maximum torque capacity.
- Torque wrenches are to be used by hand only. Do not use cheater bars or any other means of increasing leverage.
- Use the appropriate drive size. Select the torque wrench drive that is in the mid-range of the desired torque.
- Never expose any torque wrench to excessive heat, which may change the hardness or microstructure and ruin the tool.
- Never use torque wrenches for prying or as a hammer.
- Send torque wrenches to a qualified lab for calibration at least once a year or every 5,000 cycles, whichever comes first.
- Inspect and discard bent, worn or damaged torque wrenches

TORQUE MULTIPLIERS

- Users and bystanders must wear safety goggles.
- To avoid possible eye injury from flying objects, safety goggles or equivalent protection conforming to ANSI Z87.1 shall be worn and kept clean by the user and all persons in the immediate area where any tool is being used.
- A torque multiplier generates an output torque much greater than the input torque. Do not use a torque multiplier without reading and learning the safety and operating instructions that are provided with each torque multiplier.
- Users must wear hard hats, gloves and steel toed boots.
- Users shall apply a controlled force with a stance adjusted and braced to prevent rapid bodily movement or a fall if sudden release occurs.
- Only use impact sockets with torque multipliers and secure to the output square with a retaining pin & O-ring. Never use hand sockets or any attachments (including adaptors) with torque multipliers.
- Before each use, inspect and replace any torque multiplier output squares showing signs of wear or cracks.
- Before each use, inspect and tighten the torque multiplier holding screws.
- Before each use, inspect and replace any impact sockets or fasteners showing signs of wear or cracks.
- Do not use impact guns with torque multipliers.
- Do not use breaker bars with torque multipliers.



don't get this guy **MAD**.

Distributors deal with demanding customers. You want tough, professional tools those customers will depend on to perform. You want a tool supplier you can depend on too. At Wright Tool, we're constantly striving to perfect performance in our products and services.

We offer the industry's best selection of professional-grade hand tools, including special, custom-made tools. We offer the industry's best delivery and fulfillment records with over 98% shipped in less than two days. And, we offer unmatched technical support—guaranteed.

Demand the best performance for you and your CUSTOMERS

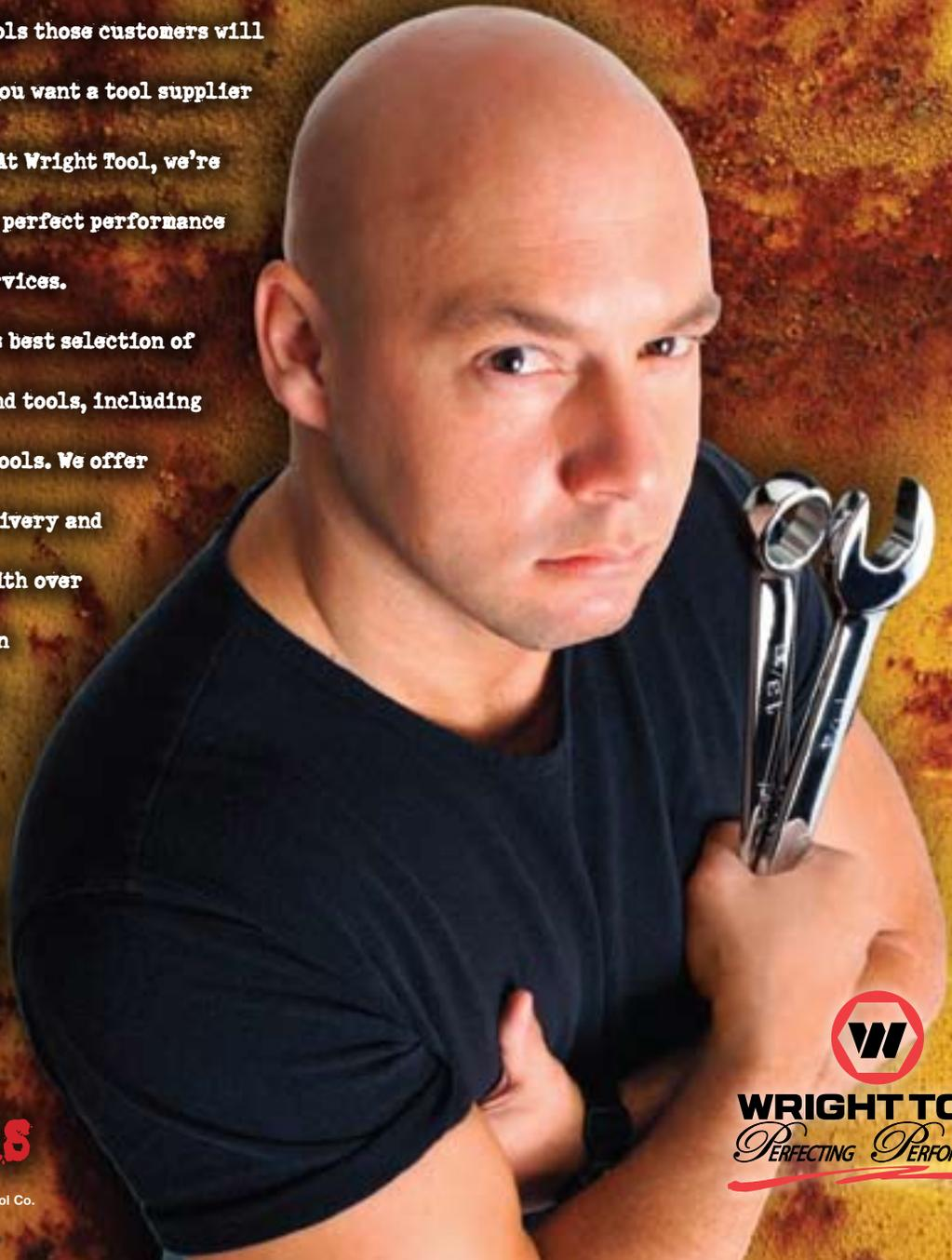

WRIGHT TOOL
PERFECTING PERFORMANCE



Micro-Adjustable “Click Type” Metal Handle Torque Wrenches

- Rugged.
- Accurate, $\pm 4\%$ clockwise, $\pm 6\%$ counterclockwise @ 20% of the scale.
- Easy to operate.
- Durable.
- All parts made from alloy tool steel for long life accuracy. Accuracy meets or exceeds all applicable government specifications.
- Exposed scale.
- Positive lock with spring loaded pull down lock ring. Super rugged knurled metal for industrial use. Pull lock ring down and turn handle to adjust reading. Positive locking device cannot be jarred into unlock position.
- All wrenches meet or exceed ANSI B 107.14M or GGG-S-686, whichever applies.
- Ratchet head models are 24 tooth industrial grade ratchets designed for industrial use.
- Feature a push button socket “quick release” mechanism (except 6448, 8447 and 8448).
- All wrenches feature English scales primary and Newton meter secondary.
- Micrometer “clicker” torque wrenches feature a distinct breaking action when the set torque is reached. the breaking action and clicking noise is greatest at the upper part of the scale.
- All wrenches will be shipped in fitted blow mold plastic storage boxes, except the 8447 and 8448, which will be shipped in a metal box.
- All wrenches include a “Certificate of Calibration.”



4476, 4479, 4477, 4478, 6448



3447, 3477, 3479



2477, 3478





8447



8448



8449



Part No.	Drive Size	Torque Range English	Incr.	Torque Range Metric	Incr. (Nm)	Head Style	Length Inches	Wt. Lbs.
Inch Pound								
2477	1/4"	20-150 in. lb.	1	2.8-16.4	.1	Ratchet	10.15"	.90
3478	3/8"	30-200 in. lb.	1	3.9-22.0	.1	Ratchet	10.15"	.85
3479	3/8"	150-1000 in. lb.	5	19.8-110.2	.6	Ratchet	15.75"	2.5
4476	1/2"	700-1600 in. lb.	10	84.4-175.2	1.2	Ratchet	18"	3.0
4479	1/2"	300-2500 in. lb.	10	39.6-276.8	1.2	Ratchet	18"	3.0
Foot Pound								
3447	3/8"	5-75 ft. lb.	.5	10.2-98.3	.7	Ratchet	15.5"	2.5
3477	3/8"	10-100 ft. lb.	.5	16.9-132.2	.7	Ratchet	15.5"	2.5
4477	1/2"	20-150 ft. lb.	1	34-197	1.5	Ratchet	19"	3.15
4478	1/2"	30-250 ft. lb.	1	47-332	1.5	Ratchet	24.4"	3.15
6448	3/4"	100-600 ft. lb.	5	169-779	7	Ratchet	42"	8.95
8447	1"	200-1000 ft. lb.	5	305-1320	7	Ratchet	70"	40.0
8448	1"	200-1000 ft. lb.	5	305-1320	7	Fixed Head Non-Ratcheting	69"	24.5
8449	1"	300-2000 ft. lb.	10	480-2700	13.5	Fixed Head Non-Ratcheting	108-1/2"	48.75

Contact customer service at (800) 321-2902 for Torque Wrench repair kits.





Dial Type Torque Wrenches

All dial torque wrenches are "State-of-the-Art" torque wrenches. Exclusive torsion beam design provides long life and accuracy.

- Exclusive bi-polar dual scales, English and Metric, permits accurate reading of both scales, with follower needle.
- Equally accurate in both left and right hand direction.
- Torsion drive design.
- Large easy-to-read dial.
- User assured of long life and reliability.
- Accurate, $\pm 2\%$ both ways at 20-100% of full scale.
- Meets and/or exceeds requirements of GGG-W-686 and/or ANSI B107.14M.
- Calibration traceable to National Institute of Standards and Technology (NIST).
- All wrenches shipped in plastic storage box or metal case (except 2,000 ft. lb.), which will be shipped in a cardboard carton.
- Follower Needle.
- All wrenches include a "Certificate of Calibration."



3472



6470

Part No.	Drive	Torque Range English	Grads. English	Torque Range Metric	Grads. Metric	Length	No. of Ext. Handles	Wt. Lbs.
Inch Pound								
2470	1/4"	0-30 in. lb.	.5 in. lb.	0-3.5 Nm	.1 Nm	10"	—	1
2471	1/4"	0-75 in. lb.	1 in. lb.	0-9 Nm	.2 Nm	10"	—	1
3470	3/8"	0-150 in. lb.	2 in. lb.	0-18 Nm	.5 Nm	10"	—	1
3471	3/8"	0-250 in. lb.	5 in. lb.	0-30 Nm	.5 Nm	10"	—	1
3472	3/8"	0-600 in. lb.	10 in. lb.	0-70 Nm	2 Nm	14-7/8"	—	1-3/4
Foot Pound								
3473	3/8"	0-50 ft. lb.	1 ft. lb.	0-70 Nm	2 Nm	14-7/8"	—	1-3/4
+ 4470	1/2"	0-175 ft. lb.	5 ft. lb.	0-240 Nm	5 Nm	21-1/2"	—	2-3/4
+ 4471	1/2"	0-250 ft. lb.	5 ft. lb.	0-350 Nm	10 Nm	21-1/2"	—	2-3/4
6471	3/4"	0-350 ft. lb.	10 ft. lb.	0-480 Nm	10 Nm	27-7/8"	—	5-3/4
6470	3/4"	0-600 ft. lb.	10 ft. lb.	0-800 Nm	20 Nm	46-1/2"	1	9-1/4
8470	1"	0-1000 ft. lb.	20 ft. lb.	0-1400 Nm	25 Nm	74"	1	18-1/2

+ New Rubber Handle





Electric Dial Type Torque Wrenches

- Electric wrenches have an electric light and an audible buzzer. An operator may elect to preset a torque value on the dial face of the torque wrench prior to torquing.
- Electric dial type $\pm 3\%$ accuracy.

Battery Included



6472 - 2 Piece Handle
8471 - 2 Piece Handle



8472



8472

Part No.	Drive	Torque Range English	Grads. English	Torque Range Metric	Grads. Metric	Length	No. of Ext. Handles	Wt. Lbs.
6472	3/4"	0-600 ft. lb.	10 ft. lb.	0-800 Nm	20 Nm	46-1/2"	1	9-1/4
8471	1"	0-1000 ft. lb.	20 ft. lb.	0-1400 Nm	25 Nm	74"	1	18-1/2
8472***	1"	0-2000 ft. lb.	40 ft. lb.	0-2800 Nm	50 Nm	122"	5	44-1/2

***"T" Style, 1" Dr. Female Head for use with torque multiplier. Shipped in cardboard carton.

Note: Must be used as a "T" operated by 2 people.

Torque Angle Method

The torque wrench has been the standard for tightening bolts and nuts that clamp parts together for many years. Torque is the force used to turn a fastener nut or bolt against friction. Friction occurs between the nut or bolt threads, fastener head and component surface. With the many variations in squareness and stiffness of the mating parts, clamping forces can vary significantly. The torque method also relies heavily on the consistency of the operator.

The Torque Angle Method specifies an initial torque in conjunction with a specific angular measurement. The initial torque mates the components. The fastener is then rotated a specific number of degrees. If cross-threading or high-friction occur, the fastener won't rotate the proper number of degrees. If the fastener strips or there is low friction, it will rotate beyond the specified number of degrees.

The Torque Angle Method takes into consideration the many variables such as flatness, squareness of bolt heads, and surface finish that torque alone doesn't account for. The Torque Angle Method is commonly used in Europe, and specified by Mercedes Benz for over 15 years on all critical fasteners.



Part No.	Description
9L28100	1/2" drive





Electronic Torque Wrenches

Features

The E-WRENCH digitally displays fastener torque specification settings, torque readings and peak hold measurements.

- **Display** – The wrench features a custom LCD with keypad selectable torque units conversion readout in ft-lb, in-lb kg-cm and Nm. 10 Bar-graph for Preset value.
- **Setting** – Torque specification for fastener. The set value is adjustable between 10% and 100% of full scale by pushing the up or down keys. The scrolling display adjustment rolls-over at both ends for convenient and quick setting.
- **Tracking** – While wrenching, the display switches to read the actual torque applied with a 0.2 second update rate.
- **Audible and LED's** – When the applied torque equals the set torque value the wrench outputs a 1/2 second audible tone and the Green LED's and Red LED's lit until torque is released. Yellow LED's will light at -10% of Preset-torque.
- **Peak Hold** – When torque is released the display holds and flashes the peak torque reading for 10 seconds or until torque is re-applied.



- **Overload** – If the wrench is used beyond 100% full scale the audible tone will pulse rapidly to warn the operator to stop. At 125% of full scale the display will lock up and read “- - - -”.
- **Zero** – Automatic self-check and re-zero at power-on and any time the ON/ZERO key is pushed. (This is not a calibration check).
- **Setup Memory** – At power-on the wrench returns to the last unit and torque setting.
- **Battery** – The Wright Tool wrench uses three standard replaceable “CR123” Lithium cells for better than 80 hours continuous operation. A display indicator shows battery condition. A flashing “bAtt” display means the wrench is no longer accurate and the battery must be replaced.
- **Auto Power Off** – Automatic shut-off after sitting idle for 2 minutes.

US and Foreign Patents Pending

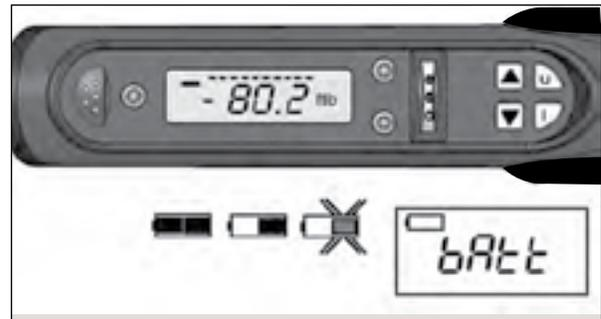
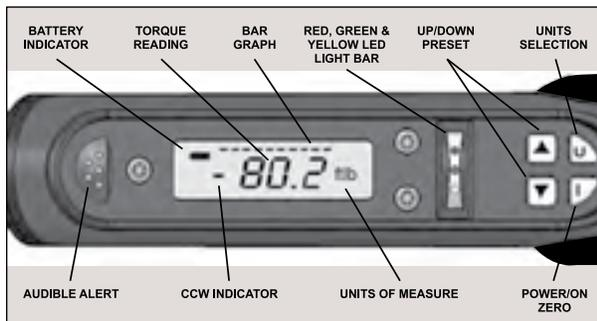

Operator Instruction

Unscrew endcap on back of handle and install two “CR123” 3 Volts Lithium cells, positive end into the handle first. (refer to page ?)

1. Push “ON/ZERO” key – the wrench will self-test and display the last fastener torque spec. setting.
2. Push “UNITS” key – to select “Nm,” “ft lb,” “in lb.” or “kgcm”
3. Push and hold “Δ” (UP) or “∇” (DOWN) keys to set the fastener torque spec. (Display will roll-over at each end).
4. Apply torque slowly, grasping the center of the handle. **DO NOT APPLY LOAD TO THE END OF THE HANDLE.** The display will **TRACK** the applied torque. Stop and release torque when the **audible alert** is heard and the **Green and Red LED's lit, Yellow LED's will lit at 90% of Preset.**
5. On release, note the **PEAK** (highest) torque applied* it will be displayed, flashing for 10 seconds or until torque is re-applied.

*The **PEAK** torque reading will tell you if excess torque has been applied. This feature can be used to improve your wrenching technique for best accuracy. E-Wrench will automatically shut off after two minutes sitting idle to conserve battery power. The ON/ZERO key can be held down for 5 seconds to turn the wrench off.

CALIBRATION

Contact CDI Torque Products for calibration services.
19220 San Jose Ave, CA 91748. Phone: (626) 965-0668.

IMPORTANT!

Calibration by the user is recorded in the wrench memory and voids factory certification.

Equipment Required: Precision test bars and certified calibration weights, or another torque source, accurate to 1/2% of reading.

MAINTENANCE / SERVICE

Clean torque wrench by wiping with a damp cloth. Do NOT use solvents, thinners or engine cleaners. Do NOT immerse in anything. Service, repair and calibration are to be done by CDI Torque Products Service Centers only.

CERTIFICATION

This torque wrench, as calibrated at the factory, is certified to meet the accuracy specified in International Standard ISO 6789 and was calibrated on a torque standard traceable to the National Institute of Standards Technology (N.I.S.T.).

NOTE: If the display shows “Err0” at power on, the wrench is damaged and must be returned for repair.

BATTERY REPLACEMENT

Replace with two “CR123” Lithium cells only. (Available anywhere)





USE OF ADAPTORS, EXTENSIONS AND UNIVERSALS

Anytime an adaptor, extension or universal is used with a torque wrench in such a way that the fastener distance is different than the torque wrench square drive distance, an adjustment to the set torque is required to get proper fastener torque.

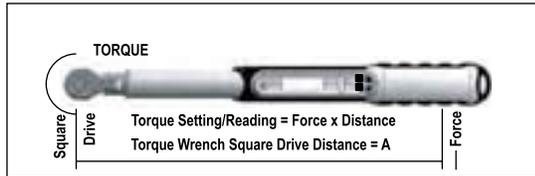

Fastener torque equals torque wrench square drive torque.
Wrench setting is equal to desired fastener torque.

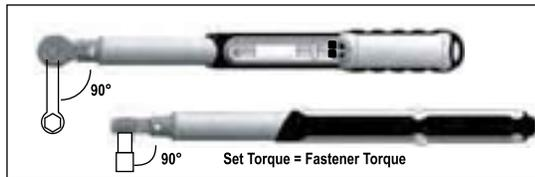

Fastener torque equals torque wrench square drive torque.
Wrench setting is equal to desired fastener torque.

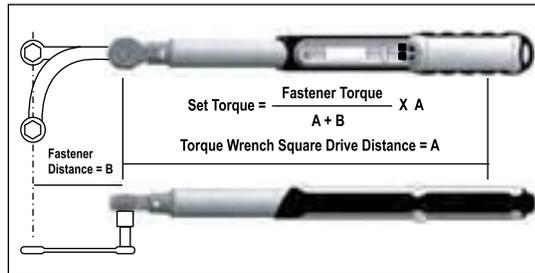

Fastener torque is greater than torque wrench square drive torque.
Calculated setting will be lower than desired fastener torque.

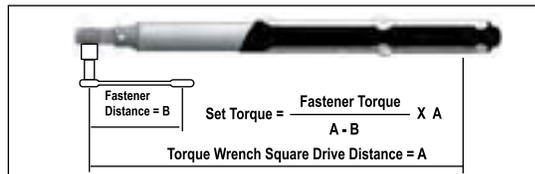

Fastener torque is less than torque wrench square drive torque.
Calculated setting will be higher than desired fastener torque.

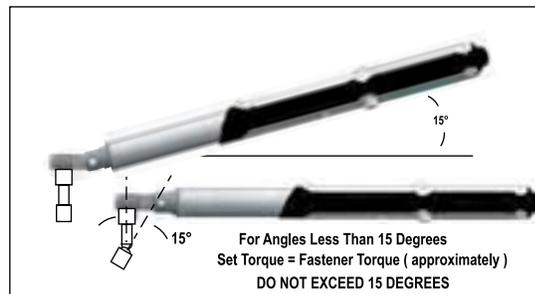

When using wobble extension or a universal, do not exceed more than 15 degrees of offset from perpendicular drive. Do not use a long extension with the flex-drive at full flex.

SPECIFICATIONS

Display – 4-digit LCD, Low Battery Indicator.

Setting – display with no torque applied

Tracking – real time with torque applied

Peak – 10 sec. flashing at torque release

Display Capacity 8,000 Counts CW/CCW torque from 10% to 125% of full scale.

Accuracy (72 °F)	CW	CCW
	+/-2%	+/-3% of reading, 20% to 100% of full scale
	+/-4%	+/-6% of reading, 10% to 19% of full scale

Torque Setting Resolution

1.0 ft-lb, 1.0 Nm, 1 in-lb.

Sealed Key Pad

ON/ZERO power on - auto self check - zero

UP (+) increments torque setting

DOWN (-) decrements torque setting

UNITS selects **Nm, ft-lb, in-lb** or **kg-cm**, display

Operating Temperature 40 to 110°F (5 to 42°C)

Storage Temperature -1 to 122°F (-20 to 50°C)

Humidity – up to 90% non-condensing

Dimensions:	length	weight	Drive
	240 in-lb	15 in 2.0 lbs	1/4"
	100 ft-lb	17 in 2.2 lbs.	3/8"
	250 ft-lb	27 in 3.5 lbs	1/2"

Battery – two "CR123" Lithium cells, over 80 hours continuous operation.

Auto Shut-off – after 2 minutes idle with no torque applied.

Part No.	Drive	ft-lb	in-lb	Nm	kgcm
2473	1/4"	2.0 - 20.0	24 - 240	2.71 - 27.10	27.6 - 276
3474	3/8"	5.0 - 100.0	120 - 1200	13.5 - 135.6	138 - 1382
4474	1/2"	25 - 250	300 - 3000	33.8 - 338	345 - 3456





Electronic Torque Wrenches – Computorq II

Features

- **Largest Storage Capacity Available** – Up to 4000 torque values can be stored in memory. An audible tone signals when memory is full.
- **Downloading Capacity** – Computorq II is equipped to download individual torque values or store values in memory which can be directly downloaded to a printer/computer/data logger via RS232.
- **Easy Set-Up** – Target torque values (high and low percentages, +/- tolerances and torque engineering units) are easily programmed through the keypad and shown on the LCD.
- **Baud Rate** – The Baud rate for downloading to a printer/computer/data logger is selectable. The factory set rate is 1200. Options are 300, 600, 1200, 2400, 4800 or 9600.
- **Audio Signal** – An audio signal is emitted when the minimum acceptable preset torque value is reached or the upper torque limit is exceeded.
- **Visual Indicators** – Bright green and red LEDs are standard indicators of high and low preset torque limits.
- **Overload-Protection** – The red LED flashes, the audio buzzer sounds and “OVER” is displayed on the LED when the torque range of the wrench is exceeded.
- **Engineering Units** – All seven basic engineering torque units are available on most Computorq II models (Ft. Lb., in. Lb., in. Oz., Nm, dNM, Mkg. or cmkg) and are easily selected through the keypad.
- **Displayed Torque Measurements** – Torque measurements captured on the display remain until they are erased, sent to the wrench’s memory, or downloaded to an external device.
- **Recall of Torque Measurements** – Up to 999 torque measurements can be reviewed by the operator, in sequence of operation, by pressing the recall button.
- **Bar Graph** – A bar graph is displayed on the LCD showing the relative position of applied torque to the preset torque range.



Part No.	Drive	Range	Increments	Length Inches	Wt. Lbs.
6473	3/4"	60-600 ft. lb. 81-813 Nm 8.3-83 mkg	.1 ft. lb. .1 Nm .01 mkg	46.5"	9.5
8473	1"	100-1000 ft. lb. 135-1355 Nm 14-138 mkg	.1 ft. lb. .1 Nm .1 mkg	74.0"	19.0





Torque Screwdrivers – Blue Metallic Finish

- 3 models available.
- Positive-locking pull-down adjustment knob.
- Trilobular comfort grip.
- Universal 1/4" hex bit holder with strong Rare Earth magnet.
- Cam-over torque-limiting clutch.
- Easy-to-read widow scale.
- Lightweight, ease-of-use.
- Automatic lock in counterclockwise direction.
- Accuracy $\pm 6\%$ clockwise direction, from 20 in. ozs., 100% of full scale.
- Individually serialized with matching certificate of calibration traceable to N.I.S.



Part No.	Square Drive Size	Torque Range in. oz./in. lbs.	Increments	Shipping Weight
2462	1/4" Female Hex	20-100 in. oz.	1 in. oz.	1 lb.
2463	1/4" Female Hex	3-15 in. lbs.	.2 in. lbs.	1 lb.
2464	1/4" Female Hex	5-40 in. lbs.	.5 in. lbs.	1 lb.

Note: See pages 115-117 for hex bits.

Wright Tool Torque Wrench Warranty

All Wright Tool torque wrenches are warranted against defects in materials or workmanship for a period of one year from the date of purchase. One of our authorized repair facilities, at their discretion, will repair or replace any defective Wright torque wrench returned to their place of business, postage or freight prepaid. All torque wrenches must be accompanied with a dated copy of the sales receipt or purchase order.

The foregoing obligation is Wright Tool's sole liability and the purchaser's sole remedy under this warranty. There are no other warranties expressed or implied, including those of market ability or fitness for purpose. Under no circumstances shall Wright Tool be liable for any special, incidental or consequential damages.

This warranty does not apply if the torque wrench has been altered,

damaged, abused or improperly maintained. This warranty gives you specific legal rights and you may have other rights which vary from state to state.

NOTE:

Please contact Wright Tool Customer Service at 1-800-321-2902 or FAX 1-800-543-2095 for shipping instructions on the return of all torque wrenches for warranty, repairs or other services.

All warranty considerations will be returned to the customer freight prepaid. All non-warranty repairs or calibrations will be returned to the customer with all applicable charges and freight collect.





Why use a torque multiplier?

A torque multiplier is used to reduce the effort needed to tighten or loosen a fastener. By using a torque multiplier, thousands of foot pounds of torque can be accurately applied with a standard 250 foot pound torque wrench.

Wright Tool offers a complete line torque multipliers. These tools offer a simple, inexpensive solution to common bolting challenges. Our multipliers ranging in output torque from 750 ft-lbs to 8,000 ft-lbs typically require a maximum input torque of only 200 ft-lbs or less. All of our tools can be operated with any standard torque wrench and will "multiply" the torque to achieve significantly higher torque outputs. We offer both reaction bar multipliers, which will typically react against a flange, as well as reaction plate multipliers designed to react against an adjacent bolt. Other features of these tools include:

Safe, Light – Our unique one-piece construction requires use of just one tool. A single tool is easier to handle and safer to operate vs. stacking a number of multipliers. Single piece construction also makes the package smaller and lighter.

Accurate – Use of needle roller bearings produces more efficient and repeatable output torque (all except 9S290P, 9S291 and 9S292). All models except the 9S292 have a torque accuracy of +/-5%.

Fast – Our input torque holding ratchet assists in holding our multiplier in place while applying torque to fastener, making fastening safer and faster. This feature is standard on all models except 9S290P, 9S291, 9S292 and 9S391.

Easy To Use – Our low input torque requirement makes our tools easy to use. Most tools require less than 200 ft-lb input to obtain the multipliers maximum output torque.

Service & Support – Excellent application assistance and product support is always available.

Simple – A torque conversion chart is attached directly on top of each tool to show the operator the torque input required for a given torque output.

Precise – An angle of turn protractor included on our 391, 9S392 and 9S393 models allows the user to use torque/angle of turn method to tighten fasteners more accurately.

Durable – All of our multipliers come with a replaceable output square drive which protects multiplier's powertrain from accidental torque overload by shearing at 3 to 10% over multiplier's rated capacity.

Torque Multipliers

Features of the 9S290P, 9S291, 9S391 & 9S292

- Compact
- Low Cost
- Light Weight
- Rugged Construction



9S290P



9S291



9S391



9S292





9S392B, 9S393A

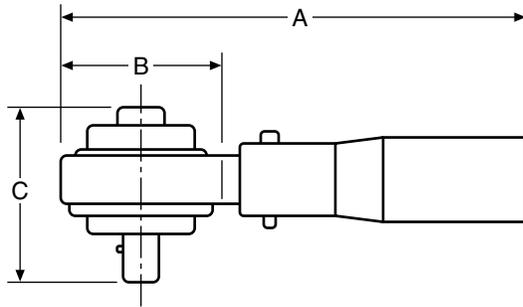

Features of the 9S392B & 9S393A

- Low Input Torque
- Needle Bearings for High Efficiency
- Input Torque Holding Ratchet – Holds Multiplier in place during torquing.
- $\pm 5\%$ Accuracy – Closer accuracy and torque certificates available.
- 1/2" Square Female Input
- Shearable Output Squares – Drive Shear at 3-10% overload to protect tool. A replacement Drive included, is easily installed.
- Angle or Turn Protractor



Part No.	Description	Input Drive	Input Capacity	Output Drive	Output Capacity	Torque Ratio	A Length	B Head Dia.	C Height	Wt. Lbs.
9S290P*	Torque Multiplier (in red plastic box w/handle)	1/2" Sq Female	227 Ft.-Lbs.	3/4" Sq. Male	750 Ft. Lbs.	3.3:1	8-3/4"	2-13/16"	3-1/4"	4
9S291	Torque Multiplier	1/2" Sq. Female	303 Ft.-Lbs.	3/4" Sq. Male	1,000 Ft. Lbs.	3.3:1	17-1/8"	2-13/16"	3-5/16"	5.5
9S391	Torque Multiplier	1/2" Sq. Female	200 Ft.-Lbs.	3/4" Sq. Male	1,200 Ft. Lbs.	6:1	19.6"	3.94"	4"	9.1
9S292	Torque Multiplier	3/4" Sq. Female	571 Ft.-Lbs.	1" Sq. Male	2,000 Ft. Lbs.	3.5:1	19-1/2"	4-1/2"	3-13/16"	12
9S392B**	Torque Multiplier (in red plastic box w/handle)	1/2" Sq. Female	162 Ft.-Lbs.	1" Sq. Male	2,200 Ft. Lbs.	13.6:1	19-5/8"	4-1/16"	6-1/2"	15.2
9S393A**	Torque Multiplier (in red plastic box w/handle)	1/2" Sq. Female	173 Ft.-Lbs.	1" Sq. Male	3,200 Ft. Lbs.	18.5:1	19-5/8"	4-1/16"	6-1/2"	18.3

*New Heavy Duty Compact Design

**Anti-Backlash





Replacement Output Squares for Torque Multipliers

Part No. Description

9S391RS	Replacement Square for Multiplier 9S391
9S392RS	1" Replacement Square for Multiplier 9S392B & 9S492
9S393RS	1" Replacement Square for Multiplier 9S393A
9S394RS	1-1/2" Replacement Square for Multiplier 9S394
9S395RS	1-1/2" Replacement Square for Multiplier 9S395

Square shears at 3% -10% overload to protect tool
 Guarantee does not apply



Torque Multipliers – Plate Reaction Style



9S492

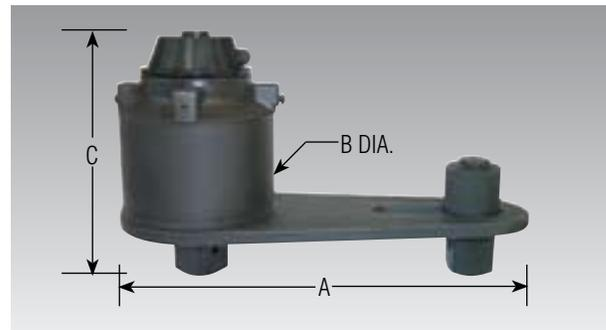

9S394

Part No.	Input	Output Capacity lb-ft (N•m)	Input Capacity lb-ft (N•m)	Gear Ratio	Torque Ratio	Output Square Size (in)	Overall Dim. Inches (mm)	Net Weight lbs (kg)
9S492	1/2" sq.	2,200 (2,983)	162 (220)	15:1	13.6:1	1	A=14.0 (356) B=4.88 (124) C=5.50 (140)	17.2 (7.8)
9S394	1/2" sq.	5,000 (6,779)	189 (256)	29.25:1	26.5:1	1 1/2	A=14.9 (378) B=5.62 (143) C=8.75 (222)	34.0 (15.4)
9S395	1/2" sq.	8,000 (10,846)	154 (209)	60:1	52.0:1	1 1/2	A=15.2 (387) B=5.81 (148) C=10.75 (273)	50.3 (22.8)





Air Motor for Torque Multipliers

Part No.	Drive Size	Description
9S3900A	Torque	Air Motor for Torque Multiplier

Not for use on: 9S290P, 9S291, 9S391 and 9S292
 Output Drive: 1/2" sq.
 Maximum output torque: 200 ft. lbs.
 Maximum running air pressure: 60 PSI
 Free speed (reversible): 70 RPM
 Overall length: 16.25 in.



Reaction Foot Torque Multipliers

Part No.	Output Capacity lbf-ft [Nm] Continuous/ Peak	Torque Ratio	Input Square Size	Output Square Size	Accuracy	Overload Protection	Anti-Backlash	Head Dia. in. (mm)	Height in. (mm) ³	Wt. lbs. ₂ (kg) ²
9STM12*	735 (1000)/ 885 (1200)	3.4:1	1/2"	3/4"	±5%	Yes	No	3.4 (86)	7.3 (186)	7.5 (3.4)
9STM30	1845 (2500)/ 2200 (3000)	10.5:1	1/2"	1"	±5%	Yes	Yes	3.4 (86)	8.7 (221)	9.9 (4.5)
9STM70	4425 (6000)/ 5175 (7000)	33:1	1/2"	1-1/2"	±5%	Yes	Yes	4.5 (114)	10.6 (270)	22 (10)

1. Powerlock is standard on all tools unless denoted by*
2. If overload protection is specified increase weight by 2.21 lbs. (1 kg)
3. If overload protection is specified increase height by 1.2" (30mm)
4. All tools come with carrying case

Specifications subject to change without notice.



Part No.	Description
9SSFT	Straight Foot Tool for 9STM 12 and 9STM 30

9STM 70 available by special order. Contact Customer Service.





Torque Tester

The 9S7475 is a microprocessor based, bending beam type torque tester used for checking dial type or impulse type torque wrenches. Automatic conversion to Lb.-Ft., Lb.-In., Oz.-In., N-m, mN-m or Kgf-M torque units.

- Three Modes of Operation...Read Torque, Continuously/Detect and Hold "Click."
- Click Mode allows rapid calibration of click type torque wrenches without additional fixtures
- Accuracy...±0.5% FS (10 to 100% FS)
- 16 Character Alphanumeric Display
- Six Scales with Automatic Unit Conversion...English (lb-ft, lb-in, oz. in) Metric (N Bwm, mN Bwm, kgf-m)

- Clockwise or Counterclockwise Readings
- Battery or AC Operation
- Automatic Power-Down to Conserve Battery
- Low Battery Indication
- Serial Printer Interface (RS232)
- Overrange Indication (110% of FS)
- Compact...7.25 in. (184mm) H x 4 in. (102mm) W x 10.5 in. (267mm) D
- Light Weight...13.5 lbs. (6.1 kg)



9S7475

Description

	Lb-Ft	Lb-In	Oz-In	N-m	mN-m	KGF-M
Maximum Torque	250	3,000	48,000*	339**	338,955***	34.6****
Approximate Readout Increments	.3	4	53	.4	373	.04

Drive Size – 1/2" Female Sq. w/1/2"M x 3/8"F Adapter

Weight – 13.5 Lbs. (approx.)

Envelope Size – 7.25"H x 4"W x 10.5"D

*Maximum Oz-In value displayed is approximately 32,768

**Maximum N-m value displayed is approximately 327.6

***Maximum mN-m value displayed is approximately 32,768

****Maximum KGF-M value displayed is approximately 32.76



SCREWDRIVERS & NUTDRIVERS



Wright screwdrivers can be ordered individually or in

sets. Styles include Phillips, cabinet tip, round shank

and square shank (all with or without cushion grips). We

also offer handy 4-in-1 screwdrivers, as well as hollow-

shaft nut drivers in standard and metric styles.



SCREWDRIVERS & NUTDRIVERS.





W A R N I N G !

SCREWDRIVERS AND NUTDRIVERS

- Users and bystanders must wear safety goggles.
- To avoid possible eye injury from flying objects, safety goggles or equivalent protection conforming to ANSI Z87.1 shall be worn and kept clean by the user and all persons in the immediate area where any tool is being used.
- Comfort or plastic grips on handles are not intended to give any degree of protection against electric shock and screwdrivers and nutdrivers shall not be used on or near live electric circuits.
- Users shall apply a controlled force with a stance adjusted and braced to prevent rapid bodily movement or a fall if sudden release occurs. Minimize pressure. Screws are driven by torque (turning power), not pressure.
- Match the type of screwdriver to the head of the screw and select the appropriate size screwdriver to do the job.
- Never sharpen or alter a screwdriver to change the fit.
- Use the correct size nutdriver to fit the fastener. Do not use inch nutdrivers on metric fasteners or metric nutdrivers on inch fasteners because the fit is not good enough.
- Never use a screwdriver or nutdriver for prying, punching, chiseling, scoring or scraping.
- Never hammer on screwdrivers or nutdrivers and never use a screwdriver or a nutdriver as a hammer.
- Never use cheater bars to increase handle leverage.
- Never expose any screwdriver or nutdriver to excessive heat, which may change the hardness or microstructure and ruin the tool.
- Never use pliers on the handle of a screwdriver or nutdriver to get extra turning power. A wrench can be used on the square shank or bolster of screwdrivers designed for that purpose.
- Keep handles clean for a secure grip.
- Inspect and discard bent, worn, cracked, or damaged screwdrivers or nutdrivers. Do not grind or attempt to repair screwdrivers.





5 Pieces – Screwdriver Set Set No. 9475

Part No.	Description	Tip Size	Blade Length
9124	Round Shank Screwdriver	1/4"	6"
9125	Round Shank Screwdriver	5/16"	6"
9116	Cabinet Tip Screwdriver	3/16"	6"
9105	Phillips Screwdriver	#2	4"
9134	Square Shank Screwdriver	5/16"	6"
A711-Pouch	Pouch		



10 Pieces – Screwdriver Set Set No. 9476

Part No.	Description	Tip Size	Blade Length
9123	Round Shank Screwdriver	1/4"	4"
9124	Round Shank Screwdriver	1/4"	6"
9115	Cabinet Tip Screwdriver	3/16"	4"
9116	Cabinet Tip Screwdriver	3/16"	6"
9122	Round Shank Screwdriver	1/4"	1-1/2"
9135	Square Shank Std. Tip	3/8"	8"
9106	Phillips Screwdriver	#3	6"
9104	Phillips Screwdriver	#1	3"
9105	Phillips Screwdriver	#2	4"
9101	Phillips Screwdriver	#2	1-1/2"
A714-Pouch	Pouch		



6 Pieces – Screwdriver Set Set No. 9477

Part No.	Description	Tip Size	Blade Length
9105	Phillips Screwdriver	#2	4"
9122	Round Shank Screwdriver	1/4"	1-1/2"
9125	Round Shank Screwdriver	5/16"	6"
9123	Round Shank Screwdriver	1/4"	4"
9124	Round Shank Screwdriver	1/4"	6"
9116	Cabinet Tip Screwdriver	3/16"	6"
A711-Pouch	Pouch		





**6 Pieces – Screwdriver Set
 Set No. 9462 - 6 Pieces**

Part No.	Description	Tip Size	Blade Length
9101	Phillips Screwdriver	#2	1-1/2"
9103	Phillips Screwdriver	#0	3"
9104	Phillips Screwdriver	#1	3"
9105	Phillips Screwdriver	#2	4"
9106	Phillips Screwdriver	#3	6"
9109	Phillips Screwdriver	#4	8"
A711-Pouch	Pouch		



**8 Pieces – Screwdriver Set
 Set No. 9463 - 8 Pieces**

Part No.	Description	Tip Size	Blade Length
9104	Phillips Screwdriver	#1	3"
9105	Phillips Screwdriver	#2	4"
9106	Phillips Screwdriver	#3	6"
9114	Cabinet Tip Screwdriver	3/16"	3"
9115	Cabinet Tip Screwdriver	3/16"	4"
9116	Cabinet Tip Screwdriver	3/16"	6"
9123	Round Shank Screwdriver	1/4"	4"
9125	Round Shank Screwdriver	5/16"	6"
A711-Pouch	Pouch		



**6 Pieces – Screwdriver Set
 Set No. 9464 - 6 Pieces**

Part No.	Description	Tip Size	Blade Length
9115	Cabinet Tip Screwdriver	3/16"	4"
9122	Round Shank Screwdriver	1/4"	1-1/2"
9123	Round Shank Screwdriver	1/4"	4"
9125	Round Shank Screwdriver	5/16"	6"
9126	Round Shank Screwdriver	3/8"	8"
9127	Round Shank Screwdriver	3/8"	10"
A714-Pouch	Pouch		





9105

Phillips Screwdrivers

Large Ergonomic 3-flute Handle

Part No.	Tip Size	Overall Length	Blade Length	Handle Length
9101	#2	3-7/16"	1-1/2"	1-15/16"
9103	#0	6"	3"	3"
9104	#1	7"	3"	4"
9105	#2	8-1/4"	4"	4-1/4"
9106	#3	10-7/8"	6"	4-7/8"
9107	#1	12"	8"	4"
9108	#2	12-1/4"	8"	4-1/4"
9109	#4	13-1/2"	8"	5"



9125

Round Shank Screwdrivers

Large Ergonomic 3-flute Handle

Part No.	Tip Size	Overall Length	Blade Length	Handle Length
9122	1/4"	3-7/16"	1-1/2"	1-5/16"
9123	1/4"	6"	4"	3"
9124	1/4"	10-1/4"	6"	4-1/4"
9125	5/16"	10-7/8"	6"	4-7/8"
9126	3/8"	13-1/2"	8"	5-1/2"
9127	3/8"	15-1/2"	10"	5-1/2"
9128	3/8"	17-1/2"	12"	5-1/2"



9114

Cabinet Tip Screwdrivers

Large Ergonomic 3-flute Handle

Part No.	Tip Size	Overall Length	Blade Length	Handle Length
9112	1/8"	6"	3"	3"
9113	1/8"	8"	5"	3"
9114	3/16"	7"	3"	4"
9115	3/16"	8"	4"	4"
9116	3/16"	10"	6"	4"
9117	3/16"	12"	8"	4"
9118	1/4"	14-1/4"	10"	4-1/4"



9134

Square Shank Screwdrivers

Large Ergonomic 3-flute Handle

Part No.	Tip Size	Overall Length	Blade Length	Handle Length
9132	1/4"	8-1/4"	4"	4-1/4"
9133	1/4"	10-1/4"	6"	4-1/4"
9134	5/16"	10-7/8"	6"	4-7/8"
9135	3/8"	13-1/2"	8"	5-1/2"
9136	3/8"	15-1/2"	10"	5-1/2"
9137	3/8"	17-1/2"	12"	5-1/2"





Cushion Grip Phillips Screwdrivers

Large Cushion Grip Handle

Part No.	Tip Size	Overall Length	Blade Length	Handle Length
9141	#2	3-7/16"	Stubby	1-15/16"
9143	#1	7"	3"	4"
9144	#2	8-1/4"	4"	4-1/4"
9145	#3	10-7/8"	6"	4-7/8"
9146	#4	13-1/2"	8"	5-1/2"



9144

Cushion Grip Round Shank Screwdrivers

Large Cushion Grip Handle

Part No.	Tip Size	Overall Length	Blade Length	Handle Length
9151	1/4"	3-7/16"	1-1/2"	1-15/16"
9152	1/4"	8-1/4"	4"	4-1/4"
9153	1/4"	10-1/4"	6"	4-1/4"
9154	5/16"	10-7/8"	6"	4-7/8"
9155	3/8"	13-1/2"	8"	5-1/2"
9156	3/8"	15-1/2"	10"	5-1/2"
9157	3/8"	17-1/2"	12"	5-1/2"



9154

Cushion Grip Cabinet Tip Screwdrivers

Large Cushion Grip Handle

Part No.	Tip Size	Overall Length	Blade Length	Handle Length
9162	3/16"	7"	3"	4"
9163	3/16"	8"	4"	4"
9164	3/16"	10"	6"	4"
9165	3/16"	12"	8"	4"
9166	1/4"	14-1/4"	10"	4-1/4"



9164

Cushion Grip Square Shank Screwdrivers

Large Cushion Grip Handle

Part No.	Tip Size	Overall Length	Blade Length	Handle Length
9172	1/4"	8-1/4"	4"	4-1/4"
9173	1/4"	10-1/4"	6"	4-1/4"
9174	5/16"	10-7/8"	6"	4-7/8"
9175	3/8"	13-1/2"	8"	5-1/2"
9176	3/8"	15-1/2"	10"	5-1/2"
9177	3/8"	17-1/2"	12"	5-1/2"



9116





9180



9182



9181



9183, 9184, 9185



9186

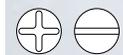

9187

Four-Way Screwdriver

Large Ergonomic 3-flute Handle

Part No.	Tip Size	Overall Length	Blade Length	Handle Length
9180*	3/16" x 5/16" #1 P x #2 P	7-1/2"	3-1/2"	4"
9182**	#0, #1 #2, #3	7-1/2"	3-1/2"	4"

NOTE: Standard pack of 12 in cardboard container/display.

*Flip style has 2 size slotted and 2 size Phillips tips.

**Flip style has 4 Roberts type square recess size.

2-in-1 Pocket Screwdriver

Part No.	Tip Size	Overall Length	Blade Length	Handle Length
9181	3/16" x #1 P	4-13/16"	2-5/8"	2-3/16"

Offset Screwdriver

Part No.	Description	Overall Length
9183	1/4"	4-7/16"
9184	5/16"	4-1/2"
9185	3/8"	5-7/8"
9186	#1 x #2	4-3/4"
9187	#2 x 1/4" slot	4-1/2"





**7 Pieces – Nut Driver Set
Set No. 9210**

Part No.	Description	Part No.	Description
9220	3/16"	9224	5/16"
9221	7/32"	9225	11/32"
9222	1/4"	9226	3/8"
9223	9/32"	A724-Pouch	Pouch



**7 Pieces – Nut Driver Set
Set No. 9212**

Part No.	Description	Part No.	Description
9220	3/16"	9226	3/8"
9222	1/4"	9227	7/16"
9224	5/16"	9228	1/2"
9225	11/32"	A724-Pouch	Pouch

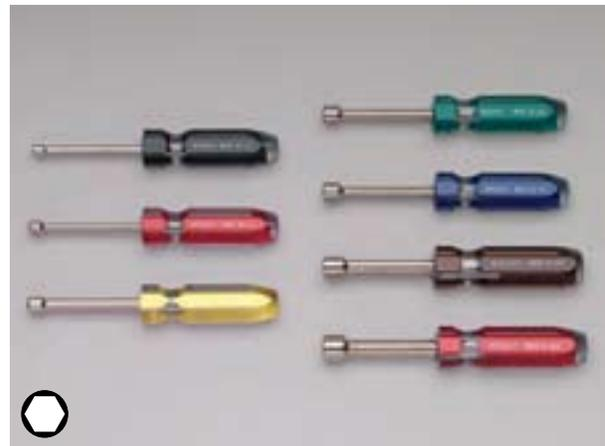

**11 Pieces – Nut Driver Set
Set No. 9214**

Part No.	Description	Part No.	Description
9220	3/16"	9226	3/8"
9221	7/32"	9227	7/16"
9222	1/4"	9228	1/2"
9223	9/32"	9229	9/16"
9224	5/16"	9230	5/8"
9225	11/32"	A711-Pouch	Pouch

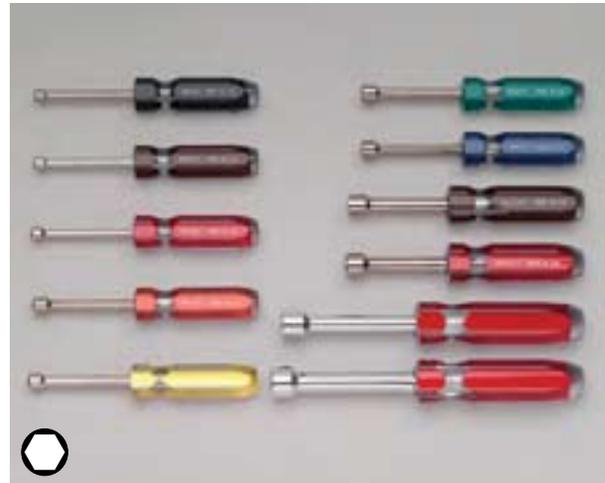

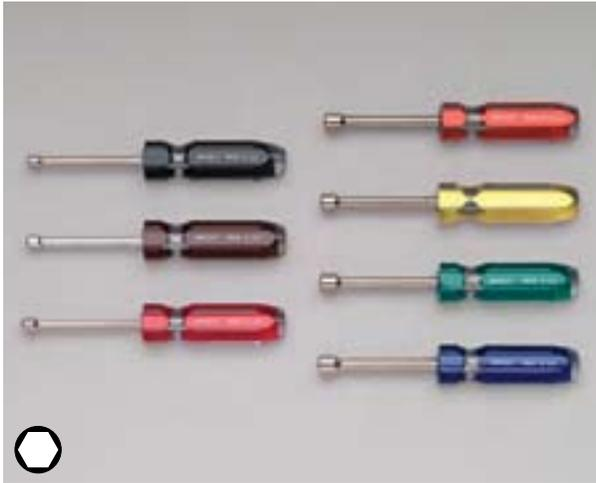

7 Pieces – Metric Nut Driver Set Set No. 9216

Part No.	Description	Part No.	Description
9238	5mm	9242	8mm
9239	5.5mm	9243	9mm
9240	6mm	9244	10mm
9241	7mm	A724-Pouch	Pouch



10 Pieces – Metric Nut Driver Set Set No. 9218

Part No.	Description	Part No.	Description
9236	4mm	9242	8mm
9237	4.5mm	9243	9mm
9238	5mm	9244	10mm
9239	5.5mm	9245	11mm
9240	6mm	A711-Pouch	Pouch
9241	7mm		





Nut Drivers

Part No.	Description	Part No.	Description
9220	3/16"	9226	3/8"
9221	7/32"	9227	7/16"
9222	1/4"	9228	1/2"
9223	9/32"	9229	9/16"
9224	5/16"	9230	5/8"
9225	11/32"		



Metric Nut Drivers

Part No.	Description	Part No.	Description
9236	4mm	9241	7mm
9237	4.5mm	9242	8mm
9238	5mm	9243	9mm
9239	5.5mm	9244	10mm
9240	6mm	9245	11mm



HEX KEYS



A wide assortment of new hex key sets are available from Wright Tool. Choose from 5-piece sets up to 18-piece sets, some carded, some in pouches. Styles include L-key sets (short arm, long arm, combination and metric), fold-up sets (carded and metric), and T-handle sets (loop and metric, with or without vinyl grips). Hex bit sockets can be found with the 1/4", 3/8", 1/2" and 3/4" drive sockets.



HEX KEYS.





W A R N I N G !

HEX KEYS

- Users and bystanders must wear safety goggles.
- To avoid possible eye injury from flying objects, safety goggles or equivalent protection conforming to ANSI Z87.1 shall be worn and kept clean by the user and all persons in the immediate area where any tool is being used.
- Comfort or plastic grips on handles are not intended to give any degree of protection against electric shock and shall not be used on or near live electric circuits.
- Users shall apply a controlled force with a stance adjusted and braced to prevent rapid bodily movement or a fall if sudden release occurs.
- Never hammer on a hex key.
- Never use a pipe or cheater bar on the handle or key end.
- Do not repair hex key wrenches.
- Inspect and discard bent, deformed or cracked hex key tools.



Hex Keys

safety



7 Pieces – Fractional L-Key Set, Short Arm in Pouch
Set No. 9E69207



Part No.	Description
9E69207	Sizes: 5/64", 3/32", 1/8", 5/32", 3/16", 7/32", 1/4"



11 Pieces – Fractional L-Key Set, Short Arm in Pouch
Set No. 9E69211



Part No.	Description
9E69211	Sizes: .050, 1/16", 5/64", 3/32", 1/8", 5/32", 3/16", 7/32", 1/4", 5/16", 3/8"



9 Pieces – Fractional L-Key Set, Long Arm in Pouch
Set No. 9E69209



Part No.	Description
9E69209	Sizes: 5/64", 3/32", 1/8", 5/32", 3/16", 7/32", 1/4", 5/16", 3/8"



Hex Keys





11 Pieces – Fractional L-Key Set, Long Arm in Pouch
Set No. 9E10311



Part No.	Description
9E10311	Sizes: 5/64", 3/32", 7/64", 1/8", 9/64", 5/32", 3/16", 7/32", 1/4", 5/16", 3/8"



10 Pieces – Metric L-Key Set, Short Arm in Pouch
Set No. 9E69210



Part No.	Description
9E69210	Sizes: 1.3mm, 1.5mm, 2mm, 2.5mm, 3mm, 4mm, 5mm, 6mm, 8mm, 10mm



18 Pieces – Fractional L-Key Set, Short & Long Arm in Pouch
Set No. 9E69218



Part No.	Description
9E69218	Short Sizes: .050, 1/16", 5/64", 3/32", 7/64", 1/8", 9/64", 5/32", 7/32" Long Sizes: 1/16", 5/64", 3/32", 7/64", 1/8", 5/32", 3/16", 1/4", 5/16"



Hex Keys





18 Pieces – Fractional L-Key Set, Short Arm and Long Arm in Metal Box



Part No.	Description
9E10118	Short Sizes: .050, 1/16", 5/64", 3/32", 7/64", 1/8", 5/32", 3/16", 7/32" Long Sizes: 3/16", 5/64", 3/32", 1/8", 9/64", 5/32", 3/16", 1/4", 5/16"



15 Pieces – Metric L-Key Set, Short Arm in Metal Box



Part No.	Description
9E10515	Sizes: .7mm, .9mm, 1.3mm, 1.5mm, 2mm, 2.5mm, 3mm, 4mm, 5mm, 6mm, 8mm, 10mm, 12mm, 14mm, 17mm



13 Pieces – Fractional L-Key Set, Short Arm in Tool Holder



Part No.	Description
9E10113	Sizes: .050, 1/16", 5/64", 3/32", 7/64", 1/8", 9/64", 5/32", 3/16", 7/32", 1/4", 5/16", 3/8"



Hex Keys





13 Pieces – Fractional L-Key Set, Long Arm in Tool Holder Set No. 9E10213



Part No.	Description
9E10213	Sizes: .050, 1/16", 5/64", 3/32", 7/64", 1/8", 9/64", 5/32", 3/16", 7/32", 1/4", 5/16", 3/8"



9 Pieces – Metric L-Key Set, Short Arm in Tool Holder Set No. 9E10509



Part No.	Description
9E10509	Sizes: 1.5mm, 2mm, 2.5mm, 3mm, 4mm, 5mm, 6mm, 8mm, 10mm



9 Pieces – Metric L-Key Set, Long Arm in Tool Holder Set No. 9E10609



Part No.	Description
9E10609	Sizes: 1.5mm, 2mm, 2.5mm, 3mm, 4mm, 5mm, 6mm, 8mm, 10mm



Hex Keys





22 Pieces – Fractional & Metric L-Key Set, Long Arm in Tool Holder
Set No. 9E10222



Part No. Description

9E10222	Fractional Sizes: .050, 1/16", 5/64", 3/32", 7/64", 1/8", 9/64", 5/32", 3/16", 7/32", 1/4", 5/16", 3/8" Metric Sizes: 1.5mm, 2mm, 2.5mm, 3mm, 4mm, 5mm, 6mm, 8mm, 10mm
---------	---



6 Pieces – Metric Metal Fold-Up Set, Carded
Set No. 9E21151



Part No. Description

9E21151	Sizes: 3mm, 4mm, 5mm, 6mm, 8mm, 10mm
---------	--------------------------------------



7 Pieces – Metric Metal Fold-Up Set, Carded
Set No. 9E21171



Part No. Description

9E21171	Sizes: 1.5mm, 2mm, 2.5mm, 3mm, 4mm, 5mm, 6mm
---------	--



Hex Keys





5 Pieces – Fractional Metal Fold-Up Set, Carded Set No. 9E20511



Part No.	Description
9E20511	Sizes: 3/16", 7/32", 1/4", 5/16", 3/8"



8 Pieces – Fractional Metal Fold-Up Set, Carded Set No. 9E20811



Part No.	Description
9E20811	Sizes: .050, 1/16", 5/64", 3/32", 7/64", 1/8", 9/64", 5/32"



9 Pieces – Fractional Metal Fold-Up Set, Carded Set No. 9E20911



Part No.	Description
9E20911	Sizes: 5/64", 3/32", 7/64", 1/8", 9/64", 5/32", 3/16", 7/32", 1/4"



Hex Keys





**7 Pieces – Metric Resin
Fold-Up Set, Carded
Set No. 9E25172**



Part No. Description

9E25172 Sizes: 2mm, 2.5mm, 3mm, 4mm, 5mm, 6mm, 8mm



**6 Pieces – Fractional Resin
Fold-Up Set, Carded
Set No. 9E25611**



Part No. Description

9E25611 Sizes: 5/32", 3/16", 7/32", 1/4", 5/16", 3/8"



**8 Pieces – Torx Resin
Fold-Up Set, Carded
Set No. 9E25581**



Part No. Description

9E25581 Sizes: T-8, T-10, T-15, T-20, T-25, T-27, T-30, T-40



Hex Keys





9 Pieces – Fractional Resin Fold-Up Set, Carded Set No. 9E25911



Part No.	Description
9E25911	Sizes: 5/64", 3/32", 7/64", 1/8", 9/64", 5/32", 3/16", 7/32", 1/4"



9 Pieces – Fractional Resin Fold-Up Set, Carded Set No. 9E25912



Part No.	Description
9E25912	Sizes: .050, 1/16", 5/64", 3/32", 7/64", 1/8", 9/64", 5/32", 3/16"



9 Pieces – Fractional Vinyl Grip T-Handle Set, In Pouch Set No. 9E60609



Part No.	Description
9E60609	6" Long Hex Sizes: 5/64", 3/32", 7/64", 1/8", 9/64", 5/32", 3/16", 7/32", 1/4"



Hex Keys

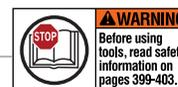



13 Pieces – Fractional Vinyl Grip T-Handle Set, In Metal Stand
Set No. 9E60614



Part No. Description

9E60614	6" Long Hex Sizes: .050", 1/16", 5/64", 3/32", 7/64", 1/8", 9/64", 5/32", 3/16", 7/32", 1/4", 5/16", 3/8",
---------	--



8 Pieces – Metric Vinyl Grip T-Handle, In Pouch
Set No. 9E64608



Part No. Description

9E64608	6" Long Metric Hex Sizes: 2mm, 2.5mm, 3mm, 4mm, 5mm, 6mm, 8mm, 10mm
---------	---



10 Pieces – Metric Vinyl Grip T-Handle Set, in Metal Stand
Set No. 9E64611



Part No. Description

9E64611	6" Long Metric Hex Sizes: 1.3mm, 1.5mm, 2mm, 2.5mm, 3mm, 4mm, 5mm, 6mm, 8mm, 10mm
---------	---



Hex Keys





8 Pieces – Fractional Loop Grip T-Handle Set, In Pouch Set No. 9E33198



Part No.	Description
9E33198	9" Long Hex Key Sizes: 3/32", 7/64", 1/8", 9/64", 5/32", 3/16", 7/32", 1/4"



5 Pieces – Metric Loop Grip T-Handle Metric Set, In Pouch Set No. 9E35195



Part No.	Description
9E35195	9" Long Metric Hex Key Sizes: 2.5mm, 3mm, 4mm, 5mm, 6mm



13 Pieces – Fractional Ball Driver Hex Set Set No. 9E13213



Part No.	Description
9E13213	Sizes: .050, 1/16", 5/64", 3/32", 7/64", 1/8", 9/64", 5/32", 3/16", 7/32", 1/4", 5/16", 3/8"



Hex Keys





9 Pieces – Metric Ball Driver Hex Set Set No. 9E13609



Part No.	Description
9E13609	Metric Sizes: 1.5mm, 2mm, 2.5mm, 3mm, 4mm, 5mm, 6mm, 8mm, 10mm



11 Pieces – Fractional Ball Driver T-Handle Set Set No. 9E60811



Part No.	Description
9E60811	Sizes: 5/64", 3/32", 7/64", 1/8", 9/64", 5/32", 3/16", 7/32", 1/4", 5/16", 3/8"



8 Pieces – Metric Ball Driver T-Handle Set Set No. 9E64808



Part No.	Description
9E64808	Metric Sizes: 2mm, 2.5mm, 3mm, 4mm, 5mm, 6mm, 8mm, 10mm



Hex Keys





**7 Pieces –
 Ballstar Torx Set
 Set No. 9E10007**



Part No.	Description
9E10007	Sizes: T-10, T-15, T-20, T-25, T-27, T-30, T-40

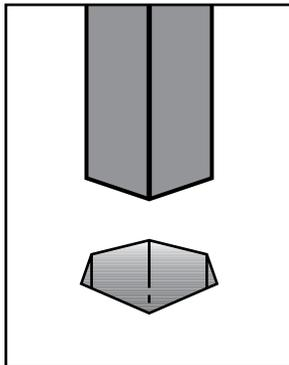

Hex

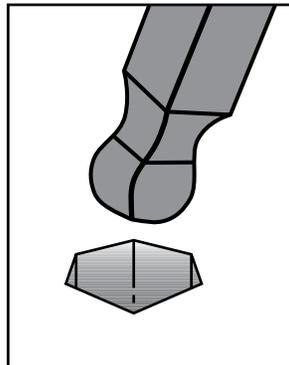

Ball End

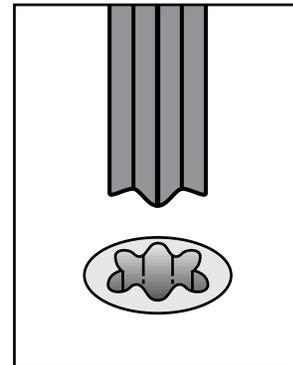

Torx

These make up the most complete line of key configurations available.

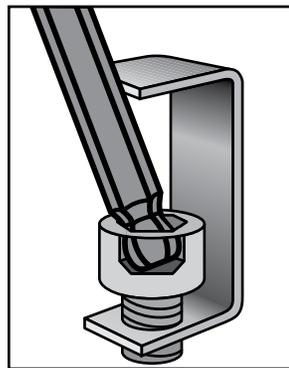

Angle Entry to 25°

- Works in hard to reach areas
- Faster insertion and removal

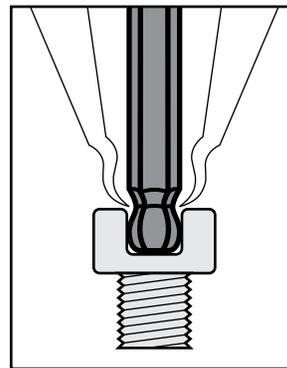

Fast Funnel Entry

- Eliminates wasted time even in blind applications
- Full depth engagement
- Reduces “stripping” problems

Hex Keys



PLIERS & SNIPS



Wright offers an extensive selection of pliers—from snap

ring pliers...to CHANNEL-LOCK™ tongue-and-groove

pliers...to many other popular styles. We also

offer PROSNIP™ aviation snips, metal cutting snips

and offset snips.

PLIERS & SNIPS.





W A R N I N G !

PLIERS & SNIPS

PLIERS

- Users and bystanders must wear safety goggles.
- To avoid possible eye injury from flying objects, safety goggles or equivalent protection conforming to ANSI Z87.1 shall be worn and kept clean by the user and all persons in the immediate area where any tool is being used.
- Comfort or plastic grips on handles are not intended to give any degree of protection against electric shock and pliers shall not be used on or near live electric circuits.
- Users shall apply a controlled force with a stance adjusted and braced to prevent rapid bodily movement or a fall if sudden release occurs.
- Choose the right plier for the job.
- Pliers shall not be used for cutting hardened wire unless specifically designed for this purpose.
- When cutting wire, always cut at right angles. Never rock from side to side or bend the wire back and forth against the cutting edges.
- Don't bend stiff wire with light pliers. Select the proper size plier.
- Pliers shall not be used on nuts or bolts. A wrench will do the job better and with less risk of damage to the fastener.
- Oil pliers occasionally at the joint only. Take care to keep the handles clean for a secure grip.
- Never use a plier for prying, punching, chiseling, scoring or scraping.
- Never hammer on pliers and never use a plier as a hammer.
- Never use cheater bars to increase leverage.
- Never expose any plier to excessive heat, which may change the hardness or microstructure and ruin the tool.
- Never use pliers on the handle of a screwdriver or nutdriver to get extra turning power.
- Inspect and discard bent, worn, cracked or damaged pliers. Do not grind or attempt to repair pliers.

SHEARS & SNIPS

- Users and bystanders must wear safety goggles.
- To avoid possible eye injury from flying objects, safety goggles or equivalent protection conforming to ANSI Z87.1 shall be worn and kept clean by the user and all persons in the immediate area where any tool is being used.
- Comfort or plastic grips on handles are not intended to give any degree of protection against electric shock and shall not be used on or near live electric circuits.
- Follow the manufacturer's instructions for use, capacity, and proper care of the snip.
- Be careful of the sharp cutting edges on the cutting blades. Keep blades closed when snip is not in use. Use safety latch to keep blades closed on available models.
- Be careful of the sharp edges of the material being cut when snips are used. Always wear gloves when working with snips.
- Never use a snip to cut sheet metal thicker than 1/16" (.062").
- Never use snips to cut heavy wire, cable, nails, rod, as these materials may damage the cutting edge or the shearing action of the snip.
- Use the right size and style of snip for the job. Do not cut tight curves with a straight pattern snip. Use offset models for long cuts through large sheets of material.
- Avoid springing the blades. This is the result of trying to cut material that is too thick.
- Use only hand pressure for cutting. Never hammer, use cheater bars or use feet to try and increase pressure.
- Do not attempt to re-sharpen a snip blade in a sharpening device designed for knives, scissors, or garden tools.

ASME B107.500 – Pliers

ASME B107.510 – Pliers & Shears

safety



Snap Ring Pliers

Features

- Patented push-button internal and external design...U.S. Patent #s 4280265 and 447675.
- Each Wright snap ring plier replaces a large number of limited-use competing tools...at a fraction of the cost.
- Patented broached jaw holes (6 point or 12 point) for holding replaceable tips.
- Patented ratchet lock on the Model 9H65 Plier.

Benefits for your Customers

- Quick and easy conversion to and from such use...without disassembly.
- High-quality - Cost Effective.
- Unprecedented accuracy, stability and control of retaining rings by including positive tip alignment and tip adjustment.
- Automatically keeps internal rings contracted and external rings expanded for easy installation and removal.



9H1221S



9H1234



9H65



9H87

Part No.	Description	Internal	External
9H1221S	Retaining Ring Plier w/Adjustable Stop and Replaceable Tips. Fits Internal and External Type Retaining Rings. Tips Color/Size Included: Black .038; Silver .047; Copper .023	Inch: 1/4"-1"	Inch: 1/8"-1"
9H1234	Retaining Ring Plier w/Replaceable Tips. Fits Internal and External Type Retaining Rings. Tips Color/Size Included: Black .038; Silver .047; Copper .070	Inch: 3/8"-2" Metric: 10mm-48mm	Inch: 1/4"-2" Metric: 10mm-48mm
9H65	Retaining Ring Plier w/Ratchet Lock. Fits Internal and External Type Retaining Rings. Tips Color/Size Included: Black .090; Silver .108; Copper .120	Inch: 1-13/16"-4" Metric: 31mm-100mm	Inch: 1-1/2"-4" Metric: 31mm-100mm
9H87	Retaining Ring Tool w/Automatic Lock-In Plastic Case. Fits Internal and External Type Retaining Rings. Tips Color/Size Included: Black .120; Silver .150; Copper .180	Inch: 3-1/2"-7" Metric: 90mm-175mm	Inch: 3-1/2"-7" Metric: 90mm-175mm





Snap-Ring Plier Replacement Kits

Part No.	Description
9H1221RK	Replacement tip kit for 9H1221S
9H1234RK	Replacement tip kit for 9H1234
9H65RK	Replacement tip kit for 9H65
9H8720	20 Degree Replacement tip kit for 9H87
9H8790	90 Degree Replacement tip kit for 9H87



9H1221RK



9H8720



9H65RK



9H8790

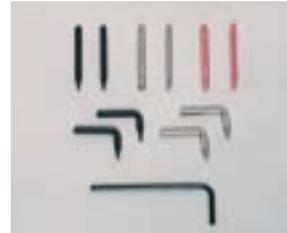

9H1234RK

3 Pieces – Snap Ring Plier Set No. 9H1265K

Part No.	Description
9H1221	Retaining Ring Plier
9H1234	Retaining Ring Plier
9H65	Retaining Ring Plier w/Ratchet Lock

Supplied in plastic box



Snap Ring Pliers/ Fixed Tip

Part No.	Tip Angle	Tip Diameter	Length
9C938	Straight Tip	.038	5.75"
9C938-90	90° Tip	.038	5.50"
9C947	Straight Tip	.047	5.75"
9C947-90	90° Tip	.047	5.50"
9C970	Straight Tip	.070	7.50"
9C970-90	90° Tip	.070	7.00"
9CQT-6	Six Piece Kit		



9C938-90, 9C947-90, 9C970-90



9C938, 9C947, 9C970



9CQT-6

Pliers & Snips





9465



9468



9470



9471



9472



9473

Safety Wire Twister Pliers

Part No.	Description
9465	8-3/8" Compact Safety Wire Twister Plier, Automatic - Clockwise rotation
9466	10-3/8" Standard Size, Automatic - Clockwise rotation
9467	10-3/8" Standard Size Manual return - deep reach Clockwise rotation
9468	Safety Wiring Kit - 8 Pieces - Professional Kit consisting of 9465 and 9466 - deep reach 19" adjustable twister tool - three 1/4 lb. spools of annealed stainless steel safety wire sizes .020-.032-.041 - meets Government Spec. QQW-423 Military Spec. MS 20995.

Stripper/Cutter Pliers

Part No.	Description
9470	Stripper/Cutter 10-20 AWG Metric sizes .8, 1.0, 1.3, 1.6, 2.6mm, with Locking Clip
9471	Stripper/Crimper/Cutter 10-20 AWG
9472	Crimper/Stripper/Cutter 16-26 AWG
9473	Stripper/Cutter 10-20 AWG Ergonomic Handle with Locking Clip



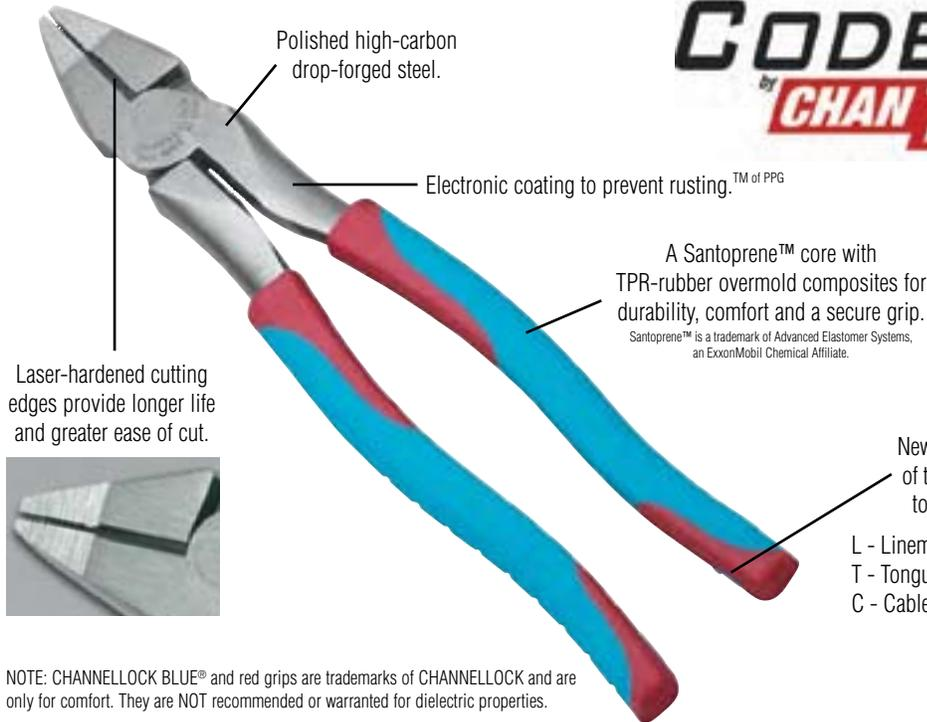

New Code Blue™ designation on each of the pliers makes it easier than ever to choose the right tool for the job.

- L - Linemen's
- T - Tongue and Groove
- C - Cable Cutter
- N - Needle-nose/Nipper
- D - Diagonal Cutter
- M - Multi-purpose Plier

NOTE: CHANNELLOCK BLUE® and red grips are trademarks of CHANNELLOCK and are only for comfort. They are NOT recommended or warranted for dielectric properties.

Tongue & Groove Plier



Part No.	Description	Size
9C430CB	Tongue & Groove Plier, 10" 7 Adjustments, 2" Capacity	10"



9C430CB

Tongue & Groove Plier



Part No.	Description	Size
9C420CB	Tongue & Groove Plier, 9-1/2" 5 Adjustments, 1-1/2" Capacity	9-1/2"



9C420CB

Linemen's Plier



Part No.	Description	Size
9C369CB	Linemen's Plier, 9" High Leverage/Rounded Nose	9"



9C369CB



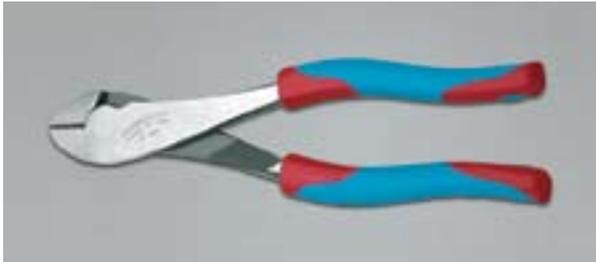

9C338CB

Cutting Plier



Part No.	Description	Size
9C338CB	Cutting Plier, 8" Lap Joint	8"

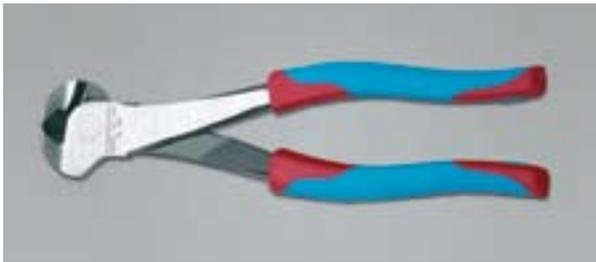

9C358CB

Cutting Plier



Part No.	Description	Size
9C358CB	Cutting Plier, 8" End Cutter	8"



9C911CB

Cable Cutter



Part No.	Description	Size
9C911CB	Cable Cutter, 9-1/2" Cable Cutter	9-1/2"



9C318CB

Long Nose Plier



Part No.	Description	Size
9C318CB	Long Nose Plier, 8-1/2" with Side Cutter	8-1/2"

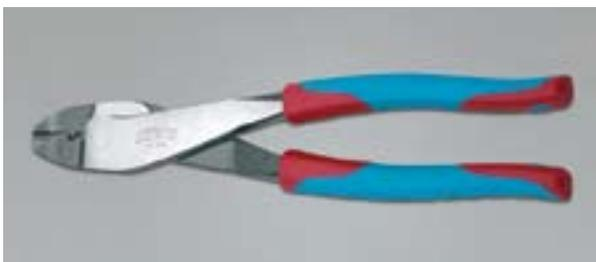

9C909CB

Crimping Tool



Part No.	Description	Size
9C909CB	Crimping Tool, 9-1/2" Crimping & Cutting Tool	9-1/2"





Tongue & Groove Pliers **CHANNEL LOCK**

Part No.	Description
9C410	9-1/2" Pipe Jaw (Channellock #410), Adjustments 4, Capacity 1-1/8" - 28.5mm
9C414	14" (Channellock #414), Adjustments 6, Capacity 2" - 51mm
9C420	9-1/2" (Channellock #420), Adjustments 5, Capacity 1-1/2" - 38mm
9C421	9-1/2" (Channellock #421), Adjustments 5, Capacity 1-1/2" - 38mm, SAFE-T-STOP® prevents finger pinch
9C422	9-1/2" Curved Jaw (Channellock #422), Adjustments 5, Capacity 1-1/2" - 38mm
9C424	4-1/2" (Channellock #434), Adjustments 3, Capacity 1/2" - 12.5mm
9C426	6-1/2" (Channellock #426), Adjustments 5, Capacity 7/8" - 22mm
9C428	8" (Channellock #428), Adjustments 4, Capacity 1-1/2" - 38mm, SAFE-T-STOP® prevents finger pinch
9C430	10" (Channellock #430), Adjustments 7, Capacity 2" - 51mm
9C440	12" (Channellock #440), Adjustments 7, Capacity 2-1/4" - 57mm
9C442	12" Curved Jaw (Channellock #442), Adjustments 7, Capacity 2-1/4" - 57mm
9C460	16" (Channellock #460), Adjustments 8, Capacity 4-1/4" - 108mm
9C480	20" (Channellock #480), Adjustments 12, Capacity 5-1/2" - 140mm
9CGL6	6" Griplock (Channellock #GL6), Adjustments 5, Capacity 1-1/16" - 27mm
9CGL10	10" Griplock (Channellock #GL10), Adjustments 5, Capacity 1-1/4" - 32mm
9CGL12	12" Griplock (Channellock #GL12), Adjustments 6, Capacity 2-1/4" - 57mm



9C410, 9C414



9C420, 9C421, 9C424, 9C426, 9C428, 9C430, 9C440, 9C460, 9C480



9C422, 9C442



9CGL6, 9CGL10, 9CGL12

Oil Filter/PVC Pipe Plier **CHANNEL LOCK**

Part No.	Description
9C212	Oil Filter / PVC Plier – 12" Adjustments: 5 Capacity: 2-3/4"-4-1/4"
9C215	Oil Filter / PVC Plier – 15" Adjustments: 6 Capacity: 2-1/2"-5-1/2"

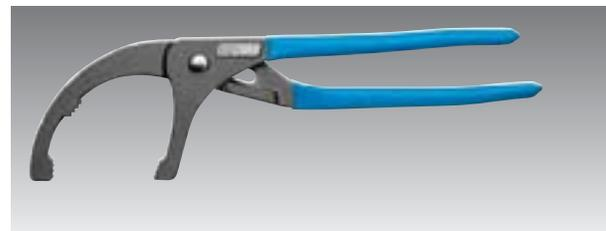

9C212, 9C215



Pliers & Snips





9C386



9C718



9C317, 9C318, 9C326



9C347, 9C348

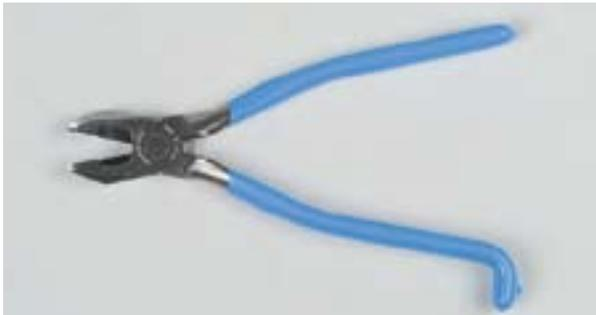

9C350S



9C349, 9C369

Long Nose Pliers

CHANNEL LOCK

Part No. Description

9C317	Long Nose Plier w/Side Cutter - 7-1/2" (Channellock #317)
9C318	Long Nose Plier w/Side Cutter - 8" (Channellock #318)
9C386	Curved Long Nose Plier w/Serrated Jaws - 6" (Channellock #386), Length 5-1/2" - 140mm Without Side Cutter
9C326	Long Nose Plier w/Side Cutter - 6" (Channellock #326)
9C718	Long Reach Flat Nose Duck Bill (Channellock #718)

Lineman's Pliers

CHANNEL LOCK

Part No. Description

9C347	Round Nose Lineman's & Elec. Plier (Round Nose) - 7" (Channellock #347)
9C348	Round Nose Lineman's & Elec. Plier (Round Nose) - 8" (Channellock - #348)
9C350S	Ironworkers Plier - 9" (Channellock #350)
9C349	Lineman's Plier, Wiremaster, 9" (Channellock #349)
9C369	Lineman's Plier, High Leverage, 9" (Channellock #369)



Pliers & Snips





Slip Joint Plier

CHANNELLOCK

Part No.	Description
9C526	Wire Cutting Shear - 6" (Channellock #526)
9C537	Slip Joint Plier - 7" (Channellock #537), Precision Tool with Fine Side Cutter
9C546	Heavy Duty Slip Joint Plier Wire Cutting Shears - 6" (Channellock #546)
9C548	Heavy Duty Slip Joint Plier Wire Cutting Shears - 8" (Channellock #548)



9C537



9C447



9C436



9C437



9C337, 9C338



9C911



9C357

Cutting Pliers

CHANNELLOCK

Part No.	Description
9C447	Curved Diagonal, Box Joint, 7-3/4" - (Channellock #447)
9C436	Box Joint 6" - (Channellock #436)
9C437	Box Joint 7" - (Channellock #437)
9C337	Lap Joint 7" - (Channellock #337)
9C338	Cutter Plier 8" Lap Joint (Channellock #338)
9C911	Cable Cutter 9-1/2" (Channellock #911) Cuts up to 4/0 aluminum and up to 2/0 soft copper. It is not designed for steel or ACSR.
9C357	Nipper 7" - (Channellock #357), End Cutter



Pliers & Snips





9C85

Fence Tool

CHAN NEL LOCK

Part No. Description

9C85 Fence Tool (Channellock #85)



9C558

Hose Clamp Plier

CHAN NEL LOCK

Part No. Description

9C558 Hose Clamp Tool 8" (Channellock #558)



9C909

Crimping Tool

CHAN NEL LOCK

Part No. Description

9C909 Crimping Tool (Channellock #909)



9P6716L, 9P6716R, 9P6716S

Aviation Snips

MIDWEST

Part No. Description

9P6716L Cuts Left 10" - Red

9P6716R Cuts Right 10" - Green

9P6716S Cuts Straight 10" - Yellow

9P6716B Bulldog Snips



9P6716B





Offset Snips



Part No. Description

9P6510L	Left Cutting
9P6510R	Right Cutting



9P6510L, 9P6510R

Metal Cutting Snips



Part No. Description

9P77S	Straight - 7"
9P107S	Straight - 10"
9P127S	Straight - 12"
9P77D	Duckbill - 7"
9P107D	Duckbill - 10"
9P127D	Duckbill - 12"



9P77S, 9P107S, 9P127S



9P77D, 9P107D, 9P127D





Curved Jaw with Wire Cutter Locking Pliers

WISE-GRIP®
LOCKING CLAMPS

Part No. Description

9V4WR	Miniature, 4-1/4" (Vise-Grip #4WR)
9V5WR	5" (Vise-Grip #5WR)
9V7WR	7" (Vise-Grip #7WR)
9V10WR	10" (Vise-Grip #10WR)



Long Nose with Wire Cutter Locking Pliers

WISE-GRIP®
LOCKING CLAMPS

Part No. Description

9V4LN	Miniature, 4" (Vise-Grip #4LN)
9V6LN	6" (Vise-Grip #6LN)
9V9LN	9" (Vise-Grip #9LN)



Curved Jaw Locking Pliers

WISE-GRIP®
LOCKING CLAMPS

Part No. Description

9V7CR	7" (Vise-Grip #7CR)
9V10CR	10" (Vise-Grip #10CR)





Straight Jaw Locking Pliers **WISE-GRIP**
LOCKING CLAMPS

Part No.	Description
9V7R	7" (Vise-Grip #7R)
9V10R	10" (Vise-Grip #10R)



Locking Wrench Plier **WISE-GRIP**
Vise Grip
LOCKING CLAMPS

Part No.	Description
9V4LW	Locking Wrench Plier Vise Grip (Vise Grip #4LW)
9V7LW	Locking Wrench Plier Vise Grip (Vise Grip #9V7LW)
9V10LW	Locking Wrench Plier Vise Grip (Vise Grip #9V10LW)



Locking C-Clamp Pliers **WISE-GRIP**
LOCKING CLAMPS

Part No.	Description	Jaw Adjustment	Throat Depth
9V4SP	With Swivel Pads 4" (Vise-Grip #4SP)	0" – 2"	1-1/4"
9V6SP	With Swivel Pads 6" (Vise-Grip #6SP)	0" – 2-1/8"	1-1/2"
9V11SP	With Swivel Pads 11" (Vise-Grip #11SP)	0" – 3-7/8"	2-5/8"
9V18SP	With Swivel Pads 18" (Vise-Grip #18SP)	0" – 8"	9-1/2"
9V24SP	With Swivel Pads 24" (Vise-Grip #24SP)	0" – 10"	15-1/2"
9V6R	6" (Vise-Grip #6R)	0" – 2"	1-1/2"
9V11R	11" (Vise-Grip #11R)	0" – 4"	2-5/8"
9V18R	Regular Tips 18" (Vise-Grip #18R)	0" – 8"	9-1/2"
9V24R	Regular Tips 24" (Vise-grip #24R)	0" – 12-1/2"	15-1/2"



9V4SP, 9V6SP, 9V11SP, 9V18SP, 9V24SP



9V6R, 9V11R, 9V18R, 9V24R





Locking Sheet Metal Tool **WISE-GRIP®** LOCKING CLAMPS

Part No.	Description	Jaw Adjustment
9V8R	Plier 8" (Vise-Grip #8R)	3-1/8"



Locking Welding Clamp Plier **WISE-GRIP®** LOCKING CLAMPS

Part No.	Description	Jaw Adjustment
9V9R	Plier 9" (Vise-Grip #9R)	2-3/4"



Locking Chain Clamp – Pipewrench **WISE-GRIP®** LOCKING CLAMPS

Part No.	Description
9V20R	Locking Chain Clamp - Pipewrench (Vise-Grip #20R) Chain Length 18"



REALLY BIG JOBS DEMAND REALLY BIG TOOLS

*The Leader In
Heavy-Duty Hand
Tools For Industry*

Big Wrenches – Openings up to 4" SAE and 80mm metric.

Big Ratchets – Heavy-duty, round-head design in all drive sizes.

Impact Sockets – Drive sizes range up to 3-1/2" in standard and deep lengths.

Impact Hex Bit Sockets – 3/8" and 1/2" drives.

Striking Face Box (Slugging) Wrenches – Straight and offset designs. Sizes to 4-5/8" and 80mm.

WrightGrip® Combination Wrenches – Sizes up to 1-1/4". Anti-slip design for more torque, higher strength, longer tool life.

Special Tools – Wright specializes in manufacturing specials. Contact us with your special requirements.

Custom Tool Kits – We can custom-design a set to meet your application.

Tool Safety DVD Program – Protect your employees' safety and protect your company against liability. Available in English or Spanish.

Professional Tools For Mining Applications.

Wright® heavy-duty hand tools are built big and tough for the most demanding mining applications. These U.S.-made, professional-grade tools are hot-forged for strength, quality, durability, performance and reliability. For your biggest jobs, turn to Wright Tool – the biggest name in sockets, ratchets, wrenches and attachments. We're the only source you need.

800-321-2902 • www.wrighttool.com/mining



WRIGHT TOOL
PERFECTING PERFORMANCE



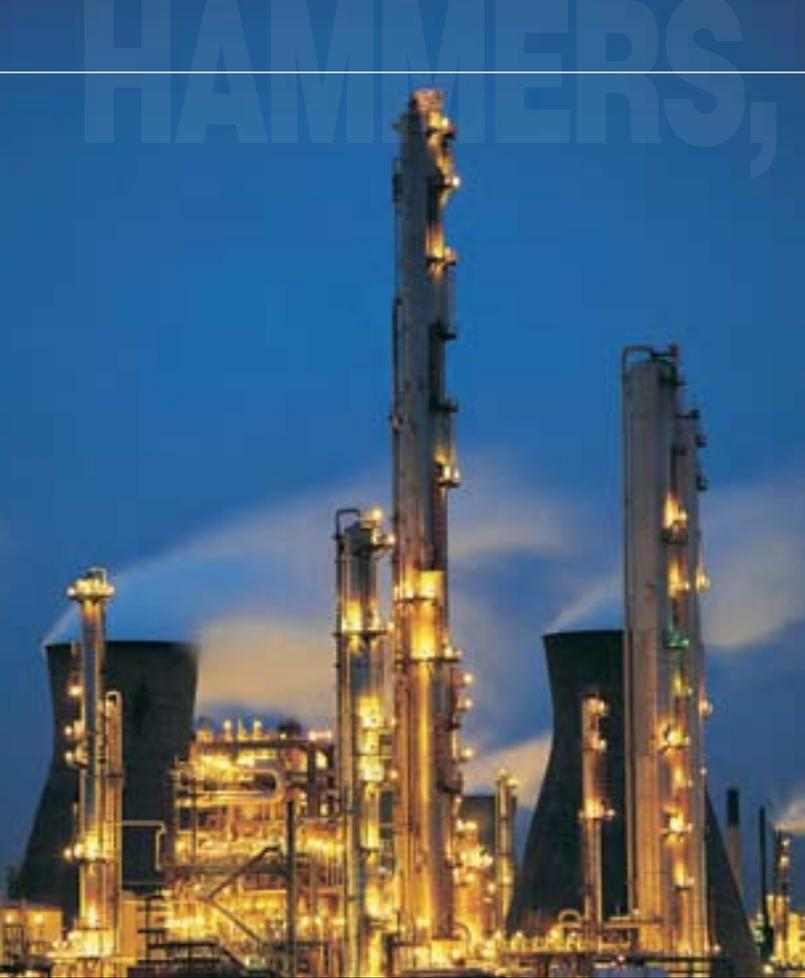

HAMMERS, PUNCHES & CHISELS

Wright has a full range of striking tools for various applications. Our selection includes NUPLA™ dead-blow, soft-face, brass, ball peen, and claw hammers; cross peen, short handle and double-face sledge hammers; and rubber mallets. Wood handled hammers include ball peen, cross peen, engineer and sledge. We also offer a wide selection of MAYHEW™ punches and chisels, sold individually and in sets.

HAMMERS, PUNCHES & CHISELS.

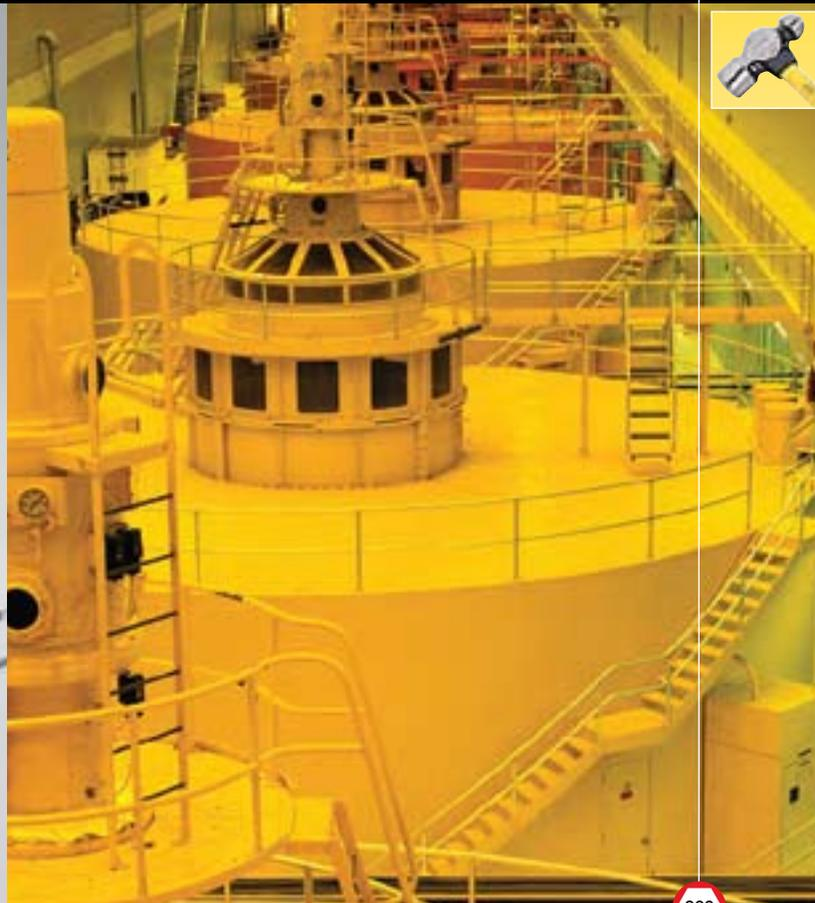



W A R N I N G !

HAMMERS

- Users and bystanders must wear safety goggles.
- To avoid possible eye injury from flying objects, safety goggles or equivalent protection conforming to ANSI Z87.1 shall be worn and kept clean by the user and all persons in the immediate area where any tool is being used.
- Comfort or plastic grips on handles are not intended to give any degree of protection against electric shock and shall not be used on or near live electric circuits.
- Hammer heads shall be inspected prior to each use and the hammer discarded if it shows chipping, dents, cracks, mushrooming or excessive wear.
- Inspect handles before each use. Never use a hammer with a loose or damaged handle.
- Hammer blows must be struck squarely to the surface being struck.
- Avoid glancing blows.
- When striking another tool (punch, chisel, wedge, etc.), the striking face of the proper hammer must have a diameter at least 3/8" larger than the face of the struck tool.
- Keep striking faces free of oil and grease.
- Never use one hammer to strike another hammer.
- Never strike with the side (cheek) of a hammer.
- Nail hammers are intended to drive or pull unhardened nails only.
- Never strike hardened objects with a nail hammer.
- Never use a soft face hammer to drive a nail or any hardened object.
- Use dead blow hammers to minimize vibration.
- Instructors and employers shall train users and stress proper lifting and swinging techniques for each striking tool application.
- No area, section, or portion of a hammer shall be ground, welded, reheated, or otherwise altered from its original shape.

PUNCHES, CHISELS, PRY BARS

- Users and bystanders must wear safety goggles.
- To avoid possible eye injury from flying objects, safety goggles or equivalent protection conforming to ANSI Z87.1 shall be worn and kept clean by the user and all persons in the immediate area where any tool is being used.
- Comfort or plastic grips on handles are not intended to give any degree of protection against electric shock and shall not be used on or near live electric circuits.
- Metal cutting chisels are special purpose tools designed and intended for the cutting, shaping, and removal of metal softer than the cutting edge of the chisel. To avoid possible bodily injury, chisels must not be used on objects as hard as or harder than the chisel cutting edge. Do not use chisels on stone or concrete.
- When using chisels, the cutting edge must be pointed away from the user and any bystanders. Keep hands away from the cutting edge.
- Chisels and punches must not be used for prying or wedging, and no surface of the punch or chisel can be struck other than the struck face.
- When striking a punch or chisel, the striking face of the proper hammer must have a diameter at least 3/8" larger than the struck face of the chisel or punch. A hammer blow must be struck squarely with the hammer face parallel with the struck face of the chisel or punch. Avoid glancing blows.
- Chisels, punches, and pry bars shall be inspected before each use and their use discontinued at the first sign of excessive wear, chipping, cracking, bending or mushrooming of any surfaces.
- Never use a chisel or punch with a mushroomed struck face, a bent stem, or a chipped, dull or deformed cutting edge or point.
- Never hammer a pry bar or use a pry bar as a hammer.
- No area, section, or portion of a chisel, punch, or pry bar shall be ground, welded, reheated, or otherwise altered from its original shape.
- Users shall apply a controlled force with a stance adjusted and braced to prevent rapid bodily movement or a fall if sudden release occurs. Users need to take extra care when using pry bars to avoid bar slippage. Users must also avoid bodily strain when using pry bars.
- The point end diameter of the starter punch or pin punch must approximate the size of the work piece.
- Pin punches must not be used as a starting (solid) punch.
- Drift or lining punches are special purpose tools intended for aligning and sizing holes and must not be used for driving metal or other hard objects.

ASME B107.400 – Striking Tools/Hammers

ASME B107.410 – Struck Tools





Dead Blow Hammers



Part No.	Description
9023	1 lb. with Super Grip (Nupla #10 -015)
9024	2 lbs. with Super Grip (Nupla #10 -025)
9025	3 lbs. with Super Grip (Nupla #10 -035)
9026	4 lbs. with Super Grip (Nupla #10 -045)

Steel Shot Filled Head



Rubber Mallet



Part No.	Description
9021	Rubber Mallet 1 lb. (Nupla #13-110)
9022	Rubber Mallet 2 lb. (Nupla #13-120)



Brass Hammer



Part No.	Description
9028	1.5 lbs. with Super Grip (Nupla #30-015)
9029	2.5 lbs. with Super Grip (Nupla #30 -025)
9065	4.0 lbs. with Super Grip (Nupla #30 -040)



Soft Face Hammers



Part No.	Description
9030	12 oz., 1.25" Tip Diameter (Nupla #11-225)
9031	21 oz., 1.375" Tip Diameter (Nupla #11-235)
9032	32 oz., 1.75" Tip Diameter (Nupla #11-275)

NOTE: All Nupla handles are fiberglass.





Replaceable Tips



Part No.	Description
9033	Holder Tip, Flat, Red, Medium Hardness, 1.25" (Nupla #15 -123)
9034	Holder Tip, Flat, Green, Tough Hardness, 1.25" (Nupla #15 -124)
9035	Holder Tip, Red, Medium Hardness, 1.375" (Nupla #15 -133)
9036	Holder Tip, Flat, Green, Tough Hardness, 1.375" (Nupla #15 -134) Green
9037	Holder Tip, Flat, Red, Medium Hardness, 1.75" (Nupla #15 -173) Red
9038	Holder Tip, Flat, Green, Tough Hardness, 1.75" (Nupla #15 -174) Green



Ball Peen Hammers, Fiberglass Handle



Part No.	Description
9040	8 oz. (Nupla #21-008)
9041	12 oz. (Nupla #21-012)
9042	16 oz. (Nupla #21-016)
9043	20 oz. (Nupla #21-020)
9044	24 oz. (Nupla #21-024)
9045	32 oz. (Nupla #21-032)



GGG-H86C

Ball Peen Hammers, Wood Handle

Part No.	Description
9014	12 oz. 12" Length
9015	16 oz. 14" Length
9016	24 oz. 15" Length
9017	32 oz. 16" Length



Claw & Ripping Hammers



Part No.	Description
9050	16 oz. Claw Hammer (Nupla #17-016)
9051	20 oz. Ripping Hammer - 14" Handle (Nupla #19-020)



NOTE: All Nupla handles are fiberglass.





Cross Peen Sledge Hammers Fiberglass Handle



Part No. Description

9053	3 lbs. Cross Peen Sledge Hammer - 14" Fiberglass Handle (Nupla #29-135)
9054	4 lbs. Cross Peen Sledge Hammer - 14" Fiberglass Handle (Nupla #29-145)



Cross Peen Sledge Hammers Wood Handle

Part No. Description

9077	2.5 lbs. Cross Peen Sledge Hammer - 15" Length
9078	3 lbs. Cross Peen Sledge Hammer - 15" Length
9079	4 lbs. Cross Peen Sledge Hammer - 15" Length



Small Drilling Hammer



Part No. Description

9052	3 lbs. with Super Grip (Nupla #28-035)
------	--



Short Handle Sledge Hammers Fiberglass Handle



Part No. Description

9061	6 lbs. - 16" (Nupla #27-805)
9062	8 lbs. - 16" (Nupla #27-804)
9063	10 lbs. - 16" (Nupla #27-092)
9064	12 lbs. - 16" (Nupla #27-096)



Sledge Hammers, Wood Handle

Part No. Description

9066	6 lbs. - 36" Length
9067	8 lbs. - 36" Length
9068	10 lbs. - 36" Length
9069	12 lbs. - 36" Length
9070	16 lbs. - 36" Length
9072	20 lbs. - 36" Length





Double Face Sledge Hammers



Part No.	Description
9055	3 lb. Double Face Sledge Hammer - 14" Handle (Nupla #27-530)
9056	4 lb. Double Face Sledge Hammer - 14" Handle (Nupla #27-540)
9057	6 lb. Double Face Sledge Hammer - 32" Handle (Nupla #27-806)
9060	8 lb. Double Face Sledge Hammer - 32" Handle (Nupla #27-808)
9058	10 lb. Double Face Sledge Hammer - 32" Handle (Nupla #27-810)
9059	12 lb. Double face Sledge Hammer - 32" Handle (Nupla #27-812)



NOTE: All Nupla handles are fiberglass.

Engineer Hammers Wood Handle

Part No.	Description
9047	2.5 lbs. - 15" Length
9048	3 lbs. - 15" Length
9049	4 lbs. - 15" Length

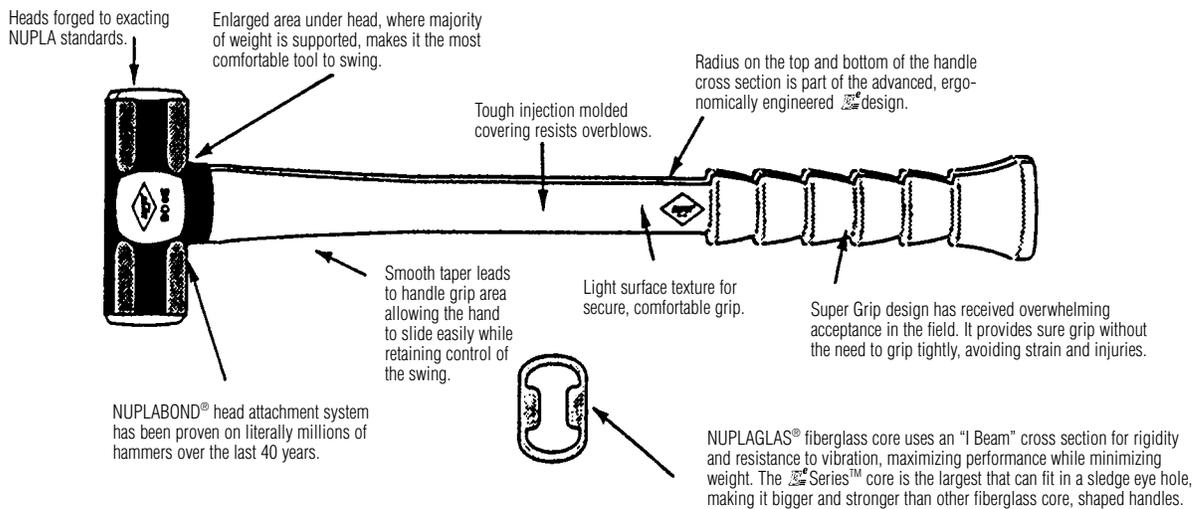

Punch & Chisel Sets



6 Pieces – Punch & Chisel Set Set No. 9660 – (Mayhem #751K)



This set contains six of the most commonly used punches and chisels.

Set No.	Description
9660	2 Cold Chisels 1/2", 5/8" 1 Center Punch 1 Starter Punch 2 Pin Punches 1/8", 3/16"



6 Pieces – Punch Set Set No. 9661 – (Mayhem #4106K)



Part No.	Description
9537	Center Punch 5/16" x 4-1/2" (Mayhem #415 5/16")
9553	Starter Punch 1/8" x 5" (Mayhem #400 1/8")
9556	Starter Punch 3/16" x 5" (Mayhem #400 3/16")
9564	Prick Punch 3/8" x 5" (Mayhem #485)
9594	Pin Punch 3/16" x 5-1/4" (Mayhem #413 3/16")
9596	Pin Punch 1/4" x 5-3/4" (Mayhem #413 1/4")

Supplied in Plastic Pouch



5 Pieces – Extra Long Pin Punch Set Set No. 9M62065 – (Mayhem #62065)



Part No.	Description
9598	Extra Long Pin Punch 3/16" x 3-1/2" Extra Long (8" Total Length)
9599	Extra Long Pin Punch 1/4" x 3-1/2" Extra Long (8" Total Length)
9M21500	Extra Long Pin Punch 1/8" x 3-1/2" Extra Long (8" Total Length)
9M21503	Extra Long Pin Punch 5/16" x 3-1/2" Extra Long (8" Total Length)
9M21504	Extra Long Pin Punch 3/8" x 3-1/2" Extra Long (8" Total Length)

Supplied in Plastic Pouch

NOTE: All handles are fiberglass.





**3 Pieces – Knurled Brass
 Drift Punch Set**
Set No. 9M61360 – (Mayhew #61630)



Part No. Description

9M25075	Knurled Brass Drift Punch 3/4" (Mayhew #25075)
9M25076	Knurled Brass Drift Punch 1/2" (Mayhew #25076)
9M25077	Knurled Brass Drift Punch 3/8" (Mayhew #25077)

Supplied in Plastic Pouch



6 Pieces – Cold Chisel Set
Set No. 9662 –
(Mayhew #7001K)



Part No. Description

9600	Cold Chisel 1/4" x 5" (Mayhew #70 1/4")
9601	Cold Chisel 5/16" x 5" (Mayhew #70 5/16")
9602	Cold Chisel 3/8" x 5-1/2" (Mayhew #70 3/8")
9603	Cold Chisel 1/2" x 6" (Mayhew #70 1/2")
9604	Cold Chisel 5/8" x 6-1/2" (Mayhew #70 5/8")
9605	Cold Chisel 3/4" x 7" (Mayhew #70 3/4")

Supplied in Plastic Pouch



**14 Pieces – Mechanics
 Punch & Chisel Set**
Set No. 9663 – (Mayhew #7014K)



Part No. Description

9600	Cold Chisel 1/4" x 5" (Mayhew #70 1/4")
9602	Cold Chisel 3/8" x 5-1/2" (Mayhew #70 3/8")
9603	Cold Chisel 1/2" x 6" (Mayhew #70 1/2")
9604	Cold Chisel 5/8" x 6-1/2" (Mayhew #70 5" x 8")
9605	Cold Chisel 3/4" x 7" (Mayhew #70 3/4")
9538	Center Punch 3/8" x 5" (Mayhew #415 3/8")
9553	Starter Punch 1/8" x 5" (Mayhew #400 1/8")
9556	Starter Punch 3/16" x 5" (Mayhew #400 3/16")
9581	Line-up Punch 1/8" x 8" (Mayhew #466 1/8")
9591	Pin Punch 3/32" x 4-1/2" (Mayhew #413 3/32")
9592	Pin Punch 1/8" x 4-3/4" (Mayhew #413 1" x 8")
9593	Pin Punch 3/16" x 5" (Mayhew #413 5/32")
9594	Pin Punch 3/16" x 5-1/4" (Mayhew #413 3/16")
9596	Pin Punch 1/4" x 5-3/4" (Mayhew #413 1/4")

Supplied in Plastic Pouch





**6 Pieces – Roll Pin Pilot
Punches Set**
Set No. 9680 – (Mayhew #62250)



Part No.	Description
9670	1/8 #4 Pilot Punch (Mayhew #25003)
9671	5/32 #5 Pilot Punch (Mayhew #25004)
9672	3/16 #6 Pilot Punch (Mayhew #25005)
9673	7/32 #7 Pilot Punch (Mayhew #25006)
9674	1/4 #8 Pilot Punch (Mayhew #25007)
9675	5/16 #9 Pilot Punch (Mayhew #25008)

Supplied in Plastic Pouch



**9 Pieces – Roll Pin Pilot
Punches Set**
Set No. 9681 – (Mayhew #62252)



Part No.	Description
9667	1/16 #1 Pilot Punch (Mayhew #25000)
9668	5/64 #2 Pilot Punch (Mayhew #25001)
9669	3/32 #3 Pilot Punch (Mayhew #25002)
9670	1/8 #4 Pilot Punch (Mayhew #25003)
9671	5/32 #5 Pilot Punch (Mayhew #25004)
9672	3/16 #6 Pilot Punch (Mayhew #25005)
9673	7/32 #7 Pilot Punch (Mayhew #25006)
9674	1/4 #8 Pilot Punch (Mayhew #25007)
9675	5/16 #9 Pilot Punch (Mayhew #25008)

Supplied in Plastic Pouch



**12 Pieces – Roll Pin Pilot
Punches Set**
Set No. 9682 – (Mayhew #62254)



Part No.	Description
9667	1/16 x 1 - Pilot Punch (Mayhew #25000)
9668	5/64 x 2 - Pilot Punch (Mayhew #25001)
9669	3/32 x 3 - Pilot Punch (Mayhew #25002)
9670	1/8 x 4 - Pilot Punch (Mayhew #25003)
9671	5/32 x 5 - Pilot Punch (Mayhew #25004)
9672	3/16 x 6 - Pilot Punch (Mayhew #25005)
9673	7/32 x 7 - Pilot Punch (Mayhew #25006)
9674	1/4 x 8 - Pilot Punch (Mayhew #25007)
9675	5/16 x 9 - Pilot Punch (Mayhew #25008)
9676	3/8 x 10 - Pilot Punch (Mayhew #25009)
9677	7/16 x 11 - Pilot Punch (Mayhew #25010)
9678	1/2 x 12 - Pilot Punch (Mayhew #25011)

Supplied in Plastic Pouch





**12 Piece Bench Set – Roll Pin
 Pilot Punches Set**
Set No. 9683 – (Mayhew #62258)



Part No.	Description
9683	12 Piece Set; contents same as 9682

Supplied in Wood Box



**Pilot Punches
 Display**
Set No. 9684 – (Mayhew #80000)



Part No.	Description
9684	Consists of: 3 each of 2 punch sizes 1/16 - 1/2 1 each sets: 9680, 9681, 9682



**4 Pieces – Line-Up
 Punch Set**
Set No. 9664 – (Mayhew #125K)



Part No.	Description
9581	Line-up Punch 1/8" x 8" (Mayhew #466 1/8")
9582	Line-up Punch 5/32" x 9" (Mayhew #466 5/32")
9583	Line-up Punch 3/16" x 10" (Mayhew #467 3/16")
9584	Line-up Punch 1/4" x 12" (Mayhew #466 1/4")

Supplied in Plastic Pouch



Punch & Chisel Sets



5 Pieces – Punch Set Set No. 9665 – (MayheW #4105K)



Part No.	Description
9556	Starter Punch 3/16" x 5" (MayheW #400 3/16")
9592	Pin Punch 1/8" x 4-3/4" (MayheW #413 1/8")
9593	Pin Punch 5/32" x 5" (MayheW #413 5/32")
9594	Pin Punch 3/16" x 5-1/4" (MayheW #413 3/16")
9596	Pin Punch 1/4" x 5-3/4" (MayheW #413 1/4")

Supplied in Plastic Pouch



24 Pieces – Master Punch & Chisel Set Set No. 9666 – (MayheW #7024K)



Part No.	Description
9600	Cold Chisel 1/4" x 5" (MayheW #70 1/4")
9601	Cold Chisel 5/16" x 5" (MayheW #70 5/16")
9602	Cold Chisel 3/8" x 5-1/2" (MayheW #70 3/8")
9603	Cold Chisel 1/2" x 6" (MayheW #70 1/2")
9604	Cold Chisel 5/8" x 6-1/2" (MayheW #70 5/8")
9605	Cold Chisel 3/4" x 7" (MayheW #70 3/4")
9612	Cape Chisel 1/4" x 5-1/2" (MayheW #150 1/4")
9622	Round Nose Chisel 1/4" x 5-1/2" (MayheW #250 1/4")
9538	Center Punch 3/8" x 5" (MayheW #415 3/8")
9552	Starter Punch 3/32" x 5" (MayheW #400 3/32")
9553	Starter Punch 1/8" x 5" (MayheW #400 1/8")
9555	Starter Punch 5/32" x 6" (MayheW #400 5/32")
9556	Starter Punch 3/16" x 5" (MayheW #400 3/16")
9557	Starter Punch 1/4" x 5" (MayheW #400 1/4")
9558	Starter Punch 5/16" x 6" (MayheW #401 5/16")
9563	Prick Punch 5/16" x 4-1/4" (MayheW #410 5/16")
9591	Pin Punch 3/32" x 4-1/2" (MayheW #413 3/32")
9592	Pin Punch 1/8" x 4-3/4" (MayheW #413 1/8")
9593	Pin Punch 5/32" x 5" (MayheW #413 5/32")
9594	Pin Punch 3/16" x 5-1/4" (MayheW #413 3/16")
9596	Pin Punch 1/4" x 5-3/4" (MayheW #413 1/4")
9597	Pin Punch 5/16" x 6" (MayheW #413 5/16")
—	Diamond Point Chisel 1/4" x 5-3/4" (MayheW #350 1/4")
—	Center Punch 1/2" x 6" (MayheW #416 1/2")



Supplied in Plastic Pouch

NOTE: Also includes MayheW #'s 350 1/4", Diamond Point Chisel (1/4" x 5-3/4") and 416 1/2", Center Punch (1/2" x 6")





Center Punches



Part No.	Description
9536	1/4" x 3-1/2" (Mayhew #415 1/4")
9537	5/16" x 4-1/2" (Mayhew #415 5/16")
9538	3/8" x 5" (Mayhew #415 3/8")
9539	1/2" x 6" (Mayhew #416 1/2")
9540	5/8" x 6-1/4" (Mayhew #416 5/8")



Roll Pin Pilot Punches



The Mayhew Pilot Punch is designed to apply equal pressure to the end of the pin thus driving it straight through the hole. The round ball on the center of the point end assures proper contact with the pin thereby eliminating any damage to the pin or hole wall. (Manufactured to +.000, -.010 tolerance). PATENT No. 3,099,876



Part No.	Description	Overall Length
9667	#1 1/16" (Mayhew #25000)	2-3/4"
9668	#2 5/64" (Mayhew #25001)	3-1/4"
9669	#3 3/32" (Mayhew #25002)	3-1/2"
9670	#4 1/8" (Mayhew #25003)	4"
9671	#5 5/32" (Mayhew #25004)	4-1/2"
9672	#6 3/16" (Mayhew #25005)	4-1/2"
9673	#7 7/32" (Mayhew #25006)	5"
9674	#8 1/4" (Mayhew #25007)	5-1/2"
9675	#9 5/16" (Mayhew #25008)	6"
9676	#10 3/8" (Mayhew #25009)	6"
9677	#11 7/16" (Mayhew #25010)	6"
9678	#12 1/2" (Mayhew #25011)	6"

Knurled Brass Drift Punches



Part No.	Description
9M25075	3/4" (Mayhew #25075)
9M25076	1/2" (Mayhew #25076)
9M25077	3/8" (Mayhew #25077)



Solid or Starter Punches



Part No.	Description
9552	3/32" x 5" (Mayhew #400 3/32")
9553	1/8" x 5" (Mayhew #400 1/8")
9555	5/32" x 6" (Mayhew #400 5/32")
9556	3/16" x 5" (Mayhew #400 3/16")
9557	1/4" x 5" (Mayhew #400 1/4")
9558	5/16" x 6" (Mayhew #401 5/16")



Punches & Chisels



Prick Punches



Part No. Description

9563	5/16" x 4-1/4" (Mayhew #410 5/16")
9564	3/8" x 5" (Mayhew #410 3/8")



Pry Bars with Handles



Part No. Description

Blade Length

9M60144

9M60140	Mayhew Dominator Curved Screwdriver-Style Pry Bar	7"
9M60144	Mayhew Dominator Curved Screwdriver-Style Pry Bar	12"
9M60146	Mayhew Dominator Curved Screwdriver-Style Pry Bar	18"
9M40138	Mayhew Dominator Curved Screwdriver-Style Pry Bar	36"
9M40139	Mayhew Dominator Curved Screwdriver-Style Pry Bar	42"
9M40164	Mayhew Dominator Curved Screwdriver-Style Pry Bar	44"
9M40162	Mayhew Dominator Curved Screwdriver-Style Pry Bar	58"
9M61355	Curved Screwdriver-Style Pry Bar 3 Pc. Set	



9M61355



Die Separating Bar



Part No. Description

9M41280	18" (Mayhew #41280)
9M41285	30" (Mayhew #41285)



Rolling Head Pry Bar



Part No. Description

9M481	3/8" x 9" (Mayhew #481)
9M482	1/2" x 16" (Mayhew #482)
9M483	5/8" x 18" (Mayhew #483)
9M484	3/4" x 22" (Mayhew #484)



Rolling Head Pry Bar (Lady Slipper)

Part No. Description

9M424	7/16" x 12"
9M426	9/16" x 16"
9M428	11/16" x 21"



Gooseneck Wrecking Bars



Part No. Description

9M705	5/8" x 18" (Mayhew #705/41001)
9M710	3/4" x 24" (Mayhew #710/41002)
9M715	3/4" x 30" (Mayhew #715/41003)
9M717	3/4" x 36" (Mayhew #717/41004)





9M740



9M745



9M750



Slotted Ripping Chisels



Part No. Description

9M740	3/4" x 18" (Mayhew #740/41200)
9M745	3/4" x 18" (Mayhew #745/41201)

Double Utility Bar



Part No. Description

9M750	14" (Mayhew #750/41300)
-------	-------------------------

Line-Up Pry Bars



Part No. Description

9575	1/2" x 14" (Mayhew #468)
9576	5/8" x 16" (Mayhew #469)
9577	3/4" x 20" (Mayhew #471)
9M472	3/4" x 24" (Mayhew #472)
9578	7/8" x 30" (Mayhew #473)
9M40022	7/8" x 38" (Mayhew #474)

Line-Up Punches



Part No. Description

9581	1/8" x 8" (Mayhew #466 1/8")
9582	5/32" x 9" (Mayhew #466 5/32")
9583	3/16" x 10" (Mayhew #467 3/16")
9584	1/4" x 12" (Mayhew #458 1/4")
9585	5/16" x 12" (Mayhew #458 5/16")
9586	3/8" x 15" (Mayhew #460 3/8")
9587	1/2" x 18" (Mayhew #464 1/2")



Punches & Chisels



Pin Punches

Part No.	Description
9590	1/16" x 4" (Mayhew #413 1/16")
9591	3/32" x 4-1/2" (Mayhew #413 3/32")
9592	1/8" x 4-3/4" (Mayhew #413 1/8")
9593	5/32" x 5" (Mayhew #413 5/32")
9594	3/16" x 5-1/4" (Mayhew #413 3/16")
9595	7/32" x 5-1/2" (Mayhew #413 7/32")
9596	1/4" x 5-3/4" (Mayhew #413 1/4")
9597	5/16" x 6" (Mayhew #414 5/16")



Extra Long Pin Punches

Part No.	Description
9M21500	1/8" x 3-1/2" Extra Long (8" Total Length)
9598	3/16" x 3-1/2" Extra Long (8" Total Length) (Mayhew #443 3/16")
9599	1/4" x 3-1/2" Extra Long (8" Total Length) (Mayhew #443 1/4")
9M21503	5/16" x 3-1/2" Extra Long (8" Total Length)
9M21504	3/8" x 3-1/2" Extra Long (8" Total Length)



Cold Chisels

Part No.	Description
9600	1/4" x 5" (Mayhew #70 1/4")
9601	5/16" x 5" (Mayhew #70 5/16")
9602	3/8" x 5-1/2" (Mayhew #70 3/8")
9M10204	7/16" x 6" (Mayhew #10204)
9603	1/2" x 6" (Mayhew #70 1/2")
9604	5/8" x 6-1/2" (Mayhew #70 5/8")
9605	3/4" x 7" (Mayhew #70 3/4")
9606	7/8" x 7-1/2" (Mayhew #70 7/8")
9607	1" x 8" (Mayhew #70 1")
9608	1/2" x 9" (Mayhew #110 1/2")
9609	3/4" x 12" (Mayhew #110 3/4")
9M10217	7/8" x 12" (Mayhew #10217)
9M10221	1" x 12" (Mayhew #10221)



Holder

Part No.	Description
9685	Punch & Chisel Holder





Cold Chisel With Guard



Part No. Description

9690	110-3/4 x 12 (Mayhew #85213)
9691	110-7/8 x 12 (Mayhew #85217)
9692	110-1 x 12 (Mayhew #85220)
9693	50-1 x 8 (Mayhew #85221)



Cape Chisels



Part No. Description

9610	1/8" x 5-1/2" (Mayhew #150 1/8")
9611	3/16" x 5-1/2" (Mayhew #150 3/16")
9612	1/4" x 5-1/2" (Mayhew #150 1/4")
9613	5/16" x 6-1/4" (Mayhew #150 5/16")
9614	3/8" x 7" (Mayhew #150 3/8")
9615	1/2" x 8" (Mayhew #150 1/2")



Round Nose Chisels



Part No. Description

9620	1/8" x 5-1/2" (Mayhew #250 1/8")
9621	3/16" x 5-1/2" (Mayhew #250 3/16")
9622	1/4" x 5-1/2" (Mayhew #250 1/4")
9623	5/16" x 6-1/4" (Mayhew #250 5/16")
9624	3/8" x 7" (Mayhew #250 3/8")
9625	1/2" x 8" (Mayhew #250 1/2")



Rivet Buster



Part No. Description

9627	(Mayhew #854 - 3/4")
------	----------------------



9627

Nail Puller



Part No. Description

9M720	Single End 5/8" x 10-1/8" (Mayhew #720)
9M725	Double End 5/8" x 10-1/2" (Mayhew #725)



9M720



9M725

NOTE: All Mayhew products meet ANSI Specification B209.1 1979
Federal Specification: Chisels: GGG-6-3136; Punches: GGG-P-831E



CLAMPS



Our C-clamp selection is designed to meet all

of your clamping requirements. Choose from

deep-throat and extra-deep throat styles;

heavy-service and extra-heavy-service clamps.

CLAMPS.





W A R N I N G !

C-CLAMPS

- Users and bystanders must wear safety goggles.
- To avoid possible eye injury from flying objects, safety goggles or equivalent protection conforming to ANSI Z87.1 shall be worn and kept clean by the user and all persons in the immediate area where any tool is being used.
- Select C-clamps of proper size and capacity to handle the job.
- Always inspect clamps before using. Never use a C-clamp with:
 - Bent, twisted or cracked frame
 - Badly worn threads on spindle
 - Bent or cracked spindle
 - Swivel pads badly worn, not turning freely, or missing from spindle
- Never use a hammer or pipe extension to tighten a C-clamp; only tighten to prevent slippage. If a wrench is used on a C-clamp, do not exceed the recommended "nominal clamping pressure."
- Never use a C-clamp as a permanent holding device; always use a clamp only as a temporary holding tool.
- Never use a C-clamp to secure loads on moving vehicles.
- Never use a C-clamp with chain, strap, cable or hook to lift or move a load or work object.
- Never use a C-clamp to hoist or support any scaffolding.
- Never use a C-clamp as a safety eye hold.
- Never weld any parts of a C-clamp to other metal objects.
- Store C-clamps by clamping them in a rack, not in a drawer.





Deep Throat Forged Steel Body Clamps

Part No.	Max. Opening	Min. Depth*	Screw Dia.	Test Load	Weight Per Box
90402B	2"	0"	2"	1/2"	3,500 Lbs. 1-1/2 Lbs.
90403B	3"	0"	2-3/8"	5/8"	3,500 Lbs. 1-3/4 Lbs.
90404B	4"	0"	2-3/4"	3/4"	6,500 Lbs. 2-3/4 Lbs.
90406B	6"	0"	3-5/8"	3/4"	6,900 Lbs. 4-3/4 Lbs.
90408B	8"	0"	4-1/2"	3/4"	6,900 Lbs. 8-1/2 Lbs.
90410B	10"	0"	5-3/8"	7/8"	8,000 Lbs. 10-1/2 Lbs.
90412B	12"	0"	5-3/4"	7/8"	9,500 Lbs. 14 Lbs.

Conforms to Federal Specification GGG-C-406D, Type 1, Class A, light service, deep throat. Threads on our screws are Acme roll-threaded for maximum strength and clamping force.



Deep Throat Forged Steel Body Clamps – Copper Screw

Part No.	Max. Opening	Min. Depth*	Screw Dia.	Test Load	Weight Per Box
90402C	2"	0"	2"	1/2"	3,500 Lbs. 1-1/2 Lbs.
90403C	3"	0"	2-3/8"	5/8"	3,500 Lbs. 1-3/4 Lbs.
90404C	4"	0"	2-3/4"	3/4"	6,500 Lbs. 2-3/4 Lbs.
90406C	6"	0"	3-5/8"	3/4"	6,900 Lbs. 4-3/4 Lbs.
90408C	8"	0"	4-1/2"	3/4"	6,900 Lbs. 8-1/2 Lbs.
90410C	10"	0"	5-3/8"	7/8"	8,000 Lbs. 10-1/2 Lbs.
90412C	12"	0"	5-3/4"	7/8"	9,500 Lbs. 14 Lbs.

Conforms to Federal Specification GGG-C-406D, Type 1, Class A, light service, deep throat. Spatter-resisting copper plated screw, swivel and crosspin for welding applications.



Extra Deep Throat Forged Steel Clamps (Copper Screw)

Forged steel frame and deep throat design makes this an excellent clamp for deep reach, light service. Screw swivel and crosspin are copper plated.

Part No.	Opening Depth*	Screw Dia.	Test Load	Weight Each
90404E	4" x 4"	3/4"	4,400 Lbs.	4-3/4 Lbs.
90406E	6" x 5"	3/4"	5,400 Lbs.	6-3/4 Lbs.
90408E	8" x 6"	3/4"	5,900 Lbs.	10-3/4 Lbs.

Conforms to Federal Specification GGG-C-406D, Type 1, Class A, light service, deep throat.

*Depth is from center of screw to frame.





Heavy Service Forged C-Clamps

Recommended for heavy industrial and construction work demanding extra strength. Drop forged from selected steel and accurately heat-treated. Steel swivels are securely attached to hardened steel screws.

Part No.	Max. Opening	Min. Depth*	Screw Dia.	Test Load	Weight Per Box
90102	2"	0"	1-1/2"	7,500 Lbs.	1-1/2 Lbs.
90103	3"	0"	2"	8,500 Lbs.	3 Lbs.
90104	4"	0"	2-3/8"	10,000 Lbs.	4-1/2 Lbs.
90106	6"	0"	2-1/2"	11,250 Lbs.	5-1/2 Lbs.
90108	8"	0"	2-5/8"	12,500 Lbs.	7-1/4 Lbs.
90110	10"	0"	2-3/4"	13,750 Lbs.	9-1/4 Lbs.
90112	12"	0"	2-7/8"	15,000 Lbs.	11-1/2 Lbs.

Conforms to Federal Specification GGG-C-406D, Type 1, Class B, medium service.



Extra Heavy Service Forged C-Clamps

Frame is forged from high-strength, heat-treated steel. Large diameter screws are full length and hardened to prevent bending and protect threads. Clamp strengths exceed test loads shown.

Part No.	Max. Opening	Min. Depth*	Screw Dia.	Test Load	Weight Per Box
90102H	2-1/4"	0"	1-7/8"	12,500 Lbs.	3-3/4 Lbs.
90103H	3-1/4"	0"	2-1/2"	16,250 Lbs.	6-1/2 Lbs.
90104H	4-1/2"	0"	2-3/4"	20,000 Lbs.	10 Lbs.
90105H	5-1/2"	0"	3-1/8"	23,800 Lbs.	13 Lbs.
90106H	6-1/2"	0"	3-3/8"	27,500 Lbs.	17 Lbs.
90108H	8-1/2"	0"	3-3/4"	31,250 Lbs.	24 Lbs.
90110H	10-1/2"	0"	4-1/8"	35,000 Lbs.	29 Lbs.
90112H	12-1/2"	0"	4-1/2"	40,000 Lbs.	40 Lbs.

Conforms to Federal Specification GGG-C-406D, Type 1, Class B, heavy service.



*Depth is from center of screw to frame.





If there's anything else you need in the way of tools,

look to Wright first. We offer a broad assortment of

miscellaneous tools—everything from hacksaws and

measuring tapes to feeler gauges and inspection mirrors.

We're the right source for all of your hand tool needs.

MISCELLANEOUS TOOLS & ACCESSORIES.

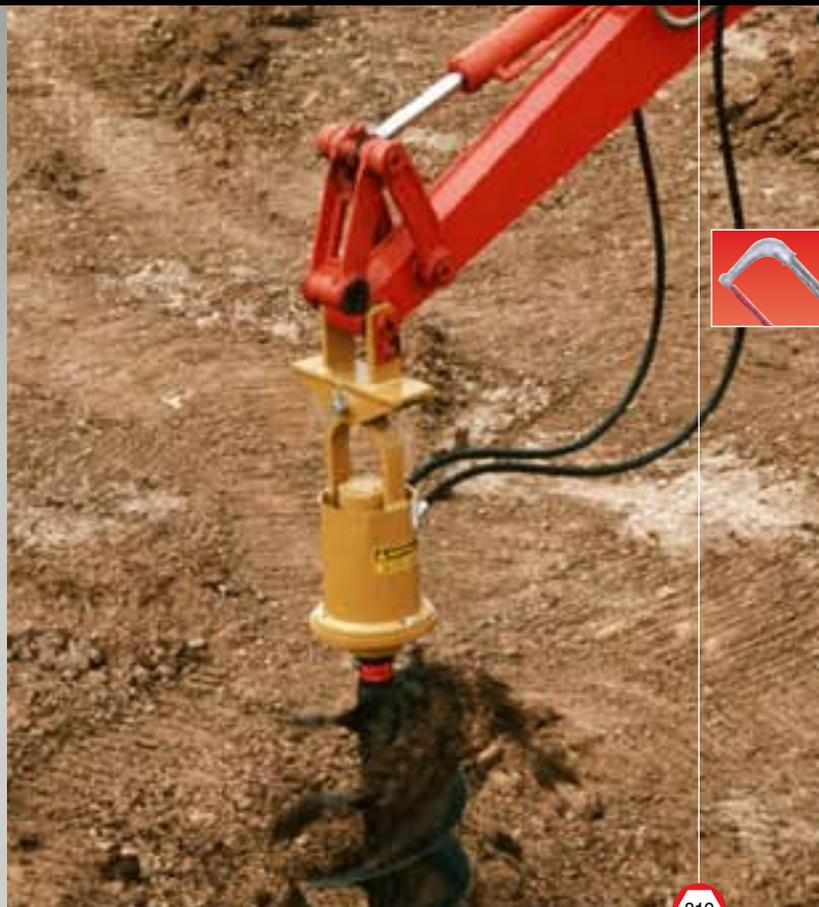



W A R N I N G !

MISCELLANEOUS TOOLS & ACCESSORIES

- Users and bystanders must wear safety goggles.
- To avoid possible eye injury from flying objects, safety goggles or equivalent protection conforming to ANSI Z87.1 shall be worn and kept clean by the user and all persons in the immediate area where any tool is being used.
- Comfort or plastic grips on handles are not intended to give any degree of protection against electric shock and shall not be used on or near live electric circuits.
- Users shall apply a controlled force with a stance adjusted and braced to prevent rapid bodily movement or a fall if sudden release occurs.
- Never hammer or pry with scrapers, utility knives or extractors. Never use scrapers or utility knives as screwdrivers.
- Keep blades of utility knives and razor scrapers retracted in the housing except during use. Do not use dull blades. Keep free hand away from cutting edge.
- Hacksaw blades shall be taut. Do not use dull saw blades. Keep free hand away from the saw blade when sawing.
- No area, section or portion of hacksaws, utility knives, scrapers or extractors shall be ground, welded, heated or altered from their original condition.
- Prior to each use, hacksaws, utility knives, scrapers and extractors shall be inspected and their use discontinued at the first sign of bending or wear.
- Do not open tape measure cases. The tape is under spring tension.
- Control the retraction of the measuring tape to prevent injury to hands or other bodily parts.



Miscellaneous

safety



Wright Stud Remover

A compact and powerful tool that fits into hard-to-reach spots and loosens hard-to-turn studs. The tighter the stud, the more firmly it is gripped. All high grade heat treated alloy steel. Fits flush, pulls 1/4" to 3/4" studs broken off close to the surface. Operates with any 1/2" square.

Part No.	Description
9020	Stud Remover



Flange Jacks

Easy effort flange spreaders. Flanges are separated smoothly and evenly with no damage to flange faces. Sold in pairs.

Dia. Capacity in Inches – Standard Raised Face Flanges

Part No.	Description	125 lb.		250 lb.	
		Cast Iron	150 lb. Steel	Cast Iron	300 lb. Steel
9460	1 PR.	2 to 20	2 to 20	1 to 12	3/4 to 12
9461	1 PR.	16 to 48	18 to 24	12 to 30	12 to 24



8 Pieces – Torx Set Set No. 9295

Part No.	Description	Part No.	Description
9271	Torx T-8	9276	Torx T-27
9272	Torx T-10	9277	Torx T-30
9273	Torx T-15	9280	1/4" Hex x 1/4"
9274	Torx T-20		Sq. Dr. Bit Holder
9275	Torx T-25		

Skinpacked



7 Pieces – Torx Set Set No. 9296

Part No.	Description	Part No.	Description
9281	6mm Ribe	9285	Torx T-47
9282	Torx T-30	9286	Torx T-50
9283	Torx T-40	9290	5/16" Hex x 3/8"
9284	Torx T-45		Sq. Dr. Bit Holder

Skinpacked



7 Pieces – Torx Set Set No. 9297

Part No.	Description	Part No.	Description
9250	E-6 Torx Socket	9256	E-12 Torx Socket
9251	E-7 Torx Socket	9257	E-14 Torx Socket
9252	E-8 Torx Socket	9258	E-16 Torx Socket
9255	E-10 Torx Socket		Skinpacked





1/4" Drive Torx Sockets

Part No.	Dr. Sq. Size	Shape	Head Size	L	Ds	Dd
9250	1/4"	I	E-6	1-1/16"	5/16"	1/2"
9251	1/4"	I	E-7	1-1/16"	3/8"	1/2"
9252	1/4"	I	E-8	1-1/16"	13/32"	1/2"

Refer to socket dimensional drawings on page 117.



3/8" Drive Torx Sockets

Part No.	Dr. Sq. Size	Shape	Head Size	L	Ds	Dd
9255	3/8"	I	E-10	1-1/4"	1/2"	11/16"
9256	3/8"	I	E-12	1-1/4"	5/8"	11/16"
9257	3/8"	II	E-14	1-1/4"	11/16"	-
9258	3/8"	II	E-16	1-1/4"	3/4"	-

Refer to socket dimensional drawings on page 156.



1/4" Drive Torx Bits

Part No.	Hex Size	Shape	Bit Size	L
9271	1/4"	II	T-8	1"
9272	1/4"	II	T-10	1"
9273	1/4"	II	T-15	1"
9274	1/4"	II	T-20	1"
9275	1/4"	II	T-25	1"
9276	1/4"	II	T-27	1"
9277	1/4"	II	T-30	1"

Refer to socket dimensional drawings on page 117.



1/4" Drive Bit Holders

Part No.	Dr. Sq. Size	Shape	Head Size	L	Ds	Dd
9280	1/4"	III	1/4"	1"	1/2"	1/2"

Refer to socket dimensional drawings on page 117.



Torx Bit Holders

Part No.	Dr. Sq. Size	Shape	Hex Size	L	Ds	Dd
9290	3/8" Dr. 5/16"	I	5/16"	1-1/4"	9/16"	11/16"
9292	3/8" Dr. 7/16"	I	7/16"	1-1/2"	7/8"	11/16"

Refer to socket dimensional drawings on page 156.



Miscellaneous





5/16" Torx Bits for 3/8" Dr. Holder

Part No.	Hex Size	Shape	Bit Size	L
9281	5/16"	I	6mm Ribe	1-1/8"
9282	5/16"	II	T-30	1-1/8"
9283	5/16"	II	T-40	1-1/8"
9284	5/16"	II	T-45	1-1/8"
9285	5/16"	II	T-47	1-1/8"
9286	5/16"	II	T-50	1-1/8"

Refer to socket dimensional drawings on page 156.



1/2" Torx Bits

Part No.	Hex Size	Shape	Bit Size	L
9287	7/16"	I	T-55	1-3/8"

Refer to socket dimensional drawings on page 191.



1/2" Drive Bit Holder

Part No.	Dr. Sq. Size	Shape	Head Size	L	Ds	Dd
9291	1/2"	III	7/16"	1-1/2"	7/8"	11/16"

Refer to socket dimensional drawings on page 191.



1/2" Square Drive Torx Driver

Part No.	Hex Size	Shape	Bit Size	L
9288	1/2"	II	T-60	2-1/8"

Refer to socket dimensional drawings on page 191.





9M60001

Gasket Scrapers



Part No.	Description
9M42004	Mayhem Dominator Carbon Scraper, 1/2"
9M42005	Mayhem Dominator Carbon Scraper, 3/4"
9M42006	Mayhem Dominator Carbon Scraper, 1"
9M42007	Mayhem Dominator Carbon Scraper, 1-1/2"
9M60001	Mayhem Dominator 4 Pc. Carbon Scraper Set



9M60000

Picks, Hooks & Awls



Part No.	Description
9M42000	Mayhem Dominator Scratch Awl
9M42001	Mayhem Dominator 90 Degree Hook
9M42002	Mayhem Dominator Curved Hook
9M42003	Mayhem Dominator Complex Hook
9M60000	Mayhem Dominator 4 Pc. Hook & Pick Set

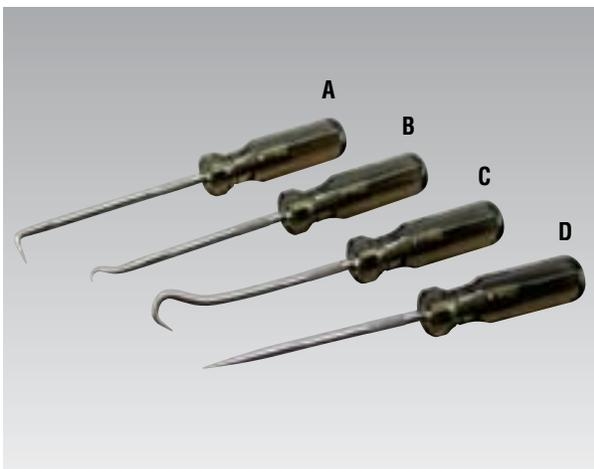

9UPSP4

**Mini Picks
Hooks & Awls Set**

Part No.	Description
9UPSP4	4-Piece Hook & Pick Set A - Pick B - Combination Pick C - Hook Pick D - Straight Pick



Miscellaneous





Scrapers/Putty Knives



Part No.	Description
9488	Flexible Blade 1-1/4" (Hyde #02000)
9489	Flexible Blade 3" (Hyde #02350)
9491	Stiff Blade 1-1/4" (Hyde #02050)



Heavy-Duty Scraper



Part No.	Description
9487	Polypropylene 8" Handle Scraper, 3" Blade (Hyde #12050)



Razor Scraper



Part No.	Description
9492	Razor Scraper (Hyde #13000)



Utility Knife



Has a retractable blade which holds in four positions. Handle stores additional blades.

Part No.	Description
9526	Top-Slide Utility Knife (Hyde #42070)
9525	Utility Knife Blades (10 Pack)



Safety Utility Knife



Part No.	Description
9527	Safety Utility Knife - Skinpacked (Hyde #42065)





Spiral Thread Screw Extractor Set

Set designed for easy removal of broken studs. Will back out all of those stubborn bolts. Set of 5 sizes, in a blister pack.

Part No.	Size	Screw or Bolt Size
9G95202	1	1/8" - 1/4"
	2	1/4" - 5/16"
	3	5/16" - 7/16"
	4	7/16" - 9/16"
	5	9/16" - 3/4"



Spiral Thread Screw Extractors

Part No.	Size	Screw or Bolt Size
9G85101	1	1/8" - 1/4"
9G85102	2	1/4" - 5/16"
9G85103	3	5/16" - 7/16"
9G85104	4	7/16" - 9/16"
9G85105	5	9/16" - 3/4"



Safety DVD

Part No.	Description
9307	Safety DVD

Additional information available on web site



Safety Goggles

Part No.	Description
9302	Safety Goggles



HTI Safety Book

Part No.	Description
9301	Hand Tool Institute Safety Book

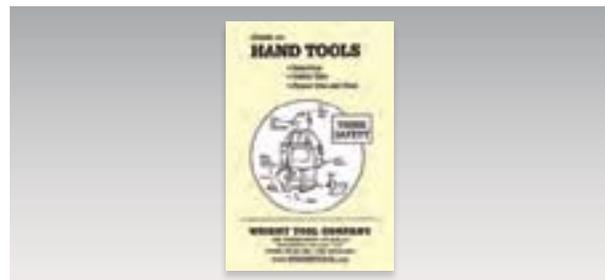

Miscellaneous





Metric Feeler Gauges – 10-Blade Gauge

Part No.	Description
9528	Feeler Gauge 10 Blade SAE Contains 10 Blades of the following thicknesses:
	.012 (0.30mm) .005 (0.13mm)
	.010 (0.25mm) .004 (0.10mm)
	.008 (0.20mm) .003 (0.8mm)
	.007 (0.18mm) .002 (0.05mm)
	.006 (0.15mm) .015 (0.38mm)



Metric Feeler Gauges – 25-Blade Gauge

Part No.	Description
9529	Feeler Gauge 25 Blade Metric Contains 25 Blades of the following thicknesses:
	0.04mm 0.15mm 0.50mm 0.85mm
	0.05mm 0.20mm 0.55mm 0.90mm
	0.06mm 0.25mm 0.60mm 0.95mm
	0.07mm 0.30mm 0.65mm 1.00mm
	0.08mm 0.35mm 0.70mm
	0.09mm 0.40mm 0.75mm
	0.10mm 0.45mm 0.80mm



Feeler Gauges – 25-Blade Master Gauge

Part No.	Description
9530	Contains 25 3-5/16" x 1/2" blades of the following thicknesses:
	.0015mm .008mm .015mm .028mm
	.002mm .009mm .016mm .030mm
	.003mm .010mm .018mm .032mm
	.004mm .011mm .020mm .035mm
	.005mm .012mm .022mm
	.006mm .013mm .024mm
	.007mm .014mm .025mm





Feeler Gauges – New Style Spark Plug Wire Gauge

Part No.	Description								
9531	Wire Gap Gauge New style spark plug wire gauge. It is designed for longer and heavier usage. Contains 1 electrode bender and 8 wire gauges of the following thicknesses: <table border="0" style="margin-left: 20px;"> <tr> <td>.020</td> <td>.028</td> <td>.032</td> <td>.035</td> </tr> <tr> <td>.025</td> <td>.030</td> <td>.034</td> <td>.040</td> </tr> </table>	.020	.028	.032	.035	.025	.030	.034	.040
.020	.028	.032	.035						
.025	.030	.034	.040						



Scratch Brush

Part No.	Description
9493	14" Long, Brush Length - 6"



Steel Tapes

Part No.	Description
9505	1" x 26', 8m
9507	3/4" x 16'
9508	1" x 25'
9509	3/8" x 100'
9510	1" x 30'



Hacksaw

An adjustable hacksaw. Converts to either 10 or 12 inches.

Part No.	Description
9523	Heavy Duty Hacksaw





Replaceable Hacksaw Blades

Part No.	Description
----------	-------------

9521	Hacksaw Blade 12" Bi-Metal, 20/24T
9522	Hacksaw Blade 12" Bi-Metal, 18T

Sold in packages of 10 only



Magnetic Pickup Tools

Multi-angle telescoping magnetic pickup tool. Gets into hard-to-reach places.

Part No.	Description
----------	-------------

9534	Flexible Magnetic Retrieving Tool, 19-1/2"
9535	17" Closed Length, Telescopes to 27" (not pictured)

Pick-up capacity 21 oz.

9534



9535



Lighted Pickup Tool

Part No.	Description
----------	-------------

9M45004	Lighted Pickup Tool (Mayhew #45044)
---------	-------------------------------------



Drum Cap Opening Tool

Part No.	Description
----------	-------------

9005	Drum Cap Opening Tool Fits 55 and 30 gallon drums. Removes "screw-in" style plugs (caps) for most steel and plastic drums with large and small plugs. Handy, built-in "two-hand" twist handle easily helps open the tightest plugs. Fits all twelve (12) drum plugs (bungs) illustrated at left. Packed bulk-weight 3.0 Lbs. each.
------	---

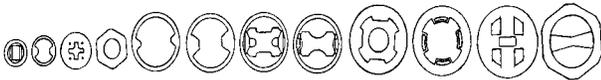



Inspection Mirrors

Part No.	Description
9700	Oval 1 x 2", 8-3/4" Long
9701	Circular 2-1/4" Diameter 10" to 14" Long
9702	Rectangular 2-1/8" x 3-1/2"; 11-1/4" x 15-1/2" Long
9703	Lighted Telescopic Round Mirror 2-3/8" Round



9700



9701



9702



9703





Wright Tool Company offers an impressive selection of

Master Sets for professionals. From our Mega Master

Set with over 560 tools to our smaller Apprentice and

Basic Service Sets, there's something for everyone—even

metric sets. Each set contains quality tools, carefully

selected according to need and coverage.

CONTENTS OF MASTER SETS.



ASME B107.100 – Flat Wrenches

ASME B107.110 – Socket Wrenches

ASME B107.400 – Striking Tools/Hammers

ASME B107.500 – Pliers

ASME B107.510 – Pliers and Shears

ASME B107.600 – Screwdrivers



Mega Fractional Master Set

WRIGHT TOOL
PERFECTING PERFORMANCE



Mega Fractional Master Set—1/4", 3/8", 1/2" & 3/4" Drives

Set No. 101 –
447 Pieces including WT710
Ten Drawer Chest & WT796
Eight Drawer Roller Cabinet

Set No. 102 –
445 Pieces
(Tools Only - Cabinets Not Included)

See Page 13 for photograph.

Part No.	Description	Size	Part No.	Description	Size	Part No.	Description	Size
FLAT WRENCHES			2011	6 Pt. Standard Socket	11/32"	3262	Standard Screwdriver Socket with Bit	3/8"
1012	3/8" Drive Crowfoot Wrench	3/8"	2012	6 Pt. Standard Socket	3/8"	3265	Phillips Screwdriver Socket with Bit	#1
1014	3/8" Drive Crowfoot Wrench	7/16"	2014	6 Pt. Standard Socket	7/16"	3266	Phillips Screwdriver Socket with Bit	#2
1016	3/8" Drive Crowfoot Wrench	1/2"	2016	6 Pt. Standard Socket	1/2"	3267	Phillips Screwdriver Socket with Bit	#3
1018	3/8" Drive Crowfoot Wrench	9/16"	2202	Hex Bit Socket	1/16"	3268	Phillips Screwdriver Socket with Bit	#4
1020	3/8" Drive Crowfoot Wrench	5/8"	2203	Hex Bit Socket	5/64"	3308	Special 8 Pt. Standard Socket	1/4"
1022	3/8" Drive Crowfoot Wrench	11/16"	2204	Hex Bit Socket	3/32"	3310	Special 8 Pt. Standard Socket	5/16"
1024	3/8" Drive Crowfoot Wrench	3/4"	2205	Hex Bit Socket	7/64"	3312	Special 8 Pt. Standard Socket	3/8"
1026	3/8" Drive Crowfoot Wrench	13/16"	2206	Hex Bit Socket	1/8"	3314	Special 8 Pt. Standard Socket	7/16"
1028	3/8" Drive Crowfoot Wrench	7/8"	2207	Hex Bit Socket	9/64"	3316	Special 8 Pt. Standard Socket	1/2"
1032	3/8" Drive Crowfoot Wrench	1"	2208	Hex Bit Socket	5/32"	3318	Special 8 Pt. Standard Socket	9/16"
1108	Combination Wrench, 12 Pt.	1/4"	2210	Hex Bit Socket	3/16"	3320	Special 8 Pt. Standard Socket	5/8"
1108	Combination Wrench, 12 Pt.	5/16"	2212	Hex Bit Socket	7/32"	3322	Special 8 Pt. Standard Socket	11/16"
1112	Combination Wrench, 12 Pt.	3/8"	2214	Hex Bit Socket	1/4"	3324	Special 8 Pt. Standard Socket	3/4"
1114	Combination Wrench, 12 Pt.	7/16"	2218	Hex Bit Socket	5/16"	3326	Special 8 Pt. Standard Socket	13/16"
1116	Combination Wrench, 12 Pt.	1/2"	2308	Special 8 Pt. Standard Socket	1/4"	3328	Special 8 Pt. Standard Socket	7/8"
1118	Combination Wrench, 12 Pt.	9/16"	2310	Special 8 Pt. Standard Socket	5/16"	3402	1-1/2" Extension	
1120	Combination Wrench, 12 Pt.	5/8"	2312	Special 8 Pt. Standard Socket	3/8"	3403	3" Extension	
1122	Combination Wrench, 12 Pt.	11/16"	2506	6 Pt. Deep Socket	3/16"	3405	5" Extension	
1124	Combination Wrench, 12 Pt.	3/4"	2507	6 Pt. Deep Socket	7/32"	3408	8" Extension	
1126	Combination Wrench, 12 Pt.	13/16"	2508	6 Pt. Deep Socket	1/4"	3426	Ratchet	
1128	Combination Wrench, 12 Pt.	7/8"	2509	6 Pt. Deep Socket	9/32"	3435	Flex Handle	
1130	Combination Wrench, 12 Pt.	15/16"	2510	6 Pt. Deep Socket	5/16"	3443	Sliding T	
1132	Combination Wrench, 12 Pt.	1"	2511	6 Pt. Deep Socket	11/32"	3445	Speeder, 14-1/2"	
1134	Combination Wrench, 12 Pt.	1-1/16"	2512	6 Pt. Deep Socket	3/8"	3452	Adapter, 3/8" F x 1/4" M	
1136	Combination Wrench, 12 Pt.	1-1/8"	2514	6 Pt. Deep Socket	7/16"	3454	Adapter, 3/8" F x 1/2" M	
1140	Combination Wrench, 12 Pt.	1-1/4"	2516	6 Pt. Deep Socket	1/2"	3475	Universal	
1242	Combination Wrench, 12 Pt.	1-5/16"	2402	2" Extension		3612	12 Pt. Deep Socket	3/8"
1244	Combination Wrench, 12 Pt.	1-3/8"	2404	4" Extension		3614	12 Pt. Deep Socket	7/16"
1246	Combination Wrench, 12 Pt.	1-7/16"	2406	6" Extension		3616	12 Pt. Deep Socket	1/2"
1248	Combination Wrench, 12 Pt.	1-1/2"	2410	10" Extension		3618	12 Pt. Deep Socket	9/16"
1252	Combination Wrench, 12 Pt.	1-5/8"	2414	14" Extension		3620	12 Pt. Deep Socket	5/8"
1310	Open End Wrench	1/4" x 5/16"	2426	Ratchet		3622	12 Pt. Deep Socket	11/16"
1314	Open End Wrench	3/8" x 7/16"	2435	Flex Handle		3624	12 Pt. Deep Socket	3/4"
1316	Open End Wrench	7/8" x 1/2"	2441	Spinner		3626	12 Pt. Deep Socket	13/16"
1318	Open End Wrench	1/2" x 9/16"	2453	Adapter 1/4" F x 3/8" M		3628	12 Pt. Deep Socket	7/8"
1320	Open End Wrench	9/16" x 5/8"	2475	Universal		3630	12 Pt. Deep Socket	15/16"
1322	Open End Wrench	5/8" x 11/16"	13	Metal Box		3632	12 Pt. Deep Socket	1"
1326	Open End Wrench	3/4" x 13/16"	3/8" DRIVE SOCKETS & ATTACHMENTS			3712	12 Pt. Flex Socket	3/8"
1330	Open End Wrench	7/8" x 15/16"	3108	12 Pt. Standard Socket	1/4"	3714	12 Pt. Flex Socket	7/16"
1332	Open End Wrench	15/16" x 1"	3110	12 Pt. Standard Socket	5/16"	3716	12 Pt. Flex Socket	1/2"
1340	Open End Wrench	1-1/8" x 1-1/4"	3112	12 Pt. Standard Socket	3/8"	3718	12 Pt. Flex Socket	9/16"
1614	Flare Nut Wrench	3/8" x 7/16"	3114	12 Pt. Standard Socket	7/16"	3720	12 Pt. Flex Socket	5/8"
1618	Flare Nut Wrench	1/2" x 9/16"	3116	12 Pt. Standard Socket	1/2"	3722	12 Pt. Flex Socket	11/16"
1622	Flare Nut Wrench	5/8" x 11/16"	3118	12 Pt. Standard Socket	9/16"	3724	12 Pt. Flex Socket	3/4"
51012	12 Pt. Box Wrench - Modified Offset	5/16" x 3/8"	3120	12 Pt. Standard Socket	5/8"	1/2" DRIVE SOCKETS & ATTACHMENTS		
51416	12 Pt. Box Wrench - Modified Offset	7/16" x 1/2"	3122	12 Pt. Standard Socket	11/16"	4112	12 Pt. Standard Socket	3/8"
51820	12 Pt. Box Wrench - Modified Offset	9/16" x 5/8"	3124	12 Pt. Standard Socket	3/4"	4114	12 Pt. Standard Socket	7/16"
52224	12 Pt. Box Wrench - Modified Offset	11/16" x 3/4"	3126	12 Pt. Standard Socket	13/16"	4116	12 Pt. Standard Socket	1/2"
52628	12 Pt. Box Wrench - Modified Offset	13/16" x 7/8"	3128	12 Pt. Standard Socket	7/8"	4118	12 Pt. Standard Socket	9/16"
53032	12 Pt. Box Wrench - Modified Offset	15/16" x 1"	3130	12 Pt. Standard Socket	15/16"	4120	12 Pt. Standard Socket	5/8"
53436	12 Pt. Box Wrench - Modified Offset	1-1/16" x 1-1/8"	3132	12 Pt. Standard Socket	1"	4122	12 Pt. Standard Socket	11/16"
1/4" DRIVE SOCKETS & ATTACHMENTS			3204	Hex Bit Socket	1/8"	4124	12 Pt. Standard Socket	3/4"
2005	6 Pt. Standard Socket	5/32"	3205	Hex Bit Socket	5/32"	4126	12 Pt. Standard Socket	13/16"
2006	6 Pt. Standard Socket	3/16"	3206	Hex Bit Socket	3/16"	4128	12 Pt. Standard Socket	7/8"
2007	6 Pt. Standard Socket	7/32"	3207	Hex Bit Socket	7/32"	4130	12 Pt. Standard Socket	15/16"
2008	6 Pt. Standard Socket	1/4"	3208	Hex Bit Socket	1/4"	4132	12 Pt. Standard Socket	1"
2009	6 Pt. Standard Socket	9/32"	3210	Hex Bit Socket	5/16"	4134	12 Pt. Standard Socket	1-1/16"
2010	6 Pt. Standard Socket	5/16"	3212	Hex Bit Socket	3/8"	4136	12 Pt. Standard Socket	1-1/8"
			3260	Standard Screwdriver Socket with Bit	1/4"	4138	12 Pt. Standard Socket	1-3/16"





Part No.	Description	Size	Part No.	Description	Size	Part No.	Description
4140	12 Pt. Standard Socket	1-1/4"	6164	12 Pt. Standard Socket	2"	9281	6mm Ribs, 5/16" Hex x 1-1/8" Long
4142	12 Pt. Standard Socket	1-5/16"	6166	12 Pt. Standard Socket	2-1/16"	9282	Torx T-30, 5/16" Hex x 1-1/8" Long
4144	12 Pt. Standard Socket	1-3/8"	6168	12 Pt. Standard Socket	2-1/8"	9283	Torx T-40, 5/16" Hex x 1-1/8" Long
4146	12 Pt. Standard Socket	1-7/16"	6170	12 Pt. Standard Socket	2-3/16"	9284	Torx T-45, 5/16" Hex x 1-1/8" Long
4148	12 Pt. Standard Socket	1-1/2"	6172	12 Pt. Standard Socket	2-1/4"	9285	Torx T-47, 5/16" Hex x 1-1/8" Long
4208	Hex Bit Socket	1/4"	6176	12 Pt. Standard Socket	2-3/8"	9286	Torx T-50, 5/16" Hex x 1-1/8" Long
4210	Hex Bit Socket	5/16"	6400	Ratchet		9290	5/16" Hex x 3/8" Sq. Dr. Bit Holder
4212	Hex Bit Socket	3/8"	6403	3-1/2" Extension		9424	Ratchet Box Wrench, 12 Pt. Offset Rev., 1/4" x 5/16"
4214	Hex Bit Socket	7/16"	6408	8" Extension		9425	Ratchet Box Wrench, 12 Pt. Offset Rev., 3/8" x 7/16"
4216	Hex Bit Socket	1/2"	6416	16" Extension		9426	Ratchet Box Wrench, 12 Pt. Offset Rev., 1/2" x 9/16"
4218	Hex Bit Socket	9/16"	6435	Flex Handle		9427	Ratchet Box Wrench, 12 Pt. Offset Rev., 5/8" x 11/16"
4220	Hex Bit Socket	5/8"	6443	Sliding T		9428	Ratchet Box Wrench, 12 Pt. Offset Rev., 3/4" x 7/8"
4312	Special 8 Pt. Standard Socket	3/8"	6475	Universal		9471	Stripper/Crimper/Cutter 10-20 AWG
4314	Special 8 Pt. Standard Socket	7/16"	6900	Impact Adapter, 3/4" F x 1/2" M		9481	Gasket Scraper, Blade Width 1-1/2"
4316	Special 8 Pt. Standard Socket	1/2"	6901	Impact Adapter, 3/4" F x 1" M		9488	Flexible Scraper Blade, 1-1/4"
4318	Special 8 Pt. Standard Socket	9/16"				9506	Tape Measure, 12' x 3/4"
4320	Special 8 Pt. Standard Socket	5/8"				9520	Hacksaw
4322	Special 8 Pt. Standard Socket	11/16"	787	Miniature Combination Wrench Set, 10 Pieces		9521	Carbon Steel Blades - 10 Pieces
4324	Special 8 Pt. Standard Socket	3/4"	9010	Universal Wheel Hub Puller		9526	Utility Knife
4326	Special 8 Pt. Standard Socket	13/16"	9020	Stud Remover		9530	Feeler Gauge
4328	Special 8 Pt. Standard Socket	7/8"	9022	Rubber Mallet, 2-5/8" Head Dia. x 16-3/4" Length		9535	Magnetic Pick-up Tool
4330	Special 8 Pt. Standard Socket	15/16"	9023	Dead Blow Hammer with Super Grip, 1 Lb.		9575	Pinch Bar, 1/2" x 4"
4332	Special 8 Pt. Standard Socket	1"	9029	Brass Hammer with Super Grip, 2.5 Lbs.		9577	Pinch Bar, 3/4" x 20"
4334	Special 8 Pt. Standard Socket	1-1/16"	9032	Soft Face Hammer, 37 oz., 1.75"		9630	Spanner Wrench, Adj. Hook, Black 3/4" to 2", 1/8" Hook
4336	Special 8 Pt. Standard Socket	1-1/8"	9040	Ball Peen Hammer, Fiberglass Handle, 8 Oz.		9632	Spanner Wrench, Adj. Hook, Black 2" to 4-3/4", 3/16" Hook
4340	Special 8 Pt. Standard Socket	1-1/4"	9042	Ball Peen Hammer, Fiberglass Handle, 16 Oz.		9666	Master Punch & Chisel Kit - 24 Pieces
4402	2" Extension		9045	Ball Peen Hammer, Fiberglass Handle, 32 Oz.		9685	Punch & Chisel Holder
4405	5" Extension		90404B	Deep Throat Forged Steel C-Clamp, Black Oxide, 4", 2 each		9702	Rectangular Inspection Mirror, 2-1/8" x 3-1/2", 11-1/2" x 15-1/2" Long
4410	10" Extension		9101	Phillips Screwdriver #2 - 1-1/2"		9AC08	Adjustable Wrench, 8"
4420	20" Extension		9104	Phillips Screwdriver #1 - 3"		9AC10	Adjustable Wrench, 10"
4425	Ratchet - Long Handle		9105	Phillips Screwdriver #2 - 4"		9AC12	Adjustable Wrench, 12"
4426	Ratchet		9106	Phillips Screwdriver #3 - 6"		9AC15	Adjustable Wrench, 15"
4435	Flex Handle		9109	Phillips Screwdriver #4 - 8"		9C317	Long Nose Pliers w/Side Cutter, 7-1/2"
4443	Sliding T		9113	Cabinet Tip Screwdriver, 1/8" - 5"		9C318	Long Nose Pliers w/Side Cutter, 8"
4445	Speeder		9114	Cabinet Tip Screwdriver, 3/16" - 3"		9C326	Long Nose Pliers w/Side Cutter, 6"
4453	Adapter, 1/2" F x 3/8" M		9115	Cabinet Tip Screwdriver, 3/16" - 4"		9C348	Linesman Pliers, Round Nose, 8"
4475	Universal		9116	Cabinet Tip Screwdriver, 3/16" - 6"		9C357	Pliers, End Cutting
4478	Micro-Adjustable Torque Wrench, 30-250 Ft. Lbs.		9117	Cabinet Tip Screwdriver, 3/16" - 8"		9C386	Long Nose Pliers, Curved w/Serrated Jaws, 6"
4612	12 Pt. Deep Socket	3/8"	9122	Round Shank Screwdriver, 1/4" Stubby		9C424	Tongue and Groove Pliers, 4-1/2"
4614	12 Pt. Deep Socket	7/16"	9123	Round Shank Screwdriver, 1/4" - 4"		9C430	Tongue and Groove Pliers, 10"
4616	12 Pt. Deep Socket	1/2"	9124	Round Shank Screwdriver, 1/4" - 6"		9C440	Tongue and Groove Pliers, 12"
4618	12 Pt. Deep Socket	9/16"	9125	Round Shank Screwdriver, 5/16" - 6"		9C447	Cutting Pliers, Curved Diagonal, Box Joint, 7-3/4"
4620	12 Pt. Deep Socket	5/8"	9126	Round Shank Screwdriver, 3/8" - 8"		9C460	Tongue and Groove Pliers, 16"
4622	12 Pt. Deep Socket	11/16"	9132	Square Shank Screwdriver, 1/4" - 4"		9C718	Duck Bill Needle Nose, 7"
4624	12 Pt. Deep Socket	3/4"	9134	Square Shank Screwdriver, 5/16" - 6"		9G95202	Screw Extractor Set - 5 Pieces
4626	12 Pt. Deep Socket	13/16"	9135	Square Shank Standard Tip, 3/8" - 8"		9H1234	Retaining Ring Pliers w/Replaceable Tips
4628	12 Pt. Deep Socket	7/8"	9136	Square Shank Screwdriver 3/8" - 10"		9M424	Rolling Head Pry Bar (Lady Slipper), 7/16" x 12"
4630	12 Pt. Deep Socket	15/16"	9137	Square Shank Screwdriver 3/8" - 12"		9M426	Rolling Head Pry Bar (Lady Slipper), 9/16" x 16"
4632	12 Pt. Deep Socket	1"	9181	Two-in-One Flip Screwdriver w/Pocket Clip #1 Phillips and 5/32" Slotted Blades. OAL 4-3/4"		9V10WR	Curved Jaw Locking Pliers, w/Wire Cutter, 10"
4634	12 Pt. Deep Socket	1-1/16"	9184	Offset Screwdriver, 5/16"		9V20R	Locking Chain Clamp Ridgid Pipe Wrench, 11"
4636	12 Pt. Deep Socket	1-1/8"	9186	Offset Screwdriver, #1 x #2		9P6716S	Aviation Snips, Cuts Straight, Yellow, 10"
4638	12 Pt. Deep Socket	1-3/16"	9220	Hollow Shaft Nut Driver, 3/16"		9V6LN	Long Nose Locking Pliers, w/Wire Cutter, 6"
4640	12 Pt. Deep Socket	1-1/4"	9221	Hollow Shaft Nut Driver, 7/32"		9V7R	Straight Jaw Locking Pliers
4642	12 Pt. Deep Socket	1-5/16"	9222	Hollow Shaft Nut Driver, 1/4"		9E98010	Hex Key Set - 13 Pieces
4644	12 Pt. Deep Socket	1-3/8"	9223	Hollow Shaft Nut Driver, 9/32"			
4646	12 Pt. Deep Socket	1-7/16"	9224	Hollow Shaft Nut Driver, 5/16"			
4648	12 Pt. Deep Socket	1-1/2"	9225	Hollow Shaft Nut Driver, 11/32"			
			9226	Hollow Shaft Nut Driver, 3/8"			
			9227	Hollow Shaft Nut Driver, 7/16"			
			9228	Hollow Shaft Nut Driver, 1/2"			
			9229	Hollow Shaft Nut Driver, 9/16"			
			9230	Hollow Shaft Nut Driver, 5/8"			
			9250	E-6 Torx Socket, 1/4" Dr. x 1" Long			
			9251	E-7 Torx Socket, 1/4" Dr. x 1" Long			
			9252	E-8 Torx Socket, 1/4" Dr. x 1" Long			
			9255	E-10 Torx Socket, 3/8" Dr. x 1-1/4" Long			
			9256	E-12 Torx Socket, 3/8" Dr. x 1-1/4" Long			
			9257	E-14 Torx Socket, 3/8" Dr. x 1-1/4" Long			
			9258	E-16 Torx Socket, 3/8" Dr. x 1-1/4" Long			
			9271	Torx T-8, 1/4" Hex x 1" Long			
			9272	Torx T-10, 1/4" Hex x 1" Long			
			9273	Torx T-15, 1/4" Hex x 1" Long			
			9274	Torx T-20, 1/4" Hex x 1" Long			
			9275	Torx T-25, 1/4" Hex x 1" Long			
			9276	Torx T-27, 1/4" Hex x 1" Long			
			9277	Torx T-30, 1/4" Hex x 1" Long			
			9280	1/4" Hex x 1/4" Square Drive Adapter			

3/4" DRIVE SOCKETS & ATTACHMENTS

6124	12 Pt. Standard Socket	3/4"
6126	12 Pt. Standard Socket	13/16"
6128	12 Pt. Standard Socket	7/8"
6130	12 Pt. Standard Socket	15/16"
6132	12 Pt. Standard Socket	1"
6134	12 Pt. Standard Socket	1-1/16"
6136	12 Pt. Standard Socket	1-1/8"
6138	12 Pt. Standard Socket	1-3/16"
6140	12 Pt. Standard Socket	1-1/4"
6142	12 Pt. Standard Socket	1-5/16"
6144	12 Pt. Standard Socket	1-3/8"
6146	12 Pt. Standard Socket	1-7/16"
6148	12 Pt. Standard Socket	1-1/2"
6150	12 Pt. Standard Socket	1-9/16"
6152	12 Pt. Standard Socket	1-5/8"
6154	12 Pt. Standard Socket	1-11/16"
6156	12 Pt. Standard Socket	1-3/4"
6158	12 Pt. Standard Socket	1-13/16"
6160	12 Pt. Standard Socket	1-7/8"

Master Set Contents

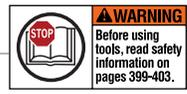



Mega Fractional/Metric Master Set—1/4", 3/8", 1/2" & 3/4" Drives

Set No. 105 –

**561 Pieces including WT861 Nine Drawer
42" Top Chest & WT854 Fifteen Drawer
42" Roller Cabinet**

Set No. 107 –

**559 Pieces
(Tools Only - Cabinets Not Included)**

See Page 14 for photograph.

Part No.	Description	Size	Part No.	Description	Size	Part No.	Description	Size		
FLAT WRENCHES										
10-10mm	3/8" Drive Metric Crowfoot Wrench	10mm	1140	Combination Wrench, 12 Pt.	1-1/4"	20-11mm	6 Pt. Standard Metric Socket	11mm		
10-11mm	3/8" Drive Metric Crowfoot Wrench	11mm	1142	Combination Wrench, 12 Pt.	1-5/16"	20-12mm	6 Pt. Standard Metric Socket	12mm		
10-12mm	3/8" Drive Metric Crowfoot Wrench	12mm	1144	Combination Wrench, 12 Pt.	1-3/8"	20-13mm	6 Pt. Standard Metric Socket	13mm		
10-13mm	3/8" Drive Metric Crowfoot Wrench	13mm	1146	Combination Wrench, 12 Pt.	1-7/16"	20-14mm	6 Pt. Standard Metric Socket	14mm		
10-14mm	3/8" Drive Metric Crowfoot Wrench	14mm	1148	Combination Wrench, 12 Pt.	1-1/2"	2006	6 Pt. Standard Socket	3/16"		
10-15mm	3/8" Drive Metric Crowfoot Wrench	15mm	13-0607mm	Full Polish Metric Open End Wrench	6mm x 7mm	2007	6 Pt. Standard Socket	7/32"		
10-16mm	3/8" Drive Metric Crowfoot Wrench	16mm	13-0809mm	Full Polish Metric Open End Wrench	8mm x 9mm	2008	6 Pt. Standard Socket	1/4"		
10-17mm	3/8" Drive Metric Crowfoot Wrench	17mm	13-1011mm	Full Polish Metric Open End Wrench	10mm x 11mm	2009	6 Pt. Standard Socket	9/32"		
10-18mm	3/8" Drive Metric Crowfoot Wrench	18mm	13-1213mm	Full Polish Metric Open End Wrench	12mm x 13mm	2010	6 Pt. Standard Socket	5/16"		
10-19mm	3/8" Drive Metric Crowfoot Wrench	19mm	13-1415mm	Full Polish Metric Open End Wrench	14mm x 15mm	2011	6 Pt. Standard Socket	11/32"		
1012	3/8" Drive Crowfoot Wrench	3/8"	13-1617mm	Full Polish Metric Open End Wrench	16mm x 17mm	2012	6 Pt. Standard Socket	3/8"		
1014	3/8" Drive Crowfoot Wrench	7/16"	13-1819mm	Full Polish Metric Open End Wrench	18mm x 19mm	2014	6 Pt. Standard Socket	7/16"		
1016	3/8" Drive Crowfoot Wrench	1/2"	13-2022mm	Full Polish Metric Open End Wrench	20mm x 22mm	2016	6 Pt. Standard Socket	1/2"		
1018	3/8" Drive Crowfoot Wrench	9/16"	13-2123mm	Full Polish Metric Open End Wrench	21mm x 23mm	2118	12 Pt. Standard Socket	9/16"		
1020	3/8" Drive Crowfoot Wrench	5/8"	13-2426mm	Full Polish Metric Open End Wrench	24mm x 26mm	2202	Hex Bit Socket	1/16"		
1022	3/8" Drive Crowfoot Wrench	11/16"	1310	Open End Wrench	1/4" x 5/16"	2203	Hex Bit Socket	5/64"		
1024	3/8" Drive Crowfoot Wrench	3/4"	1312	Open End Wrench	3/8" x 5/16"	2204	Hex Bit Socket	3/32"		
1026	3/8" Drive Crowfoot Wrench	13/16"	1316	Open End Wrench	7/16" x 1/2"	2205	Hex Bit Socket	7/64"		
1028	3/8" Drive Crowfoot Wrench	7/8"	1318	Open End Wrench	1/2" x 9/16"	2206	Hex Bit Socket	1/8"		
1040	Combination Open End Flare Nut Wrench	3/8"	1320	Open End Wrench	9/16" x 5/8"	2207	Hex Bit Socket	9/64"		
1042	Combination Open End Flare Nut Wrench	7/16"	1324	Open End Wrench	5/8" x 3/4"	2208	Hex Bit Socket	5/32"		
1044	Combination Open End Flare Nut Wrench	1/2"	1325	Open End Wrench	11/16" x 3/4"	2210	Hex Bit Socket	3/16"		
1046	Combination Open End Flare Nut Wrench	9/16"	1329	Open End Wrench	13/16" x 7/8"	2212	Hex Bit Socket	7/32"		
1048	Combination Open End Flare Nut Wrench	5/8"	1332	Open End Wrench	15/16" x 1"	2214	Hex Bit Socket	1/4"		
1050	Combination Open End Flare Nut Wrench	11/16"	1336	Open End Wrench	1-1/16" x 1-1/8"	2218	Hex Bit Socket	5/16"		
1052	Combination Open End Flare Nut Wrench	3/4"	16-11mm	Metric Flare Nut Wrench, 6 Pt.	9mm x 11mm	2260	Standard Screwdriver Socket with Bit (9204)	3/16"		
11-07mm	Metric Combination Wrench, 12 Pt.	7mm	16-12mm	Metric Flare Nut Wrench, 6 Pt.	10mm x 12mm	2261	Standard Screwdriver Socket with Bit (9205)	1/4"		
11-08mm	Metric Combination Wrench, 12 Pt.	8mm	16-14mm	Metric Flare Nut Wrench, 6 Pt.	13mm x 14mm	2263	Standard Screwdriver Socket with Bit	23/64"		
11-09mm	Metric Combination Wrench, 12 Pt.	9mm	16-17mm	Metric Flare Nut Wrench, 6 Pt.	15mm x 17mm	2265	Phillips Screwdriver Socket with Bit (9200)	#1		
11-10mm	Metric Combination Wrench, 12 Pt.	10mm	16-21mm	Metric Flare Nut Wrench, 6 Pt.	19mm x 21mm	2267	Phillips Screwdriver Socket with Bit (9201)	#2		
11-11mm	Metric Combination Wrench, 12 Pt.	11mm	1642	Ratcheting Flare Nut Wrench	3/8"	2308	Special 8 Pt. Standard Socket	1/4"		
11-12mm	Metric Combination Wrench, 12 Pt.	12mm	1644	Ratcheting Flare Nut Wrench	7/16"	2310	Special 8 Pt. Standard Socket	5/16"		
11-13mm	Metric Combination Wrench, 12 Pt.	13mm	1646	Ratcheting Flare Nut Wrench	1/2"	2312	Special 8 Pt. Standard Socket	3/8"		
11-14mm	Metric Combination Wrench, 12 Pt.	14mm	1648	Ratcheting Flare Nut Wrench	9/16"	2402	2" Extension			
11-15mm	Metric Combination Wrench, 12 Pt.	15mm	1650	Ratcheting Flare Nut Wrench	5/8"	2404	4" Extension			
11-16mm	Metric Combination Wrench, 12 Pt.	16mm	1652	Ratcheting Flare Nut Wrench	11/16"	2406	6" Extension			
11-17mm	Metric Combination Wrench, 12 Pt.	17mm	1654	Ratcheting Flare Nut Wrench	3/4"	2435	Flex Handle			
11-18mm	Metric Combination Wrench, 12 Pt.	18mm	51012	12 Pt. Box Wrench - Modified Offset	5/16" x 3/8"	2442	Spinner w/female end			
11-19mm	Metric Combination Wrench, 12 Pt.	19mm	51416	12 Pt. Box Wrench - Modified Offset	7/16" x 1/2"	2445	Speed Handle			
11-20mm	Metric Combination Wrench, 12 Pt.	20mm	51820	12 Pt. Box Wrench - Modified Offset	9/16" x 5/8"	2475	Universal Joint			
11-21mm	Metric Combination Wrench, 12 Pt.	21mm	52224	12 Pt. Box Wrench - Modified Offset	11/16" x 3/4"	2492	Ratchet			
11-22mm	Metric Combination Wrench, 12 Pt.	22mm	52628	12 Pt. Box Wrench - Modified Offset	13/16" x 7/8"	25-04mm	6 Pt. Deep Metric Socket	4mm		
11-23mm	Metric Combination Wrench, 12 Pt.	23mm	53032	12 Pt. Box Wrench - Modified Offset	15/16" x 1"	25-05mm	6 Pt. Deep Metric Socket	5mm		
11-24mm	Metric Combination Wrench, 12 Pt.	24mm	53436	12 Pt. Box Wrench - Modified Offset	1-1/16" x 1-1/8"	25-06mm	6 Pt. Deep Metric Socket	6mm		
1110	Combination Wrench, 12 Pt.	5/16"	50810mm	Metric 12 Pt. Box Wrench - Modified Offset	8mm x 10mm	25-07mm	6 Pt. Deep Metric Socket	7mm		
1112	Combination Wrench, 12 Pt.	3/8"	51011mm	Metric 12 Pt. Box Wrench - Modified Offset	10mm x 11mm	25-08mm	6 Pt. Deep Metric Socket	8mm		
1114	Combination Wrench, 12 Pt.	7/16"	51213mm	Metric 12 Pt. Box Wrench - Modified Offset	12mm x 13mm	25-09mm	6 Pt. Deep Metric Socket	9mm		
1116	Combination Wrench, 12 Pt.	1/2"	51415mm	Metric 12 Pt. Box Wrench - Modified Offset	14mm x 15mm	25-10mm	6 Pt. Deep Metric Socket	10mm		
1118	Combination Wrench, 12 Pt.	9/16"	51618mm	Metric 12 Pt. Box Wrench - Modified Offset	16mm x 18mm	25-11mm	6 Pt. Deep Metric Socket	11mm		
1120	Combination Wrench, 12 Pt.	5/8"	51719mm	Metric 12 Pt. Box Wrench - Modified Offset	17mm x 19mm	25-12mm	6 Pt. Deep Metric Socket	12mm		
1122	Combination Wrench, 12 Pt.	11/16"	1/4" DRIVE SOCKETS & ATTACHMENTS					25-13mm	6 Pt. Deep Metric Socket	13mm
1124	Combination Wrench, 12 Pt.	3/4"	20-04mm	6 Pt. Standard Metric Socket	4mm	2506	6 Pt. Deep Socket	3/16"		
1126	Combination Wrench, 12 Pt.	13/16"	20-05mm	6 Pt. Standard Metric Socket	5mm	2507	6 Pt. Deep Socket	7/32"		
1128	Combination Wrench, 12 Pt.	7/8"	20-5.5mm	6 Pt. Standard Metric Socket	5.5mm	2508	6 Pt. Deep Socket	1/4"		
1130	Combination Wrench, 12 Pt.	15/16"	20-06mm	6 Pt. Standard Metric Socket	6mm	2509	6 Pt. Deep Socket	9/32"		
1132	Combination Wrench, 12 Pt.	1"	20-07mm	6 Pt. Standard Metric Socket	7mm	2510	6 Pt. Deep Socket	5/16"		
1134	Combination Wrench, 12 Pt.	1-1/16"	20-08mm	6 Pt. Standard Metric Socket	8mm	2511	6 Pt. Deep Socket	11/32"		
1136	Combination Wrench, 12 Pt.	1-1/8"	20-09mm	6 Pt. Standard Metric Socket	9mm	2512	6 Pt. Deep Socket	3/8"		
			20-10mm	6 Pt. Standard Metric Socket	10mm	2514	6 Pt. Deep Socket	7/16"		
						2516	6 Pt. Deep Socket	1/2"		



Mega Fractional/Metric Master Set

WRIGHT TOOL
PERFECTING PERFORMANCE



Part No.	Description	Part No.	Description
9105	Phillips Screwdriver #2 - 4"	9AC06	Adjustable Wrench, 6"
9106	Phillips Screwdriver #3 - 6"	9AC08	Adjustable Wrench, 8"
9107	Phillips Screwdriver #1 - 6"	9AC10	Adjustable Wrench, 10"
9108	Phillips Screwdriver #2 - 6"	9AC12	Adjustable Wrench, 12"
9109	Phillips Screwdriver #4 - 8"	9AC15	Adjustable Wrench, 15"
9112	Cabinet Tip Screwdriver, 1/8" - 3"	9C317	Long Nose Pliers w/Side Cutter, 7-1/2"
9113	Cabinet Tip Screwdriver, 1/8" - 5"	9C326	Long Nose Pliers w/Side Cutter, 6"
9114	Cabinet Tip Screwdriver, 3/16" - 3"	9C337	Pliers, Lap Joint
9115	Cabinet Tip Screwdriver, 3/16" - 4"	9C348	Linesman Pliers, Round Nose, 8"
9117	Cabinet Tip Screwdriver, 3/16" - 8"	9C357	Pliers, End Cutting
9122	Round Shank Screwdriver, 1/4" - 1-1/2"	9C386	Long Nose Pliers, Curved w/Serrated Jaws, 6"
9132	Square Shank Screwdriver, 1/4" - 4"	9C424	Tongue and Groove Pliers, 4-1/2"
9133	Square Shank Screwdriver, 1/4" - 6"	9C426	Tongue and Groove Pliers, 6-1/2"
9134	Square Shank Screwdriver, 5/16" - 6"	9C430	Tongue and Groove Pliers, 10"
9135	Square Shank Standard Tip, 3/8" - 8"	9C436	Pliers, Box Joint
9137	Square Standard Tip 3/8" - 12"	9C460	Tongue and Groove Pliers, 16"
9181	Two-in-One Flip Screwdriver w/Pocket Clip #1 Phillips and 5/32" Slotted Blades. OAL 4-3/4"	9C526	Slip Joint Pliers Wire Cutting Shear, 6"
9184	Offset Screwdriver, 5/16"	9C537	Slip Joint Pliers, 7"
9186	Offset Screwdriver, #1 x #2	9C718	Duck Bill Needle Nose, 7"
9220	Hollow Shaft Nut Driver, 3/16"	9E10113	13-Piece Hex Torx Key Set
9221	Hollow Shaft Nut Driver, 7/32"	9E10609	9-Piece Hex Torx Key Set
9222	Hollow Shaft Nut Driver, 1/4"	9G95202	Screw Extractor Set - 5 Pieces
9223	Hollow Shaft Nut Driver, 9/32"	9H1265K	Snap Ring Plier Set - 3 Pieces
9224	Hollow Shaft Nut Driver, 5/16"	9M42007	Dominator Carbon Scraper, 1-1/2"
9225	Hollow Shaft Nut Driver, 11/32"	9M472	Pinch Bar, 3/4" x 24"
9226	Hollow Shaft Nut Driver, 3/8"	9M482	Rolling Head Pry Bar, 1/2" x 16"
9227	Hollow Shaft Nut Driver, 7/16"	9M483	Rolling Head Pry Bar, 5/8" x 18"
9228	Hollow Shaft Nut Driver, 1/2"	9P127S	Metal Cutting Snips - Straight, 7"
9229	Hollow Shaft Nut Driver, 9/16"	9P6716L	Aviation Snips, Cuts Left, Red, 10"
9230	Hollow Shaft Nut Driver, 5/8"	9R31010	Ridgid Pipe Wrench, 10"
9381	Ratcheting Box Wrench, 6 Pt., 1/4" x 5/16"	9R31020	Ridgid Pipe Wrench, 14"
9382	Ratcheting Box Wrench, 6 Pt., 3/8" x 7/16"	9R31025	Ridgid Pipe Wrench, 18"
9383	Ratcheting Box Wrench, 6 Pt., 1/2" x 9/16"	9V10CR	Curved Jaw Locking Pliers, 10"
9384	Ratcheting Box Wrench, 12 Pt., 5/8" x 11/16"	9V20R	Locking Chain Clamp Ridgid Pipe Wrench, 11"
9386	Ratcheting Box Wrench, 12 Pt., 3/4" x 7/16"	9V6LN	Long Nose Locking Pliers, 6"
9416	Metric Ratcheting Box Wrench, 6 Pt. Rev., 7mm x 8mm	9V7R	Straight Jaw Locking Pliers, 7"
9417	Metric Ratcheting Box Wrench, 6 Pt. Rev., 9mm x 10mm	WT1315	Roller Cabinet, 14 Drawers, 42"
9418	Metric Ratcheting Box Wrench, 6 Pt., 11mm x 12mm	WT1320	Top Chest, 11 Drawers, 42"
9419	Metric Ratcheting Box Wrench, 6 Pt., 13mm x 14mm		
9421	Metric Ratcheting Box Wrench, 12 Pt., 15mm x 17mm		
9471	Stripper/Crimper/Cutter, 10-20 AWG		
9488	Flexible Scraper Blade, 1-1/4"		
9507	Tape Measure, 12' x 3/4"		
9523	Hacksaw		
9526	Utility Knife		
9535	Magnetic Pick-up Tool		
9538	Center Punch, 3/8" x 5"		
9539	Center Punch, 1/2" x 6"		
9553	Starter Punch, 1/8" x 5"		
9555	Starter Punch, 5/32" x 6"		
9556	Starter Punch, 3/16" x 5"		
9557	Starter Punch, 1/4" x 5"		
9558	Starter Punch, 5/16" x 6"		
9563	Prick Punch, 5/16" x 4-1/4"		
9576	Punch Bar, 5/8" x 18"		
9581	Line-Up Punch, 1/8" x 8"		
9583	Line-Up Punch, 3/16" x 10"		
9584	Line-Up Punch, 1/4" x 12"		
9591	Pin Punch, 3/32" x 4-1/2"		
9592	Pin Punch, 1/8" x 4-3/4"		
9593	Pin Punch, 5/32" x 5"		
9594	Pin Punch, 3/16" x 5-1/4"		
9595	Pin Punch, 7/32" x 5-1/2"		
9596	Pin Punch, 1/4" x 5-3/4"		
9600	Cold Chisel, 1/4" x 5"		
9601	Cold Chisel, 5/16" x 5"		
9602	Cold Chisel, 3/8" x 5-1/2"		
9603	Cold Chisel, 1/2" x 6"		
9604	Cold Chisel, 5/8" x 6-1/2"		
9605	Cold Chisel, 3/4" x 7"		
9606	Cold Chisel, 7/8" x 7-1/2"		
9607	Cold Chisel, 1" x 8"		
9609	Cold Chisel, 3/4" x 12"		
9685	Punch & Chisel Holder		
9702	Rectangular Inspection Mirror, 2-1/8" x 3-1/2", 11-1/2" x 15-1/2" Long		



WARNING
Wear safety goggles user and bystander.



WARNING
Before using tools, read safety information on pages 399-403.



WARNING
Comfort or plastic grips do not protect against electric shock.

www.wrighttool.com





Master Fractional/Metric Set—1/4", 3/8", 1/2" & 3/4" Drives

Set No. 112 –
283 Pieces including WT814 Twelve
Drawer Chest & WT896 Eleven Drawer
Roller Cabinet

Set No. 113 –
281 Pieces
(Tools Only - Cabinets Not Included)

See Page 15 for photograph.

Part No.	Description	Size	Part No.	Description	Size	Part No.	Description	Size
FLAT WRENCHES								
1012	3/8" Drive Crowfoot Wrench	3/8"	2509	6 Pt. Deep Socket	9/32"	3405	5" Extension	
1014	3/8" Drive Crowfoot Wrench	7/16"	2510	6 Pt. Deep Socket	5/16"	3412	12" Extension	
1016	3/8" Drive Crowfoot Wrench	1/2"	2511	6 Pt. Deep Socket	11/32"	3426	Ratchet, 7" Contour Grip	
1018	3/8" Drive Crowfoot Wrench	9/16"	2512	6 Pt. Deep Socket	3/8"	3427	Flex Head Ratchet, 9-11/16" Knurled Steel Grip	
1020	3/8" Drive Crowfoot Wrench	5/8"	2514	6 Pt. Deep Socket	7/16"	3435	Flex Handle	
1022	3/8" Drive Crowfoot Wrench	11/16"	2516	6 Pt. Deep Socket	1/2"	3443	Sliding T	
1024	3/8" Drive Crowfoot Wrench	3/4"	2402	2" Extension		3445	Speeder, 14-1/2"	
1026	3/8" Drive Crowfoot Wrench	13/16"	2406	6" Extension		3452	Adapter, 3/8" F x 1/4" M	
1028	3/8" Drive Crowfoot Wrench	7/8"	2426	Ratchet, 4-3/4" Contour Handle		3454	Adapter, 3/8" F x 1/2" M	
1032	3/8" Drive Crowfoot Wrench	1"	2430	Bar		3475	Universal	
11-07mm	Metric Combination Wrench, 12 Pt.	7mm	2435	Flex Handle		3508	6 Pt. Deep Socket	1/4"
11-08mm	Metric Combination Wrench, 12 Pt.	8mm	2441	Spinner		3510	6 Pt. Deep Socket	5/16"
11-09mm	Metric Combination Wrench, 12 Pt.	9mm	3/8" DRIVE SOCKETS & ATTACHMENTS			3512	6 Pt. Deep Socket	3/8"
11-10mm	Metric Combination Wrench, 12 Pt.	10mm	3008	6 Pt. Standard Socket	1/4"	3514	6 Pt. Deep Socket	7/16"
11-11mm	Metric Combination Wrench, 12 Pt.	11mm	3010	6 Pt. Standard Socket	5/16"	3516	6 Pt. Deep Socket	1/2"
11-12mm	Metric Combination Wrench, 12 Pt.	12mm	3012	6 Pt. Standard Socket	3/8"	3518	6 Pt. Deep Socket	9/16"
11-13mm	Metric Combination Wrench, 12 Pt.	13mm	3014	6 Pt. Standard Socket	7/16"	3520	6 Pt. Deep Socket	5/8"
11-14mm	Metric Combination Wrench, 12 Pt.	14mm	3016	6 Pt. Standard Socket	1/2"	3522	6 Pt. Deep Socket	11/16"
11-15mm	Metric Combination Wrench, 12 Pt.	15mm	3018	6 Pt. Standard Socket	9/16"	3524	6 Pt. Deep Socket	3/4"
11-16mm	Metric Combination Wrench, 12 Pt.	16mm	30-06mm	6 Pt. Standard Metric Socket	6mm	3526	6 Pt. Deep Socket	13/16"
11-17mm	Metric Combination Wrench, 12 Pt.	17mm	30-07mm	6 Pt. Standard Metric Socket	7mm	3528	6 Pt. Deep Socket	7/8"
11-18mm	Metric Combination Wrench, 12 Pt.	18mm	30-08mm	6 Pt. Standard Metric Socket	8mm	3530	6 Pt. Deep Socket	15/16"
11-19mm	Metric Combination Wrench, 12 Pt.	19mm	30-09mm	6 Pt. Standard Metric Socket	9mm	3532	6 Pt. Deep Socket	1"
1108	Combination Wrench, 12 Pt.	1/4"	30-10mm	6 Pt. Standard Metric Socket	10mm	35-06mm	6 Pt. Deep Metric Socket	6mm
1110	Combination Wrench, 12 Pt.	5/16"	30-11mm	6 Pt. Standard Metric Socket	11mm	35-07mm	6 Pt. Deep Metric Socket	7mm
1112	Combination Wrench, 12 Pt.	3/8"	30-12mm	6 Pt. Standard Metric Socket	12mm	35-08mm	6 Pt. Deep Metric Socket	8mm
1114	Combination Wrench, 12 Pt.	7/16"	30-13mm	6 Pt. Standard Metric Socket	13mm	35-09mm	6 Pt. Deep Metric Socket	9mm
1116	Combination Wrench, 12 Pt.	1/2"	30-14mm	6 Pt. Standard Metric Socket	14mm	35-10mm	6 Pt. Deep Metric Socket	10mm
1118	Combination Wrench, 12 Pt.	9/16"	30-15mm	6 Pt. Standard Metric Socket	15mm	35-11mm	6 Pt. Deep Metric Socket	11mm
1120	Combination Wrench, 12 Pt.	5/8"	30-16mm	6 Pt. Standard Metric Socket	16mm	35-12mm	6 Pt. Deep Metric Socket	12mm
1122	Combination Wrench, 12 Pt.	11/16"	30-17mm	6 Pt. Standard Metric Socket	17mm	35-13mm	6 Pt. Deep Metric Socket	13mm
1124	Combination Wrench, 12 Pt.	3/4"	30-18mm	6 Pt. Standard Metric Socket	18mm	35-14mm	6 Pt. Deep Metric Socket	14mm
1126	Combination Wrench, 12 Pt.	13/16"	30-19mm	6 Pt. Standard Metric Socket	19mm	35-15mm	6 Pt. Deep Metric Socket	15mm
1128	Combination Wrench, 12 Pt.	7/8"	3120	12 Pt. Standard Socket	5/8"	35-16mm	6 Pt. Deep Metric Socket	16mm
1130	Combination Wrench, 12 Pt.	15/16"	3122	12 Pt. Standard Socket	11/16"	35-17mm	6 Pt. Deep Metric Socket	17mm
1132	Combination Wrench, 12 Pt.	1"	3124	12 Pt. Standard Socket	3/4"	35-18mm	6 Pt. Deep Metric Socket	18mm
1134	Combination Wrench, 12 Pt.	1-1/16"	3126	12 Pt. Standard Socket	13/16"	35-19mm	6 Pt. Deep Metric Socket	19mm
1136	Combination Wrench, 12 Pt.	1-1/8"	3128	12 Pt. Standard Socket	7/8"	3712	12 Pt. Flex Socket	3/8"
1140	Combination Wrench, 12 Pt.	1-1/4"	3130	12 Pt. Standard Socket	15/16"	3714	12 Pt. Flex Socket	7/16"
1310	Open End Wrench	1/4" x 5/16"	3132	12 Pt. Standard Socket	1"	3716	12 Pt. Flex Socket	1/2"
1314	Open End Wrench	3/8" x 7/16"	32-02mm	Metric Hex Bit Socket	2mm	3718	12 Pt. Flex Socket	9/16"
1318	Open End Wrench	1/2" x 9/16"	32-02.5mm	Metric Hex Bit Socket	2.5mm	3720	12 Pt. Flex Socket	5/8"
1322	Open End Wrench	5/8" x 11/16"	32-03mm	Metric Hex Bit Socket	3mm	3722	12 Pt. Flex Socket	11/16"
1326	Open End Wrench	3/4" x 13/16"	32-04mm	Metric Hex Bit Socket	4mm	3724	12 Pt. Flex Socket	3/4"
1330	Open End Wrench	7/8" x 15/16"	32-05mm	Metric Hex Bit Socket	5mm	1/2" DRIVE SOCKETS & ATTACHMENTS		
1/4" DRIVE SOCKETS & ATTACHMENTS			32-06mm	Metric Hex Bit Socket	6mm	4112	12 Pt. Standard Socket	3/8"
2005	6 Pt. Standard Socket	5/32"	32-07mm	Metric Hex Bit Socket	7mm	4114	12 Pt. Standard Socket	7/16"
2006	6 Pt. Standard Socket	3/16"	32-08mm	Metric Hex Bit Socket	8mm	4116	12 Pt. Standard Socket	1/2"
2007	6 Pt. Standard Socket	7/32"	32-10mm	Metric Hex Bit Socket	10mm	4118	12 Pt. Standard Socket	9/16"
2008	6 Pt. Standard Socket	1/4"	3204	Hex Bit Socket	1/8"	4120	12 Pt. Standard Socket	5/8"
2009	6 Pt. Standard Socket	9/32"	3205	Hex Bit Socket	5/32"	4122	12 Pt. Standard Socket	11/16"
2010	6 Pt. Standard Socket	5/16"	3206	Hex Bit Socket	3/16"	4124	12 Pt. Standard Socket	3/4"
2011	6 Pt. Standard Socket	11/32"	3207	Hex Bit Socket	7/32"	4126	12 Pt. Standard Socket	13/16"
2012	6 Pt. Standard Socket	3/8"	3208	Hex Bit Socket	1/4"	4128	12 Pt. Standard Socket	7/8"
2014	6 Pt. Standard Socket	7/16"	3210	Hex Bit Socket	5/16"	4130	12 Pt. Standard Socket	15/16"
2016	6 Pt. Standard Socket	1/2"	3212	Hex Bit Socket	3/8"	4132	12 Pt. Standard Socket	1"
2308	Special 8 Pt. Standard Socket	1/4"	3260	Standard Screwdriver Socket with Bit	1/4"	4134	12 Pt. Standard Socket	1-1/16"
2310	Special 8 Pt. Standard Socket	5/16"	3262	Standard Screwdriver Socket with Bit	3/8"	4136	12 Pt. Standard Socket	1-1/8"
2312	Special 8 Pt. Standard Socket	3/8"	3266	Phillips Screwdriver Socket with Bit	#2	4140	12 Pt. Standard Socket	1-1/4"
2506	6 Pt. Deep Socket	3/16"	3267	Phillips Screwdriver Socket with Bit	#3	4405	5" Extension	
2508	6 Pt. Deep Socket	1/4"	3268	Phillips Screwdriver Socket with Bit	#4	4410	10" Extension	
			3403	3" Extension		4420	20" Extension	





Part No.	Description	Size
4426	Ratchet, 10-1/2" Series 400, Knurled Grip	
4435	Flex Handle	
4445	Speeder	
4453	Adapter, 1/2" F x 3/8" M	
4475	Universal	
4612	12 Pt. Deep Socket	3/8"
4614	12 Pt. Deep Socket	7/16"
4616	12 Pt. Deep Socket	1/2"
4618	12 Pt. Deep Socket	9/16"
4620	12 Pt. Deep Socket	5/8"
4622	12 Pt. Deep Socket	11/16"
4624	12 Pt. Deep Socket	3/4"
4626	12 Pt. Deep Socket	13/16"
4628	12 Pt. Deep Socket	7/8"
4630	12 Pt. Deep Socket	15/16"
4632	12 Pt. Deep Socket	1"
4634	12 Pt. Deep Socket	1-1/16"
4636	12 Pt. Deep Socket	1-1/8"
4638	12 Pt. Deep Socket	1-3/16"
4640	12 Pt. Deep Socket	1-1/4"
3/4" DRIVE SOCKETS & ATTACHMENTS		
6128	12 Pt. Standard Socket	7/8"
6130	12 Pt. Standard Socket	15/16"
6132	12 Pt. Standard Socket	1"
6134	12 Pt. Standard Socket	1-1/16"
6136	12 Pt. Standard Socket	1-1/8"
6140	12 Pt. Standard Socket	1-1/4"
6142	12 Pt. Standard Socket	1-5/16"
6144	12 Pt. Standard Socket	1-3/8"
6146	12 Pt. Standard Socket	1-7/16"
6148	12 Pt. Standard Socket	1-1/2"
6152	12 Pt. Standard Socket	1-5/8"
6154	12 Pt. Standard Socket	1-11/16"
6156	12 Pt. Standard Socket	1-3/4"
6158	12 Pt. Standard Socket	1-13/16"
6160	12 Pt. Standard Socket	1-7/8"
6164	12 Pt. Standard Socket	2"
6400	Ratchet	
6408	8" Extension	
6435	Flex Handle	
SERVICE TOOLS		
787	Miniature Combination Wrench Set, 10 Pieces	
798	Miniature Combination Wrench Set, 7/32" - 7/16", 8 Pieces	
9030	Soft Face Hammer	
9042	Ball Peen Hammer, Fiberglass Handle, 16 Oz.	
9105	Phillips Screwdriver #2 - 4"	
9106	Phillips Screwdriver #3 - 6"	
9123	Round Shank Screwdriver, 1/4" - 4"	
9125	Round Shank Screwdriver, 5/16" - 6"	
9126	Round Shank Screwdriver, 3/8" - 8"	
9132	Square Shank Screwdriver, 1/4" - 4"	
9134	Square Shank Screwdriver, 5/16" - 6"	
9136	Square Shank Screwdriver, 3/8" - 10"	
9181	Two-in-One Flip Screwdriver w/Pocket Clip #1 Phillips and 5/32" Slotted Blades. OAL 4-3/4"	
9184	Offset Screwdriver, 5/16"	
9186	Offset Screwdriver, #1 x #2	
9481	Gasket Scraper	
9520	Hacksaw	
9536	Center Punch, 1/4"	
9556	Starter Punch, 3/16" x 5"	
9576	Punch Bar, 5/8" x 18"	
9594	Pin Punch, 3/16" x 5-1/4"	
9602	Cold Chisel, 3/8" x 5-1/2"	
9604	Cold Chisel, 5/8" x 6-1/2"	
9685	Punch & Chisel Holder	
9702	Rectangular Inspection Mirror, 2-1/8" x 3-1/2",	
9AC10	Adjustable Wrench, Chrome, 10"	
9C326	Long Nose Pliers w/Side Cutter, 6"	
9C430	Tongue and Groove Pliers, (Channellock #430G), 10"	
9C437	Pliers, Box Joint (Channellock #326G), 6"	
9C526	Slip Joint Pliers Wire Cutting Shear, (Channellock #526G), 6"	
9E98010	Hex Key Set, Short Arm - 13 Pieces 11-1/2" x 15-1/2" Long	



WARNING
Wear safety goggles user and bystander.



WARNING
Before using tools, read safety information on pages 399-403.



WARNING
Comfort or plastic grips do not protect against electric shock.





Master Maintenance Set—1/4", 3/8" & 1/2" Drives

Set No. 121 –

**374 Pieces including WT814 Twelve
 Drawer Chest & WT896 Eleven Drawer
 Roller Cabinet**

Set No. 122 –

**372 Pieces
 (Tools Only - Cabinets Not Included)**

See Page 16 for photograph.

Part No.	Description	Size	Part No.	Description	Size	Part No.	Description	Size
FLAT WRENCHES								
1012	3/8" Drive Crowfoot Wrench	3/8"	2008	6 Pt. Standard Socket	1/4"	3132	12 Pt. Standard Socket	1"
1014	3/8" Drive Crowfoot Wrench	7/16"	2009	6 Pt. Standard Socket	9/32"	3204	Hex Bit Socket	1/8"
1016	3/8" Drive Crowfoot Wrench	1/2"	2010	6 Pt. Standard Socket	5/16"	3205	Hex Bit Socket	5/32"
1018	3/8" Drive Crowfoot Wrench	9/16"	2011	6 Pt. Standard Socket	11/32"	3206	Hex Bit Socket	3/16"
1020	3/8" Drive Crowfoot Wrench	5/8"	2012	6 Pt. Standard Socket	3/8"	3207	Hex Bit Socket	7/32"
1022	3/8" Drive Crowfoot Wrench	11/16"	2014	6 Pt. Standard Socket	7/16"	3208	Hex Bit Socket	1/4"
1024	3/8" Drive Crowfoot Wrench	3/4"	2016	6 Pt. Standard Socket	1/2"	3210	Hex Bit Socket	5/16"
1026	3/8" Drive Crowfoot Wrench	13/16"	2118	12 Pt. Standard Socket	9/16"	3212	Hex Bit Socket	3/8"
1028	3/8" Drive Crowfoot Wrench	7/8"	2202	Hex Bit Socket	1/16"	3260	Standard Screwdriver Socket with Bit	1/4"
1040	Combination Open End Flare Nut Wrench	3/8"	2203	Hex Bit Socket	5/64"	3266	Phillips Screwdriver Socket with Bit	#2
1042	Combination Open End Flare Nut Wrench	7/16"	2204	Hex Bit Socket	3/32"	3267	Phillips Screwdriver Socket with Bit	#3
1044	Combination Open End Flare Nut Wrench	1/2"	2205	Hex Bit Socket	7/64"	3268	Phillips Screwdriver Socket with Bit	#4
1046	Combination Open End Flare Nut Wrench	9/16"	2206	Hex Bit Socket	1/8"	3308	Special 8 Pt. Standard Socket	1/4"
1048	Combination Open End Flare Nut Wrench	5/8"	2207	Hex Bit Socket	9/64"	3310	Special 8 Pt. Standard Socket	5/16"
1050	Combination Open End Flare Nut Wrench	11/16"	2208	Hex Bit Socket	5/32"	3312	Special 8 Pt. Standard Socket	3/8"
1052	Combination Open End Flare Nut Wrench	3/4"	2210	Hex Bit Socket	3/16"	3314	Special 8 Pt. Standard Socket	7/16"
1110	Combination Wrench, 12 Pt.	5/16"	2212	Hex Bit Socket	7/32"	3316	Special 8 Pt. Standard Socket	1/2"
1112	Combination Wrench, 12 Pt.	3/8"	2214	Hex Bit Socket	1/4"	3403	3" Extension	
1114	Combination Wrench, 12 Pt.	7/16"	2218	Hex Bit Socket	5/16"	3405	5" Extension	
1116	Combination Wrench, 12 Pt.	1/2"	2260	Standard Screwdriver Socket with Bit (9204)	3/16"	3408	8" Extension	
1118	Combination Wrench, 12 Pt.	9/16"	2261	Standard Screwdriver Socket with Bit (9205)	1/4"	3410	3" Wobble Extension	
1120	Combination Wrench, 12 Pt.	5/8"	2263	Standard Screwdriver Socket with Bit	3/8"	3411	6" Wobble Extension	
1122	Combination Wrench, 12 Pt.	11/16"	2265	Phillips Screwdriver Socket with Bit (9200)	#1	3412	12" Extension	
1124	Combination Wrench, 12 Pt.	3/4"	2267	Long Phillips Screwdriver Socket with Bit (9202)	#1	3426	Ratchet, 7" Contour Grip	
1126	Combination Wrench, 12 Pt.	13/16"	2308	Special 8 Pt. Standard Socket	1/4"	3427	Flex Head Ratchet, 9-11/16" Knurled Steel Grip	
1128	Combination Wrench, 12 Pt.	7/8"	2310	Special 8 Pt. Standard Socket	5/16"	3435	Flex Handle	
1130	Combination Wrench, 12 Pt.	15/16"	2312	Special 8 Pt. Standard Socket	3/8"	3443	Sliding T	
1132	Combination Wrench, 12 Pt.	1"	2402	2" Extension		3445	Speeder, 14-1/2"	
1134	Combination Wrench, 12 Pt.	1-1/16"	2404	4" Extension		3475	Universal	
1136	Combination Wrench, 12 Pt.	1-1/8"	2406	6" Extension		3508	6 Pt. Deep Socket	1/4"
1140	Combination Wrench, 12 Pt.	1-1/4"	2426	Ratchet		3510	6 Pt. Deep Socket	5/16"
1310	Open End Wrench	1/4" x 5/16"	2435	Flex Handle		3612	12 Pt. Deep Socket	3/8"
1312	Open End Wrench	5/16" x 3/8"	2442	Spinner w/female end		3614	12 Pt. Deep Socket	7/16"
1316	Open End Wrench	7/16" x 1/2"	2445	Speed Handle		3616	12 Pt. Deep Socket	1/2"
1318	Open End Wrench	1/2" x 9/16"	2475	Universal Joint		3618	12 Pt. Deep Socket	9/16"
1320	Open End Wrench	9/16" x 5/8"	2506	6 Pt. Deep Socket	3/16"	3620	12 Pt. Deep Socket	5/8"
1324	Open End Wrench	5/8" x 3/4"	2507	6 Pt. Deep Socket	7/32"	3622	12 Pt. Deep Socket	11/16"
1325	Open End Wrench	11/16" x 3/4"	2508	6 Pt. Deep Socket	1/4"	3624	12 Pt. Deep Socket	3/4"
1329	Open End Wrench	13/16" x 7/8"	2509	6 Pt. Deep Socket	9/32"	3626	12 Pt. Deep Socket	13/16"
1332	Open End Wrench	15/16" x 1"	2510	6 Pt. Deep Socket	5/16"	3628	12 Pt. Deep Socket	7/8"
1336	Open End Wrench	1-1/16" x 1-1/8"	2511	6 Pt. Deep Socket	11/32"	3630	12 Pt. Deep Socket	15/16"
1642	Ratcheting Flare Nut Wrench	3/8"	2512	6 Pt. Deep Socket	3/8"	3632	12 Pt. Deep Socket	1"
1644	Ratcheting Flare Nut Wrench	7/16"	2514	6 Pt. Deep Socket	7/16"	3712	12 Pt. Flex Socket	3/8"
1646	Ratcheting Flare Nut Wrench	1/2"	2516	6 Pt. Deep Socket	1/2"	3714	12 Pt. Flex Socket	7/16"
1648	Ratcheting Flare Nut Wrench	9/16"	2618	12 Pt. Deep Socket	9/16"	3716	12 Pt. Flex Socket	1/2"
1650	Ratcheting Flare Nut Wrench	5/8"	2708	12 Pt. Standard Universal Socket	1/4"	3718	12 Pt. Flex Socket	9/16"
1652	Ratcheting Flare Nut Wrench	11/16"	2710	12 Pt. Standard Universal Socket	5/16"	3720	12 Pt. Flex Socket	5/8"
1654	Ratcheting Flare Nut Wrench	3/4"	2712	12 Pt. Standard Universal Socket	3/8"	3722	12 Pt. Flex Socket	11/16"
51012	12 Pt. Box Wrench - Modified Offset	5/16" x 3/8"	2714	12 Pt. Standard Universal Socket	7/16"	3724	12 Pt. Flex Socket	3/4"
51214	12 Pt. Box Wrench - Modified Offset	3/8" x 7/16"	3/8" DRIVE SOCKETS & ATTACHMENTS			1/2" DRIVE SOCKETS & ATTACHMENTS		
51416	12 Pt. Box Wrench - Modified Offset	7/16" x 1/2"	3108	12 Pt. Standard Socket	1/4"	4112	12 Pt. Standard Socket	3/8"
51618	12 Pt. Box Wrench - Modified Offset	1/2" x 9/16"	3110	12 Pt. Standard Socket	5/16"	4114	12 Pt. Standard Socket	7/16"
51820	12 Pt. Box Wrench - Modified Offset	9/16" x 5/8"	3112	12 Pt. Standard Socket	3/8"	4116	12 Pt. Standard Socket	1/2"
52024	12 Pt. Box Wrench - Modified Offset	5/8" x 3/4"	3114	12 Pt. Standard Socket	7/16"	4118	12 Pt. Standard Socket	9/16"
52224	12 Pt. Box Wrench - Modified Offset	11/16" x 3/4"	3116	12 Pt. Standard Socket	1/2"	4119	12 Pt. Standard Socket	19/32"
52628	12 Pt. Box Wrench - Modified Offset	13/16" x 7/8"	3118	12 Pt. Standard Socket	9/16"	4120	12 Pt. Standard Socket	5/8"
53032	12 Pt. Box Wrench - Modified Offset	15/16" x 1"	3120	12 Pt. Standard Socket	5/8"	4122	12 Pt. Standard Socket	11/16"
53436	12 Pt. Box Wrench - Modified Offset	1-1/16" x 1-1/8"	3122	12 Pt. Standard Socket	11/16"	4124	12 Pt. Standard Socket	3/4"
2006	6 Pt. Standard Socket	3/16"	3124	12 Pt. Standard Socket	3/4"	4125	12 Pt. Standard Socket	25/32"
2007	6 Pt. Standard Socket	7/32"	3126	12 Pt. Standard Socket	13/16"	4126	12 Pt. Standard Socket	13/16"
			3128	12 Pt. Standard Socket	7/8"	4128	12 Pt. Standard Socket	7/8"
			3130	12 Pt. Standard Socket	15/16"	4129	12 Pt. Standard Socket	29/32"

Master Set Contents

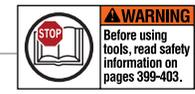



Part No.	Description	Size	Part No.	Description	Part No.	Description
4130	12 Pt. Standard Socket	15/16"	9137	Square Standard Tip 3/8" - 12"	9M472	Pinch Bar, 3/4" x 24"
4132	12 Pt. Standard Socket	1"	9181	Two-in-One Flip Screwdriver w/Pocket Clip #1 Phillips and 5/32" Slotted Blades. OAL 4-3/4"	9M482	Rolling Head Pry Bar, 1/2" x 16"
4134	12 Pt. Standard Socket	1-1/16"	9184	Offset Screwdriver, 5/16"	9M483	Rolling Head Pry Bar, 5/8" x 18"
4136	12 Pt. Standard Socket	1-1/8"	9186	Offset Screwdriver, #1 x #2	9P77S	Metal Cutting Snips - Straight, 7"
4138	12 Pt. Standard Socket	1-3/16"	9220	Hollow Shaft Nut Driver, 3/16"	9P6716S	Aviation Snips, Cuts Straight, Yellow, 10"
4140	12 Pt. Standard Socket	1-1/4"	9221	Hollow Shaft Nut Driver, 7/32"	9V10CR	Curved Jaw Locking Pliers, 10"
4142	12 Pt. Standard Socket	1-5/16"	9222	Hollow Shaft Nut Driver, 1/4"	9V6LN	Long Nose Locking Pliers, w/Wire Cutter, 6"
4144	12 Pt. Standard Socket	1-3/8"	9223	Hollow Shaft Nut Driver, 9/32"	9V7R	Straight Jaw Locking Pliers
4146	12 Pt. Standard Socket	1-7/16"	9224	Hollow Shaft Nut Driver, 5/16"	9E98010	Hex Key Set, Short Arm - 13 Pieces
4148	12 Pt. Standard Socket	1-1/2"	9225	Hollow Shaft Nut Driver, 11/32"		
4208	Hex Bit Socket	1/4"	9226	Hollow Shaft Nut Driver, 3/8"		
4210	Hex Bit Socket	5/16"	9227	Hollow Shaft Nut Driver, 7/16"		
4212	Hex Bit Socket	3/8"	9228	Hollow Shaft Nut Driver, 1/2"		
4214	Hex Bit Socket	7/16"	9229	Hollow Shaft Nut Driver, 9/16"		
4216	Hex Bit Socket	1/2"	9230	Hollow Shaft Nut Driver, 5/8"		
4218	Hex Bit Socket	9/16"	9381	Ratcheting Box Wrench, 6 Pt., 1/4" x 5/16"		
4220	Hex Bit Socket	5/8"	9382	Ratcheting Box Wrench, 6 Pt., 3/8" x 7/16"		
4312	Special 8 Pt. Standard Socket	3/8"	9383	Ratcheting Box Wrench, 6 Pt., 1/2" x 9/16"		
4314	Special 8 Pt. Standard Socket	7/16"	9384	Ratcheting Box Wrench, 12 Pt., 5/8" x 11/16"		
4316	Special 8 Pt. Standard Socket	1/2"	9386	Ratcheting Box Wrench, 12 Pt., 3/4" x 7/16"		
4318	Special 8 Pt. Standard Socket	9/16"	9R3100S	Ridgid Pipe Wrench, 8"		
4320	Special 8 Pt. Standard Socket	5/8"	9R31010	Ridgid Pipe Wrench, 10"		
4322	Special 8 Pt. Standard Socket	11/16"	9R31020	Ridgid Pipe Wrench, 14"		
4324	Special 8 Pt. Standard Socket	3/4"	9471	Stripper/Crimper/Cutter, 10-20 AWG		
4326	Special 8 Pt. Standard Socket	13/16"	9488	Flexible Scraper Blade, 1-1/4"		
4328	Special 8 Pt. Standard Socket	7/8"	9506	Tape Measure, 12' x 3/4"		
4332	Special 8 Pt. Standard Socket	1"	9520	Hacksaw		
4402	2" Extension		9526	Utility Knife		
4405	5" Extension		9535	Magnetic Pick-up Tool		
4410	10" Extension		9537	Center Punch, 1/4" x 3-1/2"		
4425	Ratchet - Long Handle		9538	Center Punch, 3/8" x 5"		
4426	Ratchet		9539	Center Punch, 1/2" x 6"		
4427	Flex Head Ratchet		9557	Starter Punch, 1/4" x 5"		
4435	Flex Handle		9563	Prick Punch, 5/16" x 4-1/4"		
4443	Sliding T		9576	Punch Bar, 5/8" x 18"		
4445	Speeder		9581	Line-Up Punch, 1/8" x 8"		
4475	Universal		9583	Line-Up Punch, 3/16" x 10"		
4477	Micro-Adjustable Metal Handle Torque Wrench		9584	Line-Up Punch, 1/4" x 12"		
4616	12 Pt. Deep Socket	1/2"	9592	Pin Punch, 1/8" x 4-3/4"		
4618	12 Pt. Deep Socket	9/16"	9593	Pin Punch, 5/32" x 5"		
4620	12 Pt. Deep Socket	5/8"	9594	Pin Punch, 3/16" x 5-1/4"		
4622	12 Pt. Deep Socket	11/16"	9595	Pin Punch, 7/32" x 5-1/2"		
4624	12 Pt. Deep Socket	3/4"	9596	Pin Punch, 1/4" x 5-3/4"		
4626	12 Pt. Deep Socket	13/16"	9600	Cold Chisel, 1/4" x 5"		
4628	12 Pt. Deep Socket	7/8"	9601	Cold Chisel, 5/16" x 5"		
4630	12 Pt. Deep Socket	15/16"	9603	Cold Chisel, 1/2" x 6"		
4632	12 Pt. Deep Socket	1"	9604	Cold Chisel, 5/8" x 6-1/2"		
4634	12 Pt. Deep Socket	1-1/16"	9605	Cold Chisel, 3/4" x 7"		
4636	12 Pt. Deep Socket	1-1/8"	9606	Cold Chisel, 7/8" x 7-1/2"		
4640	12 Pt. Deep Socket	1-1/4"	9607	Cold Chisel, 1" x 8"		
			9685	Punch & Chisel Holder		
			9702	Rectangular Inspection Mirror, 2-1/8" x 3-1/2", 11-1/2" x 15-1/2" Long		
			9AC06	Adjustable Wrench, 6"		
			9AC08	Adjustable Wrench, 8"		
			9AC10	Adjustable Wrench, 10"		
			9AC12	Adjustable Wrench, 12"		
			9C317	Long Nose Pliers w/Side Cutter, 7-1/2"		
			9C337	Pliers, Lap Joint		
			9C349	Linesmen Pliers - Wiremaster		
			9C357	Pliers, End Cutting		
			9C386	Long Nose Pliers, Curved w/Serrated Jaws, 6"		
			9C420	Tongue and Groove Pliers, 9-1/2"		
			9C424	Tongue and Groove Pliers, 4-1/2"		
			9C426	Tongue and Groove Pliers, 6-1/2"		
			9C436	Pliers, Box Joint		
			9C526	Slip Joint Pliers Wire Cutting Shear, 6"		
			9C537	Slip Joint Pliers, 16"		
			9C718	Duck Bill Needle Nose, 7"		
			9G85101	Screw Extractor, #1		
			9G85102	Screw Extractor, #2		
			9G85103	Screw Extractor, #3		
			9G85104	Screw Extractor, #4		
			9G85105	Screw Extractor, #5		
			9H1221S	Retaining Ring Plier w/Adjustable Stop		
			9H1234	Retaining Ring Plier w/Replaceable Tips		

SERVICE TOOLS

787	Miniature Combination Wrench Set, 10 Pieces
798	Miniature Open End Wrench Set, 9 Pieces
9022	Rubber Mallet, 2-5/8" Head Dia. x 16-3/4" Length
9023	Dead Blow Hammer with Super Grip, 1 Lb.
9040	Ball Peen Hammer, Fiberglass Handle, 8 Oz.
9042	Ball Peen Hammer, Fiberglass Handle, 16 Oz.
9045	Ball Peen Hammer, Fiberglass Handle, 32 Oz.
90404B (2)	Deep Throat Forged Steel C-Clamp, Black Oxide, 4"
9101	Phillips Screwdriver #2 - 1-1/2"
9103	Phillips Screwdriver #0 - 1-1/2"
9104	Phillips Screwdriver #1 - 3"
9105	Phillips Screwdriver #2 - 4"
9106	Phillips Screwdriver #3 - 6"
9107	Phillips Screwdriver #1 - 6"
9108	Phillips Screwdriver #2 - 6"
9109	Phillips Screwdriver #4 - 8"
9112	Cabinet Tip Screwdriver, 1/8" - 3"
9113	Cabinet Tip Screwdriver, 1/8" - 5"
9114	Cabinet Tip Screwdriver, 3/16" - 3"
9115	Cabinet Tip Screwdriver, 3/16" - 4"
9117	Cabinet Tip Screwdriver, 3/16" - 8"
9122	Round Shank Screwdriver, 1/4" - 1-1/2"
9132	Square Shank Screwdriver, 1/4" - 4"
9134	Square Shank Screwdriver, 5/16" - 6"
9135	Square Shank Standard Tip, 3/8" - 8"





Intermediate Set-1/4", 3/8", 1/2" & 3/4" Drives

Set No. 125 –
256 Pieces including WT796
Eight Drawer Roller Cabinet

Set No. 126 –
255 Pieces
(Tools Only - Cabinet Not Included)

See Page 17 for photograph.

Part No.	Description	Size	Part No.	Description	Size	Part No.	Description	Size
FLAT WRENCHES			2512	6 Pt. Deep Socket	3/8"	4402	2" Extension	
1040	Combination Open End Flare Nut Wrench	3/8"	2514	6 Pt. Deep Socket	7/16"	4405	5" Extension	
1042	Combination Open End Flare Nut Wrench	7/16"	2516	6 Pt. Deep Socket	1/2"	4410	10" Extension	
1044	Combination Open End Flare Nut Wrench	1/2"	2618	12 Pt. Deep Socket	9/16"	4426	Ratchet, 10-1/2" Series 400, Knurled Grip	
1046	Combination Open End Flare Nut Wrench	9/16"	3/8" DRIVE SOCKETS & ATTACHMENTS			4435	Flex Handle	
1048	Combination Open End Flare Nut Wrench	5/8"	3112	12 Pt. Standard Socket	3/8"	4445	Speeder	
1050	Combination Open End Flare Nut Wrench	11/16"	3114	12 Pt. Standard Socket	7/16"	4475	Universal	
1052	Combination Open End Flare Nut Wrench	3/4"	3116	12 Pt. Standard Socket	1/2"	4478	Micro-Adjustable Torque Wrench, 30-250 Ft. Lbs.	
1110	Combination Wrench, 12 Pt.	5/16"	3118	12 Pt. Standard Socket	9/16"	4616	12 Pt. Deep Socket	1/2"
1112	Combination Wrench, 12 Pt.	3/8"	3120	12 Pt. Standard Socket	5/8"	4618	12 Pt. Deep Socket	9/16"
1114	Combination Wrench, 12 Pt.	7/16"	3122	12 Pt. Standard Socket	11/16"	4620	12 Pt. Deep Socket	5/8"
1116	Combination Wrench, 12 Pt.	1/2"	3124	12 Pt. Standard Socket	3/4"	4622	12 Pt. Deep Socket	11/16"
1118	Combination Wrench, 12 Pt.	9/16"	3126	12 Pt. Standard Socket	13/16"	4624	12 Pt. Deep Socket	3/4"
1120	Combination Wrench, 12 Pt.	5/8"	3128	12 Pt. Standard Socket	7/8"	4626	12 Pt. Deep Socket	13/16"
1122	Combination Wrench, 12 Pt.	11/16"	3204	Hex Bit Socket	1/8"	4628	12 Pt. Deep Socket	7/8"
1124	Combination Wrench, 12 Pt.	3/4"	3205	Hex Bit Socket	5/32"	4630	12 Pt. Deep Socket	15/16"
1126	Combination Wrench, 12 Pt.	13/16"	3206	Hex Bit Socket	3/16"	4632	12 Pt. Deep Socket	1"
1128	Combination Wrench, 12 Pt.	7/8"	3207	Hex Bit Socket	7/32"	4634	12 Pt. Deep Socket	1-1/16"
1130	Combination Wrench, 12 Pt.	15/16"	3208	Hex Bit Socket	1/4"	4636	12 Pt. Deep Socket	1-1/8"
1132	Combination Wrench, 12 Pt.	1"	3210	Hex Bit Socket	5/16"	4640	12 Pt. Deep Socket	1-1/4"
1134	Combination Wrench, 12 Pt.	1-1/16"	3212	Hex Bit Socket	3/8"	3/4" DRIVE SOCKETS & ATTACHMENTS		
1136	Combination Wrench, 12 Pt.	1-1/8"	3308	Special 8 Pt. Standard Socket	1/4"	6128	12 Pt. Standard Socket	7/8"
1140	Combination Wrench, 12 Pt.	1-1/4"	3310	Special 8 Pt. Standard Socket	5/16"	6130	12 Pt. Standard Socket	15/16"
1142	Combination Wrench, 12 Pt.	1-5/16"	3312	Special 8 Pt. Standard Socket	3/8"	6132	12 Pt. Standard Socket	1"
1144	Combination Wrench, 12 Pt.	1-3/8"	3403	3" Extension		6134	12 Pt. Standard Socket	1-1/16"
1146	Combination Wrench, 12 Pt.	1-7/16"	3405	5" Extension		6136	12 Pt. Standard Socket	1-1/8"
1148	Combination Wrench, 12 Pt.	1-1/2"	3412	12" Extension		6140	12 Pt. Standard Socket	1-1/4"
1310	Open End Wrench	1/4" x 5/16"	3426	Ratchet, 7" Knurled Grip		6142	12 Pt. Standard Socket	1-5/16"
1312	Open End Wrench	3/8" x 5/16"	3435	Flex Handle		6144	12 Pt. Standard Socket	1-3/8"
1316	Open End Wrench	7/8" x 1/2"	3445	Speeder, 14-1/2"		6146	12 Pt. Standard Socket	1-7/16"
1318	Open End Wrench	1/2" x 9/16"	3475	Universal		6148	12 Pt. Standard Socket	1-1/2"
1320	Open End Wrench	9/16" x 5/8"	3612	12 Pt. Deep Socket	3/8"	6152	12 Pt. Standard Socket	1-5/8"
1324	Open End Wrench	5/8" x 3/4"	3614	12 Pt. Deep Socket	7/16"	6156	12 Pt. Standard Socket	1-3/4"
1325	Open End Wrench	11/16" x 3/4"	3616	12 Pt. Deep Socket	1/2"	6158	12 Pt. Standard Socket	1-13/16"
1329	Open End Wrench	13/16" x 7/8"	3618	12 Pt. Deep Socket	9/16"	6160	12 Pt. Standard Socket	1-7/8"
1332	Open End Wrench	15/16" x 1"	3620	12 Pt. Deep Socket	5/8"	6164	12 Pt. Standard Socket	2"
1336	Open End Wrench	1-1/16" x 1-1/8"	3622	12 Pt. Deep Socket	11/16"	6400	Ratchet	
51214	12 Pt. Box Wrench - Modified Offset	3/8" x 7/16"	3624	12 Pt. Deep Socket	3/4"	6408	8" Extension	
51618	12 Pt. Box Wrench - Modified Offset	1/2" x 9/16"	3626	12 Pt. Deep Socket	13/16"	6416	16" Extension	
52022	12 Pt. Box Wrench - Modified Offset	5/8" x 11/16"	3628	12 Pt. Deep Socket	7/8"	6435	Flex Handle	
52426	12 Pt. Box Wrench - Modified Offset	3/4" x 13/16"	3714	12 Pt. Flex Socket	7/16"	6443	Sliding T	
1/4" DRIVE SOCKETS & ATTACHMENTS			3716	12 Pt. Flex Socket	1/2"	SERVICE TOOLS		
2006	6 Pt. Standard Socket	3/16"	3718	12 Pt. Flex Socket	9/16"	9023	Dead Blow Hammer with Super Grip, 1 Lb.	
2007	6 Pt. Standard Socket	7/32"	3720	12 Pt. Flex Socket	5/8"	9029	Brass Hammer with Super Grip, 2.5 Lbs.	
2008	6 Pt. Standard Socket	1/4"	3722	12 Pt. Flex Socket	11/16"	90404B	Deep Throat Forged Steel Body Clamps, 4", 2 each	
2009	6 Pt. Standard Socket	9/32"	3724	12 Pt. Flex Socket	3/4"	9042	Ball Peen Hammer, Fiberglass Handle, 16 Oz.	
2010	6 Pt. Standard Socket	5/16"	1/2" DRIVE SOCKETS & ATTACHMENTS			9045	Ball Peen Hammer, Fiberglass Handle, 32 Oz.	
2011	6 Pt. Standard Socket	11/32"	4112	12 Pt. Standard Socket	3/8"	9101	Phillips Screwdriver #2 - 1-1/2"	
2012	6 Pt. Standard Socket	3/8"	4114	12 Pt. Standard Socket	7/16"	9103	Phillips Screwdriver #0 - 3"	
2014	6 Pt. Standard Socket	7/16"	4116	12 Pt. Standard Socket	1/2"	9104	Phillips Screwdriver #1 - 3"	
2016	6 Pt. Standard Socket	1/2"	4118	12 Pt. Standard Socket	9/16"	9105	Phillips Screwdriver #2 - 4"	
2118	12 Pt. Standard Socket	9/16"	4120	12 Pt. Standard Socket	5/8"	9108	Phillips Screwdriver #2 - 6"	
2402	2" Extension		4122	12 Pt. Standard Socket	11/16"	9109	Phillips Screwdriver #4 - 8"	
2406	6" Extension		4124	12 Pt. Standard Socket	3/4"	9122	Round Shank Screwdriver, 1/4" - 1-1/2"	
2426	Ratchet, 4-3/4"		4126	12 Pt. Standard Socket	13/16"	9132	Square Shank Screwdriver, 1/4" - 4"	
2435	Flex Handle		4128	12 Pt. Standard Socket	7/8"	9133	Square Shank Screwdriver, 1/4" - 6"	
2442	Spinner w/female end		4130	12 Pt. Standard Socket	15/16"	9134	Square Shank Screwdriver, 5/16" - 6"	
2475	Universal Joint		4132	12 Pt. Standard Socket	1"	9135	Square Shank Standard Tip, 3/8" - 8"	
2506	6 Pt. Deep Socket	3/16"	4134	12 Pt. Standard Socket	1-1/16"	9137	Square Standard Tip 3/8" - 12"	
2507	6 Pt. Deep Socket	7/32"	4136	12 Pt. Standard Socket	1-1/8"	9181	Two-in-One Flip Screwdriver w/Pocket Clip #1 Phillips and 5/32" Slotted Blades. OAL 4-3/4"	
2508	6 Pt. Deep Socket	1/4"	4140	12 Pt. Standard Socket	1-1/4"	9184	Offset Screwdriver, 5/16"	
2509	6 Pt. Deep Socket	9/32"	4216	Hex Bit Socket	1/2"	9186	Offset Screwdriver, #1 x #2	
2510	6 Pt. Deep Socket	5/16"	4218	Hex Bit Socket	9/16"	9220	Hollow Shaft Nut Driver, 3/16"	
2511	6 Pt. Deep Socket	11/32"	4220	Hex Bit Socket	5/8"			

Master Set Contents



WARNING
Wear safety goggles user and bystander.



WARNING
Before using tools, read safety information on pages 399-403.



WARNING
Comfort or plastic grips do not protect against electric shock.



Part No.	Description
9221	Hollow Shaft Nut Driver, 7/32"
9222	Hollow Shaft Nut Driver, 1/4"
9223	Hollow Shaft Nut Driver, 9/32"
9224	Hollow Shaft Nut Driver, 5/16"
9225	Hollow Shaft Nut Driver, 11/32"
9226	Hollow Shaft Nut Driver, 3/8"
9381	Ratcheting Box Wrench, 6 Pt., 1/4" x 5/16"
9382	Ratcheting Box Wrench, 6 Pt., 3/8" x 7/16"
9383	Ratcheting Box Wrench, 6 Pt., 1/2" x 9/16"
9384	Ratcheting Box Wrench, 12 Pt., 5/8" x 11/16"
9386	Ratcheting Box Wrench, 12 Pt., 3/4" x 7/8"
9R31010	Ridgid Pipe Wrench, 10"
9R31020	Ridgid Pipe Wrench, 14"
9R31025	Ridgid Pipe Wrench, 18"
9471	Stripper/Crimper/Cutter, 10-20 AWG
9481	Gasket Scraper, Blade Width 1-1/2"
9506	Tape Measure, 12' x 3/4"
9520	Hacksaw
9526	Utility Knife
9538	Center Punch, 3/8" x 5"
9556	Starter Punch, 3/16" x 5"
9557	Starter Punch, 1/4" x 5"
9558	Starter Punch, 5/16" x 4-1/4"
9576	Punch Bar, 5/8" x 18"
9591	Pin Punch, 3/32" x 4-1/2"
9592	Pin Punch, 1/8" x 4-3/4"
9594	Pin Punch, 3/16" x 5-1/4"
9600	Cold Chisel, 1/4" x 5"
9602	Cold Chisel, 3/8" x 5-1/2"
9603	Cold Chisel, 1/2" x 6"
9613	Cold Chisel, 5/16"
9623	Round Nose Chisel, 5/16" x 6-1/4"
9685	Punch & Chisel Holder
9AC06	Adjustable Wrench, 6"
9AC08	Adjustable Wrench, 8"
9AC10	Adjustable Wrench, 10"
9AC12	Adjustable Wrench, 12"
9C317	Long Nose Pliers w/Side Cutter, 7-1/2"
9C326	Long Nose Pliers w/Side Cutter, 6"
9C337	Pliers, Lap Joint
9C347	Linesman Pliers, Round Nose, 7"
9C357	Pliers, End Cutting, 7"
9C386	Long Nose Pliers, Curved w/Serrated Jaws, 6"
9C430	Tongue and Groove Pliers, 10"
9C436	Pliers, Box Joint, 6"
9C460	Tongue and Groove Pliers, 16"
9C537	Slip Joint Pliers, 7"
9C718	Duck Bill Needle Nose, 7"
9G95202	Screw Extractor Set - 5 Pieces
9H1234	Retaining Ring Pliers w/Replaceable Tips
9M482	Rolling Head Pry Bar, 1/2" x 16"
9P6716L	Aviation Snips, Cuts Left, Red, 10"
9V10CR	Curved Jaw Locking Pliers, 10"
9V20R	Locking Chain Clamp Ridgid Pipe Wrench, 11"
9V7R	Straight Jaw Locking Pliers, 7"
9E88024	Hex Key Set, Short Arm, 11 Pieces in Pouch





Intermediate Set—1/4", 3/8" & 1/2" Drives

Set No. 130 –
220 Pieces including WT814 Twelve
Drawer Chest

Set No. 131 –
219 Pieces
(Tools Only - Cabinet Not Included)

See Page 18 for photograph.

Part No.	Description	Size	Part No.	Description	Size	Part No.	Description	Size
FLAT WRENCHES								
1040	Combination Open End Flare Nut Wrench	3/8"	3118	12 Pt. Standard Socket	9/16"	4620	12 Pt. Deep Socket	5/8"
1042	Combination Open End Flare Nut Wrench	7/16"	3120	12 Pt. Standard Socket	5/8"	4622	12 Pt. Deep Socket	11/16"
1044	Combination Open End Flare Nut Wrench	1/2"	3122	12 Pt. Standard Socket	11/16"	4624	12 Pt. Deep Socket	3/4"
1046	Combination Open End Flare Nut Wrench	9/16"	3124	12 Pt. Standard Socket	3/4"	4626	12 Pt. Deep Socket	13/16"
1048	Combination Open End Flare Nut Wrench	5/8"	3126	12 Pt. Standard Socket	13/16"	4628	12 Pt. Deep Socket	7/8"
1050	Combination Open End Flare Nut Wrench	11/16"	3128	12 Pt. Standard Socket	7/8"	4630	12 Pt. Deep Socket	15/16"
1052	Combination Open End Flare Nut Wrench	3/4"	3204	Hex Bit Socket	1/8"	4632	12 Pt. Deep Socket	1"
1110	Combination Wrench, 12 Pt.	5/16"	3205	Hex Bit Socket	5/32"	4634	12 Pt. Deep Socket	1-1/16"
1112	Combination Wrench, 12 Pt.	3/8"	3206	Hex Bit Socket	3/16"	4636	12 Pt. Deep Socket	1-1/8"
1114	Combination Wrench, 12 Pt.	7/16"	3207	Hex Bit Socket	7/32"	4640	12 Pt. Deep Socket	1-1/4"
1116	Combination Wrench, 12 Pt.	1/2"	3208	Hex Bit Socket	1/4"	SERVICE TOOLS		
1118	Combination Wrench, 12 Pt.	9/16"	3210	Hex Bit Socket	5/16"	9023	Dead Blow Hammer with Super Grip, 1 Lb.	
1120	Combination Wrench, 12 Pt.	5/8"	3212	Hex Bit Socket	3/8"	90404B	Deep Throat Forged Steel Body Clamps, 2 each	
1122	Combination Wrench, 12 Pt.	11/16"	3308	Special 8 Pt. Standard Socket	1/4"	9042	Ball Peen Hammer, Fiberglass Handle, 16 Oz.	
1124	Combination Wrench, 12 Pt.	3/4"	3310	Special 8 Pt. Standard Socket	5/16"	9045	Ball Peen Hammer, Fiberglass Handle, 32 Oz.	
1126	Combination Wrench, 12 Pt.	13/16"	3312	Special 8 Pt. Standard Socket	3/8"	9101	Phillips Screwdriver #2 - 1-1/2"	
1128	Combination Wrench, 12 Pt.	7/8"	3403	3" Extension		9103	Phillips Screwdriver #0 - 3"	
1130	Combination Wrench, 12 Pt.	15/16"	3405	5" Extension		9104	Phillips Screwdriver #1 - 3"	
1132	Combination Wrench, 12 Pt.	1"	3412	12" Extension		9105	Phillips Screwdriver #2 - 4"	
1134	Combination Wrench, 12 Pt.	1-1/16"	3426	Ratchet, 7" Knurled Grip		9106	Phillips Screwdriver #3 - 6"	
1136	Combination Wrench, 12 Pt.	1-1/8"	3435	Flex Handle		9109	Phillips Screwdriver #4 - 8"	
1140	Combination Wrench, 12 Pt.	1-1/4"	3445	Speeder, 14-1/2"		9122	Round Shank Screwdriver, 1/4" - 1-1/2"	
1310	Open End Wrench	1/4" x 5/16"	3475	Universal		9132	Square Shank Screwdriver, 1/4" - 4"	
1312	Open End Wrench	3/8" x 5/16"	3612	12 Pt. Deep Socket	3/8"	9134	Square Shank Screwdriver, 5/16" - 6"	
1316	Open End Wrench	7/8" x 1/2"	3614	12 Pt. Deep Socket	7/16"	9135	Square Shank Standard Tip, 3/8" - 8"	
1318	Open End Wrench	1/2" x 9/16"	3616	12 Pt. Deep Socket	1/2"	9137	Square Standard Tip 3/8" - 12"	
1320	Open End Wrench	9/16" x 5/8"	3618	12 Pt. Deep Socket	9/16"	9181	Two-in-One Flip Screwdriver w/Pocket Clip	
1324	Open End Wrench	5/8" x 3/4"	3620	12 Pt. Deep Socket	5/8"		#1 Phillips and 5/32" Slotted Blades. OAL 4-3/4"	
1325	Open End Wrench	11/16" x 3/4"	3622	12 Pt. Deep Socket	11/16"	9184	Offset Screwdriver, 5/16"	
1329	Open End Wrench	13/16" x 7/8"	3624	12 Pt. Deep Socket	3/4"	9186	Offset Screwdriver, #1 x #2	
1332	Open End Wrench	15/16" x 1"	3626	12 Pt. Deep Socket	13/16"	9220	Hollow Shaft Nut Driver, 3/16"	
1336	Open End Wrench	1-1/16" x 1-1/8"	3628	12 Pt. Deep Socket	7/8"	9221	Hollow Shaft Nut Driver, 7/32"	
1/4" DRIVE SOCKETS & ATTACHMENTS								
2006	6 Pt. Standard Socket	3/16"	3714	12 Pt. Flex Socket	7/16"	9222	Hollow Shaft Nut Driver, 1/4"	
2007	6 Pt. Standard Socket	7/32"	3716	12 Pt. Flex Socket	1/2"	9223	Hollow Shaft Nut Driver, 9/32"	
2008	6 Pt. Standard Socket	1/4"	3718	12 Pt. Flex Socket	9/16"	9224	Hollow Shaft Nut Driver, 5/16"	
2009	6 Pt. Standard Socket	9/32"	3720	12 Pt. Flex Socket	5/8"	9225	Hollow Shaft Nut Driver, 11/32"	
2010	6 Pt. Standard Socket	5/16"	3724	12 Pt. Flex Socket	3/4"	9226	Hollow Shaft Nut Driver, 3/8"	
2011	6 Pt. Standard Socket	11/32"	1/2" DRIVE SOCKETS & ATTACHMENTS					
2012	6 Pt. Standard Socket	3/8"	4112	12 Pt. Standard Socket	3/8"	9381	Ratcheting Box Wrench, 6 Pt., 1/4" x 5/16"	
2014	6 Pt. Standard Socket	7/16"	4114	12 Pt. Standard Socket	7/16"	9382	Ratcheting Box Wrench, 6 Pt., 3/8" x 7/16"	
2016	6 Pt. Standard Socket	1/2"	4116	12 Pt. Standard Socket	1/2"	9383	Ratcheting Box Wrench, 6 Pt., 1/2" x 9/16"	
2118	12 Pt. Standard Socket	9/16"	4118	12 Pt. Standard Socket	9/16"	9384	Ratcheting Box Wrench, 12 Pt., 5/8" x 11/16"	
2402	2" Extension		4120	12 Pt. Standard Socket	5/8"	9386	Ratcheting Box Wrench, 12 Pt., 3/4" x 7/8"	
2406	6" Extension		4122	12 Pt. Standard Socket	11/16"	9R31010	Ridgid Pipe Wrench, 10"	
2426	Ratchet, 4-3/4"		4124	12 Pt. Standard Socket	3/4"	9471	Stripper/Crimper/Cutter, 10-20 AWG	
2435	Flex Handle		4126	12 Pt. Standard Socket	13/16"	9481	Gasket Scraper, Blade Width 1-1/2"	
2442	Spinner w/female end		4128	12 Pt. Standard Socket	7/8"	9506	Tape Measure, 12" x 3/4"	
2475	Universal Joint		4130	12 Pt. Standard Socket	15/16"	9520	Hacksaw	
2506	6 Pt. Deep Socket	3/16"	4132	12 Pt. Standard Socket	1"	9526	Utility Knife	
2507	6 Pt. Deep Socket	7/32"	4134	12 Pt. Standard Socket	1-1/16"	9538	Center Punch, 3/8" x 5"	
2508	6 Pt. Deep Socket	1/4"	4136	12 Pt. Standard Socket	1-1/8"	9556	Starter Punch, 3/16" x 5"	
2509	6 Pt. Deep Socket	9/32"	4140	12 Pt. Standard Socket	1-1/4"	9557	Starter Punch, 1/4" x 5"	
2510	6 Pt. Deep Socket	5/16"	4216	Hex Bit Socket	1/2"	9558	Starter Punch, 5/16" x 4-1/4"	
2511	6 Pt. Deep Socket	11/32"	4218	Hex Bit Socket	9/16"	9576	Punch Bar, 5/8" x 18"	
2512	6 Pt. Deep Socket	3/8"	4220	Hex Bit Socket	5/8"	9591	Pin Punch, 3/32" x 4-1/2"	
2514	6 Pt. Deep Socket	7/16"	4402	2" Extension		9592	Pin Punch, 1/8" x 4-3/4"	
2516	6 Pt. Deep Socket	1/2"	4405	5" Extension		9594	Pin Punch, 3/16" x 5-1/4"	
2618	12 Pt. Deep Socket	9/16"	4410	10" Extension		9600	Cold Chisel, 1/4" x 5"	
3/8" DRIVE SOCKETS & ATTACHMENTS								
3112	12 Pt. Standard Socket	3/8"	4426	Ratchet, 10-1/2" Series 400, Knurled Grip		9602	Cold Chisel, 3/8" x 5-1/2"	
3114	12 Pt. Standard Socket	7/16"	4435	Flex Handle		9603	Cold Chisel, 1/2" x 6"	
3116	12 Pt. Standard Socket	1/2"	4445	Speeder		9613	Cape Chisel, 5/16"	
			4475	Universal		9623	Round Nose Chisel, 5/16"	
			4616	12 Pt. Deep Socket	1/2"	9685	Punch & Chisel Holder	
			4618	12 Pt. Deep Socket	9/16"	9AC06	Adjustable Wrench, 6"	
						9AC08	Adjustable Wrench, 8"	





Part No. Description

9AC10	Adjustable Wrench, 10"
9C326	Long Nose Pliers w/Side Cutter, 6"
9C337	Pliers, Lap Joint
9C349	Linesman Pliers, Wiremaster
9C357	Pliers, End Cutting
9C386	Long Nose Pliers, Curved w/Serrated Jaws, 6"
9C430	Tongue and Groove Pliers, 10"
9C436	Pliers, Box Joint
9C537	Slip Joint Pliers, 16"
9C718	Duck Bill Needle Nose, 7"
9H1221S	Retaining Ring Pliers w/Adj. Stop & Replaceable tips
9H1234	Retaining Ring Plier w/Replaceable Tips
9V7R	Straight Jaw Locking Pliers, 7"
9V10CR	Curved Jaw Locking Pliers, 10"
9P6716L	Aviation Snips, Cuts Left, Red, 10"
9E88024	Hex Key Set, Short Arm, 11 Pieces in Pouch
9G95202	Screw Extractor Set - 5 Pieces
9M482	Rolling Head Pry Bar, 1/2" x 16"





General Maintenance Set—1/4", 3/8" & 1/2" Drives

Set No. 135 –
135 Pieces including WT523
Three Drawer Chest

Set No. 136 –
134 Pieces
(Tools Only - Cabinet Not Included)

See Page 19 for photograph.

Part No.	Description	Size	Part No.	Description	Size
FLAT WRENCHES					
1112	Combination Wrench, 12 Pt.	3/8"	3520	6 Pt. Deep Socket	5/8"
1114	Combination Wrench, 12 Pt.	7/16"	3522	6 Pt. Deep Socket	11/16"
1116	Combination Wrench, 12 Pt.	1/2"	3524	6 Pt. Deep Socket	3/4"
1118	Combination Wrench, 12 Pt.	9/16"	3526	6 Pt. Deep Socket	13/16"
1120	Combination Wrench, 12 Pt.	5/8"	3528	6 Pt. Deep Socket	7/8"
1122	Combination Wrench, 12 Pt.	11/16"	1/2" DRIVE SOCKETS & ATTACHMENTS		
1124	Combination Wrench, 12 Pt.	3/4"	4112	12 Pt. Standard Socket	3/8"
1126	Combination Wrench, 12 Pt.	13/16"	4114	12 Pt. Standard Socket	7/16"
1128	Combination Wrench, 12 Pt.	7/8"	4116	12 Pt. Standard Socket	1/2"
1130	Combination Wrench, 12 Pt.	15/16"	4118	12 Pt. Standard Socket	9/16"
1132	Combination Wrench, 12 Pt.	1"	4120	12 Pt. Standard Socket	5/8"
1134	Combination Wrench, 12 Pt.	1-1/16"	4122	12 Pt. Standard Socket	11/16"
1136	Combination Wrench, 12 Pt.	1-1/8"	4124	12 Pt. Standard Socket	3/4"
1140	Combination Wrench, 12 Pt.	1-1/4"	4126	12 Pt. Standard Socket	13/16"
1310	Open End Wrench	1/4" x 5/16"	4128	12 Pt. Standard Socket	7/8"
1314	Open End Wrench	3/8" x 7/16"	4130	12 Pt. Standard Socket	15/16"
1318	Open End Wrench	1/2" x 9/16"	4132	12 Pt. Standard Socket	1"
1322	Open End Wrench	5/8" x 11/16"	4134	12 Pt. Standard Socket	1-1/16"
1326	Open End Wrench	3/4" x 13/16"	4136	12 Pt. Standard Socket	1-1/8"
1330	Open End Wrench	7/8" x 15/16"	4138	12 Pt. Standard Socket	1-3/16"
1340	Open End Wrench	1-1/8" x 1-1/4"	4140	12 Pt. Standard Socket	1-1/4"
51214	12 Pt. Box Wrench - Modified Offset	3/8" x 7/16"	4402	2" Extension	
51618	12 Pt. Box Wrench - Modified Offset	1/2" x 9/16"	4405	5" Extension	
52022	12 Pt. Box Wrench - Modified Offset	5/8" x 11/16"	4426	Ratchet, 10-1/2" Series 400, Knurled Grip	
52428	12 Pt. Box Wrench - Modified Offset	3/4" x 7/8"	4435	Flex Handle	
52830	12 Pt. Box Wrench - Modified Offset	7/8" x 15/16"	4475	Universal	
1/4" DRIVE SOCKETS & ATTACHMENTS					
2006	6 Pt. Standard Socket	3/16"	4516	6 Pt. Deep Socket	1/2"
2007	6 Pt. Standard Socket	7/32"	4518	6 Pt. Deep Socket	9/16"
2008	6 Pt. Standard Socket	1/4"	4520	6 Pt. Deep Socket	5/8"
2009	6 Pt. Standard Socket	9/32"	4522	6 Pt. Deep Socket	11/16"
2010	6 Pt. Standard Socket	5/16"	4524	6 Pt. Deep Socket	3/4"
2011	6 Pt. Standard Socket	11/32"	SERVICE TOOLS		
2012	6 Pt. Standard Socket	3/8"	798	Miniature Combination Wrench Set, 8 Pieces	
2014	6 Pt. Standard Socket	7/16"	9032	Soft Face Hammer	
2016	6 Pt. Standard Socket	1/2"	9040	Ball Peen Hammer, Fiberglass Handle, 8 Oz.	
2492	Ratchet, 5-1/4"		9041	Ball Peen Hammer, Fiberglass Handle, 12 Oz.	
2441	Spinner		9042	Ball Peen Hammer, Fiberglass Handle, 16 Oz.	
3/8" DRIVE SOCKETS & ATTACHMENTS					
3108	12 Pt. Standard Socket	1/4"	9104	Phillips Screwdriver #1 - 3"	
3110	12 Pt. Standard Socket	5/16"	9105	Phillips Screwdriver #2 - 4"	
3112	12 Pt. Standard Socket	3/8"	9132	Square Shank Screwdriver, 1/4" - 4"	
3114	12 Pt. Standard Socket	7/16"	9134	Square Shank Screwdriver, 5/16" - 6"	
3116	12 Pt. Standard Socket	1/2"	9135	Square Shank Standard Tip, 3/8" - 8"	
3118	12 Pt. Standard Socket	9/16"	9552	Starter Punch, 3/32"	
3120	12 Pt. Standard Socket	5/8"	9553	Starter Punch, 1/8"	
3122	12 Pt. Standard Socket	11/16"	9556	Starter Punch, 3/16" x 5"	
3124	12 Pt. Standard Socket	3/4"	9591	Pin Punch, 3/32" x 4-1/2"	
3126	12 Pt. Standard Socket	13/16"	9593	Pin Punch, 5/32"	
3128	12 Pt. Standard Socket	7/8"	9594	Pin Punch, 3/16" x 5-1/4"	
3403	3" Extension		9602	Cold Chisel, 3/8" x 5-1/2"	
3408	8" Extension		9603	Cold Chisel, 1/2" x 6"	
3412	12" Extension		9604	Cold Chisel, 5/8"	
3426	Ratchet, 7" Knurled Grip		9C317	Long Nose Pliers w/Side Cutter, 7-1/2"	
3435	Flex Handle		9C430	Tongue and Groove Pliers, 10"	
3443	Sliding T		9C447	Cutting Pliers, Curved Diagonal, Box Joint, 7-3/4"	
3445	Speeder, 14-1/2"		9C526	Slip Joint Pliers Wire Cutting Shear, 6"	
3475	Universal		9M482	Rolling Head Pry Bar, 1/2" x 16"	
3512	6 Pt. Deep Socket	3/8"	9E98010	Hex Key Set, Short Arm, 15 Pieces in Pouch	
3514	6 Pt. Deep Socket	7/16"			
3516	6 Pt. Deep Socket	1/2"			
3518	6 Pt. Deep Socket	9/16"			





Mechanics Set—1/4", 3/8" & 1/2" Drives

Set No. 140 –
140 Pieces including WT524
Two Drawer Chest

Set No. 141 –
139 Pieces
(Tools Only - Cabinet Not Included)

See Page 20 for photograph.

Part No.	Description	Size	Part No.	Description	Size
FLAT WRENCHES			3526	6 Pt. Deep Socket	13/16"
1112	Combination Wrench, 12 Pt.	3/8"	3528	6 Pt. Deep Socket	7/8"
1114	Combination Wrench, 12 Pt.	7/16"	3530	6 Pt. Deep Socket	15/16"
1116	Combination Wrench, 12 Pt.	1/2"	3532	6 Pt. Deep Socket	1"
1118	Combination Wrench, 12 Pt.	9/16"	1/2" DRIVE SOCKETS & ATTACHMENTS		
1120	Combination Wrench, 12 Pt.	5/8"	4012	6 Pt. Standard Socket	3/8"
1122	Combination Wrench, 12 Pt.	11/16"	4014	6 Pt. Standard Socket	7/16"
1124	Combination Wrench, 12 Pt.	3/4"	4016	6 Pt. Standard Socket	1/2"
1126	Combination Wrench, 12 Pt.	13/16"	4018	6 Pt. Standard Socket	9/16"
1128	Combination Wrench, 12 Pt.	7/8"	4020	6 Pt. Standard Socket	5/8"
1130	Combination Wrench, 12 Pt.	15/16"	4022	6 Pt. Standard Socket	11/16"
1314	Open End Wrench	3/8" x 7/16"	4024	6 Pt. Standard Socket	3/4"
1318	Open End Wrench	1/2" x 9/16"	4026	6 Pt. Standard Socket	13/16"
1322	Open End Wrench	5/8" x 11/16"	4028	6 Pt. Standard Socket	7/8"
1326	Open End Wrench	3/4" x 13/16"	4030	6 Pt. Standard Socket	15/16"
1330	Open End Wrench	7/8" x 15/16"	4032	6 Pt. Standard Socket	1"
1/4" DRIVE SOCKETS & ATTACHMENTS			4034	6 Pt. Standard Socket	1-1/16"
2006	6 Pt. Standard Socket	3/16"	4036	6 Pt. Standard Socket	1-1/8"
2007	6 Pt. Standard Socket	7/32"	4040	6 Pt. Standard Socket	1-1/4"
2008	6 Pt. Standard Socket	1/4"	4405	5" Extension	
2009	6 Pt. Standard Socket	9/32"	4410	10" Extension	
2010	6 Pt. Standard Socket	5/16"	4426	Ratchet, 10-1/2" Series 400, Knurled Grip	
2011	6 Pt. Standard Socket	11/32"	4435	Flex Handle, 18" Knurled Steel Grip	
2012	6 Pt. Standard Socket	3/8"	4445	Speeder	
2014	6 Pt. Standard Socket	7/16"	4475	Universal	
2016	6 Pt. Standard Socket	1/2"	4512	6 Pt. Deep Socket	3/8"
2308	Special 8 Pt. Standard Socket	1/4"	4514	6 Pt. Deep Socket	7/16"
2310	Special 8 Pt. Standard Socket	5/16"	4516	6 Pt. Deep Socket	1/2"
2312	Special 8 Pt. Standard Socket	3/8"	4518	6 Pt. Deep Socket	9/16"
2406	6" Extension		4520	6 Pt. Deep Socket	5/8"
2426	Ratchet, 4-3/4"		4522	6 Pt. Deep Socket	11/16"
2430	Bar		4524	6 Pt. Deep Socket	3/4"
2435	Flex Handle		4526	6 Pt. Deep Socket	13/16"
3/8" DRIVE SOCKETS & ATTACHMENTS			4528	6 Pt. Deep Socket	7/8"
3008	6 Pt. Standard Socket	1/4"	4530	6 Pt. Deep Socket	15/16"
3010	6 Pt. Standard Socket	5/16"	4532	6 Pt. Deep Socket	1"
3012	6 Pt. Standard Socket	3/8"	4534	6 Pt. Deep Socket	1-1/16"
3014	6 Pt. Standard Socket	7/16"	4536	6 Pt. Deep Socket	1-1/8"
3016	6 Pt. Standard Socket	1/2"	4540	6 Pt. Deep Socket	1-1/4"
3018	6 Pt. Standard Socket	9/16"	SERVICE TOOLS		
3020	6 Pt. Standard Socket	5/8"	787	Miniature Combination Wrench Set, 10 Pieces	
3022	6 Pt. Standard Socket	11/16"	9042	Ball Peen Hammer, Fiberglass Handle, 16 Oz.	
3024	6 Pt. Standard Socket	3/4"	9105	Phillips Screwdriver #2 - 4"	
3026	6 Pt. Standard Socket	13/16"	9123	Round Shank Screwdriver, 1/4" - 4"	
3028	6 Pt. Standard Socket	7/8"	9125	Round Shank Screwdriver, 5/16" - 6"	
3030	6 Pt. Standard Socket	15/16"	9126	Round Shank Screwdriver, 3/8" - 8"	
3032	6 Pt. Standard Socket	1"	9520	Hacksaw	
3403	3" Extension		9536	Center Punch, 1/4"	
3405	5" Extension		9556	Starter Punch, 3/16" x 5"	
3408	8" Extension		9576	Line-Up Pry Bar, 5/8" x 18"	
3426	Ratchet, 7" Knurled Grip		9594	Pin Punch, 3/16" x 5-1/4"	
3435	Flex Handle, 8-1/2 Knurled Steel Grip		9602	Cold Chisel, 3/8" x 5-1/2"	
3475	Universal		9604	Cold Chisel, 5/8"	
3508	6 Pt. Deep Socket	1/4"	9AC10	Adjustable Wrench, 10"	
3510	6 Pt. Deep Socket	5/16"	9C326	Long Nose Pliers, 6"	
3512	6 Pt. Deep Socket	3/8"	9C430	Tongue and Groove Pliers, 10"	
3514	6 Pt. Deep Socket	7/16"	9C437	Cutting Pliers, Box Joint, 7"	
3516	6 Pt. Deep Socket	1/2"	9E10113	Hex Key Set, Short Arm, 13 Pieces in Pouch	
3518	6 Pt. Deep Socket	9/16"			
3520	6 Pt. Deep Socket	5/8"			
3522	6 Pt. Deep Socket	11/16"			
3524	6 Pt. Deep Socket	3/4"			



WARNING
Wear safety goggles user and bystander.



WARNING
Before using tools, read safety information on pages 399-403.



WARNING
Comfort or plastic grips do not protect against electric shock.





General Service Set—1/4", 3/8" & 1/2" Drives

Set No. 150 –
132 Pieces including WT520 Heavy-Duty
Mechanic's Box with Tray

Set No. 152 –
131 Pieces
(Tools Only - Box Not Included)

See Page 21 for photograph.

Part No.	Description	Size	Part No.	Description	Size
FLAT WRENCHES			4618	12 Pt. Deep Socket	9/16"
1112	Combination Wrench, 12 Pt.	3/8"	4620	12 Pt. Deep Socket	5/8"
1114	Combination Wrench, 12 Pt.	7/16"	4622	12 Pt. Deep Socket	11/16"
1116	Combination Wrench, 12 Pt.	1/2"	4624	12 Pt. Deep Socket	3/4"
1118	Combination Wrench, 12 Pt.	9/16"	4626	12 Pt. Deep Socket	13/16"
1120	Combination Wrench, 12 Pt.	5/8"	4628	12 Pt. Deep Socket	7/8"
1122	Combination Wrench, 12 Pt.	11/16"	4630	12 Pt. Deep Socket	15/16"
1124	Combination Wrench, 12 Pt.	3/4"	SERVICE TOOLS		
1/4" DRIVE SOCKETS & ATTACHMENTS			798	Miniature Combination Wrench Set, 8 Pieces	
2006	6 Pt. Standard Socket	3/16"	9042	Ball Peen Hammer, Fiberglass Handle, 16 Oz.	
2007	6 Pt. Standard Socket	7/32"	9105	Phillips Screwdriver #2 - 4"	
2008	6 Pt. Standard Socket	1/4"	9115	Cabinet Tip Screwdriver 3/16" - 4"	
2009	6 Pt. Standard Socket	9/32"	9123	Round Shank Screwdriver, 1/4" - 4"	
2010	6 Pt. Standard Socket	5/16"	9125	Round Shank Screwdriver, 5/16" - 6"	
2011	6 Pt. Standard Socket	11/32"	9126	Round Shank Screwdriver, 3/8" - 8"	
2012	6 Pt. Standard Socket	3/8"	9381	Ratcheting Box Wrench, 6 Pt., 1/4" x 5/16"	
2014	6 Pt. Standard Socket	7/16"	9382	Ratcheting Box Wrench, 6 Pt., 3/8" x 7/16"	
2016	6 Pt. Standard Socket	1/2"	9383	Ratcheting Box Wrench, 6 Pt., 1/2" x 9/16"	
2308	Special 8 Pt. Standard Socket	1/4"	9491	Scraper, Stiff Blade, 1-1/4"	
2310	Special 8 Pt. Standard Socket	5/16"	9506	Tape Measure, 12' x 3/4"	
2312	Special 8 Pt. Standard Socket	3/8"	9520	Hacksaw	
2402	2" Extension		9521	Carbon Steel Blades, 10 Pieces	
2426	Ratchet, 4-3/4"		9535	Magnetic Pick-up Tool	
2441	Spinner		9536	Center Punch, 1/4"	
3/8" DRIVE SOCKETS & ATTACHMENTS			9556	Starter Punch, 3/16" x 5"	
3012	6 Pt. Standard Socket	3/8"	9575	Pinch Bar, 1/2" x 4"	
3014	6 Pt. Standard Socket	7/16"	9594	Pin Punch, 3/16" x 5-1/4"	
3016	6 Pt. Standard Socket	1/2"	9602	Cold Chisel, 3/8" x 5-1/2"	
3018	6 Pt. Standard Socket	9/16"	9604	Cold Chisel, 5/8" x 6-1/2"	
3120	12 Pt. Standard Socket	5/8"	9606	Cold Chisel, 7/8" x 7-1/2"	
3122	12 Pt. Standard Socket	11/16"	9AC10	Adjustable Wrench, 10"	
3124	12 Pt. Standard Socket	3/4"	9C326	Long Nose Pliers, 6"	
3126	12 Pt. Standard Socket	13/16"	9C430	Tongue and Groove Pliers, 10"	
3128	12 Pt. Standard Socket	7/8"	9C437	Cutting Pliers, Box Joint, 7"	
3403	3" Extension		9C526	Slip Joint Pliers Wire Cutting Shear, 6"	
3426	Ratchet, 7" Knurled Grip		9G95202	Screw Extractor Set - 5 Pieces	
3475	Universal		9V6LN	Long Nose Locking Pliers w/Wire Cutter, 6"	
3512	6 Pt. Deep Socket	3/8"	9V7CR	Curved Jaw Locking Pliers, 7"	
3514	6 Pt. Deep Socket	7/16"	9E10113	Hex Key Set, Short Arm, 13 Pieces in Pouch	
3516	6 Pt. Deep Socket	1/2"			
3518	6 Pt. Deep Socket	9/16"			
3520	6 Pt. Deep Socket	5/8"			
3522	6 Pt. Deep Socket	11/16"			
3524	6 Pt. Deep Socket	3/4"			
3526	6 Pt. Deep Socket	13/16"			
1/2" DRIVE SOCKETS & ATTACHMENTS					
4114	12 Pt. Standard Socket	7/16"			
4116	12 Pt. Standard Socket	1/2"			
4118	12 Pt. Standard Socket	9/16"			
4120	12 Pt. Standard Socket	5/8"			
4122	12 Pt. Standard Socket	11/16"			
4124	12 Pt. Standard Socket	3/4"			
4126	12 Pt. Standard Socket	13/16"			
4128	12 Pt. Standard Socket	7/8"			
4130	12 Pt. Standard Socket	15/16"			
4132	12 Pt. Standard Socket	1"			
4134	12 Pt. Standard Socket	1-1/16"			
4136	12 Pt. Standard Socket	1-1/8"			
4140	12 Pt. Standard Socket	1-1/4"			
4405	5" Extension				
4426	Ratchet, 10-1/2" Series 400, Knurled Grip				
4435	Flex Handle, 18" Knurled Steel Grip				
4616	12 Pt. Deep Socket	1/2"			





Basic Service Set—1/4", 3/8" & 1/2" Drives

Set No. 160 –
99 Pieces including WT520 Heavy-Duty
Mechanic's Box with Tray

Set No. 161 –
98 Pieces
(Tools Only - Box Not Included)

See Page 22 for photograph.

Part No.	Description	Size	Part No.	Description	Size
FLAT WRENCHES			4140	12 Pt. Standard Socket	1-1/4"
1112	Combination Wrench, 12 Pt.	3/8"	4405	5" Extension	
1114	Combination Wrench, 12 Pt.	7/16"	4426	Ratchet, 10-1/2" Series 400, Knurled Grip	
1116	Combination Wrench, 12 Pt.	1/2"	4435	Flex Handle, 18" Knurled Steel Grip	
1118	Combination Wrench, 12 Pt.	9/16"	4475	Universal Joint	
1120	Combination Wrench, 12 Pt.	5/8"	SERVICE TOOLS		
1122	Combination Wrench, 12 Pt.	11/16"	787	Miniature Combination Wrench Set, 10 Pieces	
1124	Combination Wrench, 12 Pt.	3/4"	9042	Ball Peen Hammer, Fiberglass Handle, 16 Oz.	
1314	Open End Wrench	3/8" x 7/16"	9105	Phillips Screwdriver #2 - 4"	
1318	Open End Wrench	1/2" x 9/16"	9123	Round Shank Screwdriver, 1/4" - 4"	
1322	Open End Wrench	5/8" x 11/16"	9125	Round Shank Screwdriver, 5/16" - 6"	
1326	Open End Wrench	3/4" x 9/16"	9126	Round Shank Screwdriver, 3/8" - 8"	
1/4" DRIVE SOCKETS & ATTACHMENTS			9536	Center Punch, 1/4"	
2006	6 Pt. Standard Socket	3/16"	9556	Starter Punch, 3/16" x 5"	
2007	6 Pt. Standard Socket	7/32"	9594	Pin Punch, 3/16" x 5-1/4"	
2008	6 Pt. Standard Socket	1/4"	9602	Cold Chisel, 3/8" x 5-1/2"	
2009	6 Pt. Standard Socket	9/32"	9604	Cold Chisel, 5/8" x 6-1/2"	
2010	6 Pt. Standard Socket	5/16"	9C430	Tongue and Groove Pliers, 10"	
2011	6 Pt. Standard Socket	11/32"	9E10113	Hex Key Set, Short Arm, 13 Pieces in Pouch	
2012	6 Pt. Standard Socket	3/8"			
2014	6 Pt. Standard Socket	7/16"			
2016	6 Pt. Standard Socket	1/2"			
2308	Special 8 Pt. Standard Socket	1/4"			
2310	Special 8 Pt. Standard Socket	5/16"			
2312	Special 8 Pt. Standard Socket	3/8"			
2430	Bar for Flex Handle				
2435	Flex Handle				
3/8" DRIVE SOCKETS & ATTACHMENTS					
3012	6 Pt. Standard Socket	3/8"			
3014	6 Pt. Standard Socket	7/16"			
3016	6 Pt. Standard Socket	1/2"			
3018	6 Pt. Standard Socket	9/16"			
3120	12 Pt. Standard Socket	5/8"			
3122	12 Pt. Standard Socket	11/16"			
3124	12 Pt. Standard Socket	3/4"			
3126	12 Pt. Standard Socket	13/16"			
3128	12 Pt. Standard Socket	7/8"			
3405	5" Extension				
3426	Ratchet, 7" Knurled Grip				
3435	Flex Handle				
3452	Adapter, 3/8" F x 1/4" M				
3475	Universal				
3512	6 Pt. Deep Socket	3/8"			
3514	6 Pt. Deep Socket	7/16"			
3516	6 Pt. Deep Socket	1/2"			
3518	6 Pt. Deep Socket	9/16"			
3520	6 Pt. Deep Socket	5/8"			
3522	6 Pt. Deep Socket	11/16"			
3524	6 Pt. Deep Socket	3/4"			
3526	6 Pt. Deep Socket	13/16"			
1/2" DRIVE SOCKETS & ATTACHMENTS					
4114	12 Pt. Standard Socket	7/16"			
4116	12 Pt. Standard Socket	1/2"			
4118	12 Pt. Standard Socket	9/16"			
4120	12 Pt. Standard Socket	5/8"			
4122	12 Pt. Standard Socket	11/16"			
4124	12 Pt. Standard Socket	3/4"			
4126	12 Pt. Standard Socket	13/16"			
4128	12 Pt. Standard Socket	7/8"			
4130	12 Pt. Standard Socket	15/16"			
4132	12 Pt. Standard Socket	1"			
4134	12 Pt. Standard Socket	1-1/16"			
4136	12 Pt. Standard Socket	1-1/8"			





Starter Set—3/8" & 1/2" Drives

Set No. 165 –
97 Pieces Including WT520 Heavy-Duty
Mechanic's Box with Tray

Set No. 166 –
96 Pieces
(Tools Only - Box Not Included)

See Page 23 for photograph.

Part No.	Description	Size	Part No.	Description	Size
FLAT WRENCHES					
1110	Combination Wrench, 12 Pt.	5/16"	9104	Phillips Screwdriver, #1 - 3"	
1112	Combination Wrench, 12 Pt.	3/8"	9105	Phillips Screwdriver #2 - 4"	
1114	Combination Wrench, 12 Pt.	7/16"	9106	Phillips Screwdriver #3 - 6"	
1116	Combination Wrench, 12 Pt.	1/2"	9114	Cabinet Tip Screwdriver, 3/16" - 3"	
1118	Combination Wrench, 12 Pt.	9/16"	9122	Round Shank Screwdriver, 1/4" - 1-1/2"	
1120	Combination Wrench, 12 Pt.	5/8"	9132	Square Shank Screwdriver, 1/4" - 4"	
1122	Combination Wrench, 12 Pt.	11/16"	9134	Square Shank Screwdriver, 5/16" - 6"	
1124	Combination Wrench, 12 Pt.	3/4"	9135	Square Shank Screwdriver, 3/8" - 8"	
1126	Combination Wrench, 12 Pt.	13/16"	9481	Gasket Scraper w/3-Flute Handle, 1-1/2"	
1128	Combination Wrench, 12 Pt.	7/8"	9520	Hacksaw	
1130	Combination Wrench, 12 Pt.	15/16"	9538	Center Punch, 3/8"	
1132	Combination Wrench, 12 Pt.	1"	9556	Starter Punch, 3/16" x 5"	
1134	Combination Wrench, 12 Pt.	1-1/16"	9557	Starter Punch, 1/4"	
1136	Combination Wrench, 12 Pt.	1-3/16"	9558	Starter Punch, 5/16"	
1140	Combination Wrench, 12 Pt.	1-1/4"	9591	Pin Punch, 3/32"	
3/8" DRIVE SOCKETS & ATTACHMENTS					
3112	12 Pt. Standard Socket	3/8"	9592	Pin Punch, 1/8"	
3114	12 Pt. Standard Socket	7/16"	9594	Pin Punch, 3/16"	
3116	12 Pt. Standard Socket	1/2"	9600	Cold Chisel, 1/4"	
3118	12 Pt. Standard Socket	9/16"	9602	Cold Chisel, 3/8"	
3120	12 Pt. Standard Socket	5/8"	9603	Cold Chisel, 1/2"	
3122	12 Pt. Standard Socket	11/16"	9613	Cape Chisel, 5/16"	
3124	12 Pt. Standard Socket	3/4"	9623	Round Nose Chisel, 5/16"	
3126	12 Pt. Standard Socket	13/16"	9685	Punch & Chisel Holder w/3-Flute Handle	
3128	12 Pt. Standard Socket	7/8"	9AC06	Adjustable Wrench, Chrome, 6"	
3403	3" Extension		9AC10	Adjustable Wrench, Chrome, 10"	
3412	12" Extension		9C326	Long Nose Pliers w/Side Cutter, 6"	
3426	Ratchet, 7" Knurled Grip		9C337	Lap Joint Pliers, 7"	
3435	Flex Handle, 8-1/2" Knurled Steel Grip		9C430	Tongue and Groove Pliers, 10"	
3445	Speeder		9C537	Slip Joint Pliers, 7"	
3475	Universal		9V7R	Straight Jaw Locking Pliers, 7"	
1/2" DRIVE SOCKETS & ATTACHMENTS					
4112	12 Pt. Standard Socket	3/8"	9P6716L	Aviation Snips, Cuts Left, Red, 10"	
4114	12 Pt. Standard Socket	7/16"	9E88022	Hex Key Set, Short Arm, 7 Pieces in Pouch	
4116	12 Pt. Standard Socket	1/2"			
4118	12 Pt. Standard Socket	9/16"			
4119	12 Pt. Standard Socket	19/32"			
4120	12 Pt. Standard Socket	5/8"			
4121	12 Pt. Standard Socket	21/32"			
4122	12 Pt. Standard Socket	11/16"			
4124	12 Pt. Standard Socket	3/4"			
4125	12 Pt. Standard Socket	25/32"			
4126	12 Pt. Standard Socket	13/16"			
4128	12 Pt. Standard Socket	7/8"			
4130	12 Pt. Standard Socket	15/16"			
4131	12 Pt. Standard Socket	31/32"			
4132	12 Pt. Standard Socket	1"			
4134	12 Pt. Standard Socket	1-1/16"			
4136	12 Pt. Standard Socket	1-1/8"			
4138	12 Pt. Standard Socket	1-3/16"			
4140	12 Pt. Standard Socket	1-1/4"			
4402	2" Extension				
4405	5" Extension				
4410	10" Extension				
4426	Ratchet, 10-1/2" Series 400, Knurled Grip				
4435	Flex Handle, 18" Knurled Steel Grip				
4445	Speeder				
4475	Universal				
SERVICE TOOLS					
9023	Dead Blow Hammer with Super Grip, 1 Lb.				
9042	Ball Peen Hammer, Fiberglass Handle, 16 Oz.				





Apprentice Set—3/8" Drive

Set No. 170 –

54 Pieces Including WT520 Heavy-Duty Mechanic's Box with Tray

Set No. 171 –

**53 Pieces
(Tools Only - Box Not Included)**

See Page 24 for photograph.

Part No.	Description	Size
FLAT WRENCHES		
1112	Combination Wrench, 12 Pt.	3/8"
1114	Combination Wrench, 12 Pt.	7/16"
1116	Combination Wrench, 12 Pt.	1/2"
1118	Combination Wrench, 12 Pt.	9/16"
1120	Combination Wrench, 12 Pt.	5/8"
1122	Combination Wrench, 12 Pt.	11/16"
1124	Combination Wrench, 12 Pt.	3/4"
1126	Combination Wrench, 12 Pt.	13/16"
1128	Combination Wrench, 12 Pt.	7/8"
1130	Combination Wrench, 12 Pt.	15/16"
3/8" DRIVE SOCKETS & ATTACHMENTS		
3012	6 Pt. Standard Socket	3/8"
3014	6 Pt. Standard Socket	7/16"
3016	6 Pt. Standard Socket	1/2"
3018	6 Pt. Standard Socket	9/16"
3120	12 Pt. Standard Socket	5/8"
3122	12 Pt. Standard Socket	11/16"
3124	12 Pt. Standard Socket	3/4"
3126	12 Pt. Standard Socket	13/16"
3128	12 Pt. Standard Socket	7/8"
3403	3" Extension	
3405	5" Extension	
3412	12" Extension	
3426	Ratchet, 7" Knurled Grip	
3435	Flex Handle	
3475	Universal	
3512	6 Pt. Deep Socket	3/8"
3514	6 Pt. Deep Socket	7/16"
3516	6 Pt. Deep Socket	1/2"
3518	6 Pt. Deep Socket	9/16"
3520	6 Pt. Deep Socket	5/8"
3522	6 Pt. Deep Socket	11/16"
3524	6 Pt. Deep Socket	3/4"
3526	6 Pt. Deep Socket	13/16"
3712	12 Pt. Flex Socket	3/8"
3714	12 Pt. Flex Socket	7/16"
3716	12 Pt. Flex Socket	1/2"
3718	12 Pt. Flex Socket	9/16"
3724	12 Pt. Flex Socket	3/4"
SERVICE TOOLS		
9030	Soft Face Hammer, 12 Oz., 1.25"	
9042	Ball Peen Hammer, Fiberglass Handle, 16 Oz.	
9105	Phillips Screwdriver #2 - 4"	
9123	Round Shank Screwdriver, 1/4" - 4"	
9125	Round Shank Screwdriver, 5/16" - 6"	
9126	Round Shank Screwdriver, 3/8" - 8"	
9536	Center Punch, 1/4"	
9556	Starter Punch, 3/16" x 5"	
9594	Pin Punch, 3/16" x 5-1/4"	
9602	Cold Chisel, 3/8" x 5-1/2"	
9604	Cold Chisel, 5/8" x 6-1/2"	
9AC10	Adjustable Wrench, 10"	
9C326	Long Nose Pliers w/Side Cutter, 6"	
9C437	Cutting Pliers, Box Joint, 7"	
9C526	Slip Joint Pliers Wire Cutting Shears, 6"	





Industrial Maintenance Set—1/4", 3/8" & 1/2" Drives

**Set No. 180 –
114 Pieces Including WT803 Six Drawer
Chest with Tray**

**Set No. 181 –
113 Pieces
(Tools Only - Chest Not Included)**

See Page 25 for photograph.

Part No.	Description	Size	Part No.	Description	Size
FLAT WRENCHES					
1108	Combination Wrench, 12 Pt.	1/4"	4124	12 Pt. Standard Socket	3/4"
1110	Combination Wrench, 12 Pt.	5/16"	4126	12 Pt. Standard Socket	13/16"
1112	Combination Wrench, 12 Pt.	3/8"	4128	12 Pt. Standard Socket	7/8"
1114	Combination Wrench, 12 Pt.	7/16"	4130	12 Pt. Standard Socket	15/16"
1116	Combination Wrench, 12 Pt.	1/2"	4132	12 Pt. Standard Socket	1"
1118	Combination Wrench, 12 Pt.	9/16"	4134	12 Pt. Standard Socket	1-1/16"
1120	Combination Wrench, 12 Pt.	5/8"	4136	12 Pt. Standard Socket	1-1/8"
1122	Combination Wrench, 12 Pt.	11/16"	4138	12 Pt. Standard Socket	1-3/16"
1124	Combination Wrench, 12 Pt.	3/4"	4140	12 Pt. Standard Socket	1-1/4"
1126	Combination Wrench, 12 Pt.	13/16"	4402	2" Extension	
1128	Combination Wrench, 12 Pt.	7/8"	4405	5" Extension	
1130	Combination Wrench, 12 Pt.	15/16"	4410	10" Extension	
1132	Combination Wrench, 12 Pt.	1"	4426	Ratchet, 10-1/2" Series 400, Knurled Grip	
1134	Combination Wrench, 12 Pt.	1-1/16"	4435	Flex Handle	
1136	Combination Wrench, 12 Pt.	1-1/8"	4475	Universal	
1140	Combination Wrench, 12 Pt.	1-1/4"	SERVICE TOOLS		
1310	Open End Wrench	1/4" x 5/16"	743-ROLL	Tool Roll - 3 Pockets	
1314	Open End Wrench	3/8" x 7/16"	798	Miniature Combination Wrench Set, 8 Pieces	
1318	Open End Wrench	1/2" x 9/16"	9030	Soft Face Hammer, 12 Oz., 1.25" Tip Dia.	
1322	Open End Wrench	5/8" x 11/16"	9042	Ball Peen Hammer, Fiberglass Handle, 16 Oz.	
1326	Open End Wrench	3/4" x 13/16"	9105	Phillips Screwdriver #2 - 4"	
1330	Open End Wrench	7/8" x 15/16"	9123	Round Shank Screwdriver, 1/4" - 4"	
1340	Open End Wrench	1-1/8" x 1-1/4"	9125	Round Shank Screwdriver, 5/16" - 6"	
1614	Flare Nut Wrench	3/8" x 7/16"	9126	Round Shank Screwdriver, 3/8" - 8"	
1618	Flare Nut Wrench	1/2" x 9/16"	9506	Tape Measure, 12' x 3/4"	
1622	Flare Nut Wrench	5/8" x 11/16"	9520	Hacksaw	
1/4" DRIVE SOCKETS & ATTACHMENTS			9522	Replaceable Hacksaw Blades, 12" - 24T, 10 each	
2006	6 Pt. Standard Socket	3/16"	9530	Feeler Gauge, 25-Blade	
2007	6 Pt. Standard Socket	7/32"	9660	Punch & Chisel Set - 6 Pieces	
2008	6 Pt. Standard Socket	1/4"	9AC08	Adjustable Wrench, 8"	
2009	6 Pt. Standard Socket	9/32"	9AC12	Adjustable Wrench, 12"	
2010	6 Pt. Standard Socket	5/16"	9C326	Long Nose Pliers w/Side Cutter, 6"	
2011	6 Pt. Standard Socket	11/32"	9C437	Box Joint Cutting Pliers, 7"	
2012	6 Pt. Standard Socket	3/8"	9P6716S	Aviation Snips, Cuts Straight, Yellow, 10"	
2014	6 Pt. Standard Socket	7/16"	9V7R	Straight Jaw Locking Pliers, 7"	
2016	6 Pt. Standard Socket	1/2"			
2402	2" Extension				
2406	6" Extension				
2426	Ratchet, 4-3/4"				
2435	Flex Handle				
2441	Spinner				
2475	Universal Joint				
3/8" DRIVE SOCKETS & ATTACHMENTS					
3112	12 Pt. Standard Socket	3/8"			
3114	12 Pt. Standard Socket	7/16"			
3116	12 Pt. Standard Socket	1/2"			
3118	12 Pt. Standard Socket	9/16"			
3120	12 Pt. Standard Socket	5/8"			
3122	12 Pt. Standard Socket	11/16"			
3124	12 Pt. Standard Socket	3/4"			
3403	3" Extension				
3408	8" Extension				
3412	12" Extension				
3426	Ratchet, 7" Knurled Grip				
3435	Flex Handle, 8-1/2" Knurled Steel Grip				
3475	Universal				
1/2" DRIVE SOCKETS & ATTACHMENTS					
4114	12 Pt. Standard Socket	7/16"			
4116	12 Pt. Standard Socket	1/2"			
4118	12 Pt. Standard Socket	9/16"			
4120	12 Pt. Standard Socket	5/8"			
4122	12 Pt. Standard Socket	11/16"			





Aircraft Mechanic's Starter Set—1/4", 3/8" & 1/2" Drives

Set No. 185 –
107 Pieces Including WT523
Three Drawer Chest

Set No. 186 –
106 Pieces
(Tools Only - Chest Not Included)

See Page 26 for photograph.

Part No.	Description	Size	Part No.	Description
FLAT WRENCHES			SERVICE TOOLS	
1110	Combination Wrench, 12 Pt.	5/16"	9030	Soft Face Hammer, 12 Oz., 1.25"
1112	Combination Wrench, 12 Pt.	3/8"	9040	Ball Peen Hammer, Fiberglass Handle, 8 Oz.
1114	Combination Wrench, 12 Pt.	7/16"	9104	Phillips Screwdriver #1 - 3"
1116	Combination Wrench, 12 Pt.	1/2"	9105	Phillips Screwdriver #2 - 4"
1118	Combination Wrench, 12 Pt.	9/16"	9106	Phillips Screwdriver #3 - 6"
1120	Combination Wrench, 12 Pt.	5/8"	9114	Cabinet Tip Screwdriver, 3/16" - 3"
1122	Combination Wrench, 12 Pt.	11/16"	9115	Cabinet Tip Screwdriver, 3/16" - 4"
1124	Combination Wrench, 12 Pt.	3/4"	9116	Cabinet Tip Screwdriver, 3/16" - 6"
1126	Combination Wrench, 12 Pt.	13/16"	9123	Round Shank Screwdriver, 1/4" - 4"
1128	Combination Wrench, 12 Pt.	7/8"	9125	Round Shank Screwdriver, 5/16" - 6"
1130	Combination Wrench, 12 Pt.	15/16"	9183	Offset Screwdriver, Std. Tip, 1/4"
1132	Combination Wrench, 12 Pt.	1"	9186	Offset Screwdriver, #1 x #2
1134	Combination Wrench, 12 Pt.	1-1/16"	9466	Safety Wire Twister Pliers, 10-3/8"
1136	Combination Wrench, 12 Pt.	1-1/8"	9520	Hacksaw
1140	Combination Wrench, 12 Pt.	1-1/4"	9521	Carbon Steel Blades, 10 each
1/4" DRIVE SOCKETS & ATTACHMENTS			9529	Feeler Gauge, 25-Blade Metric
2106	12 Pt. Standard Socket	3/16"	9534	Flexible Magnetic Retrieving Tool, 19-1/2"
2107	12 Pt. Standard Socket	7/32"	9535	Magnetic Pick-up Tool
2108	12 Pt. Standard Socket	1/4"	9538	Center Punch, 3/8" x 5"
2109	12 Pt. Standard Socket	9/32"	9558	Starter Punch, 5/16" x 4-1/4"
2110	12 Pt. Standard Socket	5/16"	9592	Pin Punch, 1/8" x 4-3/4"
2111	12 Pt. Standard Socket	11/32"	9594	Pin Punch, 3/16" x 5-1/4"
2112	12 Pt. Standard Socket	3/8"	9603	Cold Chisel, 1/2" x 6"
2114	12 Pt. Standard Socket	7/16"	9702	Rectangular Mirror
2116	12 Pt. Standard Socket	1/2"	9AC10	Adjustable Wrench, 10"
2118	12 Pt. Standard Socket	9/16"	9C326	Long Nose Pliers w/Side Cutter, 6"
2402	2" Extension		9C420	Tongue and Groove Pliers, 9-1/2"
2406	6" Extension		9C436	Pliers, Box Joint
2441	Spinner		9C526	Slip Joint Pliers Wire Cutting Shear, 6"
2475	Universal Joint		9C718	Duck Bill Needle Nose, 7"
2492	Ratchet		9P6716L	Aviation Snips, Cuts Left, Red, 10"
2606	12 Pt. Deep Socket	3/16"	9P6716R	Aviation Snips, Cuts Right, Green, 10"
2607	12 Pt. Deep Socket	7/32"	9P6716S	Aviation Snips, Cuts Straight, Yellow, 10"
2608	12 Pt. Deep Socket	1/4"	9V7R	Straight Jaw Locking Pliers, 7"
2609	12 Pt. Deep Socket	9/32"	9E88022	Hex Key Set, Short Arm, 7 Pieces
2610	12 Pt. Deep Socket	5/16"		
2611	12 Pt. Deep Socket	11/32"		
2612	12 Pt. Deep Socket	3/8"		
2614	12 Pt. Deep Socket	7/16"		
2616	12 Pt. Deep Socket	1/2"		
2618	12 Pt. Deep Socket	9/16"		
3/8" DRIVE SOCKETS & ATTACHMENTS				
3112	12 Pt. Standard Socket	3/8"		
3114	12 Pt. Standard Socket	7/16"		
3116	12 Pt. Standard Socket	1/2"		
3118	12 Pt. Standard Socket	9/16"		
3120	12 Pt. Standard Socket	5/8"		
3122	12 Pt. Standard Socket	11/16"		
3124	12 Pt. Standard Socket	3/4"		
3126	12 Pt. Standard Socket	13/16"		
3128	12 Pt. Standard Socket	7/8"		
3403	3" Extension			
3412	12" Extension			
3426	Ratchet, 7" Knurled Grip			
3435	Flex Handle, 8-1/2" Knurled Steel Grip			
3445	Speeder, 14-1/2"			
3454	Adapter, 3/8" F x 1/2" M			
3475	Universal			
1/2" DRIVE SOCKETS & ATTACHMENTS				
4528	6 Pt. Deep Socket	7/8"		



WARNING
Wear safety goggles user and bystander.



WARNING
Before using tools, read safety information on pages 399-403.



WARNING
Comfort or plastic grips do not protect against electric shock.





Metric Add-On Set-1/4", 3/8" & 1/2" Drives

**Set No. 189 –
151 Pieces (Tools Only)**

See Page 27 for photograph.

Part No.	Description	Size	Part No.	Description	Size	Part No.	Description	Size
FLAT WRENCHES								
10-10mm	3/8" Drive Metric Crowfoot Wrench	10mm	30-07mm	6 Pt. Standard Metric Socket	7mm	46-10mm	12 Pt. Deep Metric Socket	10mm
10-11mm	3/8" Drive Metric Crowfoot Wrench	11mm	31-08mm	12 Pt. Standard Metric Socket	8mm	46-11mm	12 Pt. Deep Metric Socket	11mm
10-12mm	3/8" Drive Metric Crowfoot Wrench	12mm	31-09mm	12 Pt. Standard Metric Socket	9mm	46-12mm	12 Pt. Deep Metric Socket	12mm
10-13mm	3/8" Drive Metric Crowfoot Wrench	13mm	31-10mm	12 Pt. Standard Metric Socket	10mm	46-13mm	12 Pt. Deep Metric Socket	13mm
10-14mm	3/8" Drive Metric Crowfoot Wrench	14mm	31-11mm	12 Pt. Standard Metric Socket	11mm	46-14mm	12 Pt. Deep Metric Socket	14mm
10-15mm	3/8" Drive Metric Crowfoot Wrench	15mm	31-12mm	12 Pt. Standard Metric Socket	12mm	46-15mm	12 Pt. Deep Metric Socket	15mm
10-16mm	3/8" Drive Metric Crowfoot Wrench	16mm	31-13mm	12 Pt. Standard Metric Socket	13mm	46-16mm	12 Pt. Deep Metric Socket	16mm
10-17mm	3/8" Drive Metric Crowfoot Wrench	17mm	31-14mm	12 Pt. Standard Metric Socket	14mm	46-17mm	12 Pt. Deep Metric Socket	17mm
10-18mm	3/8" Drive Metric Crowfoot Wrench	18mm	31-15mm	12 Pt. Standard Metric Socket	15mm	46-18mm	12 Pt. Deep Metric Socket	18mm
10-19mm	3/8" Drive Metric Crowfoot Wrench	19mm	31-16mm	12 Pt. Standard Metric Socket	16mm	46-19mm	12 Pt. Deep Metric Socket	19mm
11-06mm	Metric Combination Wrench, 12 Pt.	6mm	31-17mm	12 Pt. Standard Metric Socket	17mm	46-20mm	12 Pt. Deep Metric Socket	20mm
11-07mm	Metric Combination Wrench, 12 Pt.	7mm	31-18mm	12 Pt. Standard Metric Socket	18mm	46-21mm	12 Pt. Deep Metric Socket	21mm
11-08mm	Metric Combination Wrench, 12 Pt.	8mm	31-19mm	12 Pt. Standard Metric Socket	19mm	46-22mm	12 Pt. Deep Metric Socket	22mm
11-09mm	Metric Combination Wrench, 12 Pt.	9mm	31-20mm	12 Pt. Standard Metric Socket	20mm	46-24mm	12 Pt. Deep Metric Socket	24mm
11-10mm	Metric Combination Wrench, 12 Pt.	10mm	31-21mm	12 Pt. Standard Metric Socket	21mm	46-25mm	12 Pt. Deep Metric Socket	25mm
11-11mm	Metric Combination Wrench, 12 Pt.	11mm	31-22mm	12 Pt. Standard Metric Socket	22mm	46-26mm	12 Pt. Deep Metric Socket	26mm
11-12mm	Metric Combination Wrench, 12 Pt.	12mm	32-02.5mm	Metric Hex Bit Socket	2.5mm	SERVICE TOOLS		
11-13mm	Metric Combination Wrench, 12 Pt.	13mm	32-02mm	Metric Hex Bit Socket	2mm	9E98050	Hex Key Set, Long Arm Metric - 9 Pieces	
11-14mm	Metric Combination Wrench, 12 Pt.	14mm	32-03mm	Metric Hex Bit Socket	3mm			
11-15mm	Metric Combination Wrench, 12 Pt.	15mm	32-04mm	Metric Hex Bit Socket	4mm			
11-16mm	Metric Combination Wrench, 12 Pt.	16mm	32-05mm	Metric Hex Bit Socket	5mm			
11-17mm	Metric Combination Wrench, 12 Pt.	17mm	32-06mm	Metric Hex Bit Socket	6mm			
11-18mm	Metric Combination Wrench, 12 Pt.	18mm	32-08mm	Metric Hex Bit Socket	8mm			
11-19mm	Metric Combination Wrench, 12 Pt.	19mm	32-10mm	Metric Hex Bit Socket	10mm			
11-20mm	Metric Combination Wrench, 12 Pt.	20mm	35-06mm	6 Pt. Deep Metric Socket	6mm			
11-21mm	Metric Combination Wrench, 12 Pt.	21mm	35-07mm	6 Pt. Deep Metric Socket	7mm			
11-22mm	Metric Combination Wrench, 12 Pt.	22mm	35-08mm	6 Pt. Deep Metric Socket	8mm			
11-23mm	Metric Combination Wrench, 12 Pt.	23mm	35-09mm	6 Pt. Deep Metric Socket	9mm			
11-24mm	Metric Combination Wrench, 12 Pt.	24mm	35-10mm	6 Pt. Deep Metric Socket	10mm			
11-25mm	Metric Combination Wrench, 12 Pt.	25mm	35-11mm	6 Pt. Deep Metric Socket	11mm			
11-26mm	Metric Combination Wrench, 12 Pt.	26mm	35-12mm	6 Pt. Deep Metric Socket	12mm			
11-27mm	Metric Combination Wrench, 12 Pt.	27mm	35-13mm	6 Pt. Deep Metric Socket	13mm			
11-30mm	Metric Combination Wrench, 12 Pt.	30mm	35-14mm	6 Pt. Deep Metric Socket	14mm			
11-32mm	Metric Combination Wrench, 12 Pt.	32mm	35-15mm	6 Pt. Deep Metric Socket	15mm			
11-36mm	Metric Combination Wrench, 12 Pt.	36mm	35-16mm	6 Pt. Deep Metric Socket	16mm			
16-11mm	Metric Flare Nut Wrench, 6 Pt.	9mm x 11mm	35-17mm	6 Pt. Deep Metric Socket	17mm			
16-12mm	Metric Flare Nut Wrench, 6 Pt.	10mm x 12mm	35-18mm	6 Pt. Deep Metric Socket	18mm			
16-14mm	Metric Flare Nut Wrench, 6 Pt.	13mm x 14mm	35-19mm	6 Pt. Deep Metric Socket	19mm			
16-17mm	Metric Flare Nut Wrench, 6 Pt.	15mm x 17mm	1/2" DRIVE SOCKETS & ATTACHMENTS					
16-21mm	Metric Flare Nut Wrench, 6 Pt.	19mm x 21mm	41-09mm	12 Pt. Standard Metric Socket	9mm			
1/4" DRIVE SOCKETS			41-10mm	12 Pt. Standard Metric Socket	10mm			
20-04mm	6 Pt. Standard Metric Socket	4mm	41-11mm	12 Pt. Standard Metric Socket	11mm			
20-05mm	6 Pt. Standard Metric Socket	5mm	41-12mm	12 Pt. Standard Metric Socket	12mm			
20-06mm	6 Pt. Standard Metric Socket	6mm	41-13mm	12 Pt. Standard Metric Socket	13mm			
20-07mm	6 Pt. Standard Metric Socket	7mm	41-14mm	12 Pt. Standard Metric Socket	14mm			
20-08mm	6 Pt. Standard Metric Socket	8mm	41-15mm	12 Pt. Standard Metric Socket	15mm			
20-09mm	6 Pt. Standard Metric Socket	9mm	41-16mm	12 Pt. Standard Metric Socket	16mm			
20-10mm	6 Pt. Standard Metric Socket	10mm	41-17mm	12 Pt. Standard Metric Socket	17mm			
20-11mm	6 Pt. Standard Metric Socket	11mm	41-18mm	12 Pt. Standard Metric Socket	18mm			
20-12mm	6 Pt. Standard Metric Socket	12mm	41-19mm	12 Pt. Standard Metric Socket	19mm			
20-13mm	6 Pt. Standard Metric Socket	13mm	41-20mm	12 Pt. Standard Metric Socket	20mm			
20-14mm	6 Pt. Standard Metric Socket	14mm	41-21mm	12 Pt. Standard Metric Socket	21mm			
25-04mm	6 Pt. Deep Metric Socket	4mm	41-22mm	12 Pt. Standard Metric Socket	22mm			
25-05mm	6 Pt. Deep Metric Socket	5mm	41-23mm	12 Pt. Standard Metric Socket	23mm			
25-06mm	6 Pt. Deep Metric Socket	6mm	41-24mm	12 Pt. Standard Metric Socket	24mm			
25-07mm	6 Pt. Deep Metric Socket	7mm	41-25mm	12 Pt. Standard Metric Socket	25mm			
25-08mm	6 Pt. Deep Metric Socket	8mm	41-26mm	12 Pt. Standard Metric Socket	26mm			
25-09mm	6 Pt. Deep Metric Socket	9mm	41-27mm	12 Pt. Standard Metric Socket	27mm			
25-10mm	6 Pt. Deep Metric Socket	10mm	41-30mm	12 Pt. Standard Metric Socket	30mm			
25-11mm	6 Pt. Deep Metric Socket	11mm	41-32mm	12 Pt. Standard Metric Socket	32mm			
25-12mm	6 Pt. Deep Metric Socket	12mm	41-36mm	12 Pt. Standard Metric Socket	36mm			
25-13mm	6 Pt. Deep Metric Socket	13mm	42-12mm	Hex Bit Socket	12mm			
3/8" DRIVE SOCKETS & ATTACHMENTS			42-14mm	Hex Bit Socket	14mm			
30-06mm	6 Pt. Standard Metric Socket	6mm	42-17mm	Hex Bit Socket	17mm			
			46-09mm	12 Pt. Deep Metric Socket	9mm			





Master Metric Maintenance Set—1/4", 3/8" & 1/2" Drives

Set No. 190 –

264 Pieces Including WT814 Twelve Drawer Chest & WT896 Eleven Drawer Roller Cabinet

Set No. 191 –

262 Pieces (Tools Only - Cabinets Not Included)

See Page 28 for photograph.

Part No.	Description	Size	Part No.	Description	Size	Part No.	Description	Size
FLAT WRENCHES			25-06mm	6 Pt. Deep Metric Socket	6mm	35-16mm	6 Pt. Deep Metric Socket	16mm
10-10mm	3/8" Drive Metric Crowfoot Wrench	10mm	25-07mm	6 Pt. Deep Metric Socket	7mm	35-17mm	6 Pt. Deep Metric Socket	17mm
10-11mm	3/8" Drive Metric Crowfoot Wrench	11mm	25-08mm	6 Pt. Deep Metric Socket	8mm	35-18mm	6 Pt. Deep Metric Socket	18mm
10-12mm	3/8" Drive Metric Crowfoot Wrench	12mm	25-09mm	6 Pt. Deep Metric Socket	9mm	35-19mm	6 Pt. Deep Metric Socket	19mm
10-13mm	3/8" Drive Metric Crowfoot Wrench	13mm	25-10mm	6 Pt. Deep Metric Socket	10mm	1/2" DRIVE SOCKETS & ATTACHMENTS		
10-14mm	3/8" Drive Metric Crowfoot Wrench	14mm	25-11mm	6 Pt. Deep Metric Socket	11mm	41-09mm	12 Pt. Standard Metric Socket	9mm
10-15mm	3/8" Drive Metric Crowfoot Wrench	15mm	25-12mm	6 Pt. Deep Metric Socket	12mm	41-10mm	12 Pt. Standard Metric Socket	10mm
10-16mm	3/8" Drive Metric Crowfoot Wrench	16mm	25-13mm	6 Pt. Deep Metric Socket	13mm	41-11mm	12 Pt. Standard Metric Socket	11mm
10-17mm	3/8" Drive Metric Crowfoot Wrench	17mm	3/8" DRIVE SOCKETS & ATTACHMENTS			41-12mm	12 Pt. Standard Metric Socket	12mm
10-18mm	3/8" Drive Metric Crowfoot Wrench	18mm	30-06mm	6 Pt. Standard Metric Socket	6mm	41-13mm	12 Pt. Standard Metric Socket	13mm
10-19mm	3/8" Drive Metric Crowfoot Wrench	19mm	30-07mm	6 Pt. Standard Metric Socket	7mm	41-14mm	12 Pt. Standard Metric Socket	14mm
11-06mm	Metric Combination Wrench, 12 Pt.	6mm	31-08mm	12 Pt. Standard Metric Socket	8mm	41-15mm	12 Pt. Standard Metric Socket	15mm
11-07mm	Metric Combination Wrench, 12 Pt.	7mm	31-09mm	12 Pt. Standard Metric Socket	9mm	41-16mm	12 Pt. Standard Metric Socket	16mm
11-08mm	Metric Combination Wrench, 12 Pt.	8mm	31-10mm	12 Pt. Standard Metric Socket	10mm	41-17mm	12 Pt. Standard Metric Socket	17mm
11-09mm	Metric Combination Wrench, 12 Pt.	9mm	31-11mm	12 Pt. Standard Metric Socket	11mm	41-18mm	12 Pt. Standard Metric Socket	18mm
11-10mm	Metric Combination Wrench, 12 Pt.	10mm	31-12mm	12 Pt. Standard Metric Socket	12mm	41-19mm	12 Pt. Standard Metric Socket	19mm
11-11mm	Metric Combination Wrench, 12 Pt.	11mm	31-13mm	12 Pt. Standard Metric Socket	13mm	41-20mm	12 Pt. Standard Metric Socket	20mm
11-12mm	Metric Combination Wrench, 12 Pt.	12mm	31-14mm	12 Pt. Standard Metric Socket	14mm	41-21mm	12 Pt. Standard Metric Socket	21mm
11-13mm	Metric Combination Wrench, 12 Pt.	13mm	31-15mm	12 Pt. Standard Metric Socket	15mm	41-22mm	12 Pt. Standard Metric Socket	22mm
11-14mm	Metric Combination Wrench, 12 Pt.	14mm	31-16mm	12 Pt. Standard Metric Socket	16mm	41-23mm	12 Pt. Standard Metric Socket	23mm
11-15mm	Metric Combination Wrench, 12 Pt.	15mm	31-17mm	12 Pt. Standard Metric Socket	17mm	41-24mm	12 Pt. Standard Metric Socket	24mm
11-16mm	Metric Combination Wrench, 12 Pt.	16mm	31-18mm	12 Pt. Standard Metric Socket	18mm	41-25mm	12 Pt. Standard Metric Socket	25mm
11-17mm	Metric Combination Wrench, 12 Pt.	17mm	31-19mm	12 Pt. Standard Metric Socket	19mm	41-26mm	12 Pt. Standard Metric Socket	26mm
11-18mm	Metric Combination Wrench, 12 Pt.	18mm	31-20mm	12 Pt. Standard Metric Socket	20mm	41-27mm	12 Pt. Standard Metric Socket	27mm
11-19mm	Metric Combination Wrench, 12 Pt.	19mm	31-21mm	12 Pt. Standard Metric Socket	21mm	41-28mm	12 Pt. Standard Metric Socket	28mm
11-20mm	Metric Combination Wrench, 12 Pt.	20mm	31-22mm	12 Pt. Standard Metric Socket	22mm	41-29mm	12 Pt. Standard Metric Socket	29mm
11-21mm	Metric Combination Wrench, 12 Pt.	21mm	32-02mm	Metric Hex Bit Socket	2mm	41-30mm	12 Pt. Standard Metric Socket	30mm
11-22mm	Metric Combination Wrench, 12 Pt.	22mm	32-02.5mm	Metric Hex Bit Socket	2.5mm	41-32mm	12 Pt. Standard Metric Socket	32mm
11-23mm	Metric Combination Wrench, 12 Pt.	23mm	32-03mm	Metric Hex Bit Socket	3mm	41-36mm	12 Pt. Standard Metric Socket	36mm
11-24mm	Metric Combination Wrench, 12 Pt.	24mm	32-04mm	Metric Hex Bit Socket	4mm	42-06mm	Hex Bit Socket	6mm
11-25mm	Metric Combination Wrench, 12 Pt.	25mm	32-05mm	Metric Hex Bit Socket	5mm	42-08mm	Hex Bit Socket	8mm
11-26mm	Metric Combination Wrench, 12 Pt.	26mm	32-06mm	Metric Hex Bit Socket	6mm	42-10mm	Hex Bit Socket	10mm
11-27mm	Metric Combination Wrench, 12 Pt.	27mm	32-08mm	Metric Hex Bit Socket	8mm	42-12mm	Hex Bit Socket	12mm
11-30mm	Metric Combination Wrench, 12 Pt.	30mm	32-10mm	Metric Hex Bit Socket	10mm	42-14mm	Hex Bit Socket	14mm
11-32mm	Metric Combination Wrench, 12 Pt.	32mm	3260	Standard Screwdriver Socket with Bit	1/4"	42-17mm	Hex Bit Socket	17mm
11-36mm	Metric Combination Wrench, 12 Pt.	36mm	3262	Standard Screwdriver Socket with Bit	3/8"	4402	2" Extension	
16-11mm	Metric Flare Nut Wrench, 6 Pt.	9mm x 11mm	3266	Phillips Screwdriver Socket with Bit	#2	4405	5" Extension	
16-12mm	Metric Flare Nut Wrench, 6 Pt.	10mm x 12mm	3267	Phillips Screwdriver Socket with Bit	#3	4410	10" Extension	
16-14mm	Metric Flare Nut Wrench, 6 Pt.	13mm x 14mm	3268	Phillips Screwdriver Socket with Bit	#4	4420	20" Extension	
16-17mm	Metric Flare Nut Wrench, 6 Pt.	15mm x 17mm	3402	2" Extension		4426	Ratchet, 10-1/2" Series 400, Knurled Grip	
16-21mm	Metric Flare Nut Wrench, 6 Pt.	19mm x 21mm	3403	3" Extension		4435	Flex Handle, 18" Knurled Steel Grip	
1/4" DRIVE SOCKETS & ATTACHMENTS			3405	5" Extension		4443	Sliding T	
20-04mm	6 Pt. Standard Metric Socket	4mm	3408	8" Extension		4445	Speeder	
20-05mm	6 Pt. Standard Metric Socket	5mm	3412	12" Extension		4453	Adapter, 1/2" F x 3/8" M	
20-06mm	6 Pt. Standard Metric Socket	6mm	3424	24" Extension		4475	Universal	
20-07mm	6 Pt. Standard Metric Socket	7mm	3426	Ratchet, 7" Knurled Grip		4478	Micro-Adjustable Torque Wrench, 30-250 Ft. Lbs.	
20-08mm	6 Pt. Standard Metric Socket	8mm	3435	Flex Handle		46-09mm	12 Pt. Deep Metric Socket	9mm
20-09mm	6 Pt. Standard Metric Socket	9mm	3443	Sliding T		46-10mm	12 Pt. Deep Metric Socket	10mm
20-10mm	6 Pt. Standard Metric Socket	10mm	3445	Speeder, 14-1/2"		46-11mm	12 Pt. Deep Metric Socket	11mm
20-11mm	6 Pt. Standard Metric Socket	11mm	3452	Adapter, 3/8" F x 1/4" M		46-12mm	12 Pt. Deep Metric Socket	12mm
20-12mm	6 Pt. Standard Metric Socket	12mm	3454	Adapter, 3/8" F x 1/2" M		46-13mm	12 Pt. Deep Metric Socket	13mm
20-13mm	6 Pt. Standard Metric Socket	13mm	3475	Universal		46-14mm	12 Pt. Deep Metric Socket	14mm
20-14mm	6 Pt. Standard Metric Socket	14mm	35-06mm	6 Pt. Deep Metric Socket	6mm	46-15mm	12 Pt. Deep Metric Socket	15mm
2402	2" Extension		35-07mm	6 Pt. Deep Metric Socket	7mm	46-16mm	12 Pt. Deep Metric Socket	16mm
2404	4" Extension		35-08mm	6 Pt. Deep Metric Socket	8mm	46-17mm	12 Pt. Deep Metric Socket	17mm
2406	6" Extension		35-09mm	6 Pt. Deep Metric Socket	9mm	46-18mm	12 Pt. Deep Metric Socket	18mm
2410	10" Extension		35-10mm	6 Pt. Deep Metric Socket	10mm	46-19mm	12 Pt. Deep Metric Socket	19mm
2426	Ratchet, 4-3/4"		35-11mm	6 Pt. Deep Metric Socket	11mm	46-20mm	12 Pt. Deep Metric Socket	20mm
2441	Spinner		35-12mm	6 Pt. Deep Metric Socket	12mm	46-21mm	12 Pt. Deep Metric Socket	21mm
2475	Universal Joint		35-13mm	6 Pt. Deep Metric Socket	13mm	46-22mm	12 Pt. Deep Metric Socket	22mm
25-04mm	6 Pt. Deep Metric Socket	4mm	35-14mm	6 Pt. Deep Metric Socket	14mm	46-24mm	12 Pt. Deep Metric Socket	24mm
25-05mm	6 Pt. Deep Metric Socket	5mm	35-15mm	6 Pt. Deep Metric Socket	15mm	46-25mm	12 Pt. Deep Metric Socket	25mm
						46-26mm	12 Pt. Deep Metric Socket	26mm





Part No. Description

SERVICE TOOLS

- 9023 Dead Blow Hammer with Super Grip, 1 Lb.
- 9029 Brass Hammer with Super Grip, 2.5 Lbs.
- 9030 Soft Face Hammer, 12 Oz., 1.25"
- 9040 Ball Peen Hammer, Fiberglass Handle, 8 Oz.
- 9042 Ball Peen Hammer, Fiberglass Handle, 16 Oz.
- 9101 Phillips Screwdriver #2 - 1-1/2"
- 9104 Phillips Screwdriver #1 - 3"
- 9105 Phillips Screwdriver #2 - 4"
- 9106 Phillips Screwdriver #3 - 6"
- 9109 Phillips Screwdriver #4 - 8"
- 9112 Cabinet Tip Screwdriver, 1/8" - 3"
- 9122 Round Shank Screwdriver, 1/4" - 1-1/2"
- 9123 Round Shank Screwdriver, 1/4" - 4"
- 9125 Round Shank Screwdriver, 5/16" - 6"
- 9126 Round Shank Screwdriver, 3/8" - 8"
- 9132 Square Shank Screwdriver, 1/4" - 4"
- 9134 Square Shank Screwdriver, 5/16" - 6"
- 9135 Square Shank Screwdriver, 3/8" - 8"
- 9136 Square Shank Screwdriver, 3/8" - 10"
- 9181 Two-in-One Flip Screwdriver w/Pocket Clip
#1 Phillips and 5/32" Slotted Blades. OAL 4-3/4"
- 9184 Offset Screwdriver, 5/16"
- 9186 Offset Screwdriver, #1 x #2
- 9236 Metric Hollow Shaft Nut Driver, 4mm
- 9237 Metric Hollow Shaft Nut Driver, 4.5mm
- 9238 Metric Hollow Shaft Nut Driver, 5mm
- 9239 Metric Hollow Shaft Nut Driver, 5.5mm
- 9240 Metric Hollow Shaft Nut Driver, 6mm
- 9241 Metric Hollow Shaft Nut Driver, 7mm
- 9242 Metric Hollow Shaft Nut Driver, 8mm
- 9243 Metric Hollow Shaft Nut Driver, 9mm
- 9244 Metric Hollow Shaft Nut Driver, 10mm
- 9245 Metric Hollow Shaft Nut Driver, 11mm
- 9R31020 Ridgid Pipe Wrench, 14"
- 9471 Stripper/Crimper/Cutter, 10-20 AWG
- 9481 Gasket Scraper, Blade Width 1-1/2"
- 9491 Scraper, Stiff Blade, 1-1/4"
- 9520 Hacksaw
- 9526 Utility Knife
- 9530 Feeler Gauge
- 9535 Magnetic Pick-up Tool
- 9576 Punch Bar, 5/8" x 18"
- 9660 Punch & Chisel Kit, 6 Pieces
- 9685 Punch & Chisel Holder
- 9AC06 Adjustable Wrench, 6"
- 9AC08 Adjustable Wrench, 8"
- 9AC10 Adjustable Wrench, 10"
- 9AC12 Adjustable Wrench, 12"
- 9C326 Long Nose Pliers w/Side Cutter, 6"
- 9C347 Linesman Pliers, Round Nose, 7"
- 9C348 Linesman Pliers, Round Nose, 8"
- 9C420 Tongue and Groove Pliers, 9-1/2"
- 9C430 Tongue and Groove Pliers, 10"
- 9C436 Pliers, Box Joint, 6"
- 9C437 Pliers, Box Joint, 7"
- 9C440 Tongue and Groove Pliers, 12"
- 9C526 Slip Joint Pliers Wire Cutting Shears, 6"
- 9G95202 Screw Extractor Set - 5 Pieces
- 9H1234 Retaining Ring Pliers w/Replaceable Tips
- 9P6716S Aviation Snips, Cuts Straight, Yellow, 10"
- 9V10R Straight Jaw Locking Pliers, 10"
- 9V7R Straight Jaw Locking Pliers, 7"
- 9E88061 Hex Key Set, Metric Short Arm, 9 Pieces



▲ WARNING
Wear safety goggles user and bystander.



▲ WARNING
Before using tools, read safety information on pages 399-403.



▲ WARNING
Comfort or plastic grips do not protect against electric shock.



Metric Service Set—1/4", 3/8" & 1/2" Drives

Set No. 194 –
123 Pieces Including WT523
Three Drawer Chest

Set No. 195 –
122 Pieces
(Tools Only - Cabinet Not Included)

See Page 29 for photograph.

Part No.	Description	Size	Part No.	Description	Size
FLAT WRENCHES			3412	12" Extension	
11-09mm	Metric Combination Wrench, 12 Pt.	9mm	3426	Ratchet, 7" Knurled Grip	
11-10mm	Metric Combination Wrench, 12 Pt.	10mm	3435	Flex Handle	
11-11mm	Metric Combination Wrench, 12 Pt.	11mm	3452	Adapter, 3/8" F x 1/4" M	
11-12mm	Metric Combination Wrench, 12 Pt.	12mm	3475	Universal	
11-13mm	Metric Combination Wrench, 12 Pt.	13mm	36-09mm	12 Pt. Deep Metric Socket	9mm
11-14mm	Metric Combination Wrench, 12 Pt.	14mm	36-10mm	12 Pt. Deep Metric Socket	10mm
11-15mm	Metric Combination Wrench, 12 Pt.	15mm	36-11mm	12 Pt. Deep Metric Socket	11mm
11-16mm	Metric Combination Wrench, 12 Pt.	16mm	36-12mm	12 Pt. Deep Metric Socket	12mm
11-17mm	Metric Combination Wrench, 12 Pt.	17mm	36-13mm	12 Pt. Deep Metric Socket	13mm
11-18mm	Metric Combination Wrench, 12 Pt.	18mm	36-14mm	12 Pt. Deep Metric Socket	14mm
11-19mm	Metric Combination Wrench, 12 Pt.	19mm	36-15mm	12 Pt. Deep Metric Socket	15mm
11-20mm	Metric Combination Wrench, 12 Pt.	20mm	1/2" DRIVE SOCKETS & ATTACHMENTS		
11-21mm	Metric Combination Wrench, 12 Pt.	21mm	41-09mm	12 Pt. Standard Metric Socket	9mm
11-22mm	Metric Combination Wrench, 12 Pt.	22mm	41-10mm	12 Pt. Standard Metric Socket	10mm
11-23mm	Metric Combination Wrench, 12 Pt.	23mm	41-11mm	12 Pt. Standard Metric Socket	11mm
11-24mm	Metric Combination Wrench, 12 Pt.	24mm	41-12mm	12 Pt. Standard Metric Socket	12mm
11-25mm	Metric Combination Wrench, 12 Pt.	25mm	41-13mm	12 Pt. Standard Metric Socket	13mm
11-26mm	Metric Combination Wrench, 12 Pt.	26mm	41-14mm	12 Pt. Standard Metric Socket	14mm
11-27mm	Metric Combination Wrench, 12 Pt.	27mm	41-15mm	12 Pt. Standard Metric Socket	15mm
11-30mm	Metric Combination Wrench, 12 Pt.	30mm	41-16mm	12 Pt. Standard Metric Socket	16mm
11-32mm	Metric Combination Wrench, 12 Pt.	32mm	41-17mm	12 Pt. Standard Metric Socket	17mm
11-36mm	Metric Combination Wrench, 12 Pt.	36mm	41-18mm	12 Pt. Standard Metric Socket	18mm
1/4" DRIVE SOCKETS & ATTACHMENTS			41-19mm	12 Pt. Standard Metric Socket	19mm
20-04mm	6 Pt. Standard Metric Socket	4mm	41-20mm	12 Pt. Standard Metric Socket	20mm
20-05mm	6 Pt. Standard Metric Socket	5mm	41-21mm	12 Pt. Standard Metric Socket	21mm
20-06mm	6 Pt. Standard Metric Socket	6mm	41-22mm	12 Pt. Standard Metric Socket	22mm
20-07mm	6 Pt. Standard Metric Socket	7mm	41-23mm	12 Pt. Standard Metric Socket	23mm
20-08mm	6 Pt. Standard Metric Socket	8mm	41-24mm	12 Pt. Standard Metric Socket	24mm
20-09mm	6 Pt. Standard Metric Socket	9mm	41-25mm	12 Pt. Standard Metric Socket	25mm
20-10mm	6 Pt. Standard Metric Socket	10mm	41-26mm	12 Pt. Standard Metric Socket	26mm
20-11mm	6 Pt. Standard Metric Socket	11mm	41-27mm	12 Pt. Standard Metric Socket	27mm
20-12mm	6 Pt. Standard Metric Socket	12mm	41-30mm	12 Pt. Standard Metric Socket	30mm
20-13mm	6 Pt. Standard Metric Socket	13mm	41-32mm	12 Pt. Standard Metric Socket	32mm
20-14mm	6 Pt. Standard Metric Socket	14mm	41-36mm	12 Pt. Standard Metric Socket	36mm
25-04mm	6 Pt. Deep Metric Socket	4mm	4405	5" Extension	
25-05mm	6 Pt. Deep Metric Socket	5mm	4410	10" Extension	
25-06mm	6 Pt. Deep Metric Socket	6mm	4426	Ratchet, 10-1/2" Series 400, Knurled Grip	
25-07mm	6 Pt. Deep Metric Socket	7mm	4435	Flex Handle, 18" Knurled Steel Grip	
25-08mm	6 Pt. Deep Metric Socket	8mm	4475	Universal	
25-09mm	6 Pt. Deep Metric Socket	9mm	SERVICE TOOLS		
25-10mm	6 Pt. Deep Metric Socket	10mm	9032	Soft Face Hammer, 37 Oz., 1.75"	
25-11mm	6 Pt. Deep Metric Socket	11mm	9042	Ball Peen Hammer, Fiberglass Handle, 16 Oz.	
25-12mm	6 Pt. Deep Metric Socket	12mm	9105	Phillips Screwdriver #2 - 4"	
25-13mm	6 Pt. Deep Metric Socket	13mm	9114	Cabinet Tip Screwdriver, 3/16" - 3"	
3/8" DRIVE SOCKETS & ATTACHMENTS			9132	Square Shank Screwdriver, 1/4" - 4"	
30-06mm	6 Pt. Standard Metric Socket	6mm	9134	Square Shank Screwdriver, 5/16" - 6"	
30-07mm	6 Pt. Standard Metric Socket	7mm	9538	Center Punch, 3/8" x 5"	
31-08mm	12 Pt. Standard Metric Socket	8mm	9556	Starter Punch, 3/16" x 5"	
31-09mm	12 Pt. Standard Metric Socket	9mm	9594	Pin Punch, 3/16" x 5-1/4"	
31-10mm	12 Pt. Standard Metric Socket	10mm	9602	Cold Chisel, 3/8" x 5-1/2"	
31-11mm	12 Pt. Standard Metric Socket	11mm	9603	Cold Chisel, 1/2" x 6"	
31-12mm	12 Pt. Standard Metric Socket	12mm	9AC10	Adjustable Wrench, 10"	
31-13mm	12 Pt. Standard Metric Socket	13mm	9C317	Long Nose Pliers w/Side Cutter	
31-14mm	12 Pt. Standard Metric Socket	14mm	9C447	Cutting Pliers, Curved Diagonal, Box Joint, 7-3/4"	
31-15mm	12 Pt. Standard Metric Socket	15mm	9C526	Slip Joint Pliers Wire Cutting Shears, 6"	
31-16mm	12 Pt. Standard Metric Socket	16mm	9E88061	Hex Key Set, Metric Short Arm, 9 Pieces	
31-17mm	12 Pt. Standard Metric Socket	17mm			
31-18mm	12 Pt. Standard Metric Socket	18mm			
31-19mm	12 Pt. Standard Metric Socket	19mm			
3403	3" Extension				
3408	8" Extension				





Metric Apprentice Set—3/8" & 1/2" Drives

Set No. 199 – 75 Pieces Including WT528 Tool Box

See Page 30 for photograph.

Part No.	Description	Size	Part No.	Description
FLAT WRENCHES			4405	5" Extension
11-06mm	Metric Combination Wrench, 12 Pt.	6mm	4426	Ratchet, 10-1/2" Series 400, Knurled Grip
11-07mm	Metric Combination Wrench, 12 Pt.	7mm	4435	Flex Handle, 18" Knurled Steel Grip
11-08mm	Metric Combination Wrench, 12 Pt.	8mm	4475	Universal
11-09mm	Metric Combination Wrench, 12 Pt.	9mm	SERVICE TOOLS	
11-10mm	Metric Combination Wrench, 12 Pt.	10mm	9C526	Slip Joint Pliers Wire Cutting Shears, 6"
11-11mm	Metric Combination Wrench, 12 Pt.	11mm	9E88061	Hex Key Set, Metric Short Arm, 9 Pieces
11-12mm	Metric Combination Wrench, 12 Pt.	12mm	WT52	Tool Box w/Tray
11-13mm	Metric Combination Wrench, 12 Pt.	13mm		
11-14mm	Metric Combination Wrench, 12 Pt.	14mm		
11-15mm	Metric Combination Wrench, 12 Pt.	15mm		
11-16mm	Metric Combination Wrench, 12 Pt.	16mm		
11-17mm	Metric Combination Wrench, 12 Pt.	17mm		
11-18mm	Metric Combination Wrench, 12 Pt.	18mm		
11-19mm	Metric Combination Wrench, 12 Pt.	19mm		
11-20mm	Metric Combination Wrench, 12 Pt.	20mm		
11-21mm	Metric Combination Wrench, 12 Pt.	21mm		
11-22mm	Metric Combination Wrench, 12 Pt.	22mm		
11-23mm	Metric Combination Wrench, 12 Pt.	23mm		
11-24mm	Metric Combination Wrench, 12 Pt.	24mm		
3/8" DRIVE SOCKETS & ATTACHMENTS				
30-06mm	6 Pt. Standard Metric Socket	6mm		
30-07mm	6 Pt. Standard Metric Socket	7mm		
31-08mm	12 Pt. Standard Metric Socket	8mm		
31-09mm	12 Pt. Standard Metric Socket	9mm		
31-10mm	12 Pt. Standard Metric Socket	10mm		
31-11mm	12 Pt. Standard Metric Socket	11mm		
31-12mm	12 Pt. Standard Metric Socket	12mm		
31-13mm	12 Pt. Standard Metric Socket	13mm		
31-14mm	12 Pt. Standard Metric Socket	14mm		
31-15mm	12 Pt. Standard Metric Socket	15mm		
31-16mm	12 Pt. Standard Metric Socket	16mm		
31-17mm	12 Pt. Standard Metric Socket	17mm		
31-18mm	12 Pt. Standard Metric Socket	18mm		
31-19mm	12 Pt. Standard Metric Socket	19mm		
31-20mm	12 Pt. Standard Metric Socket	20mm		
31-21mm	12 Pt. Standard Metric Socket	21mm		
31-22mm	12 Pt. Standard Metric Socket	22mm		
3405	5" Extension			
3426	Ratchet, 7" Knurled Grip			
1/2" DRIVE SOCKETS & ATTACHMENTS				
41-09mm	12 Pt. Standard Metric Socket	9mm		
41-10mm	12 Pt. Standard Metric Socket	10mm		
41-11mm	12 Pt. Standard Metric Socket	11mm		
41-12mm	12 Pt. Standard Metric Socket	12mm		
41-13mm	12 Pt. Standard Metric Socket	13mm		
41-14mm	12 Pt. Standard Metric Socket	14mm		
41-15mm	12 Pt. Standard Metric Socket	15mm		
41-16mm	12 Pt. Standard Metric Socket	16mm		
41-17mm	12 Pt. Standard Metric Socket	17mm		
41-18mm	12 Pt. Standard Metric Socket	18mm		
41-19mm	12 Pt. Standard Metric Socket	19mm		
41-20mm	12 Pt. Standard Metric Socket	20mm		
41-21mm	12 Pt. Standard Metric Socket	21mm		
41-22mm	12 Pt. Standard Metric Socket	22mm		
41-23mm	12 Pt. Standard Metric Socket	23mm		
41-24mm	12 Pt. Standard Metric Socket	24mm		
41-25mm	12 Pt. Standard Metric Socket	25mm		
41-26mm	12 Pt. Standard Metric Socket	26mm		
41-27mm	12 Pt. Standard Metric Socket	27mm		
41-30mm	12 Pt. Standard Metric Socket	30mm		
41-32mm	12 Pt. Standard Metric Socket	32mm		
41-36mm	12 Pt. Standard Metric Socket	36mm		



NEW! Adjustable Wrenches

BETTER DESIGN, BETTER PERFORMANCE

Available in 7 Sizes (4" to 18") Chrome and Black Finishes

Lower jaw clearance helps avoid slippage on nuts/bolts and round-off nut corners

Thinner jaws provide better accessibility

Improved jaw capacity (on 6", 8", 10" and 12")

Improved torque

Longer jaws facilitate full accommodation of bigger nuts and bolts

Unique 4-thread knurl has +33% worm resistance and improved, better-balanced design (on 6", 8", 10" and 12")

Improved performance in confined spaces

Non-protruding jaw shank, despite wider opening

Available on 6", 8", 10" and 12"

Fully compliant with ASME B107.8-2003 Standard (Type 2)



	L		A Max. Jaw Opening		B	S	T	U		Weight lbs.
	in.	mm	in.	mm				Min.	Max.	
9AC04 9AB04	4	114.0	1/2	13.0	1-3/8	3/8	3/16	1/4	1/4	0.115
9AC06 9AB06	6	161.0	15/16	24.0	2	7/16	3/16	5/16	3/8	0.287
9AC08 9AB08	8	206.5	1-1/8	28.5	2-7/16	9/16	1/4	3/8	3/8	0.584
9AC10 9AB10	10	257.5	1-3/8	34.0	2-7/8	5/8	5/16	7/16	1/2	0.937
9AC12 9AB12	12	310.5	1-1/2	38.1	3-5/16	3/4	3/8	1/2	9/16	1.554
9AC15 9AB15	15	386.0	1-11/16	43.12	4-3/16	1	9/16	9/16	5/8	2.910
9AC18 9AB18	18	462.0	2-1/8	53.0	4-7/8	1-3/16	5/8	5/8	11/16	4.497

09AC Chrome-Plated Finish, Right Turning
09AB Phosphate Finish, Right Turning





Conversion Chart Showing Millimeter Sizes, Fractional and Decimal Inch Sizes

Milli-Meter	Dec. Equiv.	Frac-tional	Milli-Meter	Dec. Equiv.	Frac-tional	Milli-Meter	Dec. Equiv.	Frac-tional	Milli-Meter	Dec. Equiv.	Frac-tional
.1	.0039		1.1	.0433	0960		4.1	.1614	
.15	.0059		1.15	.0452		2.45	.0964		4.2	.1654	
.2	.0079	0465	0980	1660	
.25	.0098		1.19	.0469	3/64"	2.5	.0984		4.25	.1673	
.3	.0118		1.2	.0472	0995		4.3	.1693	
....	.0135		1.25	.0492	1015	1695	
.35	.0138		1.3	.0512		2.6	.1024		4.37	.1719	11/64"
....	.0145	0520	1040	1730	
.39	.0156	1/64"	1.35	.0531		2.7	.1063		4.4	.1732	
.4	.0157	0550	1065	1770	
....	.0160		1.4	.0551		2.75	.1082		4.5	.1771	
.45	.0177		1.45	.0570		2.78	.1094	7/64"1800	
....	.0180		1.5	.0591	1100		4.6	.1811	
.5	.0197	0595		2.8	.1102	1820	
....	.0200		1.55	.0610	1110		4.7	.1850	
....	.0210		1.59	.0625	1/16"1130		4.75	.1870	
.55	.0217		1.6	.0629		2.9	.1141		4.76	.1875	3/16"
....	.0225	0635	1160		4.8	.1890	
.6	.0236		1.65	.0649		3.0	.1181	1910	
....	.0240		1.7	.0669	1200		4.9	.1929	
....	.0250	0670		3.1	.1220	1935	
.65	.0256		1.75	.0689		3.18	.1250	1/8"1960	
....	.0260	0700		3.2	.1260		5.0	.1968	
....	.0280		1.8	.0709		3.25	.1279	1990	
.7	.0276		1.85	.0728	1285		5.1	.2008	
....	.0292	0730		3.3	.1299	2010	
.75	.0295		1.9	.0748		3.4	.1338		5.16	.2031	13/64"
....	.0310	0760	1360	2040	
.79	.0312	1/32"	1.95	.0767		3.5	.1378		5.1	.2047	
.8	.0315		1.98	.0781	5/64"1405	2055	
....	.0320	0785		3.57	.1406	9/64"	5.25	.2067	
....	.0330		2.0	.0787		3.6	.1417		5.3	.2086	
.85	.0335		2.05	.0807	1440	2090	
....	.0350	0810		3.7	.1457		5.4	.2126	
.9	.0354	0820	1470	2130	
....	.0360		2.1	.0827		3.75	.1476		5.5	.2165	
....	.0370		2.15	.0846	1495		5.56	.2187	7/32"
.95	.0374	0860		3.8	.1496		5.6	.2205	
....	.0380		2.2	.0866	1520	2210	
....	.0390		2.25	.0885		3.9	.1535		5.7	.2244	
1.0	.0394	0890	1540		5.75	.2263	
....	.0400		2.3	.0905		3.97	.1562	5/32"2280	
....	.0410		2.35	.0925	1570		5.8	.2283	
1.05	.0413	0935		4.0	.1575		5.9	.2323	
....	.0420		2.38	.0937	3/32"1590	2340	
....	.0430		2.4	.0945	1610		5.95	.2344	15/64"





Conversion Chart Showing Millimeter Sizes, Fractional and Decimal Inch Sizes

Milli-Meter	Dec. Equiv.	Frac-tional	Milli-Meter	Dec. Equiv.	Frac-tional	Milli-Meter	Dec. Equiv.	Frac-tional	Milli-Meter	Dec. Equiv.	Frac-tional
6.0	.2362	3230		12.0	.4724		22.23	.8750	7/8"
....	.2380		8.25	.3248		12.30	.4843	31/64"	22.5	.8858	
6.1	.2401		8.3	.3268		12.5	.4921		22.62	.8906	57/64"
....	.2420		8.33	.3281	21/64"	12.7	.5000	1/2"	23.0	.9055	
6.2	.2441		8.4	.3307		13.0	.5118		23.02	.9062	29/32"
6.25	.2460	3320		13.10	.5156	33/64"	23.42	.9219	59/64"
6.3	.2480		8.5	.3346		13.49	.5312	17/32"	23.5	.9252	
6.35	.2500	1/4"	8.6	.3386		13.5	.5315		23.81	.9375	15/16"
6.4	.2520	3390		13.89	.5469	35/64"	24.0	.9449	
6.5	.2559		8.7	.3425		14.0	.5512		24.21	.9531	61/64"
....	.2570		8.73	.3437	11/32"	14.29	.5625	9/16"	24.5	.9646	
6.6	.2598		8.75	.3445		14.5	.5709		24.61	.9687	31/32"
....	.2570		8.8	.3465		14.68	.5781	37/64"	25.0	.9843	
6.6	.2598	3480		15.0	.5906		25.03	.9844	63/64"
....	.2610		8.9	.3504		15.08	.5937	19/32"	25.4	1.000	1"
6.7	.2638		9.0	.3543		15.48	.6094	39/64"			
6.75	.2656	17/64"3580		15.5	.6102				
6.75	.2657		9.1	.3583		15.88	.6250	5/8"			
....	.2660		9.13	.3594	23/64"	16.0	.6299				
6.8	.2677		9.2	.3622		16.27	.6406	41/64"			
6.9	.2716		9.25	.3641		16.5	.6496				
....	.2720		9.3	.3661		16.67	.6562	21/32"			
7.0	.2756	3680		17.0	.6693				
....	.2770		9.4	.3701		16.06	.6719	43/64"			
7.1	.2795		9.5	.3740		16.46	.6875	11/16"			
....	.2811		9.53	.3750	3/8"	17.5	.6890				
7.14	.2812	9/32"3770		17.86	.7031	45/64"			
7.2	.2835		9.6	.3780		18.0	.7087				
7.25	.2854		9.7	.3819		18.26	.7187	23/32"			
7.3	.2874		9.75	.3838		18.5	.7283				
....	.2900		9.8	.3858		18.65	.7344	47/64"			
7.4	.2913	3860		19.0	.7480				
....	.2950		9.9	.3898		19.05	.7500	3/4"			
7.5	.2953		9.92	.3906	25/64"	19.45	.7656	49/64"			
7.54	.2968	19/64"	10.0	.3937		19.5	.7677				
7.6	.2992	3970		19.84	.7812	25/32"			
....	.3020	4040		20.0	.7874				
7.7	.3031		10.32	.4062	13/32"	20.24	.7969	51/64"			
7.75	.3051	4130		20.5	.8071				
7.8	.3071		10.5	.4134		20.64	.8125	13/16"			
7.9	.3110		10.72	.4219	27/64"	21.0	.8268				
7.94	.3125	5/16"	11.0	.4330		21.03	.8281	53/64"			
8.0	.3150		11.11	.4375	7/16"	21.43	.8437	27/32"			
....	.3160		11.5	.4528		21.5	.8465				
8.1	.3189		11.51	.4531	29/64"	21.83	.8594	55/64"			
8.2	.3228		11.91	.4687	15/32"	22.0	.8661				





Nominal Opening Sizes of Wright Wrenches or Sockets in Inches to Fit Standard Bolt Heads, Nuts and Screw Heads

Locate thread diameter of bolt, nut or screw in extreme left or right column. Then move across to box which has proper identification of bolt, nut or screw at top of vertical column. The size in this particular box is the nominal opening size in inches of the Wright Tool wrenches and sockets that will fit.

Nuts					Bolts and Screws				
Thread Diameter of Nut	Finished Series And Finished Thick Nuts	Regular Series Hex And Square Nuts	Heavy Series Hex And Square Nuts	Machine Screw Nuts And Stove Bolt Nuts	Regular And Finished Series Hex And Square Head Bolts	Heavy Series Hex And Square Bolts	Lag Screws	Square Head Set Screws	Thread Diameter of Bolt or Screw
		Use wrench or socket size shown below				Use wrench or socket size shown below			
#0 & 1				5/32"					#0 & 1
#2 & 3				3/16"					#2 & 3
#4				1/4"					#4
#5 & 6				5/16"					#5 & 6
#8				11/32"					#8
#10				3/8"			5/16"	3/16"	#10
#12				7/16"				7/32"	#12
1/4"	7/16"	7/16"	1/2"	7/16"	3/8"-7/16"*		3/8"	1/4"	1/4"
5/16"	1/2"	9/16"	9/16"	9/16"	1/2"		1/2"	5/16"	5/16"
3/8"	9/16"	5/8"	11/16"	5/8"	9/16"		9/16"	3/8"	3/8"
7/16"	11/16"	3/4"	3/4"		5/8"		5/8"	7/16"	7/16"
1/2"	3/4"	13/16"	7/8"		3/4"	7/8"	3/4"	1/2"	1/2"
9/16"	7/8"	7/8"	15/16"		13/16"			9/16"	9/16"
5/8"	15/16"	1"	1-1/16"		15/16"	1-1/16"	15/16"	5/8"	5/8"
3/4"	1-1/8"	1-1/8"	1-1/4"		1-1/8"	1-1/4"	1-1/8"	3/4"	3/4"
7/8"	1-5/16"	1-5/16"	1-7/16"		1-5/16"	1-7/16"	1-5/16"	7/8"	7/8"
1"	1-1/2"	1-1/2"	1-5/8"		1-1/2"	1-5/8"	1-1/2"	1"	1"
1-1/8"	1-11/16"	1-11/16"	1-13/16"		1-11/16"	1-13/16"	1-11/16"	1-1/8"	1-1/8"
1-1/4"	1-7/8"	1-7/8"	2"		1-7/8"	2"	1-7/8"	1-1/4"	1-1/4"
1-3/8"	2-1/16"	2-1/16"	2-3/16"		2-1/16"	2-3/16"		1-3/8"	1-3/8"
1-1/2"	2-1/4"	2-1/4"	2-3/8"		2-1/4"	2-3/8"		1-1/2"	1-1/2"
1-5/8"	2-7/16"	2-7/16"	2-9/16"		2-7/16"	2-9/16"			1-5/8"
1-3/4"	2-5/8"	2-5/8"	2-3/4"		2-5/8"	2-3/4"			1-3/4"
1-7/8"	2-13/16"	2-13/16"	2-15/16"		2-13/16"	2-15/16"			1-7/8"
2"	3"	3"	3-1/8"			3"	3-1/8"		2"
2-1/4"	3-3/8"	3-3/8"	3-1/2"		3-3/8"	3-1/2"			2-1/4"
2-1/2"	3-3/4"	3-3/4"	3-7/8"		3-3/4"	3-7/8"			2-1/2"
2-3/4"	4-1/8"	4-1/8"	4-1/4"		4-1/8"	4-1/4"			2-3/4"
3"	4-1/2"	4-1/2"	4-5/8"		4-1/2"	4-5/8"			3"
3-1/4"			5"		4-7/8"				3-1/4"
3-1/2"			5-3/8"		5-1/4"				3-1/2"
3-3/4"			5-3/4"		5-5/8"				3-3/4"
4"			6-1/8"		6"				4"

* Regular Square Bolts Only.





Make Sure to Use the Right Drive

Wrench Size				Wrench Size				Wrench Size				Wrench Size			
inch		metric		inch		metric		inch		metric		inch		metric	
		Min. Opening				Min. Opening				Min. Opening				Min. Opening	
		Drive				Drive				Drive				Drive	
		mm				mm				mm				mm	
		inches				inches				inches				inches	
3/16	4mm	4.0	1/4	11/16	17.5			1-5/16	32mm	32.0	3/4	2-3/16	55mm	55.0	
		4.8	1/4			18mm	18.0				33mm		33.0	3/4	
7/32	5mm	5.0	1/4	3/4	19.0			1-3/8	34mm	33.3	3/4	2-1/4	56mm	56.0	
		5.5	1/4			19mm	19.1				34mm		34.0	3/4	
1/4	6mm	6.0	1/4	25/32	19.8			1-7/16	35mm	34.9	3/4	2-5/16	58mm	58.0	
		6.3	1/4			20mm	20.0				35mm		35.0		
9/32	7mm	7.0	1/4	13/16	20.6	1/2		1-1/2	36mm	36.0		2-3/8	60mm	60.0	
		7.1	1/4			21mm	21.0		1/2		36mm		36.5		
5/16	7mm	7.1	1/4	7/8	22.2	1/2		1-9/16	38mm	38.0		2-7/16	61.9	61.9	
		7.9	1/4			22mm	22.0		1/2		38mm		38.1	1	
11/32	8mm	8.0	1/4	29/32	23.0	1/2		1-5/8	41mm	39.7	1	2-1/2	65mm	65.0	
		8.7	1/4			23mm	23.0		1/2		41mm		41.0	1	
3/8	9mm	9.0	1/4	15/16	23.8	1/2		1-11/16	42mm	41.3	1	2-5/8	66.7	66.7	1-1/2
		9.5	1/4			24mm	24.0		1/2		42mm		42.0	1	
7/16	10mm	10.0	1/4	31/32	24.6	1/2		1-3/4	43mm	42.9	1	2-11/16	69.9	69.9	1-1/2
		11.0	3/8			24mm	24.6		1/2		43mm		43.0	1	
1/2	11mm	11.1	3/8	1	25.0	1/2		2-1/8	44.5	44.5	1	2-13/16	71.4	71.4	1-1/2
		12.0	3/8			25mm	25.4		1/2		44.5		44.5	1	
9/16	12mm	12.0	3/8	1-1/16	26.0			1-13/16	46mm	46.0	1	2-7/8	74.6	74.6	1-1/2
		12.7	3/8			26mm	26.0				46mm		46.0	1	
5/8	13mm	13.0	3/8	27mm	27.0			1-7/8	47.6	47.6	1	2-15/16	76.2	76.2	1-1/2
		14.0	3/8			27mm	27.0				47.6		47.6	1	
21/32	14mm	14.0	3/8	1-1/8	28.0	3/4		1-15/16	49.2	49.2	1	3	79.4	79.4	1-1/2
		14.3	3/8			28mm	28.0		3/4		49.2		49.2	1	
19/32	15mm	15.0		29mm	29.0	3/4		2	50mm	50.0	1	3-1/8	82.6	82.6	1-1/2
		15.1				29mm	29.0		3/4		50mm		50.8	1	
5/8	15mm	15.1		30mm	30.0	3/4		2-1/16	52mm	52.0		3-1/4	88.9	88.9	1-1/2
		15.9				30mm	30.0		3/4		52mm		52.0		
21/32	16mm	16.0		1-3/16	30.2	3/4		2-1/8	52.4	52.4		3-3/8			
		16.7				31mm	31.0		3/4		52.4		52.4		
	17mm	17.0		1-1/4	31.8	3/4		54mm	54.0	54.0		3-1/2			
	17mm	17.0				31mm	31.0		3/4		54mm		54.0		

Use this table to select the correct size wrench for any size fastener—inch or metric.

1. Measure the fastener head or nut with metric calipers.
2. Look down the MINIMUM OPENING column and find the first number larger than your reading.
3. Look to the left of that number to find the wrench size. (The vertical line between two sizes indicates that the range of an inch wrench overlaps that of a metric wrench. Either size can often be used.)

This table is to help you select the correct size wrench for any fastener, even if you do not know whether it is an inch or a metric fastener. The closer a wrench fits a fastener, the more torque can be transmitted without rounding the fastener corners or causing excessive wear to the wrench.

First, measure the fastener head or nut with calipers in millimeters. Then, look down the MINIMUM OPENING column to find the first number larger than your reading. For example, if you read 15.1, look down the table until you come to the value 15.9; then look across the table to 5/8". The vertical line between two sizes indicates that the range of an inch wrench overlaps that of a metric wrench. Either size can often be used.

However, the table can also be used to find the best possible fit. A 16mm wrench could be used, but 5/8" provides a better fit in this example. If you read 31.8, you may either use the table or recognize that this is very close

to, but slightly smaller than 32mm. Therefore, you can safely use a 32mm wrench without referring to the table.

Another way to use the table without measuring is to simply choose a wrench and try it. If the wrench is "sloppy loose," choose a smaller wrench. Use the table to find the next size wrench, either inch or metric. If the wrench doesn't fit, then you need to select a larger wrench. Again, use the table to see which is the next larger wrench in either the inch or metric size.

Sometimes, a fastener is damaged or worn, so you might need to use a slightly different size wrench. You can always use the table to come as close as possible to the best fit. Always feel how much play there is to see that you have made the correct choice. If it doesn't feel right, it isn't right.

Remember that all wrenches wear when they are used, even when they are used carefully. Once a wrench is worn oversize, it should be discarded because its use would be the same as putting the wrong size wrench on a fastener.

The best drive size is indicated in the column headed BEST DRIVE. The drive indicated here provides an appropriately high level of strength in the handle. If you use a smaller drive than what is recommended here, you may not have a strong enough tool for high-strength applications. If you are using soft fasteners, a smaller drive will work satisfactorily. If no drive is listed, use your judgement for the job. Extremely high torque may require an even larger drive size than indicated.





Ret Ring Interchange

A Groove Diameter Socket Size	B For Use On Square Drive	Number On Ring	Wright	FTL	Armstrong	ATP	CP	Proto	IR	Williams
1-1/4"	3/4"	10005S	6580	FTL10005S		ATP10005S	C155467		IR10005S	
1-7/16"	3/4"	10032S	6581	FTL10032S	21-964	ATP10032S	C155468	07500-0	IR10032S	6-1X
1-5/8"	3/4"	10034S	6582	FTL10034S	21-965	ATP10034S	C134690	07500-1	IR10034S	6-2X
1-3/4"	3/4"	18708S	6582A	FTL18708S		ATP18708S	C134691			
2"	3/4"	18710S	6582C	FTL18710S		ATP18710S	C155585			
2-1/8"	3/4"	18715S	6582B	FTL18715S		ATP18715S	C155489			
2-1/4"	3/4"	18716S	6582D	FTL18716S		ATP18716S	C155586			
1-3/4"	1"	10008S	6583	FTL10008S	21-967	ATP10008S	C155470	10000-3	IR10008S	7-1X
2"	1"	10010S	6581A	FTL10010S	22-964	ATP10010S	C155471	10000-1	IR10010S	7-2X
2-1/8"	1"	10015S	6584	FTL10015S	22-965	ATP10015S	C155472	10000-2	IR10015S	7-3X
2-1/4"	1"	10016S	6585	FTL10016S		ATP10016S	C134692	10000-4		
2-1/2"	1"	10019S	6586	FTL10017S		ATP10017S	C155473	12500-1	IR10017S	7-4X
2-5/8"	1"	18020S	6587	FTL10019S		ATP10019S	C155474		IR10019S	7-5X
2-7/8"	1-1/2"	10020S	84575	FTL10020S	23-964	ATP10020S	C134693	15000-1	IR10020S	8-1X
3-3/8"	1-1/2"	10025S	84576	FTL10025S		ATP10025S	C134694	15000-2	IR10025S	8-2X
3-7/8"	1-1/2"	10030S	84577	FTL10030S		ATP10030S	C134695	15000-3	IR10030S	8-3X
4-3/8"	1-1/2"	10035S	84578	FTL10035S		ATP10035S	C134696	15000-4	IR10035S	8-4X

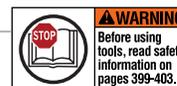

DISPLAY BOARDS



Wright Tool offers a wide selection of display boards

to help you show and sell Wright products. There's a

display board for virtually every product category, as

well as modular boards and components that let you

customize your tool offering.

DISPLAY BOARDS.



DISPLAY BOARDS

ASME B107.100 – Flat Wrenches

ASME B107.110 – Socket Wrenches

ASME B107.400 – Striking Tools/Hammers

ASME B107.500 – Pliers

ASME B107.510 – Pliers and Shears



Flat Wrenches

WRIGHT TOOL
PERFECTING PERFORMANCE



Fractional Combination Wrenches **WRIGHTGrip**
D977 – 17 Pieces, Satin Wrenches
D978 – 17 Pieces, Full Polish Wrenches
D941B – Board Only See Page 377 for contents.

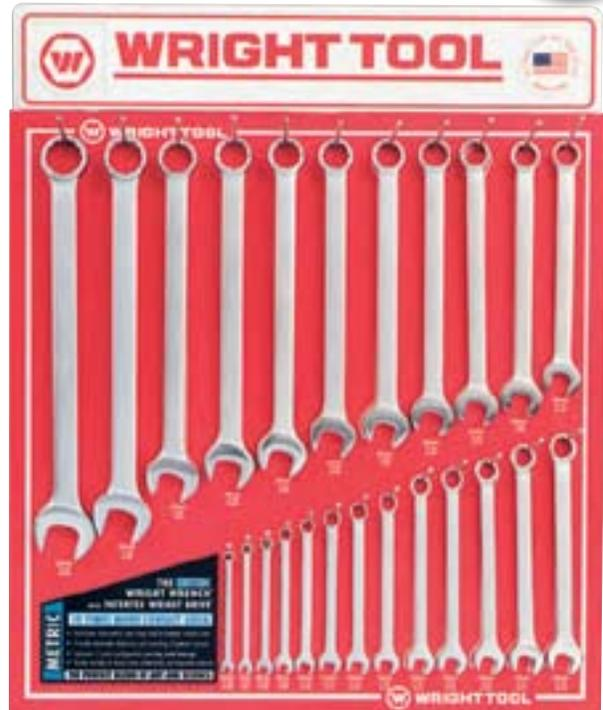

Metric Combination Wrenches
D979 – 24 Pieces, Satin Wrenches
D980 – 24 Pieces, Full Polish Wrenches
D955B – Board Only See Page 377 for contents.



Fractional Double Box End Wrenches
D942 – 15 Pieces, 12 Point
 See Page 377 for contents.



Fractional Open End Wrenches
D987 – 18 Pieces
 See Page 377 for contents.

NOTE: Wright Tool Display Board measures 24" x 24" (unless otherwise specified). Wright Tool Display Header measures 24" x 5"



www.wrighttool.com

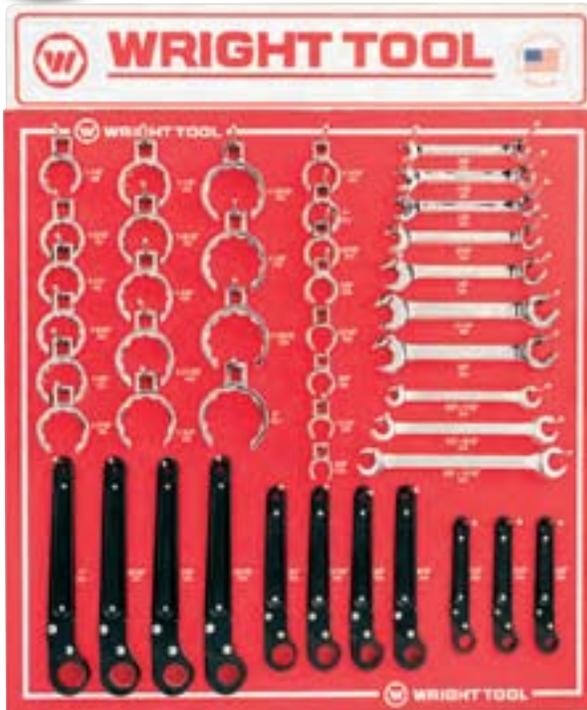

Fractional Tubing Wrenches

D981 – 44 Pieces

See Page 378 for contents.

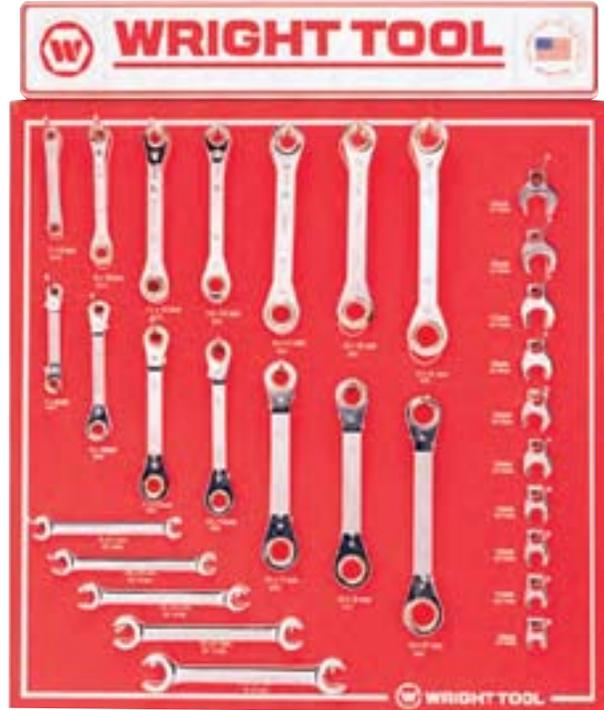

Metric Wrenches

D956 – 29 Pieces, Ratcheting Box Wrenches, Flare Nut Wrenches & Crowfoot Wrenches

See Page 378 for contents.



Fractional Service Wrenches

D943 – 22 Pieces

See Page 378 for contents.



Salesmen's Sample Case

D940 – 34 Pieces

See Page 379 for contents.



Adjustable Wrenches

WRIGHT TOOL
PERFECTING PERFORMANCE



Adjustable Wrenches

D975 – 30 Pieces, 6 each size, 12" Wide Display

See Page 379 for contents.



Adjustable Wrenches

D976 – 30 Pieces, 6 each size, 12" Wide Display

See Page 379 for contents.

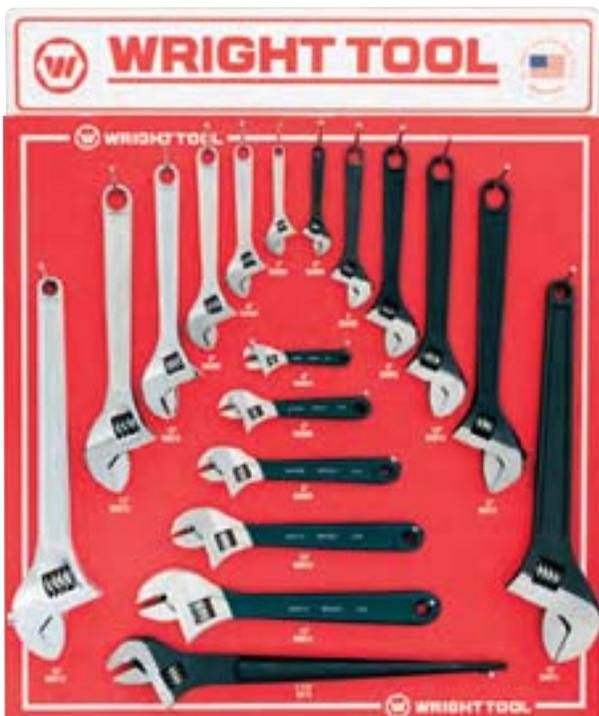

Adjustable Wrenches

D961 – 18 Pieces

See Page 379 for contents.



Ridgid Pipe Wrenches

D972 – 6 Pieces

See Page 379 for contents.

RIDGID



www.wrighttool.com

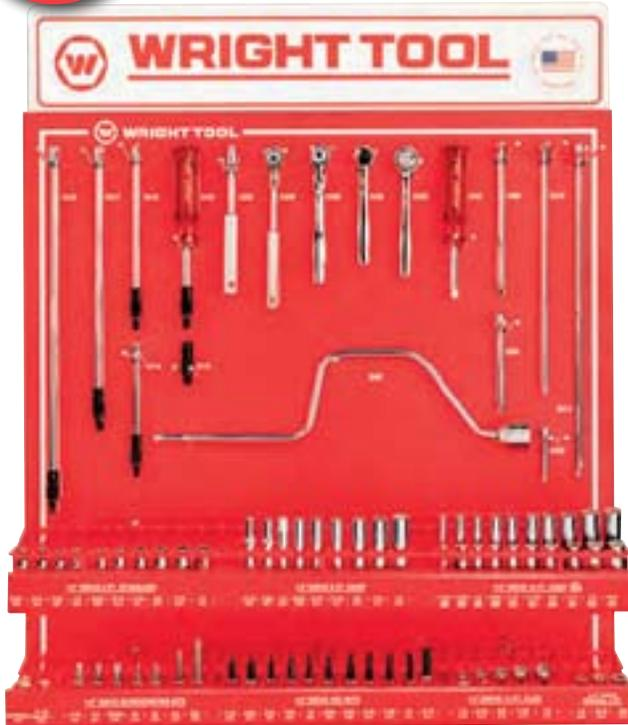

Fractional Sockets, Handles & Attachments
D982 – 85 Pieces, 1/4" Drive 6 & 12 Pt. Sockets, Handles & Attachments
See Page 380 for contents.



Metric Sockets
D957 – 78 Pieces, 1/4" & 3/8" Drive 6 & 12 Pt. Sockets
See Page 380 for contents.

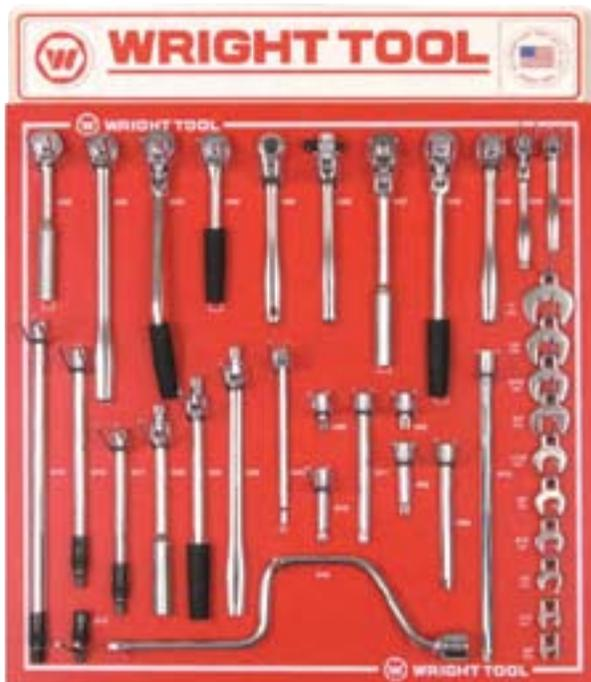

Fractional Handles & Attachments
D983 – 37 Pieces, 3/8" Drive Handles & Attachments
See Page 381 for contents.



Fractional Sockets
D984 – 91 Pieces, 3/8" Drive 6 & 12 Pt. Sockets
See Page 381 for contents.





Fractional Handles & Attachments
D946 – 18 Pieces, 1/2" Drive Handles & Attachments

See Page 382 for contents.



Fractional Standard & Deep Sockets
D947 – 61 Pieces, 1/2" Drive 6 Pt. Standard & Deep Sockets

See Page 382 for contents.



Fractional Standard & Deep Sockets
D948 – 40 Pieces, 1/2" Drive 12 Pt. Standard & Deep Sockets

See Page 382 for contents.



Metric Sockets
D958 – 61 Pieces, 1/2" & 3/4" Drive 12 Pt. Sockets

See Page 383 for contents.



WARNING
Wear safety goggles user and bystander.



WARNING
Before using tools, read safety information on pages 399-403.



WARNING
Comfort or plastic grips do not protect against electric shock.



Fractional Sockets, Handles & Attachments
D949 – 16 Pieces, 3/4" Drive 12 Pt. Sockets, Handles & Attachments

See Page 383 for contents.



Fractional Sockets, Handles & Attachments
D951 – 24 Pieces, 1" Drive 12 Pt. Standard Sockets, Handles & Attachments
D952 – 13 Pieces, 1" Drive 12 Pt. Standard Sockets, Handles & Attachments

See Page 384 for contents.



Fractional Standard & Deep Sockets
D950 – 30 Pieces, 3/4" Drive 12 Pt. Standard & Deep Sockets

See Page 383 for contents.

www.wrighttool.com

Display Boards





Fractional Impact Sockets & Attachments
D953 – 55 Pieces, 1/2" Drive 6 & 12 Pt. Std. & Deep Impact Sockets & Attachments

See Page 384 for contents.



"These Wright Tool display boards are a terrific sales tool; they show my customers just how many different tools there are in the Wright line. And since I've put them up, sales have gone through the roof."

*Tricor Industrial,
Wooster, OH*



Fractional Impact Sockets & Attachments
D985 – 44 Pieces, 3/4" Drive 6 & 12 Pt. Standard Impact Sockets & Attachments

See Page 385 for contents.



Fractional Deep Impact Sockets
D986 – 33 Pieces, 3/4" Drive 6 & 12 Pt. Deep Impact Sockets

See Page 385 for contents.





Metric Impact Sockets
D959 – 94 Pieces, 3/8" & 1/2" Drive 6 Pt. Standard & Deep Impact Sockets
See Page 386 for contents.



Metric Impact Sockets
D960 – 43 Pieces, 3/4" Drive 6 Pt. Standard & Deep Impact Sockets
See Page 386 for contents.

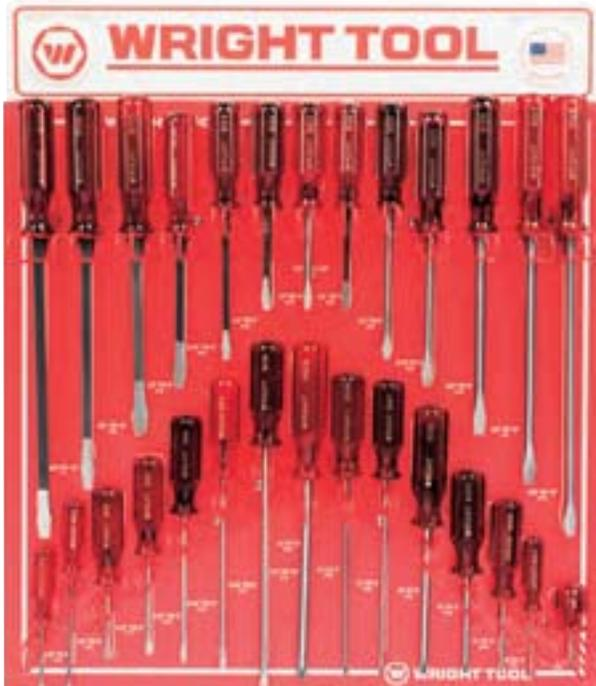

Screwdrivers
D973 – 28 Pieces, Jumbo Three-flute Ergonomic Handle
See Page 387 for contents.

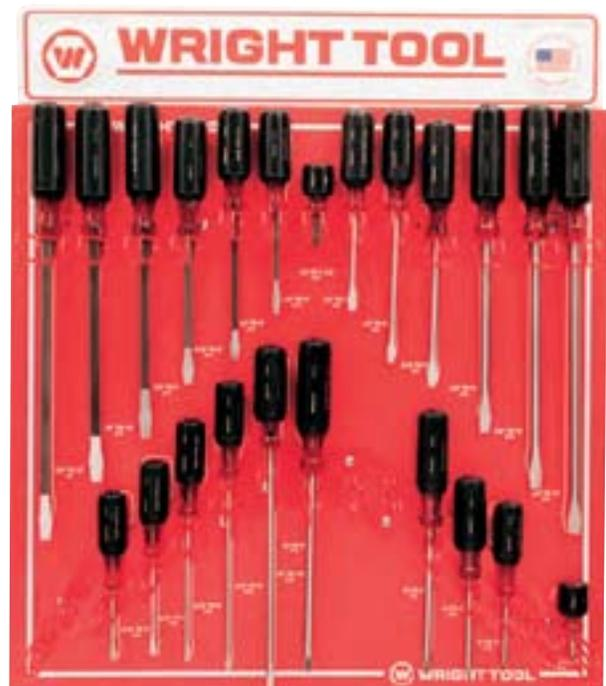

Screwdrivers
D974 – 23 Pieces, Large Cushion Grip Handle
See Page 387 for contents.



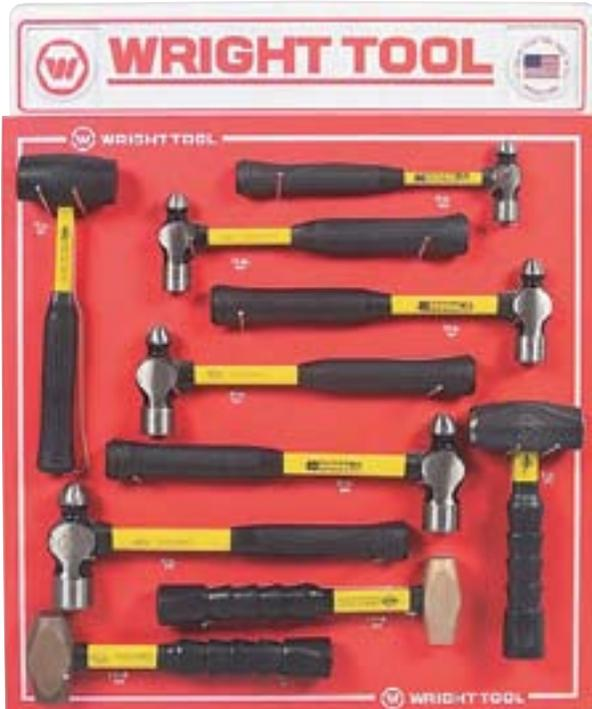

Hammers

D962 – 10 Pieces, Nupla® Hammers

See Page 387 for contents.



Hammers

D963 – 7 Pieces, Nupla® Hammers

See Page 387 for contents.



Pliers

D969 – 10 Pieces, Channellock® Pliers

See Page 387 for contents.



Pliers

D970 – 9 Pieces, Channellock® Pliers

See Page 388 for contents.





Vise Grip®
D965 – 6 Pieces
See Page 388 for contents.

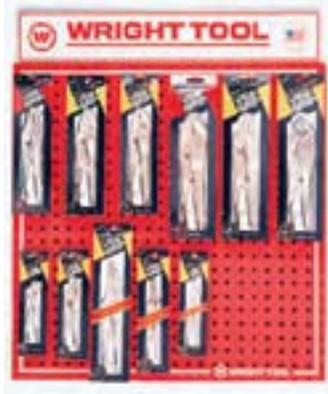

Vise Grip®
D966 – 11 Pieces
See Page 388 for contents.



Midwest®/Hyde®
D967 – 9 Pieces
See Page 388 for contents.



Torx Bits, Sockets & Hex Key Sets
D968 – 31 Pieces
See Page 388 for contents.

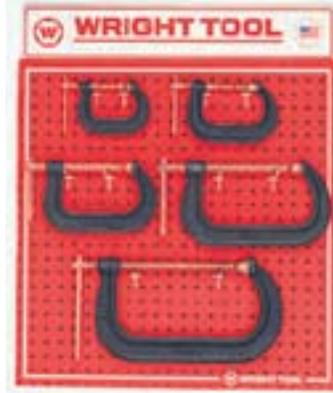

C-Clamps
D971 – 5 Pieces
See Page 388 for contents.



Display Board Contents

The socket portion of the Wright Tool selling displays are modular. The components listed below are available to customize your tool offering.

Includes:

- (A) **D938B** – display board includes 24" x 5" header and 24" x 24" peg board
- (B) **D938Bracket** – clips to attach trays to pegboard (1 pair)
- (C) **D938Leg** – allow board to stand on counter or shelf
- (D) **D938FOUR** – socket divider for 4" tray (1)
D938SIX – socket divider for 6" tray (1)
- (E) **D938TRAY4SH** – 4" tray for 1/4" drive sockets, shown
- (F) **D938TRAY4ST** – 4" tray for all drive size sockets, not shown
- (G) **D938TRAY6ST** – 6" tray for all drive size sockets
- (H) **D938HEADER** – 24" x 5" header
- (I) **D971HOOK** – 4-1/2" metal hook (pack of 10)





Fractional Combination Wrenches

D977 – 17 Pieces, Satin Wrenches

D978 – 17 Pieces, Full Polish Wrenches

See Page 367 for photograph.

Part No.	Description	Size	Part No.	Description	Size	Part No.	Description	Size
D977			1130	Combination Wrench, 12 Pt.	15/16"	1218	Combination Wrench, 12 Pt.	9/16"
1108	Combination Wrench, 12 Pt.	1/4"	1132	Combination Wrench, 12 Pt.	1"	1220	Combination Wrench, 12 Pt.	5/8"
1110	Combination Wrench, 12 Pt.	5/16"	1134	Combination Wrench, 12 Pt.	1-1/16"	1222	Combination Wrench, 12 Pt.	11/16"
1112	Combination Wrench, 12 Pt.	3/8"	1136	Combination Wrench, 12 Pt.	1-1/8"	1224	Combination Wrench, 12 Pt.	3/4"
1114	Combination Wrench, 12 Pt.	7/16"	1138	Combination Wrench, 12 Pt.	1-3/16"	1226	Combination Wrench, 12 Pt.	13/16"
1116	Combination Wrench, 12 Pt.	1/2"	1140	Combination Wrench, 12 Pt.	1-1/4"	1228	Combination Wrench, 12 Pt.	7/8"
1118	Combination Wrench, 12 Pt.	9/16"	D978			1230	Combination Wrench, 12 Pt.	15/16"
1120	Combination Wrench, 12 Pt.	5/8"	1208	Combination Wrench, 12 Pt.	1/4"	1232	Combination Wrench, 12 Pt.	1"
1122	Combination Wrench, 12 Pt.	11/16"	1210	Combination Wrench, 12 Pt.	5/16"	1234	Combination Wrench, 12 Pt.	1-1/16"
1124	Combination Wrench, 12 Pt.	3/4"	1212	Combination Wrench, 12 Pt.	3/8"	1236	Combination Wrench, 12 Pt.	1-1/8"
1126	Combination Wrench, 12 Pt.	13/16"	1214	Combination Wrench, 12 Pt.	7/16"	1238	Combination Wrench, 12 Pt.	1-3/16"
1128	Combination Wrench, 12 Pt.	7/8"	1216	Combination Wrench, 12 Pt.	1/2"	1240	Combination Wrench, 12 Pt.	1-1/4"

Metric Combination Wrenches

D979 – 24 Pieces, Satin Wrenches

D980 – 24 Pieces, Full Polish Wrenches

See Page 367 for photograph.

Part No.	Description	Size	Part No.	Description	Size	Part No.	Description	Size
D979			11-22mm	Metric Combination Wrench, 12 Pt.	22mm	12-14mm	Metric Combination Wrench, 12 Pt.	14mm
11-06mm	Metric Combination Wrench, 12 Pt.	6mm	11-23mm	Metric Combination Wrench, 12 Pt.	23mm	12-15mm	Metric Combination Wrench, 12 Pt.	15mm
11-07mm	Metric Combination Wrench, 12 Pt.	7mm	11-24mm	Metric Combination Wrench, 12 Pt.	24mm	12-16mm	Metric Combination Wrench, 12 Pt.	16mm
11-08mm	Metric Combination Wrench, 12 Pt.	8mm	11-25mm	Metric Combination Wrench, 12 Pt.	25mm	12-17mm	Metric Combination Wrench, 12 Pt.	17mm
11-09mm	Metric Combination Wrench, 12 Pt.	9mm	11-26mm	Metric Combination Wrench, 12 Pt.	26mm	12-18mm	Metric Combination Wrench, 12 Pt.	18mm
11-10mm	Metric Combination Wrench, 12 Pt.	10mm	11-27mm	Metric Combination Wrench, 12 Pt.	27mm	12-19mm	Metric Combination Wrench, 12 Pt.	19mm
11-11mm	Metric Combination Wrench, 12 Pt.	11mm	11-30mm	Metric Combination Wrench, 12 Pt.	30mm	12-20mm	Metric Combination Wrench, 12 Pt.	20mm
11-12mm	Metric Combination Wrench, 12 Pt.	12mm	11-32mm	Metric Combination Wrench, 12 Pt.	32mm	12-21mm	Metric Combination Wrench, 12 Pt.	21mm
11-13mm	Metric Combination Wrench, 12 Pt.	13mm	D980			12-22mm	Metric Combination Wrench, 12 Pt.	22mm
11-14mm	Metric Combination Wrench, 12 Pt.	14mm	12-06mm	Metric Combination Wrench, 12 Pt.	6mm	12-23mm	Metric Combination Wrench, 12 Pt.	23mm
11-15mm	Metric Combination Wrench, 12 Pt.	15mm	12-07mm	Metric Combination Wrench, 12 Pt.	7mm	12-24mm	Metric Combination Wrench, 12 Pt.	24mm
11-16mm	Metric Combination Wrench, 12 Pt.	16mm	12-08mm	Metric Combination Wrench, 12 Pt.	8mm	12-25mm	Metric Combination Wrench, 12 Pt.	25mm
11-17mm	Metric Combination Wrench, 12 Pt.	17mm	12-09mm	Metric Combination Wrench, 12 Pt.	9mm	12-26mm	Metric Combination Wrench, 12 Pt.	26mm
11-18mm	Metric Combination Wrench, 12 Pt.	18mm	12-10mm	Metric Combination Wrench, 12 Pt.	10mm	12-27mm	Metric Combination Wrench, 12 Pt.	27mm
11-19mm	Metric Combination Wrench, 12 Pt.	19mm	12-11mm	Metric Combination Wrench, 12 Pt.	11mm	12-30mm	Metric Combination Wrench, 12 Pt.	30mm
11-20mm	Metric Combination Wrench, 12 Pt.	20mm	12-12mm	Metric Combination Wrench, 12 Pt.	12mm	12-32mm	Metric Combination Wrench, 12 Pt.	32mm
11-21mm	Metric Combination Wrench, 12 Pt.	21mm	12-13mm	Metric Combination Wrench, 12 Pt.	13mm			

Fractional Double Box End Wrenches

D942 – 15 Pieces, 12 Point

See Page 367 for photograph.

Part No.	Description	Size	Part No.	Description	Size	Part No.	Description	Size
51012	Box End Wrench, 12 Pt.	5/16" x 3/8"	52022	Box End Wrench, 12 Pt.	5/8" x 11/16"	52628	Open End Wrench	13/16" x 7/8"
51214	Box End Wrench, 12 Pt.	3/8" x 7/16"	52024	Box End Wrench, 12 Pt.	5/8" x 3/4"	52830	Open End Wrench	7/8" x 15/16"
51416	Box End Wrench, 12 Pt.	7/8" x 1/2"	52224	Box End Wrench, 12 Pt.	11/16" x 3/4"	53032	Open End Wrench	15/16" x 1"
51618	Box End Wrench, 12 Pt.	1/2" x 9/16"	52426	Box End Wrench, 12 Pt.	3/4" x 13/16"	53436	Open End Wrench	1-1/16" x 1-1/8"
51820	Box End Wrench, 12 Pt.	9/16" x 5/8"	52428	Box End Wrench, 12 Pt.	3/4" x 7/8"	53440	Open End Wrench	1-1/16" x 1-1/4"

Fractional Open End Wrenches

D987 – 18 Pieces

See Page 367 for photograph.

Part No.	Description	Size	Part No.	Description	Size	Part No.	Description	Size
1308	Open End Wrench	3/16" x 1/4"	1320	Open End Wrench	9/16" x 5/8"	1329	Open End Wrench	13/16" x 7/8"
1310	Open End Wrench	1/4" x 5/16"	1322	Open End Wrench	5/8" x 11/16"	1330	Open End Wrench	7/8" x 15/16"
1312	Open End Wrench	5/16" x 3/8"	1324	Open End Wrench	5/8" x 3/4"	1331	Open End Wrench	7/8" x 1-1/16"
1314	Open End Wrench	3/8" x 7/16"	1325	Open End Wrench	11/16" x 3/4"	1332	Open End Wrench	15/16" x 1"
1316	Open End Wrench	7/8" x 1/2"	1326	Open End Wrench	3/4" x 7/8"	1336	Open End Wrench	1-1/16" x 1-1/8"
1318	Open End Wrench	1/2" x 9/16"	1328	Open End Wrench	3/4" x 13/16"	1340	Open End Wrench	1-1/8" x 1-1/4"





Fractional Tubing Wrenches

D981 – 44 Pieces

See Page 368 for photograph.

Part No.	Description	Size	Part No.	Description	Size	Part No.	Description	Size
1040	Combination Open End Flare Nut Wrench	3/8"	1080	1/2" Drive Crowfoot Wrench - Flare Nut, 12 Pt.	1-1/8"	1614	Flare Nut Wrench	3/8" x 7/16"
1042	Combination Open End Flare Nut Wrench	7/16"	1081	1/2" Drive Crowfoot Wrench - Flare Nut, 12 Pt.	1-3/16"	1618	Flare Nut Wrench	1/2" x 9/16"
1044	Combination Open End Flare Nut Wrench	1/2"	1082	1/2" Drive Crowfoot Wrench - Flare Nut, 12 Pt.	1-1/4"	1622	Flare Nut Wrench	5/8" x 11/16"
1046	Combination Open End Flare Nut Wrench	9/16"	1083	1/2" Drive Crowfoot Wrench - Flare Nut, 12 Pt.	1-5/16"	1642	Ratcheting Flare Nut Wrench	3/8"
1048	Combination Open End Flare Nut Wrench	5/8"	1084	1/2" Drive Crowfoot Wrench - Flare Nut, 12 Pt.	1-3/8"	1644	Ratcheting Flare Nut Wrench	7/16"
1050	Combination Open End Flare Nut Wrench	11/16"	1085	1/2" Drive Crowfoot Wrench - Flare Nut, 12 Pt.	1-7/16"	1646	Ratcheting Flare Nut Wrench	1/2"
1052	Combination Open End Flare Nut Wrench	3/4"	1086	1/2" Drive Crowfoot Wrench - Flare Nut, 12 Pt.	1-1/2"	1648	Ratcheting Flare Nut Wrench	9/16"
1060	3/8" Drive Crowfoot Wrench - Flare Nut, 12 Pt.	5/8"	1087	1/2" Drive Crowfoot Wrench - Flare Nut, 12 Pt.	1-9/16"	1650	Ratcheting Flare Nut Wrench	5/8"
1062	3/8" Drive Crowfoot Wrench - Flare Nut, 12 Pt.	11/16"	1088	1/2" Drive Crowfoot Wrench - Flare Nut, 12 Pt.	1-5/8"	1652	Ratcheting Flare Nut Wrench	11/16"
1064	3/8" Drive Crowfoot Wrench - Flare Nut, 12 Pt.	3/4"	1089	1/2" Drive Crowfoot Wrench - Flare Nut, 12 Pt.	1-11/16"	1654	Ratcheting Flare Nut Wrench	3/4"
1066	3/8" Drive Crowfoot Wrench - Flare Nut, 12 Pt.	13/16"	1090	1/2" Drive Crowfoot Wrench - Flare Nut, 12 Pt.	1-3/4"	1656	Ratcheting Flare Nut Wrench	13/16"
1068	3/8" Drive Crowfoot Wrench - Flare Nut, 12 Pt.	7/8"	1091	1/2" Drive Crowfoot Wrench - Flare Nut, 12 Pt.	1-13/16"	1658	Ratcheting Flare Nut Wrench	7/8"
1070	3/8" Drive Crowfoot Wrench - Flare Nut, 12 Pt.	15/16"	1092	1/2" Drive Crowfoot Wrench - Flare Nut, 12 Pt.	1-7/8"	1660	Ratcheting Flare Nut Wrench	15/16"
1072	3/8" Drive Crowfoot Wrench - Flare Nut, 12 Pt.	1"	1093	1/2" Drive Crowfoot Wrench - Flare Nut, 12 Pt.	1-15/16"	1662	Ratcheting Flare Nut Wrench	1"
1074	3/8" Drive Crowfoot Wrench - Flare Nut, 12 Pt.	1-1/16"	1094	1/2" Drive Crowfoot Wrench - Flare Nut, 12 Pt.	2"			

Metric Wrenches

D956 – 29 Pieces, Ratcheting Box Wrenches, Flare Nut Wrenches & Crowfoot Wrenches

See Page 368 for photograph.

Part No.	Description	Size	Part No.	Description	Size	Part No.	Description	Size
10-10mm	3/8" Drive Metric Crowfoot Wrench	10mm	16-11mm	Metric Flare Nut Wrench, 6 Pt.	9mm x 11mm	9422	Metric Ratcheting Box Wrench, 12 Pt.	16mm x 18mm
10-11mm	3/8" Drive Metric Crowfoot Wrench	11mm	16-12mm	Metric Flare Nut Wrench, 6 Pt.	10mm x 12mm	9423	Metric Ratcheting Box Wrench, 12 Pt.	19mm x 21mm
10-12mm	3/8" Drive Metric Crowfoot Wrench	12mm	16-14mm	Metric Flare Nut Wrench, 6 Pt.	13mm x 14mm	9431	Metric Offset Ratcheting Box Wrench, 6 Pt.	7mm x 8mm
10-13mm	3/8" Drive Metric Crowfoot Wrench	13mm	16-17mm	Metric Flare Nut Wrench, 6 Pt.	15mm x 17mm	9432	Metric Offset Ratcheting Box Wrench, 6 Pt.	9mm x 10mm
10-14mm	3/8" Drive Metric Crowfoot Wrench	14mm	16-21mm	Metric Flare Nut Wrench, 6 Pt.	19mm x 21mm	9434	Metric Offset Ratcheting Box Wrench, 6 Pt.	11mm x 12mm
10-15mm	3/8" Drive Metric Crowfoot Wrench	15mm	9416	Metric Ratcheting Box Wrench, 6 Pt.	7mm x 8mm	9435	Metric Offset Ratcheting Box Wrench, 6 Pt.	13mm x 14mm
10-16mm	3/8" Drive Metric Crowfoot Wrench	16mm	9417	Metric Ratcheting Box Wrench, 6 Pt.	9mm x 10mm	9436	Metric Offset Ratcheting Box Wrench, 12 Pt.	15mm x 17mm
10-17mm	3/8" Drive Metric Crowfoot Wrench	17mm	9418	Metric Ratcheting Box Wrench, 6 Pt.	11mm x 12mm	9437	Metric Offset Ratcheting Box Wrench, 12 Pt.	16mm x 18mm
10-18mm	3/8" Drive Metric Crowfoot Wrench	18mm	9419	Metric Ratcheting Box Wrench, 6 Pt.	13mm x 14mm	9438	Metric Offset Ratcheting Box Wrench, 12 Pt.	19mm x 21mm
10-19mm	3/8" Drive Metric Crowfoot Wrench	19mm	9421	Metric Ratcheting Box Wrench, 12 Pt.	15mm x 17mm			

Fractional Service Wrenches

D943 – 22 Pieces

See Page 368 for photograph.

Part No.	Description	Size	Part No.	Description	Size	Part No.	Description	Size
1424	Service Wrench, 30° Angle	3/4"	1440	Service Wrench, 30° Angle	1-1/4"	1458	Service Wrench, 30° Angle	1-13/16"
1426	Service Wrench, 30° Angle	13/16"	1442	Service Wrench, 30° Angle	1-5/16"	1460	Service Wrench, 30° Angle	1-7/8"
1428	Service Wrench, 30° Angle	7/8"	1444	Service Wrench, 30° Angle	1-3/8"	1462	Service Wrench, 30° Angle	1-15/16"
1430	Service Wrench, 30° Angle	15/16"	1446	Service Wrench, 30° Angle	1-7/16"	1464	Service Wrench, 30° Angle	2"
1432	Service Wrench, 30° Angle	1"	1448	Service Wrench, 30° Angle	1-1/2"	1468	Service Wrench, 30° Angle	2-1/8"
1434	Service Wrench, 30° Angle	1-1/16"	1450	Service Wrench, 30° Angle	1-9/16"	1472	Service Wrench, 30° Angle	2-1/4"
1436	Service Wrench, 30° Angle	1-1/8"	1452	Service Wrench, 30° Angle	1-5/8"			
1438	Service Wrench, 30° Angle	1-3/16"	1456	Service Wrench, 30° Angle	1-3/4"			





Salesmen's Sample Case

D940 – 33 Pieces

See Page 368 for photograph.

Part No.	Description	Size	Part No.	Description	Size	Part No.	Description	Size
1018	3/8" Drive Open-End Crowfoot Wrench	9/16"	3475	3/8" Drive Universal		9556	Starter Punch	3/16" x 5"
1118	Combination Wrench, 12 Pt.	9/16"	3490	3/8" Drive Ratchet, Double Pawl	7-1/32"	9594	Pin Punch	3/16" x 5-1/4"
1218	Combination Wrench, 12 Pt.	9/16"	3518	3/8" Drive Deep Socket, 6 Pt.	9/16"	9602	Cold Chisel	3/8" x 5-1/2"
2426	1/4" Drive Ratchet	4-3/4"	3618	3/8" Drive Deep Socket, 12 Pt.	9/16"	9604	Cold Chisel	5/8" x 6-1/2"
2612	1/4" Drive Deep Socket, 12 Pt.	3/8"	4114	1/2" Drive Standard Socket, 12 Pt.	7/16"	9606	Cold Chisel	7/8" x 7-1/2"
3018	3/8" Drive Deep Socket, 6 Pt.	9/16"	4480	1/2" Drive Open Head Ratchet, Pear Shape	10-1/2"	9AB08	Adjustable Wrench, Black Industrial Finish	8"
3118	3/8" Drive Standard Socket, 12 Pt.	9/16"	4824	1/2" Drive Standard Impact Socket	3-8"	9AC08	Adjustable Wrench,	8"
3405	3/8" Drive Extension	5"	4900	1/2" Drive Impact Adaptor		9C426	Tongue and Groove Pliers	6-1/2"
3411	3/8" Drive Wobble Extension	6"	4924	1/2" Drive Deep Impact Socket	3/4"	9V4LN	Long Nose Locking Pliers w/Wire Cutter	4"
3426	3/8" Drive Ratchet, Knurled Grip	7"	9104	Phillips Screwdriver #1	3"			
3430	3/8" Drive Ratchet, Compact-Palm Size	4-3/4"	9163	Cushion Grip Cabinet Tip Screwdriver	8"			
3438	3/8" Drive Flex Handle	9-11/16"	9536	Center Punch	1/4" x 3-1/2"			

Adjustable Wrenches

D975 – 30 Pieces, 6 each size, 12" Wide Display

See Page 369 for photograph.

Part No.	Description	Size
9AC04	Adjustable Wrench, Cobalt Finish	4"
9AC06	Adjustable Wrench, Cobalt Finish	6"
9AC08	Adjustable Wrench, Cobalt Finish	8"
9AC10	Adjustable Wrench, Cobalt Finish	10"
9AC12	Adjustable Wrench, Cobalt Finish	12"

Adjustable Wrenches

D976 – 30 Pieces, 6 each size, 12" Wide Display

See Page 369 for photograph.

Part No.	Description	Size
9AB04	Adjustable Wrench, Black Industrial Finish	4"
9AB06	Adjustable Wrench, Black Industrial Finish	6"
9AB08	Adjustable Wrench, Black Industrial Finish	8"
9AB10	Adjustable Wrench, Black Industrial Finish	10"
9AB12	Adjustable Wrench, Black Industrial Finish	12"

Ridgid Pipe Wrenches

D972 – 6 Pieces

See Page 369 for photograph.

Part No.	Description	Size
9R31005	Ridgid Pipe Wrench, Heavy-Duty	8"
9R31010	Ridgid Pipe Wrench, Heavy-Duty	10"
9R31015	Ridgid Pipe Wrench, Heavy-Duty	12"
9R31020	Ridgid Pipe Wrench, Heavy-Duty	14"
9R31025	Ridgid Pipe Wrench, Heavy-Duty	18"
9R31030	Ridgid Pipe Wrench, Heavy-Duty	24"

Adjustable Wrenches

D961 – 18 Pieces

See Page 369 for photograph.

Part No.	Description	Size	Part No.	Description	Size	Part No.	Description	Size
9414	Adjustable Construction Wrench	16"	9AB15	Adjustable Wrench, Black Industrial Finish	15"	9AC15	Adjustable Wrench, Cobalt Finish	15"
9AB04	Adjustable Wrench, Black Industrial Finish	4"	9AC04	Adjustable Wrench, Cobalt Finish	4"	9AG04	Adjustable Wrench, Cobalt Finish, Cushion Grip	4"
9AB06	Adjustable Wrench, Black Industrial Finish	6"	9AC06	Adjustable Wrench, Cobalt Finish	6"	9AG06	Adjustable Wrench, Cobalt Finish, Cushion Grip	6"
9AB08	Adjustable Wrench, Black Industrial Finish	8"	9AC08	Adjustable Wrench, Cobalt Finish	8"	9AG08	Adjustable Wrench, Cobalt Finish, Cushion Grip	8"
9AB10	Adjustable Wrench, Black Industrial Finish	10"	9AC10	Adjustable Wrench, Cobalt Finish	10"	9AG10	Adjustable Wrench, Cobalt Finish, Cushion Grip	10"
9AB12	Adjustable Wrench, Black Industrial Finish	12"	9AC12	Adjustable Wrench, Cobalt Finish	12"	9AG12	Adjustable Wrench, Cobalt Finish, Cushion Grip	12"





Fractional Sockets, Handles & Attachments

D982 – 78 Pieces, 1/4" Drive 6 & 12 Pt.

Sockets, Handles & Attachments

See Page 370 for photograph.

Part No.	Description	Size	Part No.	Description	Size	Part No.	Description	Size
2005	1/4" Drive Standard Socket, 6 Pt.	5/32"	2208	1/4" Drive Hex Bit Socket	5/32"	2495	Flex Head Ratchet (contour grip)	5-1/2"
2006	1/4" Drive Standard Socket, 6 Pt.	3/16"	2210	1/4" Drive Hex Bit Socket	3/16"	2506	1/4" Drive Deep Socket, 6 Pt.	3/16"
2007	1/4" Drive Standard Socket, 6 Pt.	7/32"	2212	1/4" Drive Hex Bit Socket	7/32"	2507	1/4" Drive Deep Socket, 6 Pt.	7/32"
2008	1/4" Drive Standard Socket, 6 Pt.	1/4"	2214	1/4" Drive Hex Bit Socket	1/4"	2508	1/4" Drive Deep Socket, 6 Pt.	1/4"
2009	1/4" Drive Standard Socket, 6 Pt.	9/32"	2218	1/4" Drive Hex Bit Socket	5/16"	2509	1/4" Drive Deep Socket, 6 Pt.	9/32"
2010	1/4" Drive Standard Socket, 6 Pt.	5/16"	2260	1/4" Drive Standard Screwdriver Socket with Bit	3/16"	2510	1/4" Drive Deep Socket, 6 Pt.	5/16"
2011	1/4" Drive Standard Socket, 6 Pt.	11/32"	2261	1/4" Drive Standard Screwdriver Socket with Bit	1/4"	2511	1/4" Drive Deep Socket, 6 Pt.	11/32"
2012	1/4" Drive Standard Socket, 6 Pt.	3/8"	2263	1/4" Drive Standard Screwdriver Socket with Bit	23/64"	2512	1/4" Drive Deep Socket, 6 Pt.	3/8"
2014	1/4" Drive Standard Socket, 6 Pt.	7/16"	2265	1/4" Drive Phillips Screwdriver Socket with Bit	#1	2514	1/4" Drive Deep Socket, 6 Pt.	7/16"
2016	1/4" Drive Standard Socket, 6 Pt.	1/2"	2266	1/4" Drive Phillips Screwdriver Socket with Bit	#2	2516	1/4" Drive Deep Socket, 6 Pt.	1/2"
2106	1/4" Drive Standard Socket, 12 Pt.	3/16"	2267	1/4" Drive Long Phillips Screwdriver Socket with Bit	#1	2606	1/4" Drive Deep Socket, 12 Pt.	3/16"
2107	1/4" Drive Standard Socket, 12 Pt.	7/32"	2308	1/4" Drive Special 8 Pt. Standard Socket	1/4"	2607	1/4" Drive Deep Socket, 12 Pt.	7/32"
2108	1/4" Drive Standard Socket, 12 Pt.	1/4"	2310	1/4" Drive Special 8 Pt. Standard Socket	5/16"	2608	1/4" Drive Deep Socket, 12 Pt.	1/4"
2109	1/4" Drive Standard Socket, 12 Pt.	9/32"	2312	1/4" Drive Special 8 Pt. Standard Socket	3/8"	2609	1/4" Drive Deep Socket, 12 Pt.	9/32"
2110	1/4" Drive Standard Socket, 12 Pt.	5/16"	2402	1/4" Drive Extension	2"	2610	1/4" Drive Deep Socket, 12 Pt.	5/16"
2111	1/4" Drive Standard Socket, 12 Pt.	11/32"	2404	1/4" Drive Extension	4"	2611	1/4" Drive Deep Socket, 12 Pt.	11/32"
2112	1/4" Drive Standard Socket, 12 Pt.	3/8"	2406	1/4" Drive Extension	6"	2612	1/4" Drive Deep Socket, 12 Pt.	3/8"
2114	1/4" Drive Standard Socket, 12 Pt.	7/16"	2410	1/4" Drive Extension	10"	2614	1/4" Drive Deep Socket, 12 Pt.	7/16"
2116	1/4" Drive Standard Socket, 12 Pt.	1/2"	2413	1/4" Drive Locking Adaptor		2616	1/4" Drive Deep Socket, 12 Pt.	1/2"
2118	1/4" Drive Standard Socket, 12 Pt.	9/16"	2426	1/4" Drive Ratchet	4-3/4"	2618	1/4" Drive Deep Socket, 12 Pt.	9/16"
2202	1/4" Drive Hex Bit Socket	1/16"	2435	1/4" Drive Flex Handle	5"	2708	1/4" Drive Flex Socket, 12 Pt.	1/4"
2203	1/4" Drive Hex Bit Socket	5/64"	2442	1/4" Drive Spinner w/Female End	6"	2710	1/4" Drive Flex Socket, 12 Pt.	5/16"
2204	1/4" Drive Hex Bit Socket	3/32"	2445	1/4" Drive Speeder		2712	1/4" Drive Flex Socket, 12 Pt.	3/8"
2205	1/4" Drive Hex Bit Socket	7/64"	2453	1/4" Drive Adaptor		2714	1/4" Drive Flex Socket, 12 Pt.	7/16"
2206	1/4" Drive Hex Bit Socket	1/8"	2475	1/4" Drive Universal Joint		2716	1/4" Drive Flex Socket, 12 Pt.	1/2"
2207	1/4" Drive Hex Bit Socket	9/64"	2492	1/4" Drive Heavy-duty Ratchet	5-1/4"	9203	1/2" Drive Socket Screwdriver with Long Bit	#2

Metric Sockets

D957 – 78 Pieces, 1/4" & 3/8" Drive 6 & 12 Pt. Sockets

See Page 370 for photograph.

Part No.	Description	Size	Part No.	Description	Size	Part No.	Description	Size
20-05mm	1/4" Drive Standard Metric Socket, 6 Pt.	5mm	30-14mm	3/8" Drive Standard Metric Socket, 6 Pt.	14mm	32-08mm	3/8" Drive Metric Hex Bit Socket	8mm
20-06mm	1/4" Drive Standard Metric Socket, 6 Pt.	6mm	30-15mm	3/8" Drive Standard Metric Socket, 6 Pt.	15mm	32-10mm	3/8" Drive Metric Hex Bit Socket	10mm
20-07mm	1/4" Drive Standard Metric Socket, 6 Pt.	7mm	30-16mm	3/8" Drive Standard Metric Socket, 6 Pt.	16mm	35-06mm	3/8" Drive Deep Metric Socket, 6 Pt.	6mm
20-08mm	1/4" Drive Standard Metric Socket, 6 Pt.	8mm	30-17mm	3/8" Drive Standard Metric Socket, 6 Pt.	17mm	35-07mm	3/8" Drive Deep Metric Socket, 6 Pt.	7mm
20-09mm	1/4" Drive Standard Metric Socket, 6 Pt.	9mm	30-18mm	3/8" Drive Standard Metric Socket, 6 Pt.	18mm	35-08mm	3/8" Drive Deep Metric Socket, 6 Pt.	8mm
20-10mm	1/4" Drive Standard Metric Socket, 6 Pt.	10mm	30-19mm	3/8" Drive Standard Metric Socket, 6 Pt.	19mm	35-09mm	3/8" Drive Deep Metric Socket, 6 Pt.	9mm
20-11mm	1/4" Drive Standard Metric Socket, 6 Pt.	11mm	31-08mm	3/8" Drive Standard Metric Socket, 12 Pt.	8mm	35-10mm	3/8" Drive Deep Metric Socket, 6 Pt.	10mm
20-12mm	1/4" Drive Standard Metric Socket, 6 Pt.	12mm	31-09mm	3/8" Drive Standard Metric Socket, 12 Pt.	9mm	35-11mm	3/8" Drive Deep Metric Socket, 6 Pt.	11mm
20-13mm	1/4" Drive Standard Metric Socket, 6 Pt.	13mm	31-10mm	3/8" Drive Standard Metric Socket, 12 Pt.	10mm	35-12mm	3/8" Drive Deep Metric Socket, 6 Pt.	12mm
25-04mm	1/4" Drive Deep Metric Socket, 6 Pt.	4mm	31-11mm	3/8" Drive Standard Metric Socket, 12 Pt.	11mm	35-13mm	3/8" Drive Deep Metric Socket, 6 Pt.	13mm
25-05mm	1/4" Drive Deep Metric Socket, 6 Pt.	5mm	31-12mm	3/8" Drive Standard Metric Socket, 12 Pt.	12mm	35-14mm	3/8" Drive Deep Metric Socket, 6 Pt.	14mm
25-06mm	1/4" Drive Deep Metric Socket, 6 Pt.	6mm	31-13mm	3/8" Drive Standard Metric Socket, 12 Pt.	13mm	35-15mm	3/8" Drive Deep Metric Socket, 6 Pt.	15mm
25-07mm	1/4" Drive Deep Metric Socket, 6 Pt.	7mm	31-14mm	3/8" Drive Standard Metric Socket, 12 Pt.	14mm	35-16mm	3/8" Drive Deep Metric Socket, 6 Pt.	16mm
25-08mm	1/4" Drive Deep Metric Socket, 6 Pt.	8mm	31-15mm	3/8" Drive Standard Metric Socket, 12 Pt.	15mm	35-17mm	3/8" Drive Deep Metric Socket, 6 Pt.	17mm
25-09mm	1/4" Drive Deep Metric Socket, 6 Pt.	9mm	31-16mm	3/8" Drive Standard Metric Socket, 12 Pt.	16mm	35-18mm	3/8" Drive Deep Metric Socket, 6 Pt.	18mm
25-10mm	1/4" Drive Deep Metric Socket, 6 Pt.	10mm	31-17mm	3/8" Drive Standard Metric Socket, 12 Pt.	17mm	35-19mm	3/8" Drive Deep Metric Socket, 6 Pt.	19mm
25-11mm	1/4" Drive Deep Metric Socket, 6 Pt.	11mm	31-18mm	3/8" Drive Standard Metric Socket, 12 Pt.	18mm	36-09mm	3/8" Drive Deep Metric Socket, 12 Pt.	9mm
25-12mm	1/4" Drive Deep Metric Socket, 6 Pt.	12mm	31-19mm	3/8" Drive Standard Metric Socket, 12 Pt.	19mm	36-10mm	3/8" Drive Deep Metric Socket, 12 Pt.	10mm
25-13mm	1/4" Drive Deep Metric Socket, 6 Pt.	13mm	31-20mm	3/8" Drive Standard Metric Socket, 12 Pt.	20mm	36-11mm	3/8" Drive Deep Metric Socket, 12 Pt.	11mm
30-06mm	3/8" Drive Standard Metric Socket, 6 Pt.	6mm	31-21mm	3/8" Drive Standard Metric Socket, 12 Pt.	21mm	36-12mm	3/8" Drive Deep Metric Socket, 12 Pt.	12mm
30-07mm	3/8" Drive Standard Metric Socket, 6 Pt.	7mm	31-22mm	3/8" Drive Standard Metric Socket, 12 Pt.	22mm	36-13mm	3/8" Drive Deep Metric Socket, 12 Pt.	13mm
30-08mm	3/8" Drive Standard Metric Socket, 6 Pt.	8mm	32-02mm	3/8" Drive Metric Hex Bit Socket	2mm	36-14mm	3/8" Drive Deep Metric Socket, 12 Pt.	14mm
30-09mm	3/8" Drive Standard Metric Socket, 6 Pt.	9mm	32-02.5mm	3/8" Drive Metric Hex Bit Socket	2.5mm	36-15mm	3/8" Drive Deep Metric Socket, 12 Pt.	15mm
30-10mm	3/8" Drive Standard Metric Socket, 6 Pt.	10mm	32-03mm	3/8" Drive Metric Hex Bit Socket	3mm	36-17mm	3/8" Drive Deep Metric Socket, 12 Pt.	17mm
30-11mm	3/8" Drive Standard Metric Socket, 6 Pt.	11mm	32-04mm	3/8" Drive Metric Hex Bit Socket	4mm	36-19mm	3/8" Drive Deep Metric Socket, 12 Pt.	19mm
30-12mm	3/8" Drive Standard Metric Socket, 6 Pt.	12mm	32-05mm	3/8" Drive Metric Hex Bit Socket	5mm			
30-13mm	3/8" Drive Standard Metric Socket, 6 Pt.	13mm	32-06mm	3/8" Drive Metric Hex Bit Socket	6mm			

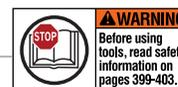



Fractional Handles & Attachments

D983 – 34 Pieces, 3/8" Drive Handles & Attachments

See Page 370 for photograph.

Part No.	Description	Size	Part No.	Description	Size	Part No.	Description	Size
1012	3/8" Drive Crowfoot Wrench	3/8"	3403	3/8" Drive Extension	3"	3430	3/8" Drive Ratchet, Compact	4-3/4"
1014	3/8" Drive Crowfoot Wrench	7/16"	3405	3/8" Drive Extension	5"	3435	3/8" Drive Flex Handle	8-15/32"
1016	3/8" Drive Crowfoot Wrench	1/2"	3409	3/8" Drive Wobble Extension	1-1/2"	3438	3/8" Drive Flex Handle	9-11/16"
1018	3/8" Drive Crowfoot Wrench	9/16"	3410	3/8" Drive Wobble Extension	3"	3439	3/8" Drive Flex Handle	10-3/4"
1020	3/8" Drive Crowfoot Wrench	5/8"	3411	3/8" Drive Wobble Extension	6"	3440	3/8" Drive Ratchet, Compact Flex Head	10"
1022	3/8" Drive Crowfoot Wrench	11/16"	3412	3/8" Drive Extension	12"	3443	3/8" Drive Sliding T	7"
1024	3/8" Drive Crowfoot Wrench	3/4"	3413	3/8" Drive Locking Adaptor		3445	3/8" Drive Speeder	14-1/2"
1026	3/8" Drive Crowfoot Wrench	13/16"	3425	3/8" Drive Long Ratchet	10"	3480	3/8" Drive Ratchet, Pear-Shaped Open Head	7-7/8"
1028	3/8" Drive Crowfoot Wrench	7/8"	3426	3/8" Drive Ratchet, Knurled Grip	7"	3482	Open-Head Combination 1/4" & 3/8" Ratchet	
1032	3/8" Drive Crowfoot Wrench	1"	3427	3/8" Drive Ratchet, Knurled Grip Flex Handle	9-11/16"	3490	3/8" Drive Ratchet, Double Pawl, Contour Handle	7-1/32"
3400	3/8" Drive Ratchet, Nitrile Grip	1-1/2"	3428	3/8" Drive Ratchet, Nitrile Grip	10-3/4"			
3402	3/8" Drive Extension	1-1/2"	3429	3/8" Drive Ratchet, Bent Flex Nitrile Grip	10-3/4"			

Fractional Sockets

D984 – 91 Pieces, 3/8" Drive 6 & 12 Pt.

Sockets

See Page 370 for photograph.

Part No.	Description	Size	Part No.	Description	Size	Part No.	Description	Size
3008	3/8" Drive Standard Socket, 6 Pt.	1/4"	3210	3/8" Drive Hex Bit Socket	5/16"	3518	3/8" Drive Deep Socket, 6 Pt.	9/16"
3010	3/8" Drive Standard Socket, 6 Pt.	5/16"	3212	3/8" Drive Hex Bit Socket	3/8"	3520	3/8" Drive Deep Socket, 6 Pt.	5/8"
3012	3/8" Drive Standard Socket, 6 Pt.	3/8"	3246	3/8" Drive Long Hex Bit Socket	3/16"	3522	3/8" Drive Deep Socket, 6 Pt.	11/16"
3014	3/8" Drive Standard Socket, 6 Pt.	7/16"	3248	3/8" Drive Long Hex Bit Socket	1/4"	3524	3/8" Drive Deep Socket, 6 Pt.	3/4"
3016	3/8" Drive Standard Socket, 6 Pt.	1/2"	3252	3/8" Drive Long Hex Bit Socket	3/8"	3526	3/8" Drive Deep Socket, 6 Pt.	13/16"
3018	3/8" Drive Standard Socket, 6 Pt.	9/16"	3260	3/8" Drive Standard Screwdriver Socket with Bit	1/4"	3528	3/8" Drive Deep Socket, 6 Pt.	7/8"
3020	3/8" Drive Standard Socket, 6 Pt.	5/8"	3261	3/8" Drive Standard Screwdriver Socket with Bit	5/16"	3530	3/8" Drive Deep Socket, 6 Pt.	15/16"
3022	3/8" Drive Standard Socket, 6 Pt.	11/16"	3262	3/8" Drive Standard Screwdriver Socket with Bit	3/8"	3532	3/8" Drive Deep Socket, 6 Pt.	1"
3024	3/8" Drive Standard Socket, 6 Pt.	3/4"	3265	3/8" Drive Phillips Screwdriver Socket with Bit	#1	3588	3/8" Drive Spark Plug Holding Socket	18mm
3026	3/8" Drive Standard Socket, 6 Pt.	13/16"	3266	3/8" Drive Phillips Screwdriver Socket with Bit	#2	3590	3/8" Drive Spark Plug Holding Socket	5/8"
3028	3/8" Drive Standard Socket, 6 Pt.	7/8"	3267	3/8" Drive Phillips Screwdriver Socket with Bit	#3	3596	3/8" Drive Spark Plug Holding Socket	13/16"
3030	3/8" Drive Standard Socket, 6 Pt.	15/16"	3268	3/8" Drive Phillips Screwdriver Socket with Bit	#4	3612	3/8" Drive Deep Socket, 12 Pt.	3/8"
3032	3/8" Drive Standard Socket, 6 Pt.	1"	3308	3/8" Drive Special 8 Pt. Standard Socket	1/4"	3614	3/8" Drive Deep Socket, 12 Pt.	7/16"
3108	3/8" Drive Standard Socket, 12 Pt.	1/4"	3310	3/8" Drive Special 8 Pt. Standard Socket	5/16"	3616	3/8" Drive Deep Socket, 12 Pt.	1/2"
3110	3/8" Drive Standard Socket, 12 Pt.	5/16"	3312	3/8" Drive Special 8 Pt. Standard Socket	3/8"	3618	3/8" Drive Deep Socket, 12 Pt.	9/16"
3112	3/8" Drive Standard Socket, 12 Pt.	3/8"	3314	3/8" Drive Special 8 Pt. Standard Socket	7/16"	3620	3/8" Drive Deep Socket, 12 Pt.	5/8"
3114	3/8" Drive Standard Socket, 12 Pt.	7/16"	3316	3/8" Drive Special 8 Pt. Standard Socket	1/2"	3622	3/8" Drive Deep Socket, 12 Pt.	11/16"
3116	3/8" Drive Standard Socket, 12 Pt.	1/2"	3318	3/8" Drive Special 8 Pt. Standard Socket	9/16"	3624	3/8" Drive Deep Socket, 12 Pt.	3/4"
3118	3/8" Drive Standard Socket, 12 Pt.	9/16"	3320	3/8" Drive Special 8 Pt. Standard Socket	5/8"	3626	3/8" Drive Deep Socket, 12 Pt.	13/16"
3120	3/8" Drive Standard Socket, 12 Pt.	5/8"	3322	3/8" Drive Special 8 Pt. Standard Socket	11/16"	3628	3/8" Drive Deep Socket, 12 Pt.	7/8"
3122	3/8" Drive Standard Socket, 12 Pt.	11/16"	3324	3/8" Drive Special 8 Pt. Standard Socket	3/4"	3630	3/8" Drive Deep Socket, 12 Pt.	5/16"
3124	3/8" Drive Standard Socket, 12 Pt.	3/4"	3326	3/8" Drive Special 8 Pt. Standard Socket	13/16"	3632	3/8" Drive Deep Socket, 12 Pt.	1"
3126	3/8" Drive Standard Socket, 12 Pt.	13/16"	3328	3/8" Drive Special 8 Pt. Standard Socket	7/8"	3712	3/8" Drive Flex Socket, 12 Pt.	3/8"
3128	3/8" Drive Standard Socket, 12 Pt.	7/8"	3452	3/8" Drive Adaptor		3714	3/8" Drive Flex Socket, 12 Pt.	7/16"
3130	3/8" Drive Standard Socket, 12 Pt.	15/16"	3454	3/8" Drive Adaptor		3716	3/8" Drive Flex Socket, 12 Pt.	1/2"
3132	3/8" Drive Standard Socket, 12 Pt.	1"	3475	3/8" Drive Universal		3718	3/8" Drive Flex Socket, 12 Pt.	9/16"
3204	3/8" Drive Hex Bit Socket	1/8"	3508	3/8" Drive Deep Socket, 6 Pt.	1/4"	3720	3/8" Drive Flex Socket, 12 Pt.	5/8"
3205	3/8" Drive Hex Bit Socket	5/32"	3510	3/8" Drive Deep Socket, 6 Pt.	5/16"	3722	3/8" Drive Flex Socket, 12 Pt.	11/16"
3206	3/8" Drive Hex Bit Socket	3/16"	3512	3/8" Drive Deep Socket, 6 Pt.	3/8"	3724	3/8" Drive Flex Socket, 12 Pt.	3/4"
3207	3/8" Drive Hex Bit Socket	7/32"	3514	3/8" Drive Deep Socket, 6 Pt.	7/16"			
3208	3/8" Drive Hex Bit Socket	1/4"	3516	3/8" Drive Deep Socket, 6 Pt.	1/2"			



WARNING
Wear safety goggles user and bystander.



WARNING
Before using tools, read safety information on pages 399-403.



WARNING
Comfort or plastic grips do not protect against electric shock.



Fractional Handles & Attachments

D946 – 17 Pieces, 1/2" Drive Handles & Attachments

See Page 371 for photograph.

Part No.	Description	Size	Part No.	Description	Size	Part No.	Description	Size
4400	1/2" Drive Ratchet, Nitrile Comfort Grip Handle	10-1/2"	4425	1/2" Drive Ratchet, Long Knurled Grip Handle	15"	4443	1/2" Drive Sliding T	10-11/16"
4402	1/2" Drive Extension	1-1/2"	4426	1/2" Drive Ratchet, Knurled Grip Handle	10-1/4"	4445	1/2" Drive Speeder	16-3/4"
4405	1/2" Drive Extension	5"	4435	1/2" Drive Flex Handle	18"	4480	1/2" Drive Ratchet, Open Head, Pear Shape	10-1/2"
4409	1/2" Drive Wobble Extension	1-1/2"	4437	1/2" Drive Flex Handle	10-5/8"	4490	1/2" Drive Ratchet, Double Pawl, Contour Grip	11"
4410	1/2" Drive Extension	10"	4438	1/2" Drive Flex Handle	18"	4494	1/2" Drive Ratchet, Double Pawl, Contour Grip	15"
4420	1/2" Drive Extension	20"	4439	1/2" Drive Flex Handle	18"			

Fractional Standard & Deep Sockets

D947 – 61 Pieces, 1/2" Drive 6 Pt. Standard & Deep Sockets

See Page 371 for photograph.

Part No.	Description	Size	Part No.	Description	Size	Part No.	Description	Size
4012	1/2" Drive Standard Socket, 6 Pt.	3/8"	4212	1/2" Drive Hex Bits Socket	3/8"	4516	1/2" Drive Deep Socket, 6 Pt.	1/2"
4014	1/2" Drive Standard Socket, 6 Pt.	7/16"	4214	1/2" Drive Hex Bits Socket	7/16"	4518	1/2" Drive Deep Socket, 6 Pt.	9/16"
4016	1/2" Drive Standard Socket, 6 Pt.	1/2"	4216	1/2" Drive Hex Bits Socket	1/2"	4520	1/2" Drive Deep Socket, 6 Pt.	5/8"
4018	1/2" Drive Standard Socket, 6 Pt.	9/16"	4218	1/2" Drive Hex Bits Socket	9/16"	4522	1/2" Drive Deep Socket, 6 Pt.	11/16"
4020	1/2" Drive Standard Socket, 6 Pt.	5/8"	4220	1/2" Drive Hex Bits Socket	5/8"	4524	1/2" Drive Deep Socket, 6 Pt.	3/4"
4022	1/2" Drive Standard Socket, 6 Pt.	11/16"	4312	1/2" Drive Special 8 Pt. Standard Socket	3/8"	4526	1/2" Drive Deep Socket, 6 Pt.	13/16"
4024	1/2" Drive Standard Socket, 6 Pt.	3/4"	4314	1/2" Drive Special 8 Pt. Standard Socket	7/16"	4528	1/2" Drive Deep Socket, 6 Pt.	7/8"
4026	1/2" Drive Standard Socket, 6 Pt.	13/16"	4316	1/2" Drive Special 8 Pt. Standard Socket	1/2"	4530	1/2" Drive Deep Socket, 6 Pt.	15/16"
4028	1/2" Drive Standard Socket, 6 Pt.	7/8"	4318	1/2" Drive Special 8 Pt. Standard Socket	9/16"	4532	1/2" Drive Deep Socket, 6 Pt.	1"
4030	1/2" Drive Standard Socket, 6 Pt.	15/16"	4320	1/2" Drive Special 8 Pt. Standard Socket	5/8"	4534	1/2" Drive Deep Socket, 6 Pt.	1-1/16"
4032	1/2" Drive Standard Socket, 6 Pt.	1"	4322	1/2" Drive Special 8 Pt. Standard Socket	11/16"	4536	1/2" Drive Deep Socket, 6 Pt.	1-1/8"
4034	1/2" Drive Standard Socket, 6 Pt.	1-1/16"	4324	1/2" Drive Special 8 Pt. Standard Socket	3/4"	4540	1/2" Drive Deep Socket, 6 Pt.	1-1/4"
4036	1/2" Drive Standard Socket, 6 Pt.	1-1/8"	4326	1/2" Drive Special 8 Pt. Standard Socket	13/16"	4542	1/2" Drive Deep Socket, 6 Pt.	1-5/8"
4038	1/2" Drive Standard Socket, 6 Pt.	1-3/16"	4328	1/2" Drive Special 8 Pt. Standard Socket	7/8"	4544	1/2" Drive Deep Socket, 6 Pt.	1-3/8"
4040	1/2" Drive Standard Socket, 6 Pt.	1-1/4"	4330	1/2" Drive Special 8 Pt. Standard Socket	15/16"	4546	1/2" Drive Deep Socket, 6 Pt.	1-7/16"
4042	1/2" Drive Standard Socket, 6 Pt.	1-5/16"	4332	1/2" Drive Special 8 Pt. Standard Socket	1"	4548	1/2" Drive Deep Socket, 6 Pt.	1-1/2"
4044	1/2" Drive Standard Socket, 6 Pt.	1-3/8"	4334	1/2" Drive Special 8 Pt. Standard Socket	1-1/16"	4590	1/2" Drive Spark Plug Holding Socket	5/8"
4046	1/2" Drive Standard Socket, 6 Pt.	1-7/16"	4336	1/2" Drive Special 8 Pt. Standard Socket	1-1/8"	4596	1/2" Drive Spark Plug Holding Socket	13/16"
4048	1/2" Drive Standard Socket, 6 Pt.	1-1/2"	4340	1/2" Drive Special 8 Pt. Standard Socket	1-1/4"	4598	1/2" Drive Spark Plug Holding Socket	7/8"
4208	1/2" Drive Hex Bits Socket	1/4"	4512	1/2" Drive Deep Socket, 6 Pt.	3/8"			
4210	1/2" Drive Hex Bits Socket	5/16"	4514	1/2" Drive Deep Socket, 6 Pt.	7/16"			

Fractional Standard & Deep Sockets

D948 – 40 Pieces, 1/2" Drive 12 Pt. Standard & Deep Sockets

See Page 371 for photograph.

Part No.	Description	Size	Part No.	Description	Size	Part No.	Description	Size
4112	1/2" Drive Standard Socket, 12 Pt.	3/8"	4140	1/2" Drive Standard Socket, 12 Pt.	1-1/4"	4626	1/2" Drive Deep Socket, 12 Pt.	13/16"
4114	1/2" Drive Standard Socket, 12 Pt.	7/16"	4142	1/2" Drive Standard Socket, 12 Pt.	1-5/16"	4628	1/2" Drive Deep Socket, 12 Pt.	7/8"
4116	1/2" Drive Standard Socket, 12 Pt.	1/2"	4144	1/2" Drive Standard Socket, 12 Pt.	1-3/8"	4630	1/2" Drive Deep Socket, 12 Pt.	15/16"
4118	1/2" Drive Standard Socket, 12 Pt.	9/16"	4146	1/2" Drive Standard Socket, 12 Pt.	1-7/16"	4632	1/2" Drive Deep Socket, 12 Pt.	1"
4120	1/2" Drive Standard Socket, 12 Pt.	5/8"	4148	1/2" Drive Standard Socket, 12 Pt.	1-1/2"	4634	1/2" Drive Deep Socket, 12 Pt.	1-1/16"
4122	1/2" Drive Standard Socket, 12 Pt.	11/16"	4453	1/2" Drive Adaptor		4636	1/2" Drive Deep Socket, 12 Pt.	1-1/8"
4124	1/2" Drive Standard Socket, 12 Pt.	3/4"	4475	1/2" Drive Universal		4638	1/2" Drive Deep Socket, 12 Pt.	1-3/16"
4126	1/2" Drive Standard Socket, 12 Pt.	13/16"	4612	1/2" Drive Deep Socket, 12 Pt.	3/8"	4640	1/2" Drive Deep Socket, 12 Pt.	1-1/4"
4128	1/2" Drive Standard Socket, 12 Pt.	7/8"	4614	1/2" Drive Deep Socket, 12 Pt.	7/16"	4642	1/2" Drive Deep Socket, 12 Pt.	1-5/16"
4130	1/2" Drive Standard Socket, 12 Pt.	15/16"	4616	1/2" Drive Deep Socket, 12 Pt.	1/2"	4644	1/2" Drive Deep Socket, 12 Pt.	1-3/8"
4132	1/2" Drive Standard Socket, 12 Pt.	1"	4618	1/2" Drive Deep Socket, 12 Pt.	9/16"	4646	1/2" Drive Deep Socket, 12 Pt.	1-7/16"
4134	1/2" Drive Standard Socket, 12 Pt.	1-1/16"	4620	1/2" Drive Deep Socket, 12 Pt.	5/8"	4648	1/2" Drive Deep Socket, 12 Pt.	1-1/2"
4136	1/2" Drive Standard Socket, 12 Pt.	1-1/8"	4622	1/2" Drive Deep Socket, 12 Pt.	11/16"			
4138	1/2" Drive Standard Socket, 12 Pt.	1-3/16"	4624	1/2" Drive Deep Socket, 12 Pt.	3/4"			





Metric Sockets

D958 – 61 Pieces, 1/2" & 3/4" Drive 12 Pt.

Sockets

See Page 371 for photograph.

Part No.	Description	Size	Part No.	Description	Size	Part No.	Description	Size
41-09mm	1/2" Drive Metric Standard Socket, 12 Pt.	9mm	41-36mm	1/2" Drive Metric Standard Socket, 12 Pt.	36mm	61-24mm	3/4" Drive Metric Standard Socket, 12 Pt.	24mm
41-10mm	1/2" Drive Metric Standard Socket, 12 Pt.	10mm	42-06mm	1/2" Drive Metric Hex Bit Socket	6mm	61-25mm	3/4" Drive Metric Standard Socket, 12 Pt.	25mm
41-11mm	1/2" Drive Metric Standard Socket, 12 Pt.	11mm	42-08mm	1/2" Drive Metric Hex Bit Socket	8mm	61-26mm	3/4" Drive Metric Standard Socket, 12 Pt.	26mm
41-12mm	1/2" Drive Metric Standard Socket, 12 Pt.	12mm	42-10mm	1/2" Drive Metric Hex Bit Socket	10mm	61-27mm	3/4" Drive Metric Standard Socket, 12 Pt.	27mm
41-13mm	1/2" Drive Metric Standard Socket, 12 Pt.	13mm	42-12mm	1/2" Drive Metric Hex Bit Socket	12mm	61-28mm	3/4" Drive Metric Standard Socket, 12 Pt.	28mm
41-14mm	1/2" Drive Metric Standard Socket, 12 Pt.	14mm	42-14mm	1/2" Drive Metric Hex Bit Socket	14mm	61-29mm	3/4" Drive Metric Standard Socket, 12 Pt.	29mm
41-15mm	1/2" Drive Metric Standard Socket, 12 Pt.	15mm	42-17mm	1/2" Drive Metric Hex Bit Socket	17mm	61-30mm	3/4" Drive Metric Standard Socket, 12 Pt.	30mm
41-16mm	1/2" Drive Metric Standard Socket, 12 Pt.	16mm	46-15mm	1/2" Drive Metric Deep Socket, 12 Pt.	15mm	61-32mm	3/4" Drive Metric Standard Socket, 12 Pt.	32mm
41-17mm	1/2" Drive Metric Standard Socket, 12 Pt.	17mm	46-17mm	1/2" Drive Metric Deep Socket, 12 Pt.	17mm	61-35mm	3/4" Drive Metric Standard Socket, 12 Pt.	35mm
41-18mm	1/2" Drive Metric Standard Socket, 12 Pt.	18mm	46-18mm	1/2" Drive Metric Deep Socket, 12 Pt.	18mm	61-36mm	3/4" Drive Metric Standard Socket, 12 Pt.	36mm
41-19mm	1/2" Drive Metric Standard Socket, 12 Pt.	19mm	46-19mm	1/2" Drive Metric Deep Socket, 12 Pt.	19mm	61-38mm	3/4" Drive Metric Standard Socket, 12 Pt.	38mm
41-20mm	1/2" Drive Metric Standard Socket, 12 Pt.	20mm	46-20mm	1/2" Drive Metric Deep Socket, 12 Pt.	20mm	61-41mm	3/4" Drive Metric Standard Socket, 12 Pt.	41mm
41-21mm	1/2" Drive Metric Standard Socket, 12 Pt.	21mm	46-21mm	1/2" Drive Metric Deep Socket, 12 Pt.	21mm	61-42mm	3/4" Drive Metric Standard Socket, 12 Pt.	42mm
41-22mm	1/2" Drive Metric Standard Socket, 12 Pt.	22mm	46-22mm	1/2" Drive Metric Deep Socket, 12 Pt.	22mm	61-46mm	3/4" Drive Metric Standard Socket, 12 Pt.	46mm
41-23mm	1/2" Drive Metric Standard Socket, 12 Pt.	23mm	46-24mm	1/2" Drive Metric Deep Socket, 12 Pt.	24mm	61-50mm	3/4" Drive Metric Standard Socket, 12 Pt.	50mm
41-24mm	1/2" Drive Metric Standard Socket, 12 Pt.	24mm	46-25mm	1/2" Drive Metric Deep Socket, 12 Pt.	25mm	61-54mm	3/4" Drive Metric Standard Socket, 12 Pt.	54mm
41-25mm	1/2" Drive Metric Standard Socket, 12 Pt.	25mm	46-26mm	1/2" Drive Metric Deep Socket, 12 Pt.	26mm	61-55mm	3/4" Drive Metric Standard Socket, 12 Pt.	55mm
41-26mm	1/2" Drive Metric Standard Socket, 12 Pt.	26mm	61-19mm	3/4" Drive Metric Standard Socket, 12 Pt.	19mm	61-58mm	3/4" Drive Metric Standard Socket, 12 Pt.	58mm
41-27mm	1/2" Drive Metric Standard Socket, 12 Pt.	27mm	61-21mm	3/4" Drive Metric Standard Socket, 12 Pt.	21mm	61-60mm	3/4" Drive Metric Standard Socket, 12 Pt.	60mm
41-30mm	1/2" Drive Metric Standard Socket, 12 Pt.	30mm	61-22mm	3/4" Drive Metric Standard Socket, 12 Pt.	22mm			
41-32mm	1/2" Drive Metric Standard Socket, 12 Pt.	32mm	61-23mm	3/4" Drive Metric Standard Socket, 12 Pt.	23mm			

Fractional Sockets, Handles & Attachments

D949 – 16 Pieces, 3/4" Drive 12 Pt. Sockets,

Handles & Attachments

See Page 372 for photograph.

Part No.	Description	Size	Part No.	Description	Size	Part No.	Description	Size
6124	3/4" Drive Standard Socket, 12 Pt.	3/4"	6136	3/4" Drive Standard Socket, 12 Pt.	1-1/8"	6416	3/4" Drive 16" Extension	
6126	3/4" Drive Standard Socket, 12 Pt.	13/16"	6138	3/4" Drive Standard Socket, 12 Pt.	1-3/16"	6435	3/4" Drive Flex Handle	21-5/8"
6128	3/4" Drive Standard Socket, 12 Pt.	7/8"	6140	3/4" Drive Standard Socket, 12 Pt.	1-1/4"	6443	3/4" Drive Sliding T	17-1/2"
6130	3/4" Drive Standard Socket, 12 Pt.	15/16"	6400	3/4" Drive Ratchet, Knurled Steel Handle	24"	6475	3/4" Drive Universal	3-3/16"
6132	3/4" Drive Standard Socket, 12 Pt.	1"	6403	3/4" Drive 3-1/2" Extension				
6134	3/4" Drive Standard Socket, 12 Pt.	1-1/16"	6408	3/4" Drive 8" Extension				

Fractional Standard & Deep Sockets

D950 – 30 Pieces, 3/4" Drive 12 Pt. Standard

& Deep Sockets

See Page 372 for photograph.

Part No.	Description	Size	Part No.	Description	Size	Part No.	Description	Size
6142	3/4" Drive Standard Socket, 12 Pt.	1-5/16"	6164	3/4" Drive Standard Socket, 12 Pt.	2"	6532	3/4" Drive Deep Socket, 6 Pt.	1"
6144	3/4" Drive Standard Socket, 12 Pt.	1-3/8"	6166	3/4" Drive Standard Socket, 12 Pt.	2-1/16"	6534	3/4" Drive Deep Socket, 6 Pt.	1-1/16"
6146	3/4" Drive Standard Socket, 12 Pt.	1-7/16"	6168	3/4" Drive Standard Socket, 12 Pt.	2-1/8"	6536	3/4" Drive Deep Socket, 6 Pt.	1-1/8"
6148	3/4" Drive Standard Socket, 12 Pt.	1-1/2"	6170	3/4" Drive Standard Socket, 12 Pt.	2-3/16"	6538	3/4" Drive Deep Socket, 6 Pt.	1-3/16"
6150	3/4" Drive Standard Socket, 12 Pt.	1-9/16"	6172	3/4" Drive Standard Socket, 12 Pt.	2-1/4"	6540	3/4" Drive Deep Socket, 6 Pt.	1-1/4"
6152	3/4" Drive Standard Socket, 12 Pt.	1-5/8"	6176	3/4" Drive Standard Socket, 12 Pt.	2-3/8"	6542	3/4" Drive Deep Socket, 6 Pt.	1-5/16"
6154	3/4" Drive Standard Socket, 12 Pt.	1-11/16"	6524	3/4" Drive Deep Socket, 6 Pt.	3/4"	6544	3/4" Drive Deep Socket, 6 Pt.	1-3/8"
6156	3/4" Drive Standard Socket, 12 Pt.	1-3/4"	6526	3/4" Drive Deep Socket, 6 Pt.	1-3/16"	6546	3/4" Drive Deep Socket, 6 Pt.	1-7/16"
6158	3/4" Drive Standard Socket, 12 Pt.	1-13/16"	6528	3/4" Drive Deep Socket, 6 Pt.	7/8"	6548	3/4" Drive Deep Socket, 6 Pt.	1-1/2"
6160	3/4" Drive Standard Socket, 12 Pt.	1-7/8"	6530	3/4" Drive Deep Socket, 6 Pt.	15/16"	6552	3/4" Drive Deep Socket, 6 Pt.	1-5/8"





Fractional Sockets, Handles & Attachments

D951 – 24 Pieces, 1" Drive 12 Pt. Standard Sockets, Handles & Attachments

D952 – 13 Pieces, 1" Drive 12 Pt. Standard Sockets, Handles & Attachments

See Page 372 for photograph.

Part No.	Description	Size	Part No.	Description	Size	Part No.	Description	Size
D951			8162	1" Drive Standard Socket, 12 Pt.	1-15/16"	8180	1" Drive Standard Socket, 12 Pt.	2-1/2"
8134	1" Drive Standard Socket, 12 Pt.	1-1/16"	8164	1" Drive Standard Socket, 12 Pt.	2"	8182	1" Drive Standard Socket, 12 Pt.	2-9/16"
8136	1" Drive Standard Socket, 12 Pt.	1-1/8"	8168	1" Drive Standard Socket, 12 Pt.	2-1/8"	8184	1" Drive Standard Socket, 12 Pt.	2-5/8"
8138	1" Drive Standard Socket, 12 Pt.	1-3/16"	8170	1" Drive Standard Socket, 12 Pt.	2-3/16"	8188	1" Drive Standard Socket, 12 Pt.	2-3/4"
8140	1" Drive Standard Socket, 12 Pt.	1-1/4"	8172	1" Drive Standard Socket, 12 Pt.	2-1/4"	8190	1" Drive Standard Socket, 12 Pt.	2-13/16"
8142	1" Drive Standard Socket, 12 Pt.	1-5/16"	8174	1" Drive Standard Socket, 12 Pt.	2-5/16"	8194	1" Drive Standard Socket, 12 Pt.	2-15/16"
8144	1" Drive Standard Socket, 12 Pt.	1-3/8"	8400	1" Drive Ratchet, Knurled Steel Handle	30"	8196	1" Drive Standard Socket, 12 Pt.	3"
8146	1" Drive Standard Socket, 12 Pt.	1-7/16"	8408	1" Drive Extension	8"	8197	1" Drive Standard Socket, 12 Pt.	3-1/8"
8148	1" Drive Standard Socket, 12 Pt.	1-1/2"	8417	1" Drive Extension	17"	8198	1" Drive Standard Socket, 12 Pt.	2-3/8"
8152	1" Drive Standard Socket, 12 Pt.	1-5/8"	8435	1" Drive Flex Handle	26"	8199	1" Drive Standard Socket, 12 Pt.	3-1/2"
8154	1" Drive Standard Socket, 12 Pt.	1-11/16"	8443	1" Drive Sliding T	22"	8402	1" Drive Renewal Kit for 8400 & 8425 Ratchets	
8156	1" Drive Standard Socket, 12 Pt.	1-3/4"	D952					
8158	1" Drive Standard Socket, 12 Pt.	1-13/16"	8176	1" Drive Standard Socket, 12 Pt.	2-3/8"			
8160	1" Drive Standard Socket, 12 Pt.	1-7/8"	8178	1" Drive Standard Socket, 12 Pt.	2-7/16"			

Fractional Impact Sockets & Attachments

D953 – 55 Pieces, 1/2" Drive 6 & 12 Pt. Std. & Deep Impact Sockets & Attachments

See Page 373 for photograph.

Part No.	Description	Size	Part No.	Description	Size	Part No.	Description	Size
4800	1/2" Drive Impact Universal Joint	2-11/16"	4848	1/2" Drive Standard Impact Socket, 6 Pt.	1-1/2"	4926	1/2" Drive Deep Impact Socket, 6 Pt.	13/16"
4812	1/2" Drive Standard Impact Socket, 6 Pt.	3/8"	4864	1/2" Drive Standard Impact Socket, 12 Pt.	7/16"	4928	1/2" Drive Deep Impact Socket, 6 Pt.	7/8"
4814	1/2" Drive Standard Impact Socket, 6 Pt.	7/16"	4866	1/2" Drive Standard Impact Socket, 12 Pt.	1/2"	4930	1/2" Drive Deep Impact Socket, 6 Pt.	15/16"
4816	1/2" Drive Standard Impact Socket, 6 Pt.	1/2"	4868	1/2" Drive Standard Impact Socket, 12 Pt.	9/16"	4932	1/2" Drive Deep Impact Socket, 6 Pt.	1"
4818	1/2" Drive Standard Impact Socket, 6 Pt.	9/16"	4870	1/2" Drive Standard Impact Socket, 12 Pt.	5/8"	4934	1/2" Drive Deep Impact Socket, 6 Pt.	1-1/16"
4820	1/2" Drive Standard Impact Socket, 6 Pt.	5/8"	4872	1/2" Drive Standard Impact Socket, 12 Pt.	11/16"	4936	1/2" Drive Deep Impact Socket, 6 Pt.	1-1/8"
4822	1/2" Drive Standard Impact Socket, 6 Pt.	11/16"	4874	1/2" Drive Standard Impact Socket, 12 Pt.	3/4"	4940	1/2" Drive Deep Impact Socket, 6 Pt.	1-1/4"
4824	1/2" Drive Standard Impact Socket, 6 Pt.	3/4"	4900	1/2" Drive Impact Adaptor		4942	1/2" Drive Deep Impact Socket, 6 Pt.	1-5/16"
4826	1/2" Drive Standard Impact Socket, 6 Pt.	13/16"	4902	1/2" Drive Impact Adaptor		4944	1/2" Drive Deep Impact Socket, 6 Pt.	1-3/8"
4828	1/2" Drive Standard Impact Socket, 6 Pt.	7/8"	4903	1/2" Drive Impact Pin Lock Extensions	2"	4946	1/2" Drive Deep Impact Socket, 6 Pt.	1-7/16"
4830	1/2" Drive Standard Impact Socket, 6 Pt.	15/16"	4905	1/2" Drive Impact Ball Lock Extensions	5"	4948	1/2" Drive Deep Impact Socket, 6 Pt.	1-1/2"
4832	1/2" Drive Standard Impact Socket, 6 Pt.	1"	4909	1/2" Drive Impact Pin Lock Extensions	10"	4964	1/2" Drive Deep Impact Socket, 12 Pt.	7/16"
4834	1/2" Drive Standard Impact Socket, 6 Pt.	1-1/16"	4912	1/2" Drive Deep Impact Socket, 6 Pt.	3/8"	4966	1/2" Drive Deep Impact Socket, 12 Pt.	1/2"
4836	1/2" Drive Standard Impact Socket, 6 Pt.	1-1/8"	4914	1/2" Drive Deep Impact Socket, 6 Pt.	7/16"	4968	1/2" Drive Deep Impact Socket, 12 Pt.	9/16"
4838	1/2" Drive Standard Impact Socket, 6 Pt.	1-3/16"	4916	1/2" Drive Deep Impact Socket, 6 Pt.	1/2"	4970	1/2" Drive Deep Impact Socket, 12 Pt.	5/8"
4840	1/2" Drive Standard Impact Socket, 6 Pt.	1-1/4"	4918	1/2" Drive Deep Impact Socket, 6 Pt.	9/16"	4972	1/2" Drive Deep Impact Socket, 12 Pt.	11/16"
4842	1/2" Drive Standard Impact Socket, 6 Pt.	1-5/16"	4920	1/2" Drive Deep Impact Socket, 6 Pt.	5/8"	4974	1/2" Drive Deep Impact Socket, 12 Pt.	3/4"
4844	1/2" Drive Standard Impact Socket, 6 Pt.	1-3/8"	4922	1/2" Drive Deep Impact Socket, 6 Pt.	11/16"			
4846	1/2" Drive Standard Impact Socket, 6 Pt.	1-7/16"	4924	1/2" Drive Deep Impact Socket, 6 Pt.	3/4"			





Fractional Impact Sockets & Attachments

D985 – 44 Pieces, 3/4" Drive 6 & 12 Pt.

Standard Impact Sockets & Attachments

See Page 373 for photograph.

Part No.	Description	Size	Part No.	Description	Size	Part No.	Description	Size
6218	3/4" Drive Hex Bit Socket	9/16"	6820	3/4" Drive Standard Impact Socket, 6 Pt.	5/8"	6850	3/4" Drive Standard Impact Socket, 6 Pt.	1-9/16"
6220	3/4" Drive Hex Bit Socket	5/8"	6822	3/4" Drive Standard Impact Socket, 6 Pt.	11/16"	6852	3/4" Drive Standard Impact Socket, 6 Pt.	1-5/8"
6224	3/4" Drive Hex Bit Socket	3/4"	6824	3/4" Drive Standard Impact Socket, 6 Pt.	3/4"	6854	3/4" Drive Standard Impact Socket, 6 Pt.	1-11/16"
6228	3/4" Drive Hex Bit Socket	7/8"	6826	3/4" Drive Standard Impact Socket, 6 Pt.	13/16"	6856	3/4" Drive Standard Impact Socket, 6 Pt.	1-3/4"
6232	3/4" Drive Hex Bit Socket	1"	6828	3/4" Drive Standard Impact Socket, 6 Pt.	7/8"	6858	3/4" Drive Standard Impact Socket, 6 Pt.	1-13/16"
67H18	3/4" Drive Standard Impact Socket, 12 Pt.	9/16"	6830	3/4" Drive Standard Impact Socket, 6 Pt.	15/16"	6860	3/4" Drive Standard Impact Socket, 6 Pt.	1-7/8"
67H20	3/4" Drive Standard Impact Socket, 12 Pt.	5/8"	6832	3/4" Drive Standard Impact Socket, 6 Pt.	1"	6862	3/4" Drive Standard Impact Socket, 6 Pt.	1-15/16"
67H22	3/4" Drive Standard Impact Socket, 12 Pt.	11/16"	6834	3/4" Drive Standard Impact Socket, 6 Pt.	1-1/16"	6864	3/4" Drive Standard Impact Socket, 6 Pt.	2"
67H24	3/4" Drive Standard Impact Socket, 12 Pt.	3/4"	6836	3/4" Drive Standard Impact Socket, 6 Pt.	1-1/8"	6900	3/4" Drive Impact Adaptor	
67H26	3/4" Drive Standard Impact Socket, 12 Pt.	13/16"	6838	3/4" Drive Standard Impact Socket, 6 Pt.	1-3/16"	6901	3/4" Drive Impact Adaptor	
67H28	3/4" Drive Standard Impact Socket, 12 Pt.	7/8"	6840	3/4" Drive Standard Impact Socket, 6 Pt.	1-1/4"	6907	3/4" Drive Impact Extension	7"
67H30	3/4" Drive Standard Impact Socket, 12 Pt.	15/16"	6842	3/4" Drive Standard Impact Socket, 6 Pt.	1-5/16"	6910	3/4" Drive Impact Extension	10"
67H32	3/4" Drive Standard Impact Socket, 12 Pt.	1"	6844	3/4" Drive Standard Impact Socket, 6 Pt.	1-3/8"	6913	3/4" Drive Impact Extension	13"
6800	3/4" Drive Impact Universal Joint		6846	3/4" Drive Standard Impact Socket, 6 Pt.	1-7/16"	8900	1" Drive Impact Adaptor	
6818	3/4" Drive Standard Impact Socket, 6 Pt.	9/16"	6848	3/4" Drive Standard Impact Socket, 6 Pt.	1-1/2"			

Fractional Deep Impact Sockets

D986 – 33 Pieces, 3/4" Drive 6 & 12 Pt.

Deep Impact Sockets

See Page 373 for photograph.

Part No.	Description	Size	Part No.	Description	Size	Part No.	Description	Size
6918	3/4" Drive Deep Impact, 6 Pt.	9/16"	6940	3/4" Drive Deep Impact, 6 Pt.	1-1/4"	6962	3/4" Drive Deep Impact, 6 Pt.	1-15/16"
6920	3/4" Drive Deep Impact, 6 Pt.	5/8"	6942	3/4" Drive Deep Impact, 6 Pt.	1-5/16"	6964	3/4" Drive Deep Impact, 6 Pt.	2"
6922	3/4" Drive Deep Impact, 6 Pt.	11/16"	6944	3/4" Drive Deep Impact, 6 Pt.	1-3/8"	6968	3/4" Drive Deep Impact, 6 Pt.	2-1/8"
6924	3/4" Drive Deep Impact, 6 Pt.	3/4"	6946	3/4" Drive Deep Impact, 6 Pt.	1-7/16"	6969	3/4" Drive Deep Impact, 12 Pt.	9/16"
6926	3/4" Drive Deep Impact, 6 Pt.	13/16"	6948	3/4" Drive Deep Impact, 6 Pt.	1-1/2"	6970	3/4" Drive Deep Impact, 12 Pt.	5/8"
6928	3/4" Drive Deep Impact, 6 Pt.	7/8"	6950	3/4" Drive Deep Impact, 6 Pt.	1-9/16"	6972	3/4" Drive Deep Impact, 12 Pt.	11/16"
6930	3/4" Drive Deep Impact, 6 Pt.	15/16"	6952	3/4" Drive Deep Impact, 6 Pt.	1-5/8"	6974	3/4" Drive Deep Impact, 12 Pt.	3/4"
6932	3/4" Drive Deep Impact, 6 Pt.	1"	6954	3/4" Drive Deep Impact, 6 Pt.	1-11/16"	6976	3/4" Drive Deep Impact, 12 Pt.	13/16"
6934	3/4" Drive Deep Impact, 6 Pt.	1-1/16"	6956	3/4" Drive Deep Impact, 6 Pt.	1-3/4"	6978	3/4" Drive Deep Impact, 12 Pt.	7/8"
6936	3/4" Drive Deep Impact, 6 Pt.	1-1/8"	6958	3/4" Drive Deep Impact, 6 Pt.	1-13/16"	6980	3/4" Drive Deep Impact, 12 Pt.	15/16"
6938	3/4" Drive Deep Impact, 6 Pt.	1-3/16"	6960	3/4" Drive Deep Impact, 6 Pt.	1-7/8"	6982	3/4" Drive Deep Impact, 12 Pt.	1"





Screwdrivers

D973 – 28 Pieces, Jumbo Three-flute

Ergonomic Handle

See Page 374 for photograph.

Part No.	Description	Size	Part No.	Description	Size	Part No.	Description	Size
9101	Phillips Screwdriver #2	1-1/2"	9114	Cabinet Tip Screwdriver, 3/16"	3"	9127	Round Shank Screwdriver, 3/8"	10"
9103	Phillips Screwdriver #0	3"	9115	Cabinet Tip Screwdriver, 3/16"	4"	9128	Round Shank Screwdriver, 3/8"	12"
9104	Phillips Screwdriver #1	3"	9116	Cabinet Tip Screwdriver, 3/16"	6"	9132	Square Shank Screwdriver, 1/4"	4"
9105	Phillips Screwdriver #2	4"	9117	Cabinet Tip Screwdriver, 3/16"	8"	9133	Square Shank Screwdriver, 1/4"	6"
9106	Phillips Screwdriver #3	6"	9118	Cabinet Tip Screwdriver, 1/4"	10"	9134	Square Shank Screwdriver, 5/16"	6"
9107	Phillips Screwdriver #1	8"	9122	Round Shank Screwdriver, 1/4"	1-1/2"	9135	Square Shank Standard Tip, 3/8"	8"
9108	Phillips Screwdriver #2	8"	9123	Round Shank Screwdriver, 1/4"	4"	9136	Square Shank Standard Tip, 3/8"	10"
9109	Phillips Screwdriver #4	8"	9124	Round Shank Screwdriver, 1/4"	6"	9137	Square Shank Standard Tip, 3/8"	12"
9112	Cabinet Tip Screwdriver, 1/8"	3"	9125	Round Shank Screwdriver, 5/16"	6"			
9113	Cabinet Tip Screwdriver, 1/8"	5"	9126	Round Shank Screwdriver, 3/8"	8"			

Screwdrivers

D974 – 23 Pieces, Large Cushion Grip

Handle

See Page 374 for photograph.

Part No.	Description	Size	Part No.	Description	Size	Part No.	Description	Size
9141	Cushion Grip Phillips Screwdriver #2	Stubby	9154	Cushion Grip Round Shank Screwdriver 5/16"	6"	9166	Cushion Grip Cabinet Tip Screwdriver 1/4"	10"
9143	Phillips Screwdriver #1	3"	9155	Cushion Grip Round Shank Screwdriver 3/8"	8"	9172	Cushion Grip Square Shank Screwdriver 1/4"	4"
9144	Phillips Screwdriver #2	4"	9156	Cushion Grip Round Shank Screwdriver 3/8"	10"	9173	Cushion Grip Square Shank Screwdriver 1/4"	6"
9145	Phillips Screwdriver #3	6"	9157	Cushion Grip Round Shank Screwdriver 3/8"	12"	9174	Cushion Grip Square Shank Screwdriver 5/16"	6"
9146	Phillips Screwdriver #4	8"	9162	Cushion Grip Cabinet Tip Screwdriver 3/16"	3"	9175	Cushion Grip Square Shank Screwdriver 3/8"	8"
9151	Cushion Grip Round Shank Screwdriver 1/4"	1-1/2"	9163	Cushion Grip Cabinet Tip Screwdriver 3/16"	4"	9176	Cushion Grip Square Shank Screwdriver 3/8"	10"
9152	Cushion Grip Round Shank Screwdriver 1/4"	4"	9164	Cushion Grip Cabinet Tip Screwdriver 3/16"	6"	9177	Cushion Grip Square Shank Screwdriver 3/8"	12"
9153	Cushion Grip Round Shank Screwdriver 1/4"	6"	9165	Cushion Grip Cabinet Tip Screwdriver 3/16"	8"			

Hammers

D962 – 10 Pieces, Nupla®

Hammers

See Page 375 for photograph.

Part No.	Description	Weight
9021	Rubber Mallet, Fiberglass Handle	1 Lb.
9028	Brass Hammer, Fiberglass Handle	1.5 Lbs.
9029	Brass Hammer with Super Grip	2.5 Lbs.
9040	Ball Peen Hammer, Fiberglass Handle	8 Oz.
9041	Ball Peen Hammer, Fiberglass Handle	12 Oz.
9042	Ball Peen Hammer, Fiberglass Handle	16 Oz.
9043	Ball Peen Hammer, Fiberglass Handle	20 Oz.
9044	Ball Peen Hammer, Fiberglass Handle	24 Oz.
9045	Ball Peen Hammer, Fiberglass Handle	32 Oz.
9052	Small Drilling Hammer, Fiberglass Handle	3 Lbs.

Hammers

D963 – 7 Pieces, Nupla®

Hammers

See Page 375 for photograph.

Part No.	Description	Weight
9023	Dead Blow Hammer with Super Grip	1 Lb.
9024	Dead Blow Hammer with Super Grip	2 Lbs.
9025	Dead Blow Hammer with Super Grip	3 Lbs.
9026	Dead Blow Hammer with Super Grip	4 Lbs.
9030	Soft Face Hammer, 1-1/4" Tip Dia.	12 Oz.
9031	Soft Face Hammer, 1-3/8" Tip Dia.	21 Oz.
9032	Soft Face Hammer, 1-3/4" Tip Dia.	32 Oz.

Pliers

D969 – 10 Pieces, Channellock® Pliers

See Page 375 for photograph.

Part No.	Description	Size
9C317	Long Nose Plier w/Side Cutter	7-1/2"
9C318	Long Nose Plier w/Side Cutter	8"
9C326	Long Nose Plier w/Side Cutter	6"
9C386	Curved Long Nose Plier w/Serrated Jaws	6"
9C420	Tongue & Groove Plier	9-1/2"
9C424	Tongue & Groove Plier	4-1/2"
9C426	Tongue & Groove Plier	6-1/2"
9C430	Tongue & Groove Plier	10"
9C440	Tongue & Groove Plier	12"
9C460	Tongue & Groove Plier	16"





Pliers

D970 – 9 Pieces,
Channellock® Pliers
See Page 375 for photograph.

Part No.	Description	Size
9C337	Cutting Plier, Lap Joint	7"
9C347	Linesman Plier, Round Nose	7"
9C348	Linesman Plier, Round Nose	8"
9C350S	Ironworkers Plier	9"
9C357	Cutting Plier, Nipper	7"
9C436	Cutting Plier, Box Joint	6"
9C437	Cutting Plier, Lap Joint	7"
9C447	Cutting Plier, Curved Diagonal, Box Joint	7-3/4"
9C526	Slip Joint Plier, Wire Cutting Shear	6"

Vise Grip®

D965 – 6 Pieces
See Page 376 for photograph.

Part No.	Description	Size
9V11R	Locking C-Clamp Plier	11"
9V11SP	Locking C-Clamp Plier w/Swivel Pads	11"
9V6R	Locking C-Clamp Plier	6"
9V6SP	Locking C-Clamp Plier w/Swivel Pads	6"
9V8R	Locking Sheet Metal Tool	8"
9V9R	Locking Welding Clamp Plier	9"

Vise Grip®

D966 – 11 Pieces
See Page 376 for photograph.

Part No.	Description	Size
9V10CR	Curved Jaw Locking Plier	10"
9V10R	Straight Jaw Locking Plier	10"
9V10WR	Locking Wrench Plier Vise Grip	10"
9V4LN	Long Nose w/Wire Cutter Locking Plier	4"
9V4WR	Curved Jaw w/Wire Cutter Locking Plier	4"
9V5WR	Curved Jaw w/Wire Cutter Locking Plier	5"
9V6LN	Long Nose w/Wire Cutter Locking Plier	6"
9V7CR	Curved Jaw Locking Plier	7"
9V7R	Straight Jaw Locking Plier	7"
9V7WR	Curved Jaw w/Wire Cutter Locking Plier	7"
9V9LN	Long Nose w/Wire Cutter Locking Plier	9"

Midwest®/Hyde®

D967 – 9 Pieces
See Page 376 for photograph.

Part No.	Description	Size
9488	Scraper, Flexible Blade	1-1/4"
9489	Scraper, Flexible Blade	3"
9491	Scraper, Stiff Blade	1-1/4"
9526	Top-Slide Utility Knife	
9P6716L	Aviation Snips, Cuts Left, Red	10"
9P6716R	Aviation Snips, Cuts Right, Green	10"
9P6716S	Aviation Snips, Cuts Straight, Yellow	10"
9P6510L	Offset Snips, Cuts Left	
9P6510R	Offset Snips, Cuts Right	

C-Clamps

D971 – 5 Pieces
See Page 376 for photograph.

Part No.	Description
90402C	Deep Throat Forged Steel Body Clamps
90403C	Deep Throat Forged Steel Body Clamps
90404C	Deep Throat Forged Steel Body Clamps
90406C	Deep Throat Forged Steel Body Clamps
90408C	Deep Throat Forged Steel Body Clamps

Torx Bits, Sockets & Hex Key Sets

D968 – 31 Pieces
See Page 376 for photograph.

Part No.	Description	Size	Part No.	Description	Size	Part No.	Description	Size
9250	1/4" Drive E-6 Torx Socket	1-1/16" Long	9275	1/4" Drive T-25 Torx Bit Hex	1-1/16" Long	9288	1/2" Drive T-55 Torx Hex Driver	1-1/8" Long
9251	1/4" Drive E-7 Torx Socket	1-1/16" Long	9276	1/4" Drive T-27 Torx Bit Hex	1-1/16" Long	9290	3/8" Drive 5/16" Torx Hex Bit Holder	1-1/4" Long
9252	1/4" Drive E-8 Torx Socket	1-1/16" Long	9277	1/4" Drive T-30 Torx Bit Hex	1-1/16" Long	9291	1/2" Drive Torx Bit Holder	1-1/2" Long
9255	3/8" Drive E-10 Torx Socket	1-1/4" Long	9280	1/4" Drive Torx Bit Holder	1" Long	9292	3/8" Drive 7/16" Torx Hex Bit Holder	1-1/2" Long
9256	3/8" Drive E-12 Torx Socket	1-1/4" Long	9281	5/16" Drive 6mm Ribs Torx Bit	1-1/8" Long	9295	Torx Set - 8 Pieces	
9257	3/8" Drive E-14 Torx Socket	1-1/4" Long	9282	5/16" Drive T-30 Torx Bit	1-1/8" Long	9296	Torx Set - 7 Pieces	
9258	3/8" Drive E-16 Torx Socket	1-1/4" Long	9283	5/16" Drive T-40 Torx Bit	1-1/8" Long	9297	Torx Set - 7 Pieces	
9271	1/4" Drive T-8 Torx Bit Hex	1-1/16" Long	9284	5/16" Drive T-45 Torx Bit	1-1/8" Long	9E10113	Hex Set, L-Key, Metric Short Arm - 9 Pieces	
9272	1/4" Drive T-10 Torx Bit Hex	1-1/16" Long	9285	5/16" Drive T-47 Torx Bit	1-1/8" Long	9E69210	Hex Set, L-Key, Short Arm - 13 Pieces	
9273	1/4" Drive T-15 Torx Bit Hex	1-1/16" Long	9286	5/16" Drive T-50 Torx Bit	1-1/8" Long			
9274	1/4" Drive T-20 Torx Bit Hex	1-1/16" Long	9287	1/2" Drive T-55 Torx Bit Hex	1-1/8" Long			





Wright Tool Numerical Index

Wright Tool No.	Page No.	Wright Tool No.	Page No.	Wright Tool No.	Page No.	Wright Tool No.	Page No.	Wright Tool No.	Page No.
10-10MM	85, 141	11-19MM	75	1184	74	1312	79	1464	86
10-11MM	85, 141	11-20MM	75	1188	74	1314	79	1468	86
10-12MM	85, 141	11-21MM	75	1190	75, 78	1316	79	1472	86
10-13MM	85, 141	11-22MM	75	1192	75, 78	1318	79	150	21
10-14MM	85, 141	11-23MM	75	1194	75, 78	1320	79	152	21
10-15MM	85, 141	11-24MM	75	1196	75, 78	1322	79	16-11MM	83
10-16MM	85, 141	11-25MM	75	1198	75, 78	1324	79	16-12MM	83
10-17MM	85, 141	11-26MM	75	12-06MM	77	1325	79	16-14MM	83
10-18MM	85, 141	11-27MM	75	12-07MM	77	1326	79	16-17MM	83
10-19MM	85, 141	11-28MM	75	12-08MM	77	1328	79	16-21MM	83
101	13	11-29MM	75	12-09MM	77	1329	79	160	22
1012	85, 141	11-30MM	75	12-10MM	77	1330	79	161	22
1014	85, 141	11-32MM	75	12-11MM	77	1331	79	1614	83
1016	85, 141	11-36MM	76	12-12MM	77	1332	79	1618	83
1018	85, 141	11-41MM	76	12-13MM	77	1336	79	1622	83
102	13	11-46MM	76	12-14MM	77	1340	79	1628	83
1020	85, 141	11-50MM	76	12-15MM	77	1341	79	1640	72
1022	85, 141	11-55MM	76	12-16MM	77	1342	79	1642	84
1024	85, 141	11-60MM	76	12-17MM	77	1346	79	1644	84
1026	85, 141	11-65MM	76	12-18MM	77	135	19	1646	84
1028	85, 141	11-70MM	76	12-19MM	77	1352	79	1648	84
1032	85, 141	11-75MM	76	12-20MM	77	136	19	165	23
1040	83	11-80MM	76	12-21MM	77	1361	81	1650	84
1042	83	11X00	75, 78	12-22MM	77	1362	81	1652	84
1044	83	11X04	75, 78	12-23MM	77	1364	81	1654	84
1046	83	11X08	75, 78	12-24MM	77	1366	81	1656	84
1048	83	11X12	75, 78	12-25MM	77	1368	81	1658	84
105	14	11X16	75, 78	12-26MM	77	1370	81	166	23
1050	83	11X20	75, 78	12-27MM	77	1372	81	1660	84
1052	83	11X24	75, 78	12-30MM	77	1374	81	1662	84
1060	85, 142	11X28	75, 78	12-32MM	77	1376	81	170	24
1062	85, 142	1108	74	1208	76	1378	81	171	24
1064	85, 142	1110	74	121	16	1380	81	1726	90
1066	85, 142	1112	74	1210	76	1382	81	1728	90
1068	85, 142	1114	74	1212	76	1383	81	1730	90
107	14	1116	74	1214	76	1384	81	1732	90
1070	85, 142	1118	74	1216	76	1385	81	1734	90
1072	85, 142	112	15	1218	76	1386	81	1736	90
1074	85, 142	1120	74	122	76	1388	81	1740	90
1080	86, 177	1122	74	1220	76	1389	81	1742	90
1081	86, 177	1124	74	1222	76	1390	81	1746	90
1082	86, 177	1126	74	1224	76	1392	81	1748	90
1083	86, 177	1128	74	1226	76	1393	81	1752	90
1084	86, 177	113	15	1228	76	1394	81	1756	91
1085	86, 177	1130	74	1230	76	1395	81	1758	91
1086	86, 177	1132	74	1232	76	1396	81	1760	91
1087	86, 177	1134	74	1234	76	1398	81	1762	91
1088	86, 177	1136	74	1236	76	140	20	1764	91
1089	86, 177	1138	74	1238	76	141	20	1766	91
1090	86, 177	1140	74	1240	76	1424	86	1770	91
1091	86, 177	1142	74	125	17	1426	86	1772	91
1092	86, 177	1144	74	126	17	1428	86	1776	91
1093	86, 177	1146	74	13	49	1430	86	1778	91
1094	86, 177	1148	74	13-0607MM	80	1432	86	1782	91
11	49	1150	74	13-0708MM	80	1434	86	1784	91
11-06MM	75	1152	74	13-0809MM	80	1436	86	1788	91
11-07MM	75	1154	74	13-1011MM	80	1438	86	1790	91
11-08MM	75	1156	74	13-1213MM	80	1440	86	1794	91
11-09MM	75	1158	74	13-1415MM	80	1442	86	1795	91
11-10MM	75	1160	74	13-1617MM	80	1444	86	1796	91
11-11MM	75	1164	74	13-1819MM	80	1446	86	1797	91
11-12MM	75	1166	74	13-2022MM	80	1448	86	1798	91
11-13MM	75	1168	74	13-2123MM	80	1450	86	180	25
11-14MM	75	1170	74	13-2426MM	80	1452	86	181	25
11-15MM	75	1172	74	130	18	1456	86	1832	93
11-16MM	75	1176	74	1308	79	1458	86	1834	93
11-17MM	75	1180	74	131	18	1460	86	1836	93
11-18MM	75	1182	74	1310	79	1462	86	1838	93





Wright Tool Numerical Index

Wright Tool No.	Page No.	Wright Tool No.	Page No.	Wright Tool No.	Page No.	Wright Tool No.	Page No.	Wright Tool No.	Page No.
1840.....	93	1956.....	94	2204B.....	115	25-13MM.....	112	31-16MM.....	146
1842.....	93	1958.....	94	2205.....	115	2506.....	111	31-17MM.....	146
1844.....	93	1960.....	94	2205B.....	115	2507.....	111	31-18MM.....	146
1846.....	93	1962.....	94	2206.....	115	2508.....	111	31-19MM.....	146
1848.....	93	1964.....	94	2206B.....	115	2509.....	111	31-20MM.....	146
185.....	26	1968.....	94	2207.....	115	2510.....	111	31-21MM.....	146
1852.....	93	1970.....	94	2207B.....	115	2511.....	111	31-22MM.....	146
1854.....	93	1972.....	94	2208.....	115	2512.....	111	3108.....	146
1856.....	93	1974.....	94	2208B.....	115	2514.....	111	311.....	125
1858.....	93	1976.....	94	2210.....	115	2516.....	111	3110.....	146
186.....	26	1980.....	94	2210B.....	115	256.....	106	31108.....	77
1860.....	93	1982.....	94	2212.....	115	257.....	107	31110.....	77
1864.....	93	1984.....	94	2212B.....	115	2606.....	113	31112.....	77
1866.....	93	1988.....	94	2214.....	115	2607.....	113	31114.....	77
1868.....	93	1989.....	94	2214B.....	115	2608.....	113	31116.....	77
1870.....	93	199.....	30	2218.....	115	2609.....	113	31118.....	77
1872.....	93	1992.....	94	2260.....	115	2610.....	113	3112.....	146
1874.....	93	1996.....	94	2260B.....	115	2611.....	113	31120.....	77
1876.....	93	1997.....	94	2261.....	115	2612.....	113	31122.....	77
1880.....	93	20-04MM.....	111	2261B.....	115	2614.....	113	31124.....	77
1882.....	93	20-05MM.....	111	2263.....	115	2616.....	113	31126.....	77
1884.....	93	20-05.5MM.....	111	2263B.....	115	2618.....	113	31128.....	77
1886.....	93	20-06MM.....	111	2265.....	116	2708.....	113	31130.....	77
1888.....	93	20-07MM.....	111	2265B.....	116	2710.....	113	31132.....	77
1889.....	93	20-08MM.....	111	2266.....	116	2712.....	113	31134.....	77
1889A.....	93	20-09MM.....	111	2266B.....	116	2714.....	113	31136.....	77
189.....	27	20-10MM.....	111	2267.....	116	2716.....	113	31138.....	77
1890.....	93	20-11MM.....	111	2267B.....	116	299.....	50	3114.....	146
1890A.....	93	20-12MM.....	111	2268B.....	116	30-06MM.....	143	31140.....	77
1891.....	93	20-13MM.....	111	23.....	49	30-07MM.....	143	31142.....	78
1891A.....	93	20-14MM.....	111	2308.....	112	30-08MM.....	143	31144.....	78
1892.....	93	200.....	104	2310.....	112	30-09MM.....	143	31146.....	78
1894.....	93	2005.....	111	2312.....	112	30-10MM.....	143	31148.....	78
1895.....	93	2006.....	111	236.....	104	30-11MM.....	143	31152.....	78
1896.....	93	2007.....	111	237.....	50	30-12MM.....	143	31154.....	78
1897.....	93	2008.....	111	2401.....	108	30-13MM.....	143	31156.....	78
19-32MM.....	95	2009.....	111	2402.....	109	30-14MM.....	143	31158.....	78
19-36MM.....	95	2010.....	111	2404.....	109	30-15MM.....	143	3116.....	146
19-41MM.....	95	2011.....	111	2406.....	109	30-16MM.....	143	31160.....	78
19-46MM.....	95	2012.....	111	2410.....	109	30-17MM.....	143	31164.....	78
19-50MM.....	95	2014.....	111	2413.....	110	30-18MM.....	143	31166.....	78
19-55MM.....	95	2016.....	111	2414.....	109	30-19MM.....	143	31168.....	78
19-60MM.....	95	205.....	107	2426.....	108	300.....	124	31170.....	78
19-65MM.....	95	207.....	107	2435.....	109	3008.....	143	31172.....	78
19-70MM.....	95	208.....	105	2441.....	109	3010.....	143	31176.....	78
19-75MM.....	95	209.....	105	2442.....	109	3012.....	143	3118.....	146
19-80MM.....	95	210.....	105	2445.....	110	3014.....	143	31180.....	78
190.....	28	2106.....	113	2453.....	110	3016.....	143	312.....	123
1900.....	92	2107.....	113	2462.....	253	3018.....	143	3120.....	146
191.....	28	2108.....	113	2463.....	253	3020.....	143	3122.....	146
19108.....	94	2109.....	113	2464.....	253	3022.....	143	3124.....	146
19112.....	94	2110.....	113	2470.....	248	3024.....	143	3126.....	146
19120.....	84	2111.....	113	2471.....	248	3026.....	143	3128.....	146
19124.....	94	2112.....	113	2473.....	251	3028.....	143	313.....	131
19132.....	94	2114.....	113	2475.....	110	3030.....	143	3130.....	146
19136.....	94	2116.....	113	2477.....	247	3032.....	143	3132.....	146
1932.....	94	2118.....	113	2492.....	108	304.....	123	314.....	132
1934.....	94	212.....	103	2493.....	108	305.....	125	316.....	125
1936.....	94	218.....	103	2495.....	108	306.....	126	31614.....	84
1938.....	94	22.....	49	25-04MM.....	112	308.....	126	31618.....	84
194.....	29	221.....	106	25-05MM.....	112	31-08MM.....	146	31622.....	84
1940.....	94	223.....	103	25-06MM.....	112	31-09MM.....	146	32-02MM.....	153
1942.....	94	224.....	106	25-07MM.....	112	31-10MM.....	146	32-02.5MM.....	153
1946.....	94	2202.....	115	25-08MM.....	112	31-11MM.....	146	32-03MM.....	153
1948.....	94	2202B.....	115	25-09MM.....	112	31-12MM.....	146	32-04MM.....	153
195.....	29	2203.....	115	25-10MM.....	112	31-13MM.....	146	32-05MM.....	153
1952.....	94	2203B.....	115	25-11MM.....	112	31-14MM.....	146	32-06MM.....	153
1954.....	94	2204.....	115	25-12MM.....	112	31-15MM.....	146	32-07MM.....	153





Wright Tool Numerical Index

Wright Tool No.	Page No.	Wright Tool No.	Page No.	Wright Tool No.	Page No.	Wright Tool No.	Page No.	Wright Tool No.	Page No.
32-08MM	153	32L-06MM	154	33108	149	34030	183	34532	183
32-10MM	153	32L-06MMB	154	33110	149	34032	183	34534	183
3204	153	32L-08MM	154	33112	149	34034	183	34536	183
3204B	153	32L-08MMB	154	33114	149	34036	183	3454	140
3205	153	32L-10MM	154	33116	149	34038	183	34540	183
3205B	153	32L-10MMB	154	33118	149	34040	183	346	119
3206	153	32B04	154	3312	145	34042	183	34612	184
3206B	153	32B04B	154	33120	149	34044	183	34614	184
3207	153	32B05	154	33122	149	34046	183	34616	184
3207B	153	32B05B	154	33124	149	34048	183	34618	184
3208	153	32B06	154	33126	149	3405	139	34620	184
3208B	153, 189	32B06B	154	33128	149	3408	139	34622	184
3210	153	32B07	154	33130	149	3409	139	34624	184
3210B	115, 153, 189	32B07B	154	33132	149	3410	139	34626	184
32106	114	32B08	154	3314	145	3411	139	34628	184
32107	114	32B08B	154	3316	145	34112	184	34630	184
32108	114	32B10	154	3318	145	34114	184	34632	184
32109	114	32B10B	154	332	133	34116	184	34634	184
32110	114	32B12	154	3320	145	34118	184	34636	184
32111	114	32B12B	154	3322	145	3412	139	34638	184
32112	114	32BM02B	154	3324	145	34120	184	34640	184
32114	114	32BM02.5B	154	3326	145	34122	184	34642	184
32116	114	32BM03B	154	3328	145	34124	184	34644	184
32118	114	32BM04B	154	333	133	34126	184	34646	184
3212	153	32BM05B	154	334	121	34128	184	34648	184
3212B	153	32BM06B	154	33426	137	3413	140	3470	248
32401	108	32BM07B	154	33430	137	34130	184	3471	248
32426	108	32BM08B	154	33435	138	34132	184	3472	248
3260	155	32BM10B	154	33491	137	34134	184	3473	248
3260B	155	32L04	154	335	121	34136	184	3474	251
32606	114	32L04B	154	33508	148	34138	184	3475	141
32607	114	32L05	154	33510	148	34140	184	3477	247
32608	114	32L05B	154	33512	148	34142	184	3478	247
32609	114	32L06	154	33514	148	34144	184	3479	247
3261	155	32L06B	154	33516	148	34146	184	348	118
3261B	155	32L07	154	33518	148	34148	184	3480	137
32610	114	32L07B	154	33520	148	3422	139	3481	137
32611	114	32L08	154	33522	148	3424	139	3482	137
32612	114	32L08B	154	33524	148	3425	137	3483	137
32614	114	32L10	154	33526	148	3426	137	349	129
32616	114	32L10B	154	33528	148	3427	137	3490	137
32618	114	32L12	154	33530	148	3428	137	3491	137
3262	155	32L12B	154	33532	148	3429	137	35-06MM	144
3262B	155	32M02B	153	33612	149	3430	137	35-07MM	144
3265	155	32M02.5B	153	33614	149	3431	138	35-08MM	144
3265B	155	32M03B	153	33616	149	3432	137	35-09MM	144
3266	155	32M04B	153	33618	149	3433	137	35-10MM	144
3266B	155	32M05B	153	33620	149	3434	137	35-11MM	144
3267	155	32M06B	153, 189	33622	149	3435	138	35-12MM	144
3267B	155	32M07B	153	33624	149	3438	138	35-13MM	144
3268	155	32M08B	153, 189	33626	149	3439	138	35-14MM	144
3268B	155	32M10B	153	33628	149	3440	137	35-15MM	144
327	122	330	122	337	120	34426	173	35-16MM	144
328	123	33008	148	338	121	3443	139	35-17MM	144
329	122	33010	148	339	119	34435	174	35-18MM	144
32B-02MM	154	33012	148	340	120	3445	140	35-19MM	144
32B-02.5MM	154	33014	148	3400	137	3447	247	3508	144
32B-03MM	154	33016	148	34012	183	34491	173	351	134
32B-04MM	154	33018	148	34014	183	34514	183	3510	144
32B-05MM	154	33020	148	34016	183	34516	183	3512	144
32B-06MM	154	33022	148	34018	183	34518	183	3514	144
32B-07MM	154	33024	148	3402	139	3452	140	3516	144
32B-08MM	154	33026	148	34020	183	34520	183	3518	144
32B-10MM	154	33028	148	34022	183	34522	183	352	135
32L-04MM	154	33030	148	34024	183	34524	183	3520	144
32L-04MMB	154	33032	148	34026	183	34526	183	3522	144
32L-05MM	154	3308	145	34028	183	34528	183	3524	144
32L-05MMB	154	3310	145	3403	139	34530	183	3526	144





Wright Tool Numerical Index

Wright Tool No.	Page No.	Wright Tool No.	Page No.	Wright Tool No.	Page No.	Wright Tool No.	Page No.	Wright Tool No.	Page No.
3528.....	144	38-51MM.....	151	3962.....	152	4112.....	180	42L-06MM.....	190
353.....	130	38-52MM.....	151	3964.....	152	41120.....	79	42L-06MMB.....	190
3530.....	144	38-53MM.....	151	4012.....	178	41121.....	79	42L-08MM.....	190
3532.....	144	38-54MM.....	151	4014.....	178	41122.....	79	42L-08MMB.....	190
354.....	130	38-55MM.....	151	4016.....	178	41123.....	79	42L-10MM.....	190
355.....	130	38-56MM.....	151	4018.....	178	41124.....	79	42L-10MMB.....	190
356.....	133	38-57MM.....	151	402.....	162	4114.....	180	42L-12MM.....	190
357.....	134	38-58MM.....	151	4020.....	178	4115.....	180	42L-12MMB.....	190
358.....	135	38-59MM.....	151	4022.....	178	4118.....	180	42L-14MM.....	190
3588.....	144	3800.....	142	4024.....	178	4119.....	180	42L-14MMB.....	190
359.....	135	3810.....	150	4026.....	178	412.....	168	42L-17MM.....	190
3590.....	144	3812.....	150	4028.....	178	4120.....	180	42L-17MMB.....	190
3596.....	144	3814.....	150	403.....	168	4121.....	180	42L08.....	190
36-09MM.....	147	3816.....	150	4030.....	178	4122.....	180	42L08B.....	190
36-10MM.....	147	3818.....	150	4032.....	178	4124.....	180	42L10.....	190
36-11MM.....	147	3820.....	150	4034.....	178	4125.....	180	42L10B.....	190
36-12MM.....	147	3822.....	150	4036.....	178	4126.....	180	42L12.....	190
36-13MM.....	147	3824.....	150	4038.....	178	4128.....	180	42L12B.....	190
36-14MM.....	147	38400.....	219	4040.....	178	4129.....	180	42L14.....	190
36-15MM.....	147	38402.....	219	4042.....	178	4130.....	180	42L14B.....	190
36-17MM.....	147	3852.....	151	4044.....	178	4131.....	180	42L16.....	190
36-19MM.....	147	3854.....	151	4046.....	178	4132.....	180	42L16B.....	190
360.....	131	3856.....	151	4048.....	178	4134.....	180	42L18.....	190
361.....	131	3858.....	151	405.....	163	4136.....	180	42L18B.....	190
3612.....	147	3860.....	151	406.....	164	4138.....	180	42L20.....	190
3614.....	147	3862.....	151	407.....	168	414.....	163	42L20B.....	190
3616.....	147	3864.....	151	408.....	167	4140.....	180	42M10B.....	189
3618.....	147	3899.....	142	409.....	162	4142.....	180	42M12B.....	189
362.....	132	39-06MM.....	151	41-09MM.....	181	4144.....	180	42M14B.....	189
3620.....	147	39-07MM.....	151	41-10MM.....	181	4146.....	180	42M17B.....	189
3622.....	147	39-08MM.....	151	41-11MM.....	181	4148.....	180	4208.....	189
3624.....	147	39-09MM.....	151	41-12MM.....	181	415.....	167	4210.....	189
3626.....	147	39-10MM.....	151	41-13MM.....	181	416.....	161	4212.....	189
3628.....	147	39-11MM.....	151	41-14MM.....	181	417.....	160	4212B.....	189
363.....	134	39-12MM.....	151	41-15MM.....	181	418.....	160	4214.....	189
3630.....	147	39-13MM.....	151	41-16MM.....	181	419.....	161	4214B.....	189
3632.....	147	39-14MM.....	151	41-17MM.....	181	42-06MM.....	189	4216.....	189
364.....	128	39-15MM.....	151	41-18MM.....	181	42-08MM.....	189	4216B.....	189
36400.....	200	39-16MM.....	151	41-19MM.....	181	42-10MM.....	189	4218.....	189
36402.....	200	39-17MM.....	151	41-20MM.....	181	42-12MM.....	189	4218B.....	189
36435.....	200	39-18MM.....	151	41-21MM.....	181	42-14MM.....	189	422.....	160
366.....	129	39-19MM.....	151	41-22MM.....	181	42-17MM.....	189	4220.....	189
367.....	129	39-50MM.....	152	41-23MM.....	181	42B-06MM.....	190	4220B.....	189
3712.....	147	39-51MM.....	152	41-24MM.....	181	42B-08MM.....	190	423.....	159
3714.....	147	39-52MM.....	152	41-25MM.....	181	42B-10MM.....	190	424.....	158
3716.....	147	39-53MM.....	152	41-26MM.....	181	42B-12MM.....	190	425.....	159
3718.....	147	39-54MM.....	152	41-27MM.....	181	42B-14MM.....	190	427.....	158
3720.....	147	39-55MM.....	152	41-28MM.....	181	42B-17MM.....	190	4312.....	179
3722.....	147	39-56MM.....	152	41-29MM.....	181	42B08.....	190	4314.....	179
3724.....	147	39-57MM.....	152	41-30MM.....	181	42B08B.....	190	4316.....	179
377.....	128	39-58MM.....	152	41-32MM.....	181	42B10.....	190	4318.....	179
378.....	124	39-59MM.....	152	41-36MM.....	181	42B10B.....	190	4320.....	179
379.....	124	3903.....	142	410.....	162	42B12.....	190	4322.....	179
38-06MM.....	150	3906.....	142	411.....	167	42B12B.....	190	4324.....	179
38-07MM.....	150	3908.....	142	41106.....	79	42B14.....	190	4326.....	179
38-08MM.....	150	3910.....	150	41107.....	79	42B14B.....	190	4328.....	179
38-09MM.....	150	3912.....	150	41108.....	79	42B16.....	190	4330.....	179
38-10MM.....	150	3914.....	150	41109.....	79	42B16B.....	190	4332.....	179
38-11MM.....	150	3916.....	150	41110.....	79	42B18.....	190	4334.....	179
38-12MM.....	150	3918.....	150	41111.....	79	42B18B.....	190	4336.....	179
38-13MM.....	150	3920.....	150	41112.....	79	42B20.....	190	4340.....	179
38-14MM.....	150	3922.....	150	41113.....	79	42B20B.....	190	4400.....	173
38-15MM.....	150	3924.....	150	41114.....	79	42BM06B.....	190	4401.....	173
38-16MM.....	150	3952.....	152	41115.....	79	42BM08B.....	190	4402.....	175
38-17MM.....	150	3954.....	152	41116.....	79	42BM10B.....	190	4405.....	175
38-18MM.....	150	3956.....	152	41117.....	79	42BM12B.....	190	4409.....	175
38-19MM.....	150	3958.....	152	41118.....	79	42BM14B.....	190	4410.....	175
38-50MM.....	151	3960.....	152	41119.....	79	42BM17B.....	190	4413.....	176





Wright Tool Numerical Index

Wright Tool No.	Page No.	Wright Tool No.	Page No.	Wright Tool No.	Page No.	Wright Tool No.	Page No.	Wright Tool No.	Page No.
4420	175	46-20MM	182	4800	177	4910	177	54044	82
4422	177	46-21MM	182	4812	185	4912	187	54046	82
4425	173	46-22MM	182	4814	185	4914	187	54648	82
4426	173	46-24MM	182	4816	185	4916	187	54652	82
4427	173	46-25MM	182	4818	185	4918	187	5800	240
4428	91, 173	46-26MM	182	4820	185	4920	187	5828	241
4430	173	460	169	4822	185	4922	187	5830	241
4432	173	461	170	4824	185	4924	187	5832	241
4433	173	4612	182	4826	185	4926	187	5834	241
4434	174	4614	182	4828	185	4928	187	5836	241
4435	174	4616	182	4830	185	4930	187	5838	241
4437	174	4618	182	4832	185	4932	187	5840	241
4438	174	4620	182	4834	185	4934	187	5842	241
4439	174	4622	182	4836	185	4936	187	5844	241
4443	175	4624	182	4838	185	4938	187	5846	241
4445	175	4626	182	4840	185	4940	187	5848	241
4453	176	4628	182	4842	185	4942	187	5852	241
4470	249	4630	182	4844	185	4944	187	5856	241
4471	249	4632	182	4846	185	4946	187	5858	241
4474	251	4634	182	4848	185	4948	187	5860	241
4475	176	4636	182	4864	186	4964	187	5864	241
4476	247	4638	182	4866	186	4966	187	5901	240
4477	247	4640	182	4868	186	4968	187	5934	241
4478	247	4642	182	4870	186	4970	187	5936	241
4479	247	4644	182	4872	186	4972	187	5938	241
4480	173	4646	182	4874	186	4974	187	5940	241
4481	173	4648	182	4876	186	4976	187	5942	241
4482	173	466	169	4878	186	4978	187	5946	241
4490	173	467	169	4880	186	4980	187	5948	241
4491	173	469	165	4882	186	4982	187	5993	241
4494	173	472	165	4884	186	4984	187	5995	241
45	49	473	165	4886	186	4986	187	603	195
450	161	4772	185	4888	186	4988	187	604	196
4512	178	4774	185	4890	186	4990	187	606	197
4514	178	4776	185	4892	186	4990A	187	607	198
4516	178	4778	185	4894	186	4992	187	608	197
4518	178	4780	185	4896	186	4994	187	609	196
4520	178	4782	185	4898	186	4996	187	61-19MM	206
4522	178	4784	185	49-10MM	188	4998	187	61-21MM	206
4524	178	4786	185	49-11MM	188	50810MM	82	61-22MM	206
4526	178	4788	185	49-12MM	188	51011MM	82	61-23MM	206
4528	178	4790	185	49-13MM	188	51012	82	61-24MM	206
453	166	4792	185	49-14MM	188	51113MM	82	61-25MM	206
4530	178	4794	185	49-15MM	188	51213MM	82	61-26MM	206
4532	178	4796	185	49-16MM	188	51214	82	61-27MM	206
4534	178	48-10MM	186	49-17MM	188	51214MM	82	61-28MM	206
4536	178	48-11MM	186	49-18MM	188	51315MM	82	61-29MM	206
454	166	48-12MM	186	49-19MM	188	51415MM	82	61-30MM	206
4540	178	48-13MM	186	49-20MM	188	51416	82	61-31MM	206
4542	178	48-14MM	186	49-21MM	188	51618	82	61-32MM	206
4544	178	48-15MM	186	49-22MM	188	51618MM	82	61-35MM	206
4546	178	48-16MM	186	49-23MM	188	51719MM	82	61-36MM	206
4548	178	48-17MM	186	49-24MM	188	51820	82	61-38MM	206
455	170	48-18MM	186	49-27MM	188	51922MM	82	61-41MM	206
4590	179	48-19MM	186	49-29MM	188	52022	82	61-42MM	206
4596	179	48-20MM	186	49-30MM	188	52024	82	61-46MM	206
4598	179	48-21MM	186	49-31MM	188	52224	82	61-50MM	206
46-09MM	182	48-22MM	186	49-32MM	188	52224MM	82	61-54MM	206
46-10MM	182	48-23MM	186	49-34MM	188	52426	82	61-55MM	206
46-11MM	182	48-24MM	186	49-35MM	188	52428	82	61-58MM	206
46-12MM	182	48-25MM	186	49-36MM	188	52628	82	61-60MM	206
46-13MM	182	48-26MM	186	49E18	177	52830	82	610	196
46-14MM	182	48-27MM	186	49E24	177	52834	82	6124	205
46-15MM	182	48-28MM	186	4900	177	53032	82	6126	205
46-16MM	182	48-30MM	186	4902	177	53034	82	6128	205
46-17MM	182	48-32MM	186	4903	177	53436	82	6130	205
46-18MM	182	48-36MM	186	4905	177	53440	82	6132	205
46-19MM	182	48-91MM	188	4909	177	54042	82	6134	205





Wright Tool Numerical Index

Wright Tool No.	Page No.	Wright Tool No.	Page No.	Wright Tool No.	Page No.	Wright Tool No.	Page No.	Wright Tool No.	Page No.
6136.....	205	6530.....	205	67H72.....	207	6894.....	209	6976.....	212
6138.....	205	6532.....	205	67H76.....	207	6896.....	209	6978.....	212
614.....	194	6534.....	205	68-17MM.....	210	6898.....	209	6980.....	212
6140.....	205	6536.....	205	68-19MM.....	210	68100.....	109	6982.....	212
6142.....	205	6538.....	205	68-20MM.....	210	68102.....	109	6991.....	214
6144.....	205	6540.....	205	68-21MM.....	210	68104.....	109	6993.....	214
6146.....	205	6542.....	205	68-22MM.....	210	68106.....	109	69100.....	211
6148.....	205	6544.....	205	68-23MM.....	210	68108.....	109	69102.....	211
6150.....	205	6546.....	205	68-24MM.....	210	68110.....	109	69104.....	211
6152.....	205	6548.....	205	68-26MM.....	210	68112.....	109	69106.....	211
6154.....	205	6552.....	205	68-27MM.....	210	68114.....	109	69108.....	211
6156.....	205	6573.....	204	68-28MM.....	210	68116.....	109	69110.....	211
6158.....	205	6574.....	204	68-29MM.....	210	68118.....	109	69112.....	211
6160.....	205	6574.....	204	68-30MM.....	210	69-19MM.....	212	69114.....	211
6164.....	205	6576.....	204, 220	68-32MM.....	210	69-21MM.....	212	69116.....	211
6166.....	205	6577.....	204, 220	68-33MM.....	210	69-22MM.....	212	69118.....	211
6168.....	205	6578.....	204, 220	68-34MM.....	210	69-23MM.....	212	69120.....	211
6170.....	205	6580.....	204	68-35MM.....	210	69-24MM.....	212	69122.....	211
6172.....	205	6581.....	204	68-36MM.....	210	69-26MM.....	212	69124.....	211
6176.....	205	6581A.....	222	68-38MM.....	210	69-27MM.....	212	69126.....	211
618.....	194	6582.....	204	68-41MM.....	210	69-30MM.....	212	700.....	127
62-14MM.....	215	6582A.....	204	68-42MM.....	210	69-32MM.....	212	701.....	127
62-17MM.....	215	6582B.....	204	68-43MM.....	210	69-33MM.....	212	702.....	127
62-19MM.....	215	6582C.....	204	68-46MM.....	210	69-35MM.....	212	703.....	164
62-22MM.....	215	6582D.....	204	68-50MM.....	210	69-36MM.....	212	705.....	56
62-24MM.....	215	6583.....	222	68-87MM.....	215	69-38MM.....	212	707.....	56
62M14B.....	216	6584.....	222	68-91MM.....	215	69-41MM.....	212	707-ROLL.....	51
62M17B.....	216	6585.....	222	6800.....	202	69-43MM.....	212	711.....	56
62M19B.....	216	6586.....	222	6818.....	209	69-46MM.....	212	711-ROLL.....	51
62M22B.....	216	6587.....	222	6820.....	209	69-50MM.....	212	714.....	57
62M248.....	216	660.....	199	6822.....	209	69E24.....	203	714-ROLL.....	51
6218.....	215	67H-19MM.....	208	6824.....	209	69E36.....	203	715.....	57
6218B.....	215	67H-22MM.....	208	6826.....	209	6900.....	202	715-ROLL.....	51
6220.....	215	67H-24MM.....	208	6828.....	209	6901.....	202	720.....	61
6220B.....	215	67H-27MM.....	208	6830.....	209	6907.....	203	726.....	58
6224.....	215	67H-30MM.....	208	6832.....	209	6910.....	203	730.....	58
6224B.....	215	67H-32MM.....	208	6834.....	209	6913.....	203	732.....	66
6228.....	215	67H-36MM.....	208	6836.....	209	6918.....	211	732-ROLL.....	51
6228B.....	215	67H-41MM.....	208	6838.....	209	6920.....	211	733.....	67
623.....	193	67H-46MM.....	208	6840.....	209	6922.....	211	733-ROLL.....	51
6232.....	215	67H-50MM.....	208	6842.....	209	6924.....	211	734.....	67
6232B.....	215	67H-55MM.....	208	6844.....	209	6926.....	211	735.....	64
624.....	195	67H18.....	207	6846.....	209	6928.....	211	735-ROLL.....	51
625.....	194	67H20.....	207	6848.....	209	6930.....	211	736.....	65
631.....	193	67H22.....	207	6850.....	209	6932.....	211	736-ROLL.....	51
6400.....	200	67H24.....	207	6852.....	209	6934.....	211	737-ROLL.....	51
6402.....	200	67H26.....	207	6854.....	209	6936.....	211	738.....	68
6403.....	200	67H28.....	207	6856.....	209	6938.....	211	738-ROLL.....	51
6408.....	200	67H30.....	207	6858.....	209	6940.....	211	739.....	65
6416.....	200	67H32.....	207	6860.....	209	6942.....	211	739-ROLL.....	51
6425.....	200	67H34.....	207	6862.....	209	6944.....	211	740.....	66
6435.....	200	67H36.....	207	6864.....	209	6946.....	211	740-ROLL.....	51
6440.....	201	67H38.....	207	6865.....	213	6947.....	211	741.....	66
6441.....	201	67H40.....	207	6866.....	213	6948.....	211	741-ROLL.....	51
6443.....	201	67H42.....	207	6868.....	213	6950.....	211	742.....	69
6444.....	201	67H44.....	207	6870.....	213	6952.....	211	742-ROLL.....	51
6448.....	247	67H46.....	207	6872.....	213	6954.....	211	743.....	69
6450.....	201	67H48.....	207	6874.....	213	6956.....	211	743-ROLL.....	51
6470.....	248	67H50.....	207	6876.....	213	6958.....	211	744.....	69
6471.....	248	67H52.....	207	6878.....	213	6960.....	211	744-ROLL.....	51
6472.....	249	67H54.....	207	6880.....	213	6962.....	211	745.....	70
6473.....	252	67H56.....	207	6882.....	213	6964.....	211	745-ROLL.....	51
6475.....	201	67H58.....	207	6886.....	213	6966.....	211	746-ROLL.....	51
650.....	195	67H60.....	207	6888.....	216	6968.....	211	747.....	70
655.....	198	67H64.....	207	6889.....	216	6969.....	212	749.....	70
6524.....	205	67H66.....	207	6890.....	209	6970.....	212	750.....	59
6526.....	205	67H68.....	207	6892.....	209	6972.....	212	751.....	59
6528.....	205	67H70.....	207	6893.....	214	6974.....	212	751-ROLL.....	51





Wright Tool Numerical Index

Wright Tool No.	Page No.	Wright Tool No.	Page No.	Wright Tool No.	Page No.	Wright Tool No.	Page No.	Wright Tool No.	Page No.
752.....	60	84723.....	234	84844.....	233	84924.....	235	858-135MM.....	239
752-ROLL.....	51	84724.....	234	84845.....	233	84925.....	235	858-140MM.....	239
758.....	60	84727.....	234	84846.....	233	84926.....	235	858-145MM.....	239
758-ROLL.....	51	84728.....	234	84847.....	233	84927.....	235	858-150MM.....	239
760.....	61	8473.....	252	84848.....	233	84928.....	235	858-155MM.....	239
787.....	67	84733.....	234	84849.....	233	84929.....	235	858-160MM.....	239
788.....	68	84738.....	234	84850.....	233	84930.....	235	858-165MM.....	239
798.....	68	84743.....	234	84851.....	233	84931.....	235	858-170MM.....	239
799.....	68	84748.....	234	84852.....	233	84932.....	235	858-175MM.....	239
8134.....	223	84750.....	234	84853.....	233	84933.....	235	858-180MM.....	239
8136.....	223	848-100MM.....	234	84854.....	233	84934.....	235	858-185MM.....	239
8138.....	223	848-105MM.....	234	84855.....	233	84935.....	235	858-190MM.....	239
8140.....	223	848-110MM.....	234	84856.....	233	84936.....	235	858-200MM.....	239
8142.....	223	848-115MM.....	234	84857.....	233	84937.....	235	858-210MM.....	239
8144.....	223	848-120MM.....	234	84858.....	233	84938.....	235	858-215MM.....	239
8146.....	223	848-125MM.....	234	84859.....	233	84939.....	235	858-225MM.....	239
8148.....	223	848-130MM.....	234	84860.....	233	84940.....	235	858-235MM.....	239
8152.....	223	848-135MM.....	234	84861.....	233	84941.....	235	858-255MM.....	239
8154.....	223	848-140MM.....	234	84862.....	233	84942.....	235	858-60MM.....	239
8156.....	223	848-145MM.....	234	84863.....	233	84943.....	235	858-65MM.....	239
8158.....	223	848-150MM.....	234	84864.....	233	84944.....	235	858-70MM.....	239
8160.....	223	848-155MM.....	234	84865.....	233	84945.....	235	858-75MM.....	239
8162.....	223	848-41MM.....	234	84866.....	233	84946.....	235	858-80MM.....	239
8164.....	223	848-42MM.....	234	84867.....	233	84947.....	235	858-85MM.....	239
8166.....	223	848-43MM.....	234	84868.....	233	84948.....	235	858-90MM.....	239
8168.....	223	848-46MM.....	234	84869.....	233	84949.....	235	858-95MM.....	239
8170.....	223	848-47MM.....	234	84870.....	233	84950.....	235	858C18.....	237
8172.....	223	848-48MM.....	234	84871.....	233	84951.....	235	858C40.....	237
8174.....	223	848-50MM.....	234	84872.....	233	84952.....	235	8580.....	220
8176.....	223	848-52MM.....	234	84874.....	233	84953.....	235	85814.....	238
8178.....	223	848-55MM.....	234	84876.....	233	84954.....	235	85815.....	238
8180.....	223	848-56MM.....	234	84878.....	233	84955.....	235	85816.....	238
8182.....	223	848-60MM.....	234	84882.....	233	84956.....	235	85817.....	238
8184.....	223	848-65MM.....	234	84884.....	233	84957.....	235	85818.....	238
8188.....	223	848-70MM.....	234	84886.....	233	84958.....	235	85819.....	238
8190.....	223	848-75MM.....	234	84888.....	233	84959.....	235	85820A.....	238
8194.....	223	848-80MM.....	234	84896.....	233	84960.....	235	85821.....	238
8196.....	223	848-85MM.....	234	848104.....	233	84961.....	235	85822.....	238
8197.....	223	848-90MM.....	234	849-100MM.....	236	84962.....	235	85823.....	238
8198.....	223	848-95MM.....	234	849-105MM.....	236	84963.....	235	85824.....	238
8199.....	223	848C36.....	237	849-110MM.....	236	84964.....	235	85825.....	238
821.....	218	848C40.....	237	849-115MM.....	236	84965.....	235	85826.....	238
8220.....	231	848C44.....	237	849-120MM.....	236	84966.....	235	85827.....	238
8224.....	231	848C48.....	237	849-125MM.....	236	84967.....	235	85828.....	238
8228.....	231	848C56.....	237	849-130MM.....	236	84968.....	235	85829.....	238
8232.....	231	84800.....	231	849-41MM.....	236	84969.....	235	85830.....	238
8240.....	231	84822.....	233	849-42MM.....	236	84970.....	235	85831.....	238
829.....	218	84823.....	233	849-43MM.....	236	84971.....	235	85832.....	238
8400.....	219	84824.....	233	849-46MM.....	236	84972.....	235	85833.....	238
8402.....	219	84825.....	233	849-50MM.....	236	84974.....	235	85834.....	238
8408.....	219	84826.....	233	849-52MM.....	236	84976.....	235	85835.....	238
8417.....	219	84827.....	233	849-55MM.....	236	84980.....	235	85836.....	238
8425.....	219	84828.....	233	849-56MM.....	236	85576.....	235	85837.....	238
8435.....	220	84829.....	233	849-60MM.....	236	85577.....	235	85838.....	238
8440.....	220	84830.....	233	849-65MM.....	236	85578.....	235	85839.....	238
8441.....	220	84831.....	233	849-70MM.....	236	85579.....	235	85840.....	238
8443.....	220	84832.....	233	849-75MM.....	236	85580.....	235	85841.....	238
8444.....	218	84833.....	233	849-80MM.....	236	85581.....	235	85842.....	238
8447.....	247	84834.....	233	849-85MM.....	236	8576.....	204, 220	85843.....	238
8448.....	247	84835.....	233	849-90MM.....	236	8577.....	204, 220	85844.....	238
8449.....	247	84836.....	233	849-95MM.....	236	8578.....	204, 220	85845.....	238
84575.....	232	84837.....	233	84900.....	231	858-100MM.....	239	85846.....	238
84576.....	232	84838.....	233	84901.....	231	858-105MM.....	239	85849.....	238
84577.....	232	84839.....	233	84908.....	231	858-110MM.....	239	85852.....	238
84578.....	232	84840.....	233	84912.....	231	858-115MM.....	239	85854.....	238
8470.....	248	84841.....	233	84915.....	231	858-120MM.....	239	85855.....	238
8471.....	249	84842.....	233	84922.....	235	858-125MM.....	239	85861.....	238
8472.....	249	84843.....	233	84923.....	235	858-130MM.....	239	85864.....	238





Wright Tool Numerical Index

Wright Tool No.	Page No.	Wright Tool No.	Page No.	Wright Tool No.	Page No.	Wright Tool No.	Page No.	Wright Tool No.	Page No.
8724.....	223	8811.....	228	89-34MM.....	227	8982.....	227	9C369.....	291
8728.....	223	8811A.....	228	89-35MM.....	227	8986.....	227	9C369CB.....	288
8730.....	223	88116.....	224	89-36MM.....	227	8988.....	226	9C386.....	291
8732.....	223	8812.....	228	89-37MM.....	227	8990.....	226	9C410.....	290
8734.....	223	88120.....	224	89-38MM.....	227	8991.....	229	9C414.....	290
8736.....	223	88124.....	224	89-41MM.....	227	8992.....	226	9C420.....	290
8740.....	223	88128.....	224	89-42MM.....	227	8994.....	226	9C420CB.....	288
8742.....	223	8813.....	228	89-43MM.....	227	8996.....	226	9C421.....	290
8744.....	223	88132.....	224	89-46MM.....	227	89100.....	226	9C422.....	290
8746.....	223	88136.....	224	89-47MM.....	227	89104.....	226	9C424.....	290
8748.....	223	88144.....	224	89-50MM.....	227	89108.....	226	9C426.....	290
8752.....	223	8815.....	228	89-52MM.....	227	89112.....	226	9C428.....	290
8754.....	223	8816A.....	228	89-55MM.....	227	89116.....	226	9C430.....	290
8756.....	223	8817.....	228	89-56MM.....	227	29120.....	226	9C430CB.....	288
8760.....	223	8824.....	224	89-60MM.....	227	89124.....	226	9C436.....	292
8764.....	223	8826.....	224	89-65MM.....	227	89128.....	226	9C437.....	292
8766.....	223	8828.....	224	89-70MM.....	227	89132.....	226	9C440.....	290
8772.....	223	8830.....	224	89-75MM.....	227	89136.....	226	9C442.....	290
8776.....	223	8832.....	224	89-80MM.....	227	89144.....	226	9C447.....	292
88.....	49	8834.....	224	89-85MM.....	227	9A611.....	92	9C460.....	290
88-100MM.....	225	8836.....	224	89-90MM.....	227	9A613.....	92	9C480.....	290
88-110MM.....	225	8838.....	224	89-95MM.....	227	9A634.....	92	9C526.....	292
88-115MM.....	225	8840.....	224	8924R.....	228	9A635.....	92	9C537.....	292
88-19MM.....	225	8842.....	224	8928R.....	228	9A636.....	92	9C546.....	292
88-21MM.....	225	8844.....	224	8934R.....	228	9A637.....	92	9C548.....	292
88-22MM.....	225	8846.....	224	8936R.....	228	9A638.....	92	9C558.....	293
88-23MM.....	225	8848.....	224	8938R.....	228	9A649.....	92	9C718.....	291
88-24MM.....	225	8850.....	224	8942R.....	228	9A650.....	92	9C85.....	293
88-26MM.....	225	8852.....	224	8946R.....	228	9AB04.....	88	9C909.....	293
88-27MM.....	225	8854.....	224	8952R.....	228	9AB06.....	88	9C909CB.....	289
88-28MM.....	225	8856.....	224	8970R.....	228	9AB08.....	88	9C911.....	292
88-29MM.....	225	8858.....	224	89E24.....	221	9AB10.....	88	9C911CB.....	289
88-30MM.....	225	8860.....	224	8900.....	221	9AB12.....	88	9C938.....	286
88-32MM.....	225	8862.....	224	8902.....	221	9AB15.....	88	9C938-90.....	286
88-33MM.....	225	8864.....	224	8907.....	221	9AB18.....	88	9C947.....	286
88-34MM.....	225	8866.....	224	8910.....	221	9AB24.....	88	9C947-90.....	286
88-35MM.....	225	8868.....	224	8913.....	221	9AC04.....	88	9C970.....	286
88-36MM.....	225	8870.....	224	8924.....	226	9AC06.....	88	9C970-90.....	286
88-37MM.....	225	8872.....	224	8926.....	226	9AC08.....	88	9CGL10.....	290
88-38MM.....	225	8874.....	224	8928.....	226	9AC10.....	88	9CGL12.....	290
88-41MM.....	225	8876.....	224	8930.....	226	9AC12.....	88	9CGL6.....	290
88-42MM.....	225	8878.....	224	8932.....	226	9AC15.....	88	9CQT-6.....	286
88-43MM.....	225	8880.....	224	8933.....	226	9AC18.....	88	9E10007.....	282
88-46MM.....	225	8882.....	224	8934.....	227	9AC24.....	88	9E10113.....	273
88-47MM.....	225	8884.....	224	8936.....	226	9AC36.....	88	9E10118.....	273
88-48MM.....	225	8886.....	224	8938.....	226	9AD06.....	88	9310213.....	274
88-50MM.....	225	8888.....	224	8939.....	226	9AD08.....	88	9E10222.....	275
88-52MM.....	225	8890.....	224	8940.....	227	9AD10.....	88	9E10311.....	272
88-54MM.....	225	8892.....	224	8942.....	226	9AG04.....	88	9E10509.....	274
88-55MM.....	225	8893.....	229	8944.....	226	9AG06.....	88	9E10515.....	273
88-56MM.....	225	8894.....	224	8946.....	226	9AG08.....	88	9E10609.....	274
88-58MM.....	225	8896.....	224	8948.....	226	9AG10.....	88	9313213.....	280
88-60MM.....	225	8897.....	224	8950.....	226	9AG12.....	88	9E13609.....	281
88-65MM.....	225	8897A.....	224	8952.....	226	9C212.....	290	9E20511.....	276
88-70MM.....	225	8898.....	224	8954.....	226	9C215.....	290	9E20811.....	276
88-75MM.....	225	8899.....	224	8956.....	226	9C317.....	291	9E20911.....	276
88-80MM.....	225	89.....	54	8958.....	226	9C318.....	291	9E21151.....	275
88-85MM.....	225	89-100MM.....	227	8960.....	226	9C318CB.....	289	9E21171.....	275
88-87MM.....	229	89-105MM.....	227	8962.....	226	9C326.....	291	9E25172.....	277
88-90MM.....	225	89-110MM.....	227	8964.....	226	9C337.....	292	9E25581.....	277
88-91MM.....	229	89-115MM.....	227	8966.....	226	9C338.....	292	9E25611.....	277
88-95MM.....	225	89-23MM.....	227	8968.....	226	9C338CB.....	289	9E25911.....	278
8800.....	221	89-24MM.....	227	8970.....	226	9C347.....	291	9E25912.....	278
8807.....	228	89-27MM.....	227	8972.....	226	9C348.....	291	9E33198.....	280
8808.....	228	89-28MM.....	227	8974.....	226	9C349.....	291	9E35195.....	280
8809.....	228	89-30MM.....	227	8976.....	226	9C350S.....	291	9E60609.....	278
8810.....	228	89-32MM.....	227	8980.....	226	9C357.....	292	9E60614.....	279
8810A.....	228	89-33MM.....	227	8981.....	226	9C358CB.....	289	9E60811.....	281





Wright Tool Numerical Index

Wright Tool No.	Page No.	Wright Tool No.	Page No.	Wright Tool No.	Page No.	Wright Tool No.	Page No.	Wright Tool No.	Page No.
9E64608.....	281	9M720.....	314	9V6R.....	296	90412C.....	317	9143.....	264
9E64611.....	279	9M725.....	314	9V6SP.....	296	9042.....	302	9144.....	264
9E64808.....	274	9M740.....	312	9V7CR.....	295	9043.....	302	9145.....	264
9E69207.....	271	9M745.....	312	9V7LW.....	296	9044.....	302	9146.....	264
9E69209.....	271	9M750.....	312	9V7R.....	297	9044.....	302	915.....	63
9E69210.....	272	9P107D.....	294	9V7WR.....	295	9045.....	302	9151.....	264
9E69211.....	271	9P107S.....	294	9V8R.....	297	9047.....	304	9152.....	264
9E69218.....	272	9P127D.....	294	9V9LN.....	295	9048.....	304	9153.....	264
9G85101.....	326	9P6510L.....	294	9V9R.....	297	9049.....	304	9154.....	264
9G85102.....	326	9P6510R.....	294	90.....	49	905.....	62	9155.....	264
9G85103.....	326	9P6716B.....	293	9005.....	98, 329	9050.....	302	9156.....	264
9G85104.....	326	9P6716L.....	293	90102.....	318	9051.....	302	9157.....	264
9G85105.....	326	9P6716R.....	293	90102H.....	318	9052.....	303	9162.....	264
9G95202.....	326	9P6716S.....	293	90103.....	318	9053.....	303	9163.....	264
9H1221.....	286	9P77D.....	294	90103H.....	318	9054.....	303	9164.....	264
9H1221RK.....	286	9P77S.....	294	90104.....	318	9055.....	304	9165.....	264
9H1221S.....	285	9R31000.....	89	90104H.....	318	9056.....	304	9166.....	264
9H1234.....	285	9R31005.....	89	90105H.....	318	9057.....	304	9172.....	264
9H1234RK.....	286	9R31010.....	89	90106.....	318	9058.....	304	9173.....	264
9H1265K.....	286	9R31015.....	89	90106H.....	318	9059.....	304	9174.....	264
9H65.....	285	9R31020.....	89	90108.....	318	9060.....	304	9175.....	264
9H65RK.....	286	9R31025.....	89	90108H.....	318	9061.....	303	9176.....	264
9H87.....	285	9R31030.....	89	90110.....	318	9062.....	303	9177.....	264
9H8720.....	286	9R31035.....	89	90110H.....	318	9063.....	303	9180.....	265
9H8790.....	286	9R31040.....	89	90112.....	318	9064.....	303	9181.....	265
9L28100.....	249	9R31090.....	89	90112H.....	318	9065.....	301	9182.....	265
9M10204.....	313	9R31095.....	89	9013.....	318	9066.....	303	9183.....	265
9M10217.....	313	9R31100.....	89	9014.....	302	9067.....	303	9184.....	265
9M10221.....	313	9R31105.....	89	9015.....	302	9068.....	303	9185.....	265
9M25075.....	310	9R31110.....	89	9016.....	302	9069.....	303	9186.....	265
9M25076.....	310	9R31115.....	89	9017.....	302	907.....	62	9187.....	265
9M25077.....	310	9S290P.....	255	9020.....	321	9070.....	303	9203.....	116
9M40022.....	312	9S291.....	255	9021.....	301	9072.....	303	9210.....	266
9M40138.....	311	9S292.....	255	9022.....	301	9076.....	189	9212.....	266
9M40139.....	311	9S3900A.....	257	9023.....	301	9077.....	303	9214.....	266
9M40162.....	311	9S391.....	255	9024.....	301	9078.....	303	9216.....	266
9M40164.....	311	9S391RS.....	256	9025.....	301	9079.....	303	9218.....	266
9M41280.....	311	9S392B.....	255	9026.....	301	911.....	62	9220.....	268
9M41285.....	311	9S392RS.....	256	9028.....	301	9101.....	263	9221.....	268
9M42000.....	324	9S393A.....	255	9029.....	301	9103.....	263	9222.....	268
9M42001.....	324	9S393R5.....	256	9030.....	301	9104.....	263	9223.....	268
9M42002.....	324	9S394.....	256	9031.....	301	9105.....	263	9224.....	268
9M42003.....	324	9S394RS.....	256	9032.....	301	9106.....	263	9225.....	268
9M42004.....	324	9S395.....	256	9033.....	302	9107.....	263	9226.....	268
9M42005.....	324	9S395RS.....	256	9034.....	302	9108.....	263	9227.....	268
9M42006.....	324	9S492.....	256	9035.....	302	9109.....	263	9228.....	268
9M42007.....	324	9S7475.....	258	9036.....	302	9112.....	263	9229.....	268
9M424.....	311	9STM12.....	257	9037.....	302	9113.....	263	9230.....	268
9M426.....	311	9STM30.....	257	9038.....	302	9114.....	263	9236.....	268
9M428.....	311	9STM70.....	257	9039.....	173	9115.....	263	9237.....	268
9M45004.....	329	9UPSP4.....	324	9040.....	302	9116.....	263	9238.....	268
9M472.....	312	9V10CR.....	295	90402B.....	317	9117.....	263	9239.....	268
9M481.....	311	9V10LW.....	296	90402C.....	317	9118.....	263	9240.....	268
9M482.....	311	9V10R.....	296	90403B.....	317	9122.....	263	9241.....	268
9M483.....	311	9V10WR.....	295	90403C.....	317	9123.....	263	9242.....	268
9M484.....	311	9V11R.....	296	90404B.....	317	9124.....	263	9243.....	268
9M60000.....	324	9V11SP.....	296	90404C.....	317	9125.....	263	9244.....	268
9M60001.....	324	9V18R.....	296	90404E.....	317	9126.....	263	9245.....	268
9M60140.....	311	9V18SP.....	296	90406B.....	317	9127.....	263	9250.....	117, 322
9M60144.....	311	9V20R.....	297	90406C.....	317	9128.....	263	9251.....	117, 322
9M60146.....	311	9V24R.....	296	90406E.....	317	9132.....	263	9252.....	117, 322
9M61355.....	311	9V24SP.....	296	90408B.....	317	9133.....	263	9255.....	156, 322
9M61360.....	306	9V4LN.....	295	90408C.....	317	9134.....	263	9256.....	156, 322
9M62065.....	305	9V4LW.....	296	90408E.....	317	9135.....	263	9257.....	156, 322
9M705.....	311	9V4SP.....	296	9041.....	302	9136.....	263	9258.....	156, 322
9M710.....	311	9V4WR.....	295	90410B.....	317	9137.....	263	9271.....	117, 322
9M715.....	311	9V5WR.....	295	90410C.....	317	914.....	63	9272.....	117, 322
9M717.....	311	9V6LN.....	295	90412B.....	317	9141.....	264	9273.....	117, 322





Wright Tool Numerical Index

Wright Tool No.	Page No.	Wright Tool No.	Page No.	Wright Tool No.	Page No.	Wright Tool No.	Page No.	Wright Tool No.	Page No.
9274	117, 322	9465	287	9593	313	9682	307	D983	370
9275	117, 322	9466	287	9594	313	9683	308	D984	370
9276	117, 322	9467	287	9595	313	9684	308	D985	373
9277	117, 322	9468	287	9596	313	9685	313	D986	373
9280	117, 322	9470	287	9597	313	9690	314	D987	367
9281	156, 323	9471	287	9598	313	9691	314	S1198RACK	52
9282	156, 323	9472	287	9599	313	9692	314	S1202RACK	52
9283	156, 323	9473	287	96A	49	9693	314	S1203RACK	52
9284	156, 323	9475	261	9600	313	97	49	S1507RACK	52
9285	156	9476	261	9601	313	9700	330	S1510RACK	52
9286	156	9477	261	9602	313	9701	330	S1512RACK	52
9287	191, 323	9487	325	9603	313	9702	330	W008	51
9288	191, 323	9488	325	9604	313	9703	330	W010	51
9290	156, 322	9489	325	9605	313	98	49	W013	51
9291	191, 323	9491	325	9606	313	A707-POUCH	51	W108	51
9292	156, 322	9492	325	9607	313	A711-POUCH	51	W110	51
9295	155, 321	9493	328	9608	313	A714-POUCH	51	W113	51
9296	155, 321	950	63	9609	313	A724-POUCH	51	W2	51
9297	321	9500	171	9610	314	D938B	376	W3	51
9301	326	9501	171	9611	314	D938BRACKET	376	W316	49
9302	326	9505	328	9612	314	D938FOUR	376	W4	51
9304	326	9507	328	9613	314	D938HEAD	376	W408	49
9307	326	9508	328	9614	314	D938LEG	376	W409	49
9381	96	9509	328	9615	314	D938SIX	376	W411	49
9382	96	9510	328	9620	314	D938TRAY4SH	376	W416	49
9383	96	952	64	9621	314	D938TRAY4ST	376	W417	49
9383A	96	9521	329	9622	314	D938TRAY6ST	376	W418	49
9383B	96	9522	329	9623	314	D940	368	WT009	48
9384	96	9523	328	9624	314	D941B	367	WT3003	48
9385	96	9525	325	9625	314	D942	367	WT3010	48
9386	96	9526	325	9627	314	D943	368	WT3012	48
9387	96	9527	325	9629	72	D946	371	WT3014	48
9388	96	9528	327	9630	87	D947	371	WT3016	48
9389	96	9529	327	9631	87	D948	371	WT503	41
9390	96	9530	327	9632	87	D949	372	WT510	41
9396	97	9531	328	9633	87	D950	372	WT520	46
9397	97	9534	329	9634	87	D951	372	WT523	45
9413	91	9535	329	9636	87	D952	372	WT524	45
9414	91	9536	310	9637	87	D953	373	WT528	46
9416	95	9537	310	9638	87	D955B	367	WT710	38
9417	95	9538	310	9640	87	D956	368	WT796	38
9418	95	9539	310	9641	87	D957	370	WT798	39
9419	95	9540	310	9642	87	D958	371	WT803	43
9421	95	9552	310	9643	87	D959	374	WT804	40
9422	95	9553	310	9644	87	D960	374	WT805	42
9423	95	9555	310	9645	87	D961	369	WT814	40
9424	97	9556	310	9660	305	D962	375	WT816	39
9425	97	9557	310	9661	305	D963	375	WT834	44
9426	97	9558	310	9662	306	D965	376	WT854	37
9427	97	9560-ROLL	51	9663	306	D966	376	WT854R	36
9428	97	9563	311	9664	308	D967	376	WT854RB	36
9429	71	9564	311	9665	309	D968	376	WT854RBL	36
9430	71	9575	312	9666	309	D969	375	WT855	35
9431	96	9576	312	9667	310	D970	375	WT861	37
9432	96	9577	312	9668	310	D971	376	WT865	35
9434	96	9578	312	9669	310	D971HOOK	376	WT877	36
9435	96	958	64	9670	310	D972	369	WT877B	36
9436	96	9581	312	9671	310	D973	374	WT877BL	36
9437	96	9582	312	9672	310	D974	374	WT896	42
9438	96	9583	312	9673	310	D975	369	WT899	43
9439	71	9584	312	9674	310	D976	369	WT916B	47
9446	72	9585	312	9675	310	D977	367	WT933B	47
9460	90, 321	9586	312	9676	310	D978	367	WT952	34
9461	90, 321	9587	312	9677	310	D979	367	WT962	34
9462	262	9590	313	9678	310	D980	367		
9463	262	9591	313	9680	307	D981	368		
9464	262	9592	313	9681	307	D982	370		



Think Safety!

TOOL STORAGE UNIT (boxes, chests, cabinets)

- Users and bystanders must wear safety goggles.
- To avoid possible eye injury from flying objects, safety goggles or equivalent protection conforming to ANSI Z87.1 shall be worn and kept clean by the user and all persons in the immediate area where any tool is being used.
- Do not stand or climb on drawers.
- Do not open more than one drawer at a time.
- Never pull your tool storage unit. Always push so you can see the direction you are traveling and avoid obstacles. Move tool storage units in a controlled manner on smooth, level surfaces.
- Never use a tool storage unit for an anvil, workbench, ladder, or similar purpose.
- Do not stand on tool boxes, tool chests or tool cabinets.
- Do not overload drawers.
- Do not move a tool storage unit without locking or securing all drawers or lids.
- Never leave tools unattended on top of a tool storage unit.
- Make sure that wheels on tool storage units turn freely.
- Set the brakes on locking casters when the storage unit is at the work area.

WRENCHES

- Users and bystanders must wear safety goggles.
- To avoid possible eye injury from flying objects, safety goggles or equivalent protection conforming to ANSI Z87.1 shall be worn and kept clean by the user and all persons in the immediate area where any tool is being used.
- Comfort or plastic grips on handles are not intended to give any degree of protection against electric shock and shall not be used on or near live electric circuits.
- Wrenches are to be used by hand only. Do not use cheater bars or any other means of increasing leverage. The only wrenches that can be struck with a hammer are striking wrenches.
- Never use wrenches for prying or as a hammer.
- Never expose any wrench to excessive heat, which may change the hardness or microstructure and ruin the tool.
- Wrenches are to be used to turn (tighten and loosen) fasteners.
- Users shall apply a controlled force with a stance adjusted and braced to prevent rapid bodily movement or a fall if sudden release occurs.
- Use the correct size wrench, do not use metric wrenches on inch fasteners or inch wrenches on metric fasteners, because the fit is not good enough.
- Always be sure to fully seat an open-end wrench on the nut or bolt.
- Adjustable wrenches need to be tightly adjusted to fit the nut with the force applied to the fixed jaw. Never use adjustable wrenches for the initial breaking loose of a “frozen” fastener or for final tightening.

- Pipe wrenches are designed to turn or hold pipe; never use a pipe wrench to bend, raise or lift a pipe. Do not use pipe wrenches on square stock.
- Inspect each pipe wrench or adjustable wrench before use for worn or broken teeth, thumbscrews or jaws and discard if deteriorated.
- Inspect and discard bent, worn or cracked wrenches.
- Wrench opening configurations shall be inspected before each use and their use discontinued at the first sign of significant wrenching surface deterioration.
- Wrenches shall not be used when jaws are sprung to the point slippage may occur.

STRIKING WRENCHES

- Users and bystanders must wear safety goggles.
- To avoid possible eye injury from flying objects, safety goggles or equivalent protection conforming to ANSI Z87.1 shall be worn and kept clean by the user and all persons in the immediate area where any tool is being used.
- Striking wrenches are special-purpose tools designed and intended only for use with heavy-duty fasteners where shock or impact is needed to fully tighten or loosen.
- A striking tool shall always be used with the striking face parallel to the struck face of the wrench. Glancing blows, overstrikes and understrikes need to be avoided. No surface of the wrench other than the struck face shall be struck. The striking tool of the appropriate size shall have a striking face diameter not less than 3/8" larger than the struck face of the wrench.
- Users shall apply a controlled force with a stance adjusted and braced to prevent rapid bodily movement or a fall if sudden release occurs.
- Striking wrenches shall not be used with “cheater” pipes or other means to extend the length of the tool.
- Striking wrenches shall be inspected prior to each use and their use discontinued at the first sign of bending of the shank or chipping or cracking of the box end or struck block. Deformation of the wrenching configuration may occur from tool usage.
- Striking wrenches shall be inspected prior to each use and their use discontinued at the first sign of significant wrenching surface deterioration.
- At the first indication of mushrooming, the struck face and struck face chamfer of the striking wrench shall be redressed to its original contour by the use of a hand file or whetstone.
- Except the struck face, no area, section, or portion of the striking wrench shall be ground, welded, treated by reheating, or otherwise altered from the original condition as furnished by the manufacturer.
- Care shall be exercised to prevent the wrench from dislodging from the fastener or nut while being impacted.

HAND SOCKETS, HANDLES & ATTACHMENTS

- Users and bystanders must wear safety goggles.
- To avoid possible eye injury from flying objects, safety goggles or



Continued on page 400



Continued from page 399

equivalent protection conforming to ANSI Z87.1 shall be worn and kept clean by the user and all persons in the immediate area where any tool is being used.

- Comfort or plastic grips on handles are not intended to give any degree of protection against electric shock and shall not be used on or near live electric circuits.
- Never use hand sockets or hand attachments on power drivers, impact drivers or hydraulic drivers. Black industrial sockets, torx sockets and torx bit sockets are designed and finished to be hand sockets – not impact.
- Never use cheater bars to increase handle leverage.
- Never hammer on a ratchet or handle.
- Never use ratchets or other handles as a hammer or pry bar.
- Hand sockets are to be attached to ratchets and handles and used by hand to turn fasteners.
- Users shall apply a controlled force with a stance adjusted and braced to prevent rapid bodily movement or a fall if sudden release occurs.
- Use the correct size socket, do not use metric sockets on inch fasteners or inch sockets on metric fasteners, because the fit is not good enough. Do not use hex sockets on square fasteners or square sockets on hex fasteners.
- Place the socket all the way on the fastener.
- Adaptor strength is limited to the smallest drive square member.
- Never use sockets as a driver for hex or square bits or shafts.
- Inspect and discard bent, worn or cracked sockets, handles or attachments.
- Socket opening configurations shall be inspected before each use and their use discontinued at the first sign of significant wrenching surface deterioration.

IMPACT SOCKETS

- Users and bystanders must wear safety goggles.
- To avoid possible eye injury from flying objects, safety goggles or equivalent protection conforming to ANSI Z87.1 shall be worn and kept clean by the user and all persons in the immediate area where any tool is being used.
- Do not hold impact sockets, universal joints or extensions while an impact tool is running. Serious hand injury can occur.
- 3/4" drive and larger drive size impact sockets require the use of a ret ring or a Pin & O-ring to secure the socket to the driving square.
- Never use a nail or homemade pin for holding a socket in place.
- Never exceed the manufacturer's gun pressure rating.
- Impact sockets are to be used to turn (tighten or loosen) fasteners while being driven by a power, impact or hydraulic driver.
- Never dwell on a socket after it has stopped running. This can damage both the socket and the fastener.
- Place the socket all the way on the fastener before starting the gun.
- Adaptor strength is limited to the smallest drive square member.

- Mind the joints between the gun and fasteners for less loss of torque and less wear.
- Use the correct size socket, do not use metric sockets on inch fasteners or inch sockets on metric fasteners, because the fit is not good enough. Do not use hex sockets on square fasteners or square sockets on hex fasteners.
- Never use sockets as a driver for hex or square bits or shafts.
- Large drive impact sockets are inherently heavy and care needs to be taken during handling.
- Socket opening configurations shall be inspected before each use and their use discontinued at the first sign of significant wrenching surface deterioration.
- Inspect and discard worn or cracked sockets.

TORQUE WRENCHES

- Users and bystanders must wear safety goggles.
- To avoid possible eye injury from flying objects, safety goggles or equivalent protection conforming to ANSI Z87.1 shall be worn and kept clean by the user and all persons in the immediate area where any tool is being used.
- Comfort or plastic grips on handles are not intended to give any degree of protection against electric shock and shall not be used on or near live electric circuits.
- Torque wrenches are a precision instrument. Read the instruction manual completely before using any torque wrench and learn the proper method to operate, maintain and store torque wrenches.
- Torque wrenches are to be used to tighten fasteners only. Do not use torque wrenches to loosen or remove fasteners.
- Users shall apply a controlled force with a stance adjusted and braced to prevent rapid bodily movement or a fall if sudden release occurs.
- Always pull, do not push to apply torque.
- Do not use torque wrenches with sockets or fasteners showing wear or cracks.
- Keep torque wrenches clean. The ratchet mechanism may slip or break if dirty, mismatched or worn parts are used.
- Make sure the direction lever is fully engaged.
- Take care to never overload a torque wrench past its maximum torque capacity.
- Torque wrenches are to be used by hand only. Do not use cheater bars or any other means of increasing leverage.
- Use the appropriate drive size. Select the torque wrench drive that is in the mid-range of the desired torque.
- Never expose any torque wrench to excessive heat, which may change the hardness or microstructure and ruin the tool.
- Never use torque wrenches for prying or as a hammer.
- Send torque wrenches to a qualified lab for calibration at least once a year or every 5,000 cycles, whichever comes first.
- Inspect and discard bent, worn or damaged torque wrenches.

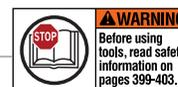

TORQUE MULTIPLIERS

- Users and bystanders must wear safety goggles.
- To avoid possible eye injury from flying objects, safety goggles or equivalent protection conforming to ANSI Z87.1 shall be worn and kept clean by the user and all persons in the immediate area where any tool is being used.
- A torque multiplier generates an output torque much greater than the input torque. Do not use a torque multiplier without reading and learning the safety and operating instructions that are provided with each torque multiplier.
- Users must wear hard hats, gloves and steel toed boots.
- Users shall apply a controlled force with a stance adjusted and braced to prevent rapid bodily movement or a fall if sudden release occurs.
- Only use impact sockets with torque multipliers and secure to the output square with a retaining pin & O-ring. Never use hand sockets or any attachments (including adaptors) with torque multipliers.
- Before each use, inspect and replace any torque multiplier output squares showing signs of wear or cracks.
- Before each use, inspect and tighten the torque multiplier holding screws.
- Before each use, inspect and replace any impact sockets or fasteners showing signs of wear or cracks.
- Do not use impact guns with torque multipliers.
- Do not use breaker bars with torque multipliers.

SCREWDRIVERS AND NUTDRIVERS

- Users and bystanders must wear safety goggles.
- To avoid possible eye injury from flying objects, safety goggles or equivalent protection conforming to ANSI Z87.1 shall be worn and kept clean by the user and all persons in the immediate area where any tool is being used.
- Comfort or plastic grips on handles are not intended to give any degree of protection against electric shock and screwdrivers and nutdrivers shall not be used on or near live electric circuits.
- Users shall apply a controlled force with a stance adjusted and braced to prevent rapid bodily movement or a fall if sudden release occurs. Minimize pressure. Screws are driven by torque (turning power), not pressure.
- Match the type of screwdriver to the head of the screw and select the appropriate size screwdriver to do the job.
- Never sharpen or alter a screwdriver to change the fit.
- Use the correct size nutdriver to fit the fastener. Do not use inch nutdrivers on metric fasteners or metric nutdrivers on inch fasteners because the fit is not good enough.
- Never use a screwdriver or nutdriver for prying, punching, chiseling, scoring or scraping.
- Never hammer on screwdrivers or nutdrivers and never use a screwdriver or a nutdriver as a hammer.
- Never use cheater bars to increase handle leverage.

- Never expose any screwdriver or nutdriver to excessive heat, which may change the hardness or microstructure and ruin the tool.
- Never use pliers on the handle of a screwdriver or nutdriver to get extra turning power. A wrench can be used on the square shank or bolster of screwdrivers designed for that purpose.
- Keep handles clean for a secure grip.
- Inspect and discard bent, worn, cracked, or damaged screwdrivers or nutdrivers. Do not grind or attempt to repair screwdrivers.

HEX KEYS

- Users and bystanders must wear safety goggles.
- To avoid possible eye injury from flying objects, safety goggles or equivalent protection conforming to ANSI Z87.1 shall be worn and kept clean by the user and all persons in the immediate area where any tool is being used.
- Comfort or plastic grips on handles are not intended to give any degree of protection against electric shock and shall not be used on or near live electric circuits.
- Users shall apply a controlled force with a stance adjusted and braced to prevent rapid bodily movement or a fall if sudden release occurs.
- Never hammer on a hex key.
- Never use a pipe or cheater bar on the handle or key end.
- Do not repair hex key wrenches.
- Inspect and discard bent, deformed or cracked hex key tools.

PLIERS

- Users and bystanders must wear safety goggles.
- To avoid possible eye injury from flying objects, safety goggles or equivalent protection conforming to ANSI Z87.1 shall be worn and kept clean by the user and all persons in the immediate area where any tool is being used.
- Comfort or plastic grips on handles are not intended to give any degree of protection against electric shock and pliers shall not be used on or near live electric circuits.
- Users shall apply a controlled force with a stance adjusted and braced to prevent rapid bodily movement or a fall if sudden release occurs.
- Choose the right plier for the job.
- Pliers shall not be used for cutting hardened wire unless specifically designed for this purpose.
- When cutting wire, always cut at right angles. Never rock from side to side or bend the wire back and forth against the cutting edges.
- Don't bend stiff wire with light pliers. Select the proper size plier.
- Pliers shall not be used on nuts or bolts. A wrench will do the job better and with less risk of damage to the fastener.
- Oil pliers occasionally at the joint only. Take care to keep the handles clean for a secure grip.
- Never use a plier for prying, punching, chiseling, scoring or scraping.
- Never hammer on pliers and never use a plier as a hammer.

Continued on page 402





Continued from page 401

- Never use cheater bars to increase leverage.
- Never expose any plier to excessive heat, which may change the hardness or microstructure and ruin the tool.
- Never use pliers on the handle of a screwdriver or nutdriver to get extra turning power.
- Inspect and discard bent, worn, cracked or damaged pliers. Do not grind or attempt to repair pliers.

SHEARS & SNIPS

- Users and bystanders must wear safety goggles.
- To avoid possible eye injury from flying objects, safety goggles or equivalent protection conforming to ANSI Z87.1 shall be worn and kept clean by the user and all persons in the immediate area where any tool is being used.
- Comfort or plastic grips on handles are not intended to give any degree of protection against electric shock and shall not be used on or near live electric circuits.
- Follow the manufacturer's instructions for use, capacity, and proper care of the snip.
- Be careful of the sharp cutting edges on the cutting blades. Keep blades closed when snip is not in use. Use safety latch to keep blades closed on available models.
- Be careful of the sharp edges of the material being cut when snips are used. Always wear gloves when working with snips.
- Never use a snip to cut sheet metal thicker than 1/16" (.062").
- Never use snips to cut heavy wire, cable, nails, rod, as these materials may damage the cutting edge or the shearing action of the snip.
- Use the right size and style of snip for the job. Do not cut tight curves with a straight pattern snip. Use offset models for long cuts through large sheets of material.
- Avoid springing the blades. This is the result of trying to cut material that is too thick.
- Use only hand pressure for cutting. Never hammer, use cheater bars or use feet to try and increase pressure.
- Do not attempt to re-sharpen a snip blade in a sharpening device designed for knives, scissors, or garden tools.

HAMMERS

- Users and bystanders must wear safety goggles.
- To avoid possible eye injury from flying objects, safety goggles or equivalent protection conforming to ANSI Z87.1 shall be worn and kept clean by the user and all persons in the immediate area where any tool is being used.
- Comfort or plastic grips on handles are not intended to give any degree of protection against electric shock and shall not be used on or near live electric circuits.
- Hammer heads shall be inspected prior to each use and the hammer discarded if it shows chipping, dents, cracks, mushrooming or excessive wear.

- Inspect handles before each use. Never use a hammer with a loose or damaged handle.
- Hammer blows must be struck squarely to the surface being struck.
- Avoid glancing blows.
- When striking another tool (punch, chisel, wedge, etc.), the striking face of the proper hammer must have a diameter at least 3/8" larger than the face of the struck tool.
- Keep striking faces free of oil and grease.
- Never use one hammer to strike another hammer.
- Never strike with the side (cheek) of a hammer.
- Nail hammers are intended to drive or pull unhardened nails only.
- Never strike hardened objects with a nail hammer.
- Never use a soft face hammer to drive a nail or any hardened object.
- Use dead blow hammers to minimize vibration.
- Instructors and employers shall train users and stress proper lifting and swinging techniques for each striking tool application.
- No area, section, or portion of a hammer shall be ground, welded, reheated, or otherwise altered from its original shape.

PUNCHES, CHISELS, PRY BARS

- Users and bystanders must wear safety goggles.
- To avoid possible eye injury from flying objects, safety goggles or equivalent protection conforming to ANSI Z87.1 shall be worn and kept clean by the user and all persons in the immediate area where any tool is being used.
- Comfort or plastic grips on handles are not intended to give any degree of protection against electric shock and shall not be used on or near live electric circuits.
- Metal cutting chisels are special purpose tools designed and intended for the cutting, shaping, and removal of metal softer than the cutting edge of the chisel. To avoid possible bodily injury, chisels must not be used on objects as hard as or harder than the chisel cutting edge. Do not use chisels on stone or concrete.
- When using chisels, the cutting edge must be pointed away from the user and any bystanders. Keep hands away from the cutting edge.
- Chisels and punches must not be used for prying or wedging, and no surface of the punch or chisel can be struck other than the struck face.
- When striking a punch or chisel, the striking face of the proper hammer must have a diameter at least 3/8" larger than the struck face of the chisel or punch. A hammer blow must be struck squarely with the hammer face parallel with the struck face of the chisel or punch. Avoid glancing blows.
- Chisels, punches, and pry bars shall be inspected before each use and their use discontinued at the first sign of excessive wear, chipping, cracking, bending or mushrooming of any surfaces.
- Never use a chisel or punch with a mushroomed struck face, a bent stem, or a chipped, dull or deformed cutting edge or point.
- Never hammer a pry bar or use a pry bar as a hammer.



- No area, section, or portion of a chisel, punch, or pry bar shall be ground, welded, reheated, or otherwise altered from its original shape.
- Users shall apply a controlled force with a stance adjusted and braced to prevent rapid bodily movement or a fall if sudden release occurs. Users need to take extra care when using pry bars to avoid bar slippage. Users must also avoid bodily strain when using pry bars.
- The point end diameter of the starter punch or pin punch must approximate the size of the work piece.
- Pin punches must not be used as a starting (solid) punch.
- Drift or lining punches are special purpose tools intended for aligning and sizing holes and must not be used for driving metal or other hard objects.

C-CLAMPS

- Users and bystanders must wear safety goggles.
- To avoid possible eye injury from flying objects, safety goggles or equivalent protection conforming to ANSI Z87.1 shall be worn and kept clean by the user and all persons in the immediate area where any tool is being used.
- Select C-clamps of proper size and capacity to handle the job.
- Always inspect clamps before using. Never use a C-clamp with:
 - Bent, twisted or cracked frame
 - Badly worn threads on spindle
 - Bent or cracked spindle
 - Swivel pads badly worn, not turning freely, or missing from spindle
- Never use a hammer or pipe extension to tighten a C-clamp; only tighten to prevent slippage. If a wrench is used on a C-clamp, do not exceed the recommended "nominal clamping pressure."
- Never use a C-clamp as a permanent holding device; always use a clamp only as a temporary holding tool.
- Never use a C-clamp to secure loads on moving vehicles.
- Never use a C-clamp with chain, strap, cable or hook to lift or move a load or work object.
- Never use a C-clamp to hoist or support any scaffolding.
- Never use a C-clamp as a safety eye hold.
- Never weld any parts of a C-clamp to other metal objects.
- Store C-clamps by clamping them in a rack, not in a drawer.

MISCELLANEOUS TOOLS & ACCESSORIES

- Users and bystanders must wear safety goggles.
- To avoid possible eye injury from flying objects, safety goggles or equivalent protection conforming to ANSI Z87.1 shall be worn and kept clean by the user and all persons in the immediate area where any tool is being used.
- Comfort or plastic grips on handles are not intended to give any degree of protection against electric shock and shall not be used on or near live electric circuits.

- Users shall apply a controlled force with a stance adjusted and braced to prevent rapid bodily movement or a fall if sudden release occurs.
- Never hammer or pry with scrapers, utility knives or extractors. Never use scrapers or utility knives as screwdrivers.
- Keep blades of utility knives and razor scrapers retracted in the housing except during use. Do not use dull blades. Keep free hand away from cutting edge.
- Hacksaw blades shall be taut. Do not use dull saw blades. Keep free hand away from the saw blade when sawing.
- No area, section or portion of hacksaws, utility knives, scrapers or extractors shall be ground, welded, heated or altered from their original condition.
- Prior to each use, hacksaws, utility knives, scrapers and extractors shall be inspected and their use discontinued at the first sign of bending or wear.
- Do not open tape measure cases. The tape is under spring tension.
- Control the retraction of the measuring tape to prevent injury to hands or other bodily parts.





WRIGHT TOOL COMPANY Pending & Granted Utility & Design Patents

List updated October, 2008

Country	Title	Patent No.
United States	WRENCH (Wright Grip)	6,907,805
United States	WRENCH (Wright Grip)	7,340,982
United States	WRENCH (Wright Grip)	D476,868
United States	WRENCH (Lg. Flat Stem Wrenches)	D451,352
United States	ASYMMETRIC WRENCH AND FASTENER SYSTEM (Wright Spline)	6,904,833
Europe	HIGH TORQUE WRENCHING SYSTEM (Wright Spline)	1071543
United States	HIGH TORQUE WRENCHING SYSTEM	6,698,315
United States	ASYMMETRICAL FASTENING SYSTEM	6,698,316
United States	HIGH TORQUE WRENCHING SYSTEM	6,725,746
United States	SOCKET WRENCH OPENING	4,882,957
United States	SOCKET WRENCH OPENING	5,284,073

WRIGHT TOOL COMPANY Docketed, Pending & Registered Trademarks

List updated October, 2008

Country	Trademark	TM Reg.	International Class(es)
United States	ROAD WARRIOR	2,840,694	6
Canada	WRIGHT SPLINE	TMA596,445	NA
Chile	WRIGHT SPLINE	643,564	8
European Community	WRIGHT SPLINE	002626356	8
Japan	WRIGHT SPLINE	4610955	8
Mexico	WRIGHT SPLINE		8
United States	WRIGHT SPLINE	2,694,067	8
China	WRIGHT GRIP	3456495	8
European Community	WRIGHT GRIP	003030434	8
United States	WRIGHTGRIP	2,826,114	8
China	WRIGHT GRIP (& DESIGN)	3456494	8
European Community	WRIGHT GRIP (& DESIGN)	003031499	8
United States	WRIGHTGRIP (& DESIGN)	2,826,148	8
European Community	WRIGHT TOOL	002892495	6, 8, 20
United States	COUGAR	2,215,089	8
United States	WRIGHTSOURCE	2,294,649	40
Japan	HARD WRIGHT DRIVE	4413910	6, 8
Japan	HARD DRIVE	4414163	8
Argentina	WRIGHT	2.110.237	8
Brazil	WRIGHT	827.429.061	8
Chile	WRIGHT	747.777	8
Colombia	WRIGHT	310.595	8
Dominican Republic	WRIGHT	157373	8
Mexico	WRIGHT	913855	8
United States	WRIGHT	1,022,945	8
Argentina	W (& DESIGN)	2.119.329	8
Brazil	W (& DESIGN)		8
Chile	W (& DESIGN)	747.776	8
Colombia	W (& DESIGN)	311729	8
Mexico	W (& DESIGN)		8
United States	W (& DESIGN)	1,272,436	8
United States	WRIGHT TOOL (& DESIGN)	1,272,435	8
United States	WRIGHT TOOL	1,372,182	8
France	WRIGHT DRIVE	1524168	8
Japan	WRIGHT DRIVE	2376918	8, 20
United States	WRIGHT DRIVE	1,551,474	8
United States	WRIGHT DRIVE	2,194,560	8





WRIGHT TOOL

PERFECTING PERFORMANCE™



WrightGrip™

WrightAlloy™

Wright Drive™

WrightSource™

Wright Spline™

Cougar™

The Leader in Heavy-Duty Hand Tools for Industry



WRIGHT TOOL

PERFECTING PERFORMANCE™

One Wright Dr., PO Box 512 • Barberton, OH 44203 USA • US and Canada: 800.321.2902 or 330.848.0600
Toll Free FAX: 800.543.2095 or 330.848.0602 • www.wrighttool.com

Made In U.S.A.