



Compact Fluorescent
Trim

8" Open Pro- Optic Alzak
2 Horizontal Triple Lamps
Non-IC

Recessed

Type _____

-21A -22A
P8115

Catalog No.	Finish		Dimensions (Inches)	
	Clear Alzak	Gold Alzak	A	B
P8115	-21A	-22A	9	7-3/4

Maximum Ceiling Thickness = 1-1/4

Ceiling Opening = 8-1/4

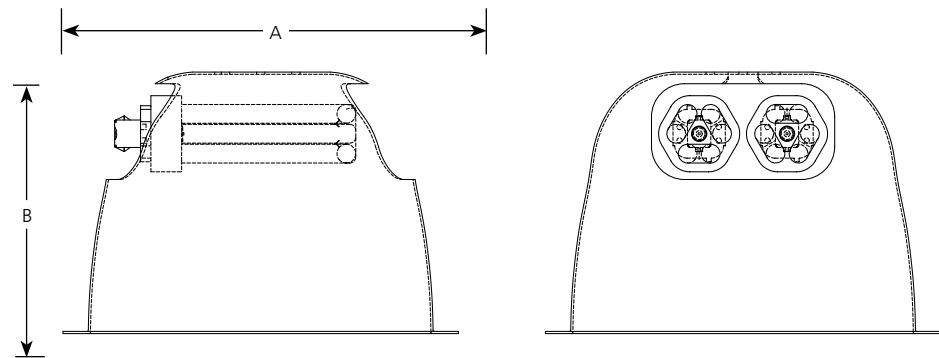

Lamp Wattage

Housing	IC	Non-IC
P8232-EB	N/A	1-26, 32 or 42w Triple tube

Specifications:

Flange

- White painted metal flange

Reflector

- All aluminum construction
- One piece construction with integral flange
- Alzak finish
- No light leaks around trim flange
- Socket box mounts to reflector for optimum performance and consistent lamp position
- Reflector retention accomplished by 3 spring clips located in aperture of housing
- Single reflector accommodates both standard and internal emergency housings

Labeling

- UL and CUL listed for damp location
- Non-IC rated

Progress Lighting
701 Millennium Blvd.
Greenville, South Carolina
29607

www.progresslighting.com

Rev. 9/08

P8232-EB/P8115-21A

8" DOWNLIGHT Specular Clear Anodized Aluminum

Report No. 2324-PROG

No. Lamps: 2 Type Lamp: 2 - CF32DT/E/IN SYLVANIA Total Lumens: 4800

Fixture Efficiency: 63.2%

S/MH Ratio: 1.5 (0°) 1.3 (90°)

Single Fixture Data

Ceiling Ht.(Ft.)	10% Values		Zero Degrees Ft.-C	50% Values	
	Beam Angle - 105°			Beam Angle - 71°	
	Ft.-C	Beam Dia.		Ft.-C	Beam Dia.
8	4.1	14	41.0	20.5	8
10	2.2	20	22.0	11.0	11
12	1.4	25	13.7	6.9	14
14	0.9	30	9.4	4.7	16
16	0.7	35	6.8	3.4	19

Ft.-C (Footcandles) are initial and measured 2'-6" from floor

Quick Calculator Charts

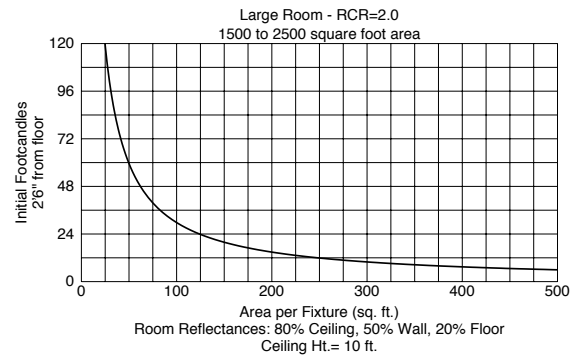
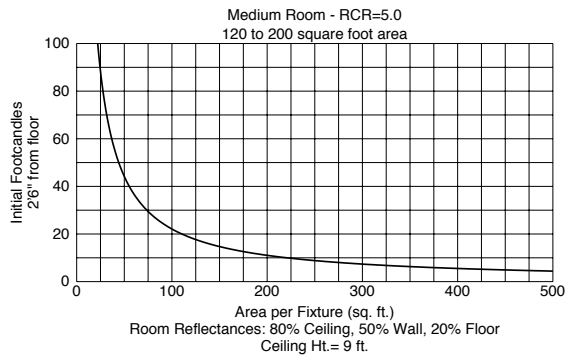

DISTRIBUTION CURVE

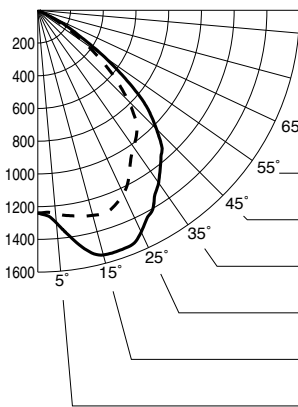

INTENSITY DATA

DEGREES	CANDELA	
	AT 0°	AT 90°
90	0	0
85	1	1
80	3	2
75	5	4
70	8	8
65	28	26
60	243	165
55	499	358
50	807	575
45	1025	781
40	1171	943
35	1287	1021
30	1405	1123
25	1495	1238
20	1549	1297
15	1548	1297
10	1455	1276
5	1305	1247
0	1239	1239

ZONAL CAVITY COEFFICIENTS OF UTILIZATION

Effective Floor Cavity Reflectance 0.20

RC	Effective Floor Cavity Reflectance 0.20																	
	80			70			50			30			10			0		
RW	70	50	30	10	70	50	30	10	50	30	10	50	30	10	50	30	10	0
0	75	75	75	75	74	74	74	74	70	70	70	67	67	67	65	65	65	63
1	71	69	67	65	69	67	65	64	65	63	62	62	61	60	60	59	58	57
2	66	62	58	56	64	61	58	55	59	56	54	57	54	53	55	53	51	50
3	61	56	52	48	60	55	51	48	53	50	47	51	49	46	50	48	46	44
4	57	50	46	42	55	50	45	42	48	44	41	47	43	41	45	43	40	39
5	52	46	41	37	51	45	40	37	44	40	37	42	39	36	41	38	36	35
6	49	41	37	33	48	41	36	33	40	36	33	39	35	32	38	35	32	31
7	45	38	33	29	44	37	33	29	36	32	29	36	32	29	35	31	29	28
8	42	35	30	27	41	34	30	26	33	29	26	33	29	26	32	29	26	25
9	40	32	27	24	39	32	27	24	31	27	24	30	26	24	30	26	24	23
10	37	30	25	22	36	29	25	22	29	25	22	28	24	22	28	24	22	21

P8232-EB/P8115-21A

8" DOWNLIGHT Specular Clear Anodized Aluminum

Report No. 2344-PROG

No. Lamps: 2 Type Lamp: 2 - CF42DT/E/IN SYLVANIA Total Lumens: 6400

Fixture Efficiency: 63.6%

S/MH Ratio: 1.5 (0°) 1.4 (90°)

Single Fixture Data

Ceiling Ht.(Ft.)	10% Values		Zero Degrees	50% Values	
	Beam Angle - 110°			Beam Angle - 72°	
	Ft.-C	Beam Dia.		Ft.-C	Beam Dia.
8	4.9	16	49.3	24.7	8
10	2.7	21	26.5	13.3	11
12	1.7	27	16.5	8.3	14
14	1.1	33	11.3	5.6	17
16	0.8	39	8.2	4.1	19

Ft.-C (Footcandles) are initial and measured 2'-6" from floor

Quick Calculator Charts

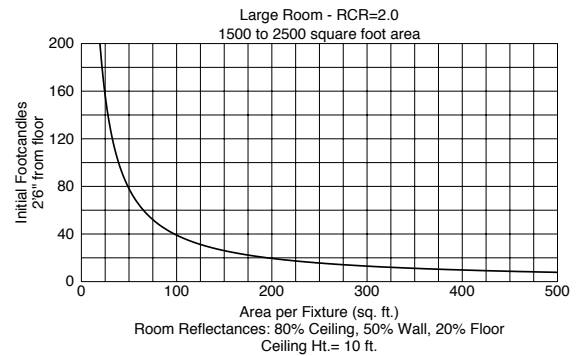
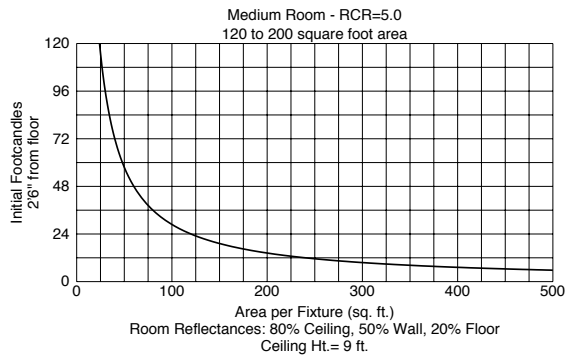

DISTRIBUTION CURVE

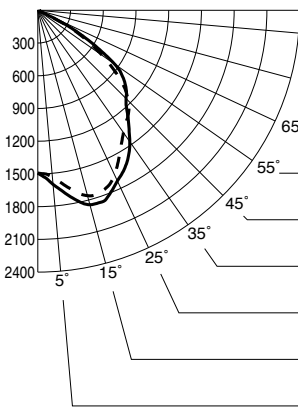

INTENSITY DATA

DEGREES	CANDELA	
	AT 0°	AT 90°
90	0	0
85	1	2
80	4	5
75	8	9
70	17	16
65	66	75
60	496	449
55	862	724
50	1044	988
45	1144	1172
40	1287	1281
35	1471	1369
30	1625	1506
25	1726	1664
20	1840	1756
15	1845	1759
10	1736	1655
5	1602	1537
0	1492	1492

ZONAL CAVITY COEFFICIENTS OF UTILIZATION

Effective Floor Cavity Reflectance 0.20

RC	Effective Floor Cavity Reflectance 0.20																	
	80			70			50			30			10			0		
RW	70	50	30	10	70	50	30	10	50	30	10	50	30	10	50	30	10	0
0	76	76	76	76	74	74	74	74	71	71	71	68	68	68	65	65	65	64
1	71	69	67	65	69	67	65	64	65	63	62	62	61	60	60	59	58	57
2	66	61	58	55	64	60	57	54	58	55	53	56	54	52	54	52	51	50
3	61	55	51	47	59	54	50	47	52	49	46	51	48	45	49	47	45	43
4	56	49	45	41	55	49	44	41	47	43	40	46	42	40	44	42	39	38
5	52	45	40	36	51	44	39	36	43	38	35	41	38	35	40	37	35	33
6	48	40	35	32	47	40	35	31	39	34	31	38	34	31	37	33	31	29
7	45	37	32	28	44	36	31	28	35	31	28	34	31	28	34	30	27	26
8	42	34	29	25	41	33	28	25	32	28	25	32	28	25	31	27	25	24
9	39	31	26	23	38	31	26	23	30	26	23	29	25	22	29	25	22	21
10	36	28	24	21	36	28	24	21	28	23	20	27	23	20	26	23	20	19