

Type _____
-30TG
P6414

Catalog No.	Finish White	Lamping	Dimensions (Inches)			
			A	B	C	D
P6414	-30TG	1 (m) 100w	8	14-1/4	4-1/4	9-1/2
			Ceiling opening 8-1/8			

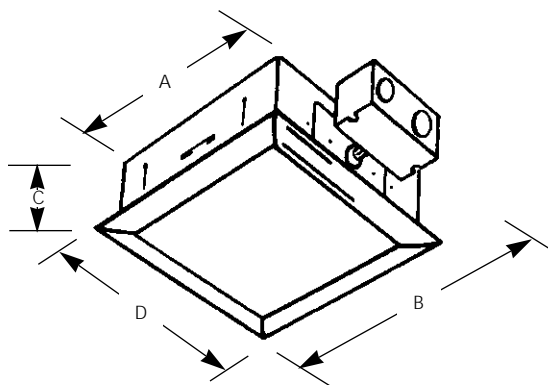

Specifications:

Wiring

- Universal junction box with snap out sides
- Grounding pigtail
- 1/2" & 3/4" knock outs for rigid or BX fittings

Construction

- Steel construction throughout
- Maximum ceiling thickness is 1"
- Four clips furnished for ceiling installation
- Outlet box assembly removable from inside unit for electrical inspection

Bar Hangers

- Must be ordered separately (P8716-01)
- 26" bar hangers span 24" T-bar spacing

Electrical

- Medium based porcelain socket with nickel plated brass screw shell
- Socket mounted in fixed position
- Pre-wired

Labeling

- Non-IC rated
- UL listed for damp locations

Trim

- Steel construction, painted white
- Flat white glass
- Trim installs with torsion springs and fits tight to ceiling