

Since 1911

Kennedy®

USA MADE CHESTS AND CABINETS



AMERICA'S PREMIER INDUSTRIAL TOOL STORAGE



Proudly Serving America Since 1911

100 years, that's how long Kennedy has been building the industry's most dependable tool storage units. It was in 1909, that Howard Kennedy, an engineer with the Pennsylvania Railroad, became an innovator born from need. Due to the rigors of the railroad, the standard fabric cloth tool holders were not protecting his gear. From his garage in Fort Wayne, Indiana, Howard designed and built a metal suitcase for himself, which was then being requested by the other engineers who worked for the rail lines. Howard's brother Charles, at that time an advertising executive with J. Walter Thompson Company in Chicago, noticed the value in Howard's creation of suitcases. It was at that time that the brothers began discussing the business potential for Howard's new all metal suitcase.

It was in 1911 that Kennedy Manufacturing Company was formally established, with Charles acting as its Secretary/Treasurer and General Manager, while Howard ran the factory in Fort Wayne, IN. Together, they designed and manufactured the first metal mechanics box and metal tackle box for Kennedy. In 1914, at the urging of a group of local businessmen from Van Wert, Ohio, the factory was relocated from Howard's garage in Fort Wayne, to a building, ironically located beside the Pennsylvania Rail Road tracks in Van Wert. From this move, a vision was formed, concentrated on improving the mechanics chest and tackle boxes and designing a variety of different metal products; lunch boxes, electricians kits, machinists chests, car luggage carrier, utility shelves, roller dolly and roller cabinets.

What started as a need for durability evolved into 100 years of commitment to building the highest quality American made products possible. During the past 100 years, our products have stood beside the American worker through the great depression, several recessions, prohibition, two world wars, a missile crisis, lunar landings, the building of a wall, the fall of the wall, September 11th, and the first and last shuttle launch. In that time, our commitment to our customers, community and employees has never wavered.

We take great pride in the fact that Kennedy branded products are still to this day being manufactured in Van Wert, Ohio, with many second and third generation craftsman.

We recognize that without your loyalty to the Kennedy product line, we would not be celebrating this tremendous milestone. We thank you for choosing to purchase our product and strive to continue to provide you, our customer, with finest quality tool storage solutions at competitive prices.

QUALITY

Design, construction and fabrication methods with functionality and ease of use.

SECURITY

High-security locks and internal locking mechanism.

FLEXIBILITY

Modular and interchangeable drawers and slides for re-configurations.

DURABILITY

Long life and endurance in harsh environments and work abuse.

TABLE OF CONTENTS

ABOUT KENNEDY.....	1
ONLINE CONFIGURATOR SYSTEM	2
BENCHMARK® SERIES.....	3-5
MAINTENANCE PRO™ SERIES.....	6-9
INDUSTRIAL SERIES	10-14
PRO-LINE™ SERIES MAINTENANCE CARTS.....	15-16
MECHANICS' & MACHINISTS' CHESTS	17-19
HAND CARRY TOOL BOXES.....	20
VERSA-BENCHES®	21-23
HEAVY-DUTY WORK STATIONS.....	24
STEEL TOOLBOARD SYSTEMS.....	25-29
STAINLESS STEEL ROLLER CABINETS	30
MODULAR CABINETS.....	31-38
MODULAR WORK STATIONS.....	39
HMS™ SERIES MODULAR CABINETS.....	40
MOBILE MODULAR CABINETS.....	41
MODULAR CABINET ACCESSORIES.....	42-43
NC/CNC PRODUCTS	44-45
INDEX.....	46



THE KENNEDY CONFIGURATOR

Design and Build Your Custom Kennedy Modular Cabinet

Visit our website at www.kennedymfg.com

Kennedy modular cabinets are custom-designed around the specific needs of your operation. Kennedy's web configurator allows you to quickly choose and configure your drawer arrangements, select drawer divider options for each individual drawer, and select accessories and color combinations for your cabinet, even for each individual drawer.

Easy Navigation

The configurator makes customizing your modular cabinets easy!

- Product Selection
- Drawer Sizes
- Drawer Dividers
- Color combinations down to individual drawers!

Customization

- Kennedy's web product configurator is flexible
- Provides 9 colors in any drawer/body combination
- Change drawer heights in the field for future needs



Kennedy High-Density Modular Cabinets

Kennedy modular cabinets and products provide specific benefits across a wide range of industrial and commercial applications. Key application benefits are higher productivity, storage maximization, security and safety.

Our modular products provide a high-density solution to making your storage space perform any time your operations involve the storing and retrieval of tools, parts or supplies by specialized technicians or personnel.

These modular cabinets are custom-designed around the specific needs of your operation. Kennedy's web configurator allows you to quickly choose and configure your drawer arrangements, select drawer divider options for each individual drawer, and select accessories and color combinations for your cabinet, even for each individual drawer.

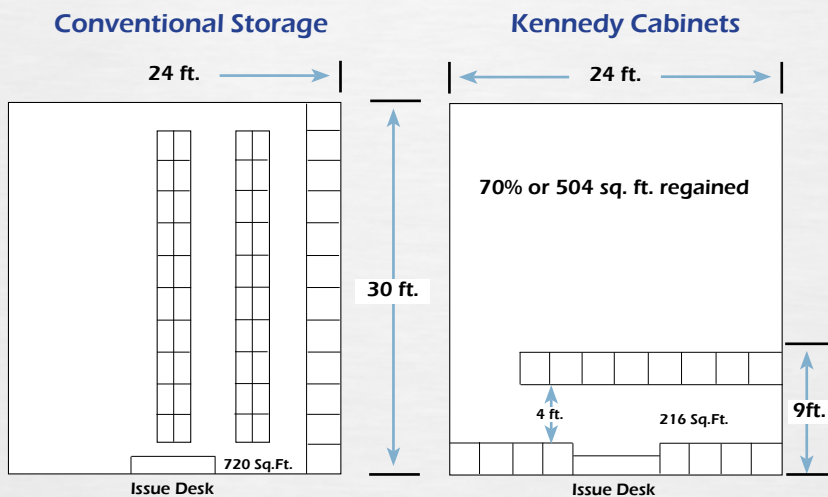

Conventional Storage
 68 Sections of Conventional Shelving with
 38 opening/Section = 2,584 compartments.
AVERAGE RETRIEVAL TIME PER ITEM = 3-4 MINUTES

V.S.

Kennedy Cabinets
 16 Kennedy Cabinets with 748 drawers,
 172 compartments = 2,752 compartments.
AVERAGE RETRIEVAL TIME PER ITEM = 1 MINUTE

Benchmark Series®

The ultimate in tool storage for the mechanic, the Benchmark Series has everything you want and more. From the safety of gas shock lid stays to rugged, heavy-duty casters, Benchmark is job ready. Made in the USA, you'll get Kennedy quality that will last a lifetime. Extra wide drawers can hold up to 420 lbs. Large bank drawers on all 53" and 60" also have 220 lb slides.

Product Features:



Gas-Shock Lid Stays



Smooth Operating Ball-Bearing Drawer Slides Hold Up to 120 lbs Each. Extra Wide Drawers Hold Up to 420 lbs Each.



High Security Tubular Locking System



Heavy-Duty 6" x 2" Roller Bearing Casters with 900 lb Capacity Per Caster

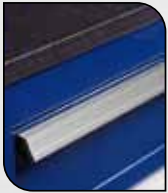

Full-Width, Extruded Aluminum Drawer Pulls w/ Black Plastic Endcaps & Coated MDF Work Surface on Roller Cabinets.



Aluminum Corner Trim Protects Against Nicks and Scrapes



Soft Rubber Ergonomic Push Handle



Pictured: 60" Benchmark 7 Drawer Top Chest & 11 Drawer Roller Cabinet Combo in Classic Blue



Customize the color of your products. Simply place one of the abbreviations at the end of the model number.



Extra lead time required.

METAL THICKNESS	
Frame	16 ga
Drawers	18 ga
Extra Wide Drawers	14 ga

60" BENCHMARK SERIES

- Ball-Bearing Drawer Slides That Move Easily Under Heavy Drawer Loads
- Heavy Duty, Non-Slip Drawer Liners & Full-Width Aluminum Drawer Pulls
- Large 6" x 2" Roller Bearing Heavy Duty Casters
- Metal Thickness: Body - 16 ga., Drawers - 18 ga., X-Wide Drawers - 14 ga.



7-DR CHEST	DRS.	WIDTH	DEPTH	HEIGHT	CAPACITY
TOP TILL:	-	60"	23"	4 3/8"	-
SMALL BANK:	2	12 7/8"	22 3/8"	2"	120 lbs.
	2	12 7/8"	22 3/8"	4"	120 lbs.
LARGE BANK:	3	38 7/8"	22 3/8"	4"	220 lbs.

11-DR CABINET	DRS.	WIDTH	DEPTH	HEIGHT	CAPACITY
TOP DRAWER:	1	54 3/8"	22 3/8"	5"	440 lbs.
SMALL BANK:	2	12 7/8"	22 3/8"	2"	120 lbs.
	3	12 7/8"	22 3/8"	4"	120 lbs.
	1	12 7/8"	22 3/8"	6"	120 lbs.
LARGE BANK:	3	38 7/8"	22 3/8"	4"	220 lbs.
	1	38 7/8"	22 3/8"	10"	220 lbs.

MASTER No.	ITEM DESCRIPTION	WIDTH	DEPTH	HEIGHT	NET WT	SHIP WT	CAPACITY
60000	7-Drawer Top Chest	60"	24"	20 1/2"	280 lbs.	355 lbs.	18,853 cu. in.
60101	Top Canopy	60"	24"	22 3/4"	90 lbs.	165 lbs.	24,500 cu. in.
60121	11-Drawer Cabinet	60"	24"	44 1/2"	460 lbs.	485 lbs.	30,094 cu. in.

53" BENCHMARK SERIES

- Ball-Bearing Drawer Slides That Move Easily Under Heavy Drawer Loads
- Heavy Duty, Non-Slip Drawer Liners & Full-Width Aluminum Drawer Pulls
- Large 6" x 2" Roller Bearing Heavy Duty Casters
- Metal Thickness: Body - 16 ga., Drawers - 18 ga., X-Wide Drawers - 14 ga.



7-DR CHEST	DRS.	WIDTH	DEPTH	HEIGHT	CAPACITY
TOP TILL:	-	53"	23"	4 3/8"	-
SMALL BANK:	2	12 7/8"	22 3/8"	2"	120 lbs.
	2	12 7/8"	22 3/8"	4"	120 lbs.
LARGE BANK:	3	31 7/8"	22 3/8"	4"	220 lbs.

11-DR CABINET	DRS.	WIDTH	DEPTH	HEIGHT	CAPACITY
TOP DRAWER:	1	47 3/8"	22 3/8"	5"	440 lbs.
SMALL BANK:	2	12 7/8"	22 3/8"	2"	120 lbs.
	3	12 7/8"	22 3/8"	4"	120 lbs.
	1	12 7/8"	22 3/8"	6"	120 lbs.
LARGE BANK:	3	31 7/8"	22 3/8"	4"	220 lbs.
	1	31 7/8"	22 3/8"	10"	220 lbs.

MASTER No.	ITEM DESCRIPTION	WIDTH	DEPTH	HEIGHT	NET WT	SHIP WT	CAPACITY
53000	7-Drawer Top Chest	53"	24"	20 1/2"	260 lbs.	335 lbs.	16,494 cu. in.
53101	Top Canopy	53"	24"	22 3/4"	85 lbs.	160 lbs.	21,250 cu. in.
53001	11-Drawer Cabinet	53"	24"	44 1/2"	460 lbs.	485 lbs.	26,815 cu. in.

46" BENCHMARK SERIES

- Ball-Bearing Drawer Slides That Move Easily Under Heavy Drawer Loads
- Heavy Duty, Non-Slip Drawer Liners & Full-Width Aluminum Drawer Pulls
- Large 6" x 2" Roller Bearing Heavy Duty Casters
- Metal Thickness: Body - 16 ga., Drawers - 18 ga., X-Wide Drawers - 14 ga.



8-DR CHEST	DRS.	WIDTH	DEPTH	HEIGHT	CAPACITY
TOP TILL:	-	46"	23"	4 3/8"	-
SMALL BANK:	2	12 7/8"	22 3/8"	2"	120 lbs.
	2	12 7/8"	22 3/8"	4"	120 lbs.
LARGE BANK:	2	24 7/8"	22 3/8"	2"	120 lbs.
	2	24 7/8"	22 3/8"	4"	120 lbs.

11-DR CABINET	DRS.	WIDTH	DEPTH	HEIGHT	CAPACITY
TOP DRAWER:	1	40 3/8"	22 3/8"	5"	440 lbs.
SMALL BANK:	2	12 7/8"	22 3/8"	2"	120 lbs.
	1	12 7/8"	22 3/8"	4"	120 lbs.
	1	12 7/8"	22 3/8"	6"	120 lbs.
	1	12 7/8"	22 3/8"	8"	120 lbs.
LARGE BANK:	1	24 7/8"	22 3/8"	2"	120 lbs.
	2	24 7/8"	22 3/8"	4"	120 lbs.
	1	24 7/8"	22 3/8"	6"	120 lbs.
	1	24 7/8"	22 3/8"	8"	120 lbs.

MASTER No.	ITEM DESCRIPTION	WIDTH	DEPTH	HEIGHT	NET WT	SHIP WT	CAPACITY
46000	8-Drawer Top Chest	46"	24"	20 1/2"	210 lbs.	230 lbs.	13,835 cu. in.
46101	Top Canopy	46"	24"	22 3/4"	125 lbs.	130 lbs.	18,000 cu. in.
46003	11-Drawer Cabinet	46"	24"	42 5/8"	425 lbs.	450 lbs.	22,072 cu. in.

BENCHMARK SERIES FULL-HEIGHT SIDE LOCKER

- Reversible - Hangs on Either Side of Roller Cabinets
- Includes 3 Drawers, w/Ball-Bearing Slides and 1 Stationary, Adjustable Shelf
- Fits Any 24" Deep Benchmark Cabinet or Combo
- Metal Thickness: Body - 16 ga. Drawers - 18 ga.



3-DR LOCKER	DRS.	WIDTH	DEPTH	HEIGHT	CAPACITY
DRAWERS:	3	19 1/2"	22 1/2"	4"	120 lbs.
SHELF:	1	19 1/2"	22 1/2"	1"	120 lbs.

MASTER No.	ITEM DESCRIPTION	WIDTH	DEPTH	HEIGHT	NET WT	SHIP WT	CAPACITY
40200	3-Drawer Side Locker	26 3/8"	24"	62"	160 lbs.	200 lbs.	27,000 cu. in.

BENCHMARK SERIES 6-DRAWER SIDE CABINET

- Fits Any 24" Deep Benchmark Series Roller Cabinet
- Reversible - Hangs on Either Side of Roller Cabinets
- Heavy Duty, Non-Slip Drawer Liners & Full-Width Aluminum Drawer Pulls
- Metal Thickness: Body - 16 ga. Drawers - 18 ga.
- Includes MDF Work Surface



MODEL: 20200	DRS.	WIDTH	DEPTH	HEIGHT	CAPACITY
DRAWERS:	1	15"	22 1/2"	6"	120 lbs.
	2	15"	22 1/2"	2"	120 lbs.
	1	15"	22 1/2"	4"	120 lbs.
	1	15"	22 1/2"	6"	120 lbs.
	1	15"	22 1/2"	8"	120 lbs.

MASTER No.	ITEM DESCRIPTION	WIDTH	DEPTH	HEIGHT	NET WT	SHIP WT	CAPACITY
20200	6-Drawer Side Cabinet	21"	24"	35 3/4"	170 lbs.	220 lbs.	7,622 cu. in.

Maintenance Pro™

Kennedy MP Series

Specially designed for the maintenance professional, Maintenance Pro™ brings a wide variety of products to your shop.

Product Features:



Gas-Shock Lid Stays In Top Chests & Canopies



Smooth Operating Ball-Bearing Drawer Slides Hold Up to 120 lbs Per Drawer



High Security Tubular Locking System



Rugged 6" x 2" Roller Bearing Casters with 900 lb Capacity/Caster



Full-Width, Extruded Aluminum Drawer Pulls



Tubular Steel Side Handles



Coated MDF Work Surface



Pictured: 53" Maintenance Pro Series Top Canopy & 12-Drawer Roller Cabinet Combo in Yellow



Customize the color of your products. Simply place one of the abbreviations at the end of the model number.



Extra lead time required.

METAL THICKNESS	
Frame	16 ga
Drawers	18 ga
53" Model Drawers	20 ga

53" MAINTENANCE PRO SERIES

- Ball-Bearing Drawer Slides That Move Easily Under Heavy Drawer Loads
- Heavy Duty, Non-Slip Drawer Liners & Full-Width Aluminum Drawer Pulls
- Large 6" x 2" Roller Bearing Heavy Duty Casters
- Metal Thickness: Body - 16 ga. Drawers - 20 ga.

8-DR CHEST	DRS.	WIDTH	DEPTH	HEIGHT	CAPACITY
TOP TILL:	-	53 1/4"	17 7/8"	2 1/2"	-
DRAWERS:	4	23"	16 1/2"	2"	120 lbs.
	4	23"	16 1/2"	4"	120 lbs.

12-DR CART	DRS.	WIDTH	DEPTH	HEIGHT	CAPACITY
TOP DRAWER:	1	49"	16 1/2"	3 5/8"	120 lbs.
LEFT BANK:	2	23"	16 1/2"	2"	120 lbs.
	3	23"	16 1/2"	4"	120 lbs.
	1	23"	16 1/2"	6"	120 lbs.
RIGHT BANK:	2	23"	16 1/2"	2"	120 lbs.
	2	23"	16 1/2"	4"	120 lbs.
	1	23"	16 1/2"	10"	120 lbs.

MASTER No.	ITEM DESCRIPTION	WIDTH	DEPTH	HEIGHT	NET WT	SHIP WT	CAPACITY
5302MP	8-Drawer Top Chest	53"	18"	18 1/2"	155 lbs.	185 lbs.	12,060 cu. in.
5350MP	Top Canopy	53"	18"	20"	75 lbs.	85 lbs.	17,780 cu. in.
5300MP	12-Drawer Cart	53"	18"	41 3/4"	335 lbs.	365 lbs.	19,992 cu. in.

42" MAINTENANCE PRO SERIES

- Ball-Bearing Drawer Slides That Move Easily Under Heavy Drawer Loads
- Heavy Duty, Non-Slip Drawer Liners & Full-Width Aluminum Drawer Pulls
- Large 6" x 2" Roller Bearing Heavy Duty Casters
- Metal Thickness: Body - 16 ga. Drawers - 18 ga.

7-DR CHEST	DRS.	WIDTH	DEPTH	HEIGHT	CAPACITY
TOP TILL:	-	41 1/4"	19 3/4"	4 3/4"	120 lbs.
LEFT BANK:	2	25 1/4"	18 1/2"	2"	120 lbs.
	1	25 1/4"	18 1/2"	4"	120 lbs.
RIGHT BANK:	2	9 3/4"	18 1/2"	2"	120 lbs.
	1	9 3/4"	18 1/2"	4"	120 lbs.
BOTTOM DRAWER:	1	37 1/4"	18 1/2"	5"	120 lbs.

12-DR CART	DRS.	WIDTH	DEPTH	HEIGHT	CAPACITY
TOP DRAWER:	1	37 1/4"	18 1/2"	5"	120 lbs.
LEFT BANK:	2	23"	18 1/2"	2"	120 lbs.
	3	23"	18 1/2"	4"	120 lbs.
	1	23"	18 1/2"	6"	120 lbs.
RIGHT BANK:	2	9 3/4"	18 1/2"	2"	120 lbs.
	2	9 3/4"	18 1/2"	4"	120 lbs.
	1	9 3/4"	18 1/2"	10"	120 lbs.

MASTER No.	ITEM DESCRIPTION	WIDTH	DEPTH	HEIGHT	NET WT	SHIP WT	CAPACITY
4202MP	7-Drawer Top Chest	41 1/4"	20"	21 1/2"	125 lbs.	155 lbs.	11,617 cu. in.
4200MP	12-Drawer Cart	41 1/4"	20"	42"	250 lbs.	280 lbs.	16,686 cu. in.

34" MAINTENANCE PRO SERIES

- Ball-Bearing Drawer Slides That Move Easily Under Heavy Drawer Loads
- Heavy Duty, Non-Slip Drawer Liners & Full-Width Aluminum Drawer Pulls
- Large 6" x 2" Roller Bearing Heavy Duty Casters
- Metal Thickness: Body - 16 ga. Drawers - 18 ga.

MODEL: 3400MP	DRS.	WIDTH	DEPTH	HEIGHT	CAPACITY
TOP TILL:	-	33 3/4"	19 1/2"	3 5/8"	120 lbs.
DRAWERS:	4	30"	18 1/2"	2"	120 lbs.
	1	30"	18 1/2"	4"	120 lbs.

MODEL: 3412MP	DRS.	WIDTH	DEPTH	HEIGHT	CAPACITY
TOP TILL:	-	33 7/8"	19 3/4"	2 5/8"	120 lbs.
DRAWERS:	9	9 3/16"	18"	2"	120 lbs.
	2	30"	18"	2"	120 lbs.
	1	30"	18"	4"	120 lbs.

MODEL: 3407MP	DRS.	WIDTH	DEPTH	HEIGHT	CAPACITY
DRAWERS:	3	30"	18 1/2"	2"	120 lbs.
	3	30"	18 1/2"	4"	120 lbs.
	1	30"	18 1/2"	10"	120 lbs.

MASTER No.	ITEM DESCRIPTION	WIDTH	DEPTH	HEIGHT	NET WT	SHIP WT	CAPACITY
3400MP	5-Drawer Top Chest	34"	20"	18 3/8"	146 lbs.	156 lbs.	8,225 cu. in.
3412MP	12-Drawer Top Chest	34"	20"	20 7/8"	181 lbs.	196 lbs.	8,331 cu. in.
3407MP	7-Drawer Cabinet	34"	20"	40 1/8"	209 lbs.	231 lbs.	14,517 cu. in.



29" MAINTENANCE PRO SERIES

- Ball-Bearing Drawer Slides That Move Easily Under Heavy Drawer Loads
- Heavy Duty, Non-Slip Drawer Liners & Full-Width Aluminum Drawer Pulls
- Large 6" x 2" Roller Bearing Heavy Duty Casters
- Metal Thickness: Body - 16 ga. Drawers - 18 ga.

MODEL: 2905MP DRS.	WIDTH	DEPTH	HEIGHT	CAPACITY	
TOP TILL:	-	28 13/16"	19 3/4"	3 11/16"	120 lbs.
DRAWERS:	4	25 1/16"	18 1/2"	2"	120 lbs.
	1	25 1/16"	18 1/2"	4"	120 lbs.

MODEL: 2912MP DRS.	WIDTH	DEPTH	HEIGHT	CAPACITY	
TOP TILL:	-	28 7/8"	19 3/4"	2 5/8"	120 lbs.
DRAWERS:	9	7 9/16"	18 1/2"	2"	120 lbs.
	2	25"	18 1/2"	2"	120 lbs.
	1	25"	18 1/2"	4"	120 lbs.

MODEL: 2907MP DRS.	WIDTH	DEPTH	HEIGHT	CAPACITY	
DRAWERS:	3	25"	18 1/2"	2"	120 lbs.
	3	25"	18 1/2"	4"	120 lbs.
	1	25"	18 1/2"	10"	120 lbs.



5-Drawer Top Chest



12-Drawer Chest
&
7-Drawer Cabinet Combo

MASTER No.	ITEM DESCRIPTION	WIDTH	DEPTH	HEIGHT	NET WT	SHIP WT	CAPACITY
2905MP	5-Drawer Top Chest	29"	20"	18 3/8"	105 lbs.	114 lbs.	7,077 cu. in.
2912MP	12-Drawer Top Chest	29"	20"	20 7/8"	166 lbs.	181 lbs.	7,326 cu. in.
2907MP	7-Drawer Cabinet	29"	20"	40 1/2"	198 lbs.	215 lbs.	12,122 cu. in.

MAINTENANCE PRO SERIES SIDE ATTACHMENTS

- Reversible - Hangs on Either Side of MP Cabinets/Carts
- Models 382MP & 306MP Have 6 Drawers, w/Ball-Bearing Slides
- Models 380MP & 300MP Have 2 Adjustable Shelves, w/Ball-Bearing Slides
- Metal Thickness: Body - 16 ga. Drawers - 18 ga.
- Model 382MP is Compatible with 53" MP Cabinets/Carts
- Model 306MP is Compatible with 29", 34", 39", 42" & 52" MP Cabinets/Carts
- Model 380MP is Compatible with 53" MP Cabinets/Carts
- Model 300MP is Compatible with 29", 34", 39", 42" & 52" MP Cabinets/Carts

MODEL: 382MP DRS.	WIDTH	DEPTH	HEIGHT	CAPACITY	
DRAWERS:	1	9 3/4"	16 1/2"	2"	120 lbs.
	4	9 3/4"	16 1/2"	4"	120 lbs.
	1	9 3/4"	16 1/2"	10"	120 lbs.

MODEL: 306MP DRS.	WIDTH	DEPTH	HEIGHT	CAPACITY	
DRAWERS:	1	9 3/4"	18 1/2"	2"	120 lbs.
	4	9 3/4"	18 1/2"	4"	120 lbs.
	1	9 3/4"	18 1/2"	10"	120 lbs.

MODEL: 380MP No.	WIDTH	DEPTH	HEIGHT	CAPACITY	
SHELVES:	2	9 3/4"	16 1/2"	2"	120 lbs.

MODEL: 300MP No.	WIDTH	DEPTH	HEIGHT	CAPACITY	
SHELVES:	1	9 3/4"	18 1/2"	2"	120 lbs.

MASTER No.	ITEM DESCRIPTION	WIDTH	DEPTH	HEIGHT	NET WT	SHIP WT	CAPACITY
382MP	6-Drawer Side Cabinet	13 3/8"	18"	33 1/8"	89 lbs.	94 lbs.	4,231 cu. in.
306MP	6-Drawer Side Cabinet	13 3/8"	20"	33 1/8"	94 lbs.	100 lbs.	4,742 cu. in.
380MP	2-Shelf Side Locker	13 3/8"	18"	33 1/8"	53 lbs.	58 lbs.	6,300 cu. in.
300MP	2-Shelf Side Locker	13 3/8"	20"	33 1/8"	56 lbs.	61 lbs.	7,000 cu. in.



6-Drawer Side Cabinet



2-Shelf Side Cabinet

58" MP SERIES MAINTENANCE CART

- Ball-Bearing Drawer Slides That Move Easily Under Heavy Drawer Loads
- Heavy Duty, Non-Slip Drawer Liners & Full-Width Aluminum Drawer Pulls
- Large 6" x 2" Roller Bearing Heavy Duty Casters & Two 10" Ball-Bearing Rubber Wheels
- Metal Thickness: Body - 16 ga. Drawers - 18 ga.

12-DR CART	DRS.	WIDTH	DEPTH	HEIGHT	CAPACITY
TOP DRAWER:	1	52 3/4"	18 1/2"	6"	220 lbs.
LEFT BANK:	2	25"	18 1/2"	2"	120 lbs.
	3	25"	18 1/2"	4"	120 lbs.
	1	25"	18 1/2"	6"	120 lbs.
RIGHT BANK:	2	25"	18 1/2"	2"	120 lbs.
	2	25"	18 1/2"	4"	120 lbs.
	1	25"	18 1/2"	10"	120 lbs.

MASTER No.	ITEM DESCRIPTION	WIDTH	DEPTH	HEIGHT	NET WT	SHIP WT	CAPACITY
5804MP	12-Drawer Cart	57 1/4"	20"	43 1/2"	388 lbs.	475 lbs.	23,934 cu. in.



44" MAINTENANCE PRO SERIES

- Ball-Bearing Drawer Slides That Move Easily Under Heavy Drawer Loads
- Heavy Duty, Non-Slip Drawer Liners & Full-Width Aluminum Drawer Pulls
- Large 6" x 2" Roller Bearing Heavy Duty Casters & Two 10" Ball-Bearing Rubber Wheels
- Metal Thickness: Body - 16 ga. Drawers - 18 ga.



MODEL: 4405MP DRS.	WIDTH	DEPTH	HEIGHT	CAPACITY	
DRAWERS:	4	25"	18 1/2"	2"	120 lbs.
	1	35"	18 1/2"	4"	120 lbs.
COMPARTMENT:	-	15 1/2"	19 3/8"	15 3/8"	120 lbs.

MODEL: 4400MP DRS.	WIDTH	DEPTH	HEIGHT	CAPACITY	
TOP DRAWER:	1	39 1/2"	18 1/2"	6"	120 lbs.
LEFT BANK:	3	12"	18 1/2"	4"	120 lbs.
	1	12"	18 1/2"	10"	120 lbs.
RIGHT BANK:	2	25"	18 1/2"	2"	120 lbs.
	3	25"	18 1/2"	4"	120 lbs.

MASTER No.	ITEM DESCRIPTION	WIDTH	DEPTH	HEIGHT	NET WT	SHIP WT	CAPACITY
4405MP__	5-Drawer Top Chest	43 3/4"	20"	16 1/2"	123 lbs.	137 lbs.	9,723 cu. in.
4400MP__	10-Drawer Cart	43 3/4"	20"	37 3/4"	316 lbs.	331 lbs.	14,305 cu. in.

39" MAINTENANCE PRO SERIES

- Ball-Bearing Drawer Slides That Move Easily Under Heavy Drawer Loads
- Heavy Duty, Non-Slip Drawer Liners & Full-Width Aluminum Drawer Pulls
- Large 6" x 2" Roller Bearing Heavy Duty Casters
- Top Chest Compartment Has Removable Partial Shelf
- Canopy Features Gas Struts & 10pc Assorted Hook Set
- Metal Thickness: Body - 16 ga. Drawers - 18 ga.



5-Drawer Top Chest



12-Drawer Chest/8-Drawer Cabinet Combo



Top Canopy/8-Drawer Cabinet Combo

MODEL: 3905MP DRS.	WIDTH	DEPTH	HEIGHT	CAPACITY	
TOP TILL:	-	39 1/6"	19 3/4"	3 5/8"	120 lbs.
DRAWERS:	4	39 3/8"	18 1/2"	2"	120 lbs.
	1	39 3/8"	18 1/2"	4"	120 lbs.

MODEL: 3912MP DRS.	WIDTH	DEPTH	HEIGHT	CAPACITY	
TOP TILL:	-	39 1/6"	19 3/4"	3 5/8"	120 lbs.
DRAWERS:	9	11"	18 1/2"	2"	120 lbs.
	2	39 3/8"	18 1/2"	2"	120 lbs.
	1	39 3/8"	18 1/2"	4"	120 lbs.

MODEL: 3900MP DRS.	WIDTH	DEPTH	HEIGHT	CAPACITY	
DRAWERS:	3	35"	18 1/2"	2"	120 lbs.
	4	35"	18 1/2"	4"	120 lbs.
	1	35"	18 1/2"	6"	120 lbs.

MASTER No.	ITEM DESCRIPTION	WIDTH	DEPTH	HEIGHT	NET WT	SHIP WT	CAPACITY
39100MP__	Top Canopy	39"	18"	21"	69 lbs.	74 lbs.	-
3905MP__	5-Drawer Chest	39 1/4"	20"	18 3/8"	130 lbs.	140 lbs.	9,857 cu. in.
3912MP__	12-Drawer Chest	39 1/4"	20"	20 7/8"	193 lbs.	203 lbs.	10,313 cu. in.
3900MP__	8-Drawer Cart	39 3/8"	20"	42"	225 lbs.	250 lbs.	17,378 cu. in.

THE INDUSTRIAL SERIES

Product Features:



High Security Tubular Locking System



Heavy-Duty 5" Casters On All Models



Choose Between Standard Friction Slides or Smooth Operating Ball-Bearing Drawer Slides That Hold Up to 120 lbs Per Drawer



Tubular Steel Side Handles



Extruded Aluminum Drawer Pulls

- 27" Wide roller cabinets accommodate 27" wide or smaller top chests and chest bases.
- 29" Wide roller cabinets accommodate 29" wide or smaller top chests and chest bases.



21041 ROLLER CABINET COMBINATION LOCK



The mechanical combination lock offers quick and easy access. No need to worry about lost or missing keys. In the event the combination is changed or forgotten, an emergency key override is included.

21042 ROLLER CABINET ELECTRONIC PUSH BUTTON LOCK



The electronic push button lock can store up to five user access codes simultaneously with a multitude of code sequences available. This lock is powered by a battery pack that services over 3,500 openings of the cart. A low-battery warning light indicates when the power supply is down to 1,500 openings.



Customize the color of your products. Simply place one of the abbreviations at the end of the model number.

Extra lead time required.

METAL THICKNESS

Frame	18 ga
Drawers	20 ga

27" 3-DRAWER INDUSTRIAL ROLLER CABINET

- 5" x 1 1/4" Roller Bearing Casters Hold Up to 200 lbs. Each
- Swing-Down Panel Conceals and Secures Spacious Storage Compartment
- Metal Thickness: Body - 18 ga. Drawers - 20 ga.
- Model 273 - Features Friction Slides
- Model 273X - Features Ball-Bearing Slides

3-DR CABINET	DRS.	WIDTH	DEPTH	HEIGHT	CAPACITY
DRAWERS:	2	23"	16 1/2"	4"	120 lbs.
	1	23"	16 1/2"	6"	120 lbs.
COMPARTMENT:	-	24 1/8"	17 3/4"	11 1/4"	120 lbs.

MASTER No.	ITEM DESCRIPTION	WIDTH	DEPTH	HEIGHT	NET WT	SHIP WT	CAPACITY
273/273X	3-Drawer Cabinet	27"	18"	35"	99/102 lbs.	110/113 lbs.	8,235 cu. in.



Swing-Down Panel Open

27" & 29" 5-DRAWER INDUSTRIAL ROLLER CABINETS

- Swing-Down Panels Conceal and Secure Spacious Storage Compartments

27" ROLLER CABINET

- 5" x 1 1/4" Roller Bearing Casters Hold Up to 200 lbs. Each
- Model 275 - Features Friction Slides
- Model 275X - Features Ball-Bearing Slides

29" ROLLER CABINET

- 5" x 2" Roller Bearing Casters Hold Up to 350 lbs. Each
- Model 295 - Features Friction Slides
- Model 295X - Features Ball-Bearing Slides

Metal Thickness: Body - 18 ga. Drawers - 20 ga.

27" CABINET	DRS.	WIDTH	DEPTH	HEIGHT	CAPACITY
DRAWERS:	3	23"	16 1/2"	4"	120 lbs.
	2	23"	16 1/2"	6"	120 lbs.
COMPARTMENT:	-	24 1/8"	17 3/4"	11 1/4"	120 lbs.

29" CABINET	DRS.	WIDTH	DEPTH	HEIGHT	CAPACITY
DRAWERS:	3	25"	18 1/2"	2"	120 lbs.
	2	25"	18 1/2"	4"	120 lbs.
COMPARTMENT:	-	26 1/8"	19 3/4"	11 1/4"	120 lbs.

MASTER No.	ITEM DESCRIPTION	WIDTH	DEPTH	HEIGHT	NET WT	SHIP WT	CAPACITY
275/275X	5-Drawer Cabinet	27"	18"	35"	110/115 lbs.	121/126 lbs.	8,003 cu. in.
295/295X	5-Drawer Cabinet	29"	20"	35"	128/133 lbs.	140/145 lbs.	9,720 cu. in.



27" & 29" 7-DRAWER INDUSTRIAL ROLLER CABINETS

27" ROLLER CABINET

- 5" x 1 1/4" Roller Bearing Casters Hold Up to 200 lbs. Each
- Model 277 - Features Friction Slides
- Model 277X - Features Ball-Bearing Slides

29" ROLLER CABINET

- 5" x 2" Roller Bearing Casters Hold Up to 350 lbs. Each
- Model 297 - Features Friction Slides
- Model 297X - Features Ball-Bearing Slides

Metal Thickness: Body - 18 ga. Drawers - 20 ga.

27" CABINET	DRS.	WIDTH	DEPTH	HEIGHT	CAPACITY
DRAWERS:	3	23"	16 1/2"	2"	120 lbs.
	3	23"	16 1/2"	4"	120 lbs.
	1	23"	16 1/2"	6"	120 lbs.

29" CABINET	DRS.	WIDTH	DEPTH	HEIGHT	CAPACITY
DRAWERS:	3	25"	18 1/2"	2"	120 lbs.
	3	25"	18 1/2"	4"	120 lbs.
	1	25"	18 1/2"	6"	120 lbs.

MASTER No.	ITEM DESCRIPTION	WIDTH	DEPTH	HEIGHT	NET WT	SHIP WT	CAPACITY
277/277X	7-Drawer Cabinet	27"	18"	35"	127/134 lbs.	138/145 lbs.	8,404 cu. in.
297/297X	7-Drawer Cabinet	29"	20"	35"	146/153 lbs.	158/165 lbs.	10,235 cu. in.



27" 6-DRAWER INDUSTRIAL ROLLER CABINET

- 5" x 2" Roller Bearing Casters Hold Up to 350 lbs. Each
- Swing-Down Panel Conceals and Secures Spacious Storage Compartment
- Metal Thickness: Body - 18 ga. Drawers - 20 ga.
- Model 376X - Features Ball-Bearing Slides

6-DR CABINET	DRS.	WIDTH	DEPTH	HEIGHT	CAPACITY
DRAWERS:	3	23"	16 1/2"	2"	120 lbs.
	3	23"	16 1/2"	4"	120 lbs.
COMPARTMENT:	-	24 1/8"	17 3/4"	11 1/4"	120 lbs.

MASTER No.	ITEM DESCRIPTION	WIDTH	DEPTH	HEIGHT	NET WT	SHIP WT	CAPACITY
376X	6-Drawer Cabinet	27"	18"	39"	137 lbs.	148 lbs.	9,426 cu. in.





27" 8-DRAWER INDUSTRIAL ROLLER CABINET

- 5" x 2" Roller Bearing Casters Hold Up to 350 lbs. Each
- Holds a Variety of Tools at Work Station Height
- Metal Thickness: Body - 18 ga. Drawers - 20 ga.
- Model 378X - Features Ball-Bearing Slides

8-DR CABINET	DRS.	WIDTH	DEPTH	HEIGHT	CAPACITY
DRAWERS:	3	23"	16 1/2"	2"	120 lbs.
	4	23"	16 1/2"	4"	120 lbs.
	1	23"	16 1/2"	6"	120 lbs.

MASTER No.	ITEM DESCRIPTION	WIDTH	DEPTH	HEIGHT	NET WT	SHIP WT	CAPACITY
378X___	8-Drawer Cabinet	27"	18"	39"	154 lbs.	165 lbs.	9,826 cu. in.

34" 8-DRAWER INDUSTRIAL ROLLER CABINET

- 5" x 2" Roller Bearing Casters Hold Up to 350 lbs. Each
- Holds a Variety of Tools at Work Station Height
- Metal Thickness: Body - 18 ga. Drawers - 20 ga.
- Model 348X - Features Ball-Bearing Slides

8-DR CABINET	DRS.	WIDTH	DEPTH	HEIGHT	CAPACITY
DRAWERS:	3	30"	18 1/2"	2"	120 lbs.
	4	30"	18 1/2"	4"	120 lbs.
	1	30"	18 1/2"	6"	120 lbs.

MASTER No.	ITEM DESCRIPTION	WIDTH	DEPTH	HEIGHT	NET WT	SHIP WT	CAPACITY
348X___	8-Drawer Cabinet	34"	20"	40"	206 lbs.	228 lbs.	14,319 cu. in.

21" 4-DRAWER INDUSTRIAL ROLLER CABINET

- 5" x 1 1/4" Roller Bearing Casters Hold Up to 200 lbs. Each
- Ball-Bearing Drawer Slides and Tubular Push Handle Included
- Small in Size, But Big on Security!
- Metal Thickness: Body - 18 ga. Drawers - 20 ga.
- Model 21040 - Features High-Security Tubular Locking System
- Model 21041 - Features Combination Push Button Locking System
- Model 21042 - Features Electronic Push Button Locking System

4-DR CABINET	DRS.	WIDTH	DEPTH	HEIGHT	CAPACITY
DRAWERS:	2	16 1/2"	16 1/2"	3"	120 lbs.
	1	16 1/2"	16 1/2"	6 1/4"	120 lbs.
	1	16 1/2"	16 1/2"	9 1/2"	120 lbs.

MASTER No.	ITEM DESCRIPTION	WIDTH	DEPTH	HEIGHT	NET WT	SHIP WT	CAPACITY
21040/41/42___	4-Drawer Cabinet	20 1/2"	18"	34"	103 lbs.	133 lbs.	5,950 cu. in.

INDUSTRIAL SERIES 2-SHELF SIDE LOCKERS

- Locking Door & 2 Adjustable Pull-Out Shelves with Ball-Bearing Slides.
- Hangs on Either Side of Your Roller Cabinet.
- Metal Thickness: Body - 18 ga. Drawers - 20 ga.
- Model 182X - Fits Models 273(X), 275(X), 277(X), 310(X), & 10491
- Model 202X - Fits Models 295(X), 297(X), 4410, & 4400MP
- Model 382X - Fits Models 376X, 378X, 315X, 10492, & 10493
- Model 302X - Fits Models 348X, 10495, & 10494

2-SHELF LOCKERS	DRS.	WIDTH	DEPTH	HEIGHT	CAPACITY
SHELVES:	2	9 3/4"	16 1/2"	2"	120 lbs.

MASTER No.	ITEM DESCRIPTION	WIDTH	DEPTH	HEIGHT	NET WT	SHIP WT	CAPACITY
182X___	2-Shelf Locker	13 5/8"	18"	29"	45 lbs.	49 lbs.	5,500 cu. in.
202X___	2-Shelf Locker	13 5/8"	20"	29"	47 lbs.	52 lbs.	6,116 cu. in.
382X___	2-Shelf Locker	13 5/8"	18"	33 1/8"	53 lbs.	58 lbs.	6,300 cu. in.
302X___	2-Shelf Locker	13 5/8"	20"	33 1/8"	56 lbs.	61 lbs.	7,000 cu. in.

INDUSTRIAL SERIES FOLD-AWAY CABINET SHELF

- Folds Flat When Not In Use
- Raised Sides Keep Tools From Falling Off
- Fits Any Industrial, Maintenance Pro, or Pro Line Roller Cabinet
- Weight Capacity: 40 lbs.

MASTER No.	ITEM DESCRIPTION	WIDTH	DEPTH	HEIGHT	NET WT	SHIP WT	CAPACITY
DS1___	Cabinet Shelf	20 1/8"	17 1/4"	1"	10.5 lbs.	11 lbs.	343 sq. in.



Shelf "Closed"

Shelf "Open"

INDUSTRIAL SERIES 5-DRAWER SIDE CABINETS

18" DEEP SIDE CABINET

- Model 185 - Features Friction Slides
- Model 185X - Features Ball-Bearing Slides
- Fits Models 273(X), 275(X), 277(X), 310X, & 10491

20" DEEP SIDE CABINET

- Model 205 - Features Friction Slides
- Model 205X - Features Ball-Bearing Slides
- Fits Models 295(X), 297(X), 4410, & 4400MP

Hangs on Either Side of Your Rolling Cabinet

Metal Thickness: Body - 18 ga. Drawers - 20 ga.

185/185X	DRS.	WIDTH	DEPTH	HEIGHT	CAPACITY
DRAWERS:	1	9 3/4"	16 1/2"	2"	120 lbs.
	3	9 3/4"	16 1/2"	4"	120 lbs.
	1	9 3/4"	16 1/2"	10"	120 lbs.

205/205X	DRS.	WIDTH	DEPTH	HEIGHT	CAPACITY
DRAWERS:	1	9 3/4"	18 1/2"	2"	120 lbs.
	3	9 3/4"	18 1/2"	4"	120 lbs.
	1	9 3/4"	18 1/2"	10"	120 lbs.

MASTER No.	ITEM DESCRIPTION	WIDTH	DEPTH	HEIGHT	NET WT	SHIP WT	CAPACITY
185/185X	5-Drawer Cabinet	13 3/8"	18"	29"	67/72 lbs.	71/76 lbs.	3,634 cu. in.
205/205X	5-Drawer Cabinet	13 3/8"	20"	29"	99/102 lbs.	99/102 lbs.	4,073 cu. in.



INDUSTRIAL SERIES 6-DRAWER SIDE CABINETS

- Hangs on Either Side of Your Rolling Cabinet
- Ball-Bearing Drawer Slides in Every Drawer
- Metal Thickness: Body - 18 ga. Drawers - 20 ga.
- Model 386X - Fits Models 376X, 378X, 10492, 10493, & 315X
- Model 306X - Fits Models 348X, 2907X, 3407X, 10494, & 10495

MODEL: 386X	DRS.	WIDTH	DEPTH	HEIGHT	CAPACITY
DRAWERS:	1	9 3/4"	16 1/2"	2"	120 lbs.
	4	9 3/4"	16 1/2"	4"	120 lbs.
	1	9 3/4"	16 1/2"	10"	120 lbs.

MODEL: 306X	DRS.	WIDTH	DEPTH	HEIGHT	CAPACITY
DRAWERS:	1	9 3/4"	18 1/2"	2"	120 lbs.
	4	9 3/4"	18 1/2"	4"	120 lbs.
	1	9 3/4"	18 1/2"	10"	120 lbs.

MASTER No.	ITEM DESCRIPTION	WIDTH	DEPTH	HEIGHT	NET WT	SHIP WT	CAPACITY
386X	6-Drawer Cabinet	13 3/8"	18"	33 1/8"	89 lbs.	94 lbs.	4,231 cu. in.
306X	6-Drawer Cabinet	13 3/8"	20"	33 1/8"	94 lbs.	100 lbs.	4,742 cu. in.



VERSA-CART® 5-DRAWER TOOL CARTS

- 1,000 lbs. Capacity, Supported by 10" Ball-Bearing Wheels & Heavy-Duty 5" x 2" Casters
- Includes Deck of 16 ga. Steel with 1 1/2" High Sides, Tubular Side Handle, & Hardware
- Use With Any 27"W x 35"H Cabinet. Metal Thickness: Body - 18 ga. Drawers - 20 ga.
- Model 415 - Includes 410 Platform and 185 5-Drawer Cabinet with Friction Slides
- Model 415X - Includes 410 Platform and 185X 5-Drawer Cabinet with Ball-Bearing Slides
- Model 435 - Includes 430 Platform and 205 5-Drawer Cabinet with Friction Slides
- Model 435X - Includes 430 Platform and 205X 5-Drawer Cabinet with Ball-Bearing Slides

Create your own Versa-Cart® Tool Cart!



415/415X	DRS.	WIDTH	DEPTH	HEIGHT	CAPACITY
DRAWERS:	1	9 3/4"	16 1/2"	2"	120 lbs.
	3	9 3/4"	16 1/2"	4"	120 lbs.
	1	9 3/4"	16 1/2"	10"	120 lbs.

435/435X	DRS.	WIDTH	DEPTH	HEIGHT	CAPACITY
DRAWERS:	1	9 3/4"	18 1/2"	2"	120 lbs.
	3	9 3/4"	18 1/2"	4"	120 lbs.
	1	9 3/4"	18 1/2"	10"	120 lbs.

MASTER No.	ITEM DESCRIPTION	WIDTH	DEPTH	HEIGHT	NET WT	SHIP WT	CAPACITY
415/415X	5-Drawer Cabinet	41 1/8"	18 3/8"	36 1/4"	102/107 lbs.	112/117 lbs.	3,634 cu. in.
435/435X	5-Drawer Cabinet	43 1/8"	20 1/4"	36 1/4"	118/123 lbs.	131/136 lbs.	4,073 cu. in.

Create your own wheel and caster arrangement.

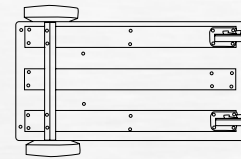

Maximum Stability

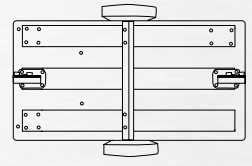

Maximum Maneuverability





INDUSTRIAL SERIES 10-DRAWER MAINTENANCE CART

- 5" x 2" Roller Bearing Casters Hold Up to 350 lbs. Each
- High Security Tubular Locking System
- Tubular Push Handle Included
- Metal Thickness: Body - 18 ga. Drawers - 20 ga.

10-DR CART	DRS.	WIDTH	DEPTH	HEIGHT	CAPACITY
DRAWERS:	3	23"	16 1/2"	4"	120 lbs.
	2	23"	16 1/2"	6"	120 lbs.
	3	9 5/8"	16 1/2"	4"	120 lbs.
	2	9 5/8"	16 1/2"	6"	120 lbs.

MASTER No.	ITEM DESCRIPTION	WIDTH	DEPTH	HEIGHT	NET WT	SHIP WT	CAPACITY
310X__	10-Drawer Cart	39 3/8"	18"	35"	180 lbs.	210 lbs.	11,551 cu. in.



INDUSTRIAL SERIES 15-DRAWER MAINTENANCE CART

- 5" x 2" Roller Bearing Casters Hold Up to 350 lbs. Each
- High Security Tubular Locking System
- Tubular Push Handle Included
- Metal Thickness: Body - 18 ga. Drawers - 20 ga.

15-DR CART	DRS.	WIDTH	DEPTH	HEIGHT	CAPACITY
DRAWERS:	5	23"	16 1/2"	2"	120 lbs.
	3	23"	16 1/2"	4"	120 lbs.
	1	23"	16 1/2"	6"	120 lbs.
	2	9 5/8"	16 1/2"	2"	120 lbs.
	3	9 5/8"	16 1/2"	4"	120 lbs.
	1	9 5/8"	16 1/2"	12"	120 lbs.

MASTER No.	ITEM DESCRIPTION	WIDTH	DEPTH	HEIGHT	NET WT	SHIP WT	CAPACITY
315X__	15-Drawer Cart	39 3/8"	18"	39"	230 lbs.	260 lbs.	13,054 cu. in.



INDUSTRIAL SERIES 5-DRAWER MAINTENANCE CHEST

- Fits Models 310X & 315X & Pro-Line™ Maintenance Carts
- High-Security Tubular Locking System
- Includes Heavy-Duty, Plated Lift Handles
- Full-Width Aluminum Drawer Pulls
- Ball-Bearing Drawer Slides in Every Drawer
- Compartment Has Removable Partial Shelf and Locking Door
- Metal Thickness: Body - 18 ga. Drawers - 20 ga.

5-DR CHEST	DRS.	WIDTH	DEPTH	HEIGHT	CAPACITY
DRAWERS:	4	23"	16 1/2"	2"	120 lbs.
	1	23"	16 1/2"	4"	120 lbs.
COMPARTMENT:	-	13 1/2"	17 3/4"	13 1/4"	120 lbs.

MASTER No.	ITEM DESCRIPTION	WIDTH	DEPTH	HEIGHT	NET WT	SHIP WT	CAPACITY
305X__	5-Drawer Chest	39 3/8"	18"	16 1/2"	93 lbs.	102 lbs.	7,707 cu. in.



44" INDUSTRIAL SERIES

- High-Security Tubular Locking System
- Ball-Bearing Drawer Slides For Smooth Operation
- Lockable Compartment in Top Chest with Removable Partial Shelf
- Tubular Push Handle Included with Roller Cabinet
- Large 6" x 2" Roller Bearing Heavy Duty Casters & Two 10" Ball-Bearing Rubber Wheels
- Metal Thickness: Body - 18 ga. Drawers - 20 ga.

5-DR CHEST	DRS.	WIDTH	DEPTH	HEIGHT	CAPACITY
DRAWERS:	4	25"	18 1/2"	2"	120 lbs.
	1	25"	18 1/2"	4"	120 lbs.
COMPARTMENT:	-	15 1/2"	19 3/8"	15 3/8"	120 lbs.

10-DR CABINET	DRS.	WIDTH	DEPTH	HEIGHT	CAPACITY
DRAWERS:	1	39 1/2"	18 1/2"	6"	120 lbs.
	2	25"	18 1/2"	2"	120 lbs.
	3	25"	18 1/2"	4"	120 lbs.
	3	12"	18 1/2"	2"	120 lbs.
	1	12"	18 1/2"	10"	120 lbs.

MASTER No.	ITEM DESCRIPTION	WIDTH	DEPTH	HEIGHT	NET WT	SHIP WT	CAPACITY
4405__	5-Drawer Chest	43 3/4"	20"	16 1/2"	123 lbs.	137 lbs.	9,723 cu. in.
4410__	10-Drawer Cabinet	43 3/4"	20"	37 3/4"	301 lbs.	316 lbs.	14,305 cu. in.



Pro-Line™ Kennedy

"Built to Work"—"Built to Last"

Product Features:



High Security Tubular Locking System



Rugged Roller Bearing Casters Carry Heavy Loads



Smooth Operating Ball-Bearing Drawer Slides Hold Up to 120 lbs Per Drawer



Tubular Steel Side Handles

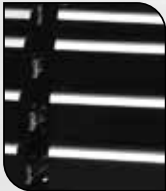

Full-Width, Aluminum Drawer Pulls



MDF Work Surface



Pro-Line Series Maintenance Carts come Standard in black powdercoat paint finish. Simply place 'BK' at the end of the model number. Additional colors require extra lead time.

METAL THICKNESS	
Frame	18 ga
Drawers	20 ga

39" PRO-LINE™ SERIES TOP CANOPY

- Fits 39" Wide Pro-Line™ Models
- Gas Shock Lid Stays
- MDF Work Surface Included
- Includes 10-pc Toolholder Set #99851
- Metal Thickness: Body - 18 ga. Drawers - 20 ga.

MASTER No.	ITEM DESCRIPTION	WIDTH	DEPTH	HEIGHT	NET WT	SHIP WT	CAPACITY
10490	39" Top Canopy	39"	18"	20"	69 lbs.	74 lbs.	12,200 cu. in.

PRO-LINE™ SERIES 7-DRAWER MAINTENANCE CART

- Storage Compartment with MDF Shelf & Work Surface
- Ball-Bearing Drawer Slides in Every Drawer
- High Security Tubular Locking System
- 5" x 2" Roller Bearing Casters Hold Up to 350 lbs. Each
- Metal Thickness: Body - 18 ga. Drawers - 20 ga.

7-DR CART	DRS.	WIDTH	DEPTH	HEIGHT	CAPACITY
DRAWERS:	3	23"	16 1/2"	2"	120 lbs.
	3	23"	16 1/2"	4"	120 lbs.
	1	23"	16 1/2"	6"	120 lbs.
COMPARTMENT:	-	10 3/4"	18"	28"	120 lbs.

MASTER No.	ITEM DESCRIPTION	WIDTH	DEPTH	HEIGHT	NET WT	SHIP WT	CAPACITY
10491	7-Drawer Cart	39 3/8"	18"	35 1/8"	175 lbs.	205 lbs.	13,865 cu. in.

PRO-LINE™ SERIES 12-DRAWER MAINTENANCE CARTS

- MDF Work Surface & Wide Top Drawer for Added Storage
- Metal Thickness: Body - 18 ga. Drawers - 20 ga.
- Model 10493 - 5" x 2" Roller Bearing Casters Hold Up to 350 lbs. Each
- Model 10495 - 6" x 2" Roller Bearing Casters Hold Up to 700 lbs. Each

MODEL: 10493	DRS.	WIDTH	DEPTH	HEIGHT	CAPACITY
DRAWERS:	1	35 3/4"	16 1/2"	6"	120 lbs.
	2	23"	16 1/2"	2"	120 lbs.
	3	23"	16 1/2"	4"	120 lbs.
	1	23"	16 1/2"	6"	120 lbs.
	2	9 3/4"	16 1/2"	2"	120 lbs.
	2	9 3/4"	16 1/2"	4"	120 lbs.
1	9 3/4"	16 1/2"	10"	120 lbs.	

MODEL: 10495	DRS.	WIDTH	DEPTH	HEIGHT	CAPACITY
DRAWERS:	1	37 3/4"	18 1/2"	6"	120 lbs.
	2	25"	18 1/2"	2"	120 lbs.
	3	25"	18 1/2"	4"	120 lbs.
	1	25"	18 1/2"	6"	120 lbs.
	2	9 3/4"	18 1/2"	2"	120 lbs.
	2	9 3/4"	18 1/2"	4"	120 lbs.
	1	9 3/4"	18 1/2"	10"	120 lbs.

MASTER No.	ITEM DESCRIPTION	WIDTH	DEPTH	HEIGHT	NET WT	SHIP WT	CAPACITY
10493	12-Drawer Cart	39 3/8"	18"	39 1/8"	225 lbs.	255 lbs.	13,365 cu. in.
10495	12-Drawer Cart	41 3/8"	20"	42"	250 lbs.	280 lbs.	16,686 cu. in.

PRO-LINE™ SERIES 13-DRAWER MAINTENANCE CARTS

- MDF Work Surface Included on Both Models
- Metal Thickness: Body - 18 ga. Drawers - 20 ga.
- Model 10492 - 5" x 2" Roller Bearing Casters Hold Up to 350 lbs. Each
- Model 10494 - 6" x 2" Roller Bearing Casters Hold Up to 700 lbs. Each

MODEL: 10492	DRS.	WIDTH	DEPTH	HEIGHT	CAPACITY
DRAWERS:	1	23"	16 1/2"	2"	120 lbs.
	5	23"	16 1/2"	4"	120 lbs.
	1	23"	16 1/2"	6"	120 lbs.
	1	9 3/4"	16 1/2"	2"	120 lbs.
	4	9 3/4"	16 1/2"	4"	120 lbs.
	1	9 3/4"	16 1/2"	10"	120 lbs.

MODEL: 10494	DRS.	WIDTH	DEPTH	HEIGHT	CAPACITY
DRAWERS:	1	25"	18 1/2"	2"	120 lbs.
	5	25"	18 1/2"	4"	120 lbs.
	1	25"	18 1/2"	6"	120 lbs.
	1	9 3/4"	18 1/2"	2"	120 lbs.
	4	9 3/4"	18 1/2"	4"	120 lbs.
	1	9 3/4"	18 1/2"	10"	120 lbs.

MASTER No.	ITEM DESCRIPTION	WIDTH	DEPTH	HEIGHT	NET WT	SHIP WT	CAPACITY
10492	13-Drawer Cart	39 3/8"	18"	39 1/8"	220 lbs.	250 lbs.	13,315 cu. in.
10494	13-Drawer Cart	41 3/8"	20"	42"	245 lbs.	275 lbs.	16,868 cu. in.



MECHANICS' & MACHINISTS' Chests and Bases

Mechanics' Chest & Base Product Features:



High Security Tubular Locking System With Two Keys



Heavy-Duty, Plated Side Handles



Locking Stays Hold Lid Open



Heavy-Duty Slides Hold Up to 80 lbs.



Model 266R:
6-Drawer Mechanics' Chest

Machinists' Chest & Base Special Product Features:



Two-Piece, Welded Friction Drawer Slides Add Strength & Hold up to 50 lbs. Per Drawer



Wool-Felt Lined Drawers Protect Precision Tools



Drop-Front Panel Conceals and Secures Drawers - Stores In Base When Not In Use



Model 526:
8-Drawer Machinists' Chest



All Mechanics' Chests & Bases come Standard in brown wrinkle or red powdercoat paint finish.



All Machinists' Chests & Bases come Standard in brown wrinkle powdercoat paint finish.

METAL THICKNESS	
Frame	20 ga
Drawers	22 ga

STANDARD MECHANICS' CHESTS*

- Models 263, 266, & 360 - Fit On 27" and 29" Wide Roller Cabinets
- Model 2812 - Fits On 29" and 34" Wide Roller Cabinets
- Lift-Out Tote Tray with Socket Set Divider Included

MODEL: 263	DRS.	WIDTH	DEPTH	HEIGHT	CAPACITY
TOP TILL:	-	26"	11 7/8"	4 1/8"	80 lbs.
TOTE TRAY:	-	19 1/2"	7 3/4"	3 3/8"	80 lbs.
DRAWERS:	1	23"	10 3/4"	2"	80 lbs.
	1	23"	10 3/4"	3"	80 lbs.
	1	23"	10 3/4"	4"	80 lbs.

MODEL: 266	DRS.	WIDTH	DEPTH	HEIGHT	CAPACITY
TOP TILL:	-	26"	11 7/8"	4 1/8"	80 lbs.
TOTE TRAY:	-	19 1/2"	7 3/4"	3 3/8"	80 lbs.
DRAWERS:	3	6 7/8"	10 3/4"	2"	80 lbs.
	2	22 7/8"	10 3/4"	2"	80 lbs.
	1	22 7/8"	10 3/4"	3"	80 lbs.

MODEL: 360	DRS.	WIDTH	DEPTH	HEIGHT	CAPACITY
TOP TILL:	-	26"	11 7/8"	4 1/8"	80 lbs.
TOTE TRAY:	-	19 1/2"	7 3/4"	3 3/8"	80 lbs.
DRAWERS:	1	6 7/8"	10 3/4"	6 1/4"	80 lbs.
	6	6 7/8"	10 3/4"	2"	80 lbs.
	2	22 7/8"	10 3/4"	2"	80 lbs.
	1	22 7/8"	10 3/4"	3"	80 lbs.

MODEL: 2812	DRS.	WIDTH	DEPTH	HEIGHT	CAPACITY
TOP TILL:	-	28 9/16"	12"	4 1/8"	80 lbs.
TOTE TRAY:	-	19 1/2"	7 3/4"	3 3/8"	80 lbs.
DRAWERS:	9	8 5/8"	10 3/4"	2"	80 lbs.
	2	25 1/2"	10 3/4"	2"	80 lbs.
	1	25 1/2"	10 3/4"	3"	80 lbs.

MASTER No.	ITEM DESCRIPTION	WIDTH	DEPTH	HEIGHT	NET WT	SHIP WT	CAPACITY
263	3-Drawer Chest	26 1/8"	12 1/8"	14 3/4"	44 lbs.	50 lbs.	3,314 cu. in.
266	6-Drawer Chest	26 1/8"	12 1/8"	14 3/4"	52 lbs.	58 lbs.	3,178 cu. in.
360	10-Drawer Chest	26 1/8"	12 1/8"	18 7/8"	68 lbs.	75 lbs.	3,996 cu. in.
2812	12-Drawer Chest	28 3/8"	12 1/8"	18 7/8"	71 lbs.	78 lbs.	4,366 cu. in.

* Includes Welded Slides in all Drawers



MECHANICS' CHEST BASES*

- Use With All Mechanics' Chests and 27", 29", & 34" Roller Cabinets
- Model 2902 - Fits Model 2812 and 29" or 34" Roller Cabinets Only

MODEL: 2602	DRS.	WIDTH	DEPTH	HEIGHT	CAPACITY
DRAWERS:	2	22 7/8"	10 3/4"	4"	80 lbs.

MODEL: 2603	DRS.	WIDTH	DEPTH	HEIGHT	CAPACITY
DRAWERS:	2	22 7/8"	10 3/4"	2"	80 lbs.
	1	22 7/8"	10 3/4"	4"	80 lbs.

MODEL: 2604	DRS.	WIDTH	DEPTH	HEIGHT	CAPACITY
DRAWERS:	4	22 7/8"	10 3/4"	2"	80 lbs.

MODEL: 2902	DRS.	WIDTH	DEPTH	HEIGHT	CAPACITY
DRAWERS:	2	24 7/8"	10 3/4"	80 lbs.	

MASTER No.	ITEM DESCRIPTION	WIDTH	DEPTH	HEIGHT	NET WT	SHIP WT	CAPACITY
2602	2-Drawer Chest Base	26 5/8"	12 1/2"	11 3/4"	30 lbs.	40 lbs.	1,888 cu. in.
2603	3-Drawer Chest Base	26 5/8"	12 1/2"	11 3/4"	33 lbs.	43 lbs.	1,795 cu. in.
2604	4-Drawer Chest Base	26 3/4"	12 1/2"	11 3/4"	35 lbs.	45 lbs.	1,703 cu. in.
2902	2-Drawer Chest Base	28 3/4"	12 1/2"	11 3/4"	36 lbs.	46 lbs.	2,047 cu. in.
2600	Chest Riser	26 5/8"	12 1/2"	11 3/4"	9 lbs.	19 lbs.	3,660 cu. in.

* Includes Welded Slides in all Drawers



SNAP-IN MECHANICS' CHESTS

- Snap-In Slides Hold Up To 80 lbs. Per Drawer
- Models 2705X & 285(X) Fit 27" Wide Roller Cabinets
- Models 2905X & 2805(X) Fit 29" or 34" Wide Roller Cabinets

MODEL: 2705X	DRS.	WIDTH	DEPTH	HEIGHT	CAPACITY
TOP TILL:	-	26 7/8"	17 3/4"	3 5/8"	80 lbs.
DRAWERS:	4	23"	16 1/2"	2"	80 lbs.
	1	23"	16 1/2"	4"	80 lbs.

MODEL: 2905X	DRS.	WIDTH	DEPTH	HEIGHT	CAPACITY
TOP TILL:	-	28 7/8"	19 3/4"	3 5/8"	80 lbs.
DRAWERS:	4	25"	18 1/2"	2"	80 lbs.
	1	25"	18 1/2"	4"	80 lbs.

MODEL: 285	DRS.	WIDTH	DEPTH	HEIGHT	CAPACITY
DRAWERS:	4	23"	16 1/2"	2"	80 lbs.
	1	23"	16 1/2"	4"	80 lbs.



Continued on next page..

MODEL: 285X	DRS.	WIDTH	DEPTH	HEIGHT	CAPACITY
DRAWERS:	4	23"	16 1/2"	2"	120 lbs.
	1	23"	16 1/2"	4"	120 lbs.

MODEL: 2805	DRS.	WIDTH	DEPTH	HEIGHT	CAPACITY
DRAWERS:	4	25"	18 1/2"	2"	120 lbs.
	1	25"	18 1/2"	4"	120 lbs.

MODEL: 2805X	DRS.	WIDTH	DEPTH	HEIGHT	CAPACITY
DRAWERS:	4	25"	18 1/2"	2"	120 lbs.
	1	25"	18 1/2"	4"	120 lbs.

MASTER No.	ITEM DESCRIPTION	WIDTH	DEPTH	HEIGHT	NET WT	SHIP WT	CAPACITY
2705X	27" 5-Drawer Chest	27"	18"	18 3/8"	88 lbs.	96 lbs.	5,842 cu. in.
2905X	29" 5-Drawer Chest	29"	20"	18 3/8"	100 lbs.	109 lbs.	7,077 cu. in.
285	27" 5-Drawer Chest	27"	18"	16 3/8"	75 lbs.	84 lbs.	4,000 cu. in.
285X	27" 5-Drawer Chest	27"	18"	16 5/8"	80 lbs.	89 lbs.	4,000 cu. in.
2805	29" 5-Drawer Chest	29"	20"	16 3/8"	87 lbs.	96 lbs.	4,872 cu. in.
2805X	29" 5-Drawer Chest	29"	20"	16 5/8"	92 lbs.	101 lbs.	4,872 cu. in.



MACHINISTS' CHESTS & BASES*

- Models 620 and 520 - Come With Vinyl Cushioned, Steel Top Handle
- Models 526, 52611, & 3611 - Include Steel Side Handles

MODEL: 620	DRS.	WIDTH	DEPTH	HEIGHT	CAPACITY
TOP TILL:	-	20"	8 3/8"	4 1/2"	90 lbs.
DRAWERS:	1	18 1/4"	7 1/2"	1 1/2"	90 lbs.
	1	18 1/4"	7 1/2"	2 1/4"	90 lbs.
	1	18 1/4"	7 1/2"	3 1/8"	90 lbs.

MODEL: 520	DRS.	WIDTH	DEPTH	HEIGHT	CAPACITY
TOP TILL:	-	20"	8 3/8"	4 1/2"	90 lbs.
DRAWERS:	4	8 5/8"	7 1/2"	1"	90 lbs.
	1	8 5/8"	7 1/2"	2"	90 lbs.
	1	18 1/4"	7 1/2"	1 1/2"	90 lbs.
	1	18 1/4"	7 1/2"	2 1/4"	90 lbs.

MODEL: 526	DRS.	WIDTH	DEPTH	HEIGHT	CAPACITY
TOP TILL:	-	26 1/2"	8 3/8"	4 1/2"	90 lbs.
DRAWERS:	HB	5 1/2"	7 1/2"	5 1/2"	90 lbs.
	4	8 5/8"	7 1/2"	1"	90 lbs.
	1	8 5/8"	7 1/2"	2"	90 lbs.
	1	24 3/4"	7 1/2"	1 1/2"	90 lbs.
	1	24 3/4"	7 1/2"	2 1/4"	90 lbs.

MODEL: 52611	DRS.	WIDTH	DEPTH	HEIGHT	CAPACITY
TOP TILL:	-	26 1/2"	8 3/8"	4 1/2"	90 lbs.
DRAWERS:	HB	5 1/2"	7 1/2"	4 3/8"	90 lbs.
	6	8 5/8"	7 1/2"	1"	90 lbs.
	1	8 5/8"	7 1/2"	2"	90 lbs.
	1	24 3/4"	7 1/2"	1 1/2"	90 lbs.
	1	24 3/4"	7 1/2"	2 1/4"	90 lbs.
	1	24 3/4"	7 1/2"	3 1/8"	90 lbs.

MODEL: 3611	DRS.	WIDTH	DEPTH	HEIGHT	CAPACITY
TOP TILL:	-	26"	12 1/8"	4 1/2"	90 lbs.
DRAWERS:	HB	5 1/2"	10 7/8"	5 1/2"	90 lbs.
	6	7 5/8"	10 7/8"	1 1/4"	90 lbs.
	1	7 5/8"	10 7/8"	2 5/8"	90 lbs.
	2	23"	10 7/8"	2"	90 lbs.
	1	23"	10 7/8"	3"	90 lbs.

MODEL: 5150	DRS.	WIDTH	DEPTH	HEIGHT	CAPACITY
DRAWERS:	1	24 1/8"	10 7/8"	2"	90 lbs.
	1	24 1/8"	10 7/8"	4 1/8"	90 lbs.

MODEL: MC22	DRS.	WIDTH	DEPTH	HEIGHT	CAPACITY
DRAWERS:	1	18"	9 3/8"	1 1/2"	90 lbs.
	1	18"	9 3/8"	3 1/2"	90 lbs.

MODEL: MC28	DRS.	WIDTH	DEPTH	HEIGHT	CAPACITY
DRAWERS:	1	24 1/2"	9 3/8"	1 1/2"	90 lbs.
	1	24 1/2"	9 3/8"	3 1/2"	90 lbs.

MASTER No.	ITEM DESCRIPTION	WIDTH	DEPTH	HEIGHT	NET WT	SHIP WT	CAPACITY
620	3-Drawer Chest	20 1/8"	8 1/2"	13 5/8"	25 lbs.	32 lbs.	1,800 cu. in.
520	7-Drawer Chest	20 1/8"	8 1/2"	13 5/8"	28 lbs.	35 lbs.	1,694 cu. in.
526	8-Drawer Chest	26 3/4"	8 1/2"	13 5/8"	36 lbs.	44 lbs.	2,219 cu. in.
52611	11-Drawer Chest	26 3/4"	8 1/2"	18"	47 lbs.	56 lbs.	3,000 cu. in.
3611	11-Drawer Chest	26 1/8"	12 1/8"	18 7/8"	69 lbs.	75 lbs.	3,976 cu. in.
5150	2-Drawer Base	26 3/4"	12 1/2"	9 1/2"	28 lbs.	37 lbs.	1,200 cu. in.
MC22	2-Drawer Base	21 5/8"	9 5/8"	7 7/8"	17 lbs.	19 lbs.	865 cu. in.
MC28	2-Drawer Base	28 1/8"	9 5/8"	7 7/8"	21 lbs.	23 lbs.	1,179 cu. in.



Model 620
4 Adjustable Dividers



Model 520
6 Adjustable Dividers



Model 526
6 Adjustable Dividers



Model 52611
8 Adjustable Dividers



Model 3611
6 Adjustable Dividers



Model 5150
Supports: 526, 52611, & 3611



Model MC22
Supports: 620 & 520



Model MC28
Supports: 526, 52611, & 3611

* Includes Welded Slides in all Drawers

HAND CARRY TOOLBOXES

Product Features:



Vinyl Cushioned, Steel Core Top Handle



High-Quality, Plated Locking Hardware



Steel Tote Trays With Socket Set Divider (Select Models Only)



22" CANTILEVER TOOL BOX

- Create up to six compartments in each of two trays with movable/removable partitions and divider sets.
- One tray has divider for storing sockets.
- Quality plated locking hardware and steel core, vinyl cushioned handle.

20" PROFESSIONAL TOOL BOX

- Includes lift-out tray with socket set divider.
- Quality plated locking hardware and steel core, vinyl cushioned handle.



24" PROFESSIONAL TOOL BOX

- Includes lift-out tray with socket set divider.
- Quality plated locking hardware and steel core, vinyl cushioned handle.



20" ALL-PURPOSE TOOL BOX

- Includes lift-out tray.
- Quality plated locking hardware and steel core, vinyl cushioned handle.

METAL THICKNESS	
Frame	20 ga
Drawers	22 ga

MODEL:	1022	TRAY	WIDTH	DEPTH	HEIGHT	CAPACITY
TRAYS:	4	20 1/2"	4 3/8"	1 1/2"	80 lbs.	
MODEL:	K20	TRAY	WIDTH	DEPTH	HEIGHT	CAPACITY
TRAYS:	1	19 1/2"	7 3/4"	3 3/8"	80 lbs.	
MODEL:	K24	TRAY	WIDTH	DEPTH	HEIGHT	CAPACITY
TRAYS:	1	23 1/2"	7 3/4"	3 3/8"	80 lbs.	
MODEL:	5220	TRAY	WIDTH	DEPTH	HEIGHT	CAPACITY
TRAYS:	1	19 7/8"	6 3/8"	4"	80 lbs.	
MODEL:	220	DRS.	WIDTH	DEPTH	HEIGHT	CAPACITY
TOP TILL:	-	20"	8 3/8"	4 1/8"	80 lbs.	
DRAWERS:	2	18 1/8"	7 3/8"	2 1/4"	80 lbs.	



24" PROFESSIONAL TOOL BOX

- A tool chest that can be used as stationary storage on your work bench or can be carried to the job.
- Includes standard lock and two keys.
- Vinyl cushioned top carry handle.
- Available in brown wrinkle (B) or smooth red finish (R)

MASTER No.	ITEM DESCRIPTION	WIDTH	DEPTH	HEIGHT	NET WT	SHIP WT	CAPACITY
1022	22" Cantilever Tool Box	22 1/8"	10"	12 3/8"	18.3 lbs.	19.5 lbs.	1,927 cu. in.
K20	20" Pro Tool Box	20 1/8"	8 5/8"	9 3/4"	13 lbs.	14 lbs.	1,636 cu. in.
K24	24" Pro Tool Box	24 1/8"	8 5/8"	9 3/4"	14.5 lbs.	16 lbs.	1,963 cu. in.
5220	20" All-Purpose Tool Box	20 1/8"	7 1/8"	7 1/4"	9 lbs.	10 lbs.	1,000 cu. in.
220	2-Drawer Chest	20 1/8"	8 5/8"	9 3/4"	17 lbs.	19 lbs.	1,293 cu. in.



All Machinists' Chests & Bases come Standard in brown wrinkle powdercoat paint finish.

VERSA-BENCH®

Product Features:



1/8" Steel Work Surface



Heavy-Duty, Plated Side Handles



8" x 2" Casters w/
Phenolic Wheels
(900 lbs. Capacity Each)



Standard Floor Lock
Included



Stationary Leg Sets Available
For 48" and 60" Models
(Sold Separately)



Maple Wood Work Surface
Protects Your Versa-Bench
(Sold Separately)



Model 4804:
4 Drawer Versa-Bench®



Model 4806:
6 Drawer Versa-Bench®



Customize the color of your products. Simply place one of the abbreviations at the end of the model number.

METAL THICKNESS	
Frame	11 ga
Drawers	11 ga

48" 4-DRAWER VERSA-BENCH®

- Padlockable Doors For Added Security.
- Two Open Shelves On Back Allow Fast And Easy Tool Access.
- Two Additional Casters (6 Total) Can Be Added for Up To 5,400 lbs. Capacity
- NOTE: 2 ¼" Lip Height For a Total Product Height of 38 ½"

MODEL: 4804	DRS.	WIDTH	DEPTH	HEIGHT	CAPACITY
DRAWERS:	2	23"	16 ½"	2"	120 lbs.
	2	23"	16 ½"	4"	120 lbs.
TOP FRONT COMPARTMENT:	20 ¾"	19 ¾"	14 ¼"	120 lbs.	
BOTTOM FRONT COMPARTMENT:	48"	19 ¾"	11 ½"	120 lbs.	
BACK OPEN SHELVES:	48"	5 ⅞"	13"	120 lbs.	

MASTER No.	ITEM DESCRIPTION	WIDTH	DEPTH	HEIGHT	NET WT	SHIP WT	CAPACITY
4804	4-Drawer Versa-Bench	48 ⅞"	26"	35 ⅞"	345 lbs.	375 lbs.	26,488 cu. in.



48" 6-DRAWER VERSA-BENCH®

- Lock And Two Keys, Plus Padlockable Doors For Added Security
- Two Open Shelves On Back Allow Fast And Easy Tool Access.
- Two Additional Casters (6 Total) Can Be Added for Up To 5,400 lbs. Capacity
- NOTE: 2 ¼" Lip Height For a Total Product Height of 38 ½"

MODEL: 4806	DRS.	WIDTH	DEPTH	HEIGHT	CAPACITY
DRAWERS:	3	23"	16 ½"	2"	120 lbs.
	2	23"	16 ½"	4"	120 lbs.
	1	23"	16 ½"	5"	120 lbs.
TOP FRONT COMPARTMENT:	17 ½"	19 ¾"	14 ¼"	120 lbs.	
BOTTOM FRONT COMPARTMENT:	17 ½"	19 ¾"	11 ½"	120 lbs.	
BACK OPEN SHELVES:	48"	5 ⅞"	13"	120 lbs.	

MASTER No.	ITEM DESCRIPTION	WIDTH	DEPTH	HEIGHT	NET WT	SHIP WT	CAPACITY
4806	6-Drawer Versa-Bench	48 ⅞"	26"	35 ⅞"	395 lbs.	425 lbs.	21,948 cu. in.



48" 10-DRAWER VERSA-BENCH®

- Padlockable Doors For Added Security
- Two Additional Casters (6 Total) Can Be Added for Up To 5,400 lbs. Capacity (See Accessory Section For Further Details)
- NOTE: 2 ¼" Lip Height For a Total Product Height of 38 ½"

MODEL: 4810	DRS.	WIDTH	DEPTH	HEIGHT	CAPACITY
DRAWERS:	2	29 ¾"	23 ½"	2"	120 lbs.
	3	29 ¾"	23 ½"	4"	120 lbs.
	3	12"	23 ½"	2"	120 lbs.
	1	12"	23 ½"	10"	120 lbs.
	1	44"	23 ½"	5 ⅞"	120 lbs.

MASTER No.	ITEM DESCRIPTION	WIDTH	DEPTH	HEIGHT	NET WT	SHIP WT	CAPACITY
4810	10-Drawer Versa-Bench	48 ⅞"	26"	35 ⅞"	500 lbs.	530 lbs.	19,989 cu. in.



27" 6-DRAWER REPLACEMENT BENCH CABINET

- High Security Tubular Locking System & Keys
- Ball-Bearing Slides On All Drawers

MODEL: 286X	DRS.	WIDTH	DEPTH	HEIGHT	CAPACITY
DRAWERS:	3	23"	16 ½"	2"	120 lbs.
	2	23"	16 ½"	4"	120 lbs.
	1	23"	16 ½"	5"	120 lbs.

MASTER No.	ITEM DESCRIPTION	WIDTH	DEPTH	HEIGHT	NET WT	SHIP WT	CAPACITY
286X	6-Drawer Cabinet	27"	18"	23 ⅝"	102 lbs.	112 lbs.	6,821 cu. in.



STATIONARY LEG SET

- Replace Bench Casters With Stationary, Steel Formed Legs
- Mounts Using The Same Holes As The Casters

MASTER No.	ITEM DESCRIPTION	WIDTH	DEPTH	HEIGHT	NET WT	SHIP WT	CAPACITY
VBLEG	Stationary Legs	-	-	9 ¼"	10 lbs.	14 lbs.	900 lbs. Each



VERSA-BENCH® CASTER SET

- 8" x 2" Roller Bearing Casters with Phenolic Wheels
- Two Swivel Casters Per Set
- For All Versa-Bench Models

MASTER No.	ITEM DESCRIPTION	DIA.	WIDTH	OVERALL	NET WT	SHIP WT	CAPACITY
80838	8" x 2" Caster Set	8"	2"	9 ½"	15 lbs.	19 lbs.	900 lbs. Each



MAPLE WORK SURFACE

- 1 1/2" Maple Top Has Full-Length Laminations Specially Selected for Grain And Color Match
- Comes With Wood Screws, Template, and Easy-To-Read Installation Instructions
- **Model WT48** - Fits 48" Versa-Benches
- **Model WT60** - Fits 60" Versa-Benches



MASTER No.	ITEM DESCRIPTION	WIDTH	DEPTH	HEIGHT	NET WT	SHIP WT	CAPACITY
WT48	Maple Work Surface	47 7/8"	25 7/8"	1 1/2"	45 lbs.	50 lbs.	-
WT60	Maple Work Surface	60 3/8"	32"	1 1/2"	75 lbs.	80 lbs.	-

60" 6-DRAWER VERSA-BENCH®

- Includes a 6-Drawer Cabinet Equipped With Lock and Two Keys
- Features an Open Compartment Behind the Cabinet
- Pad-Lockable Rear Doors Cover 2-Shelf Storage Space



MODEL: 6006	DRS.	WIDTH	DEPTH	HEIGHT	CAPACITY
DRAWERS:	3	23"	16 1/2"	2"	120 lbs.
	2	23"	16 1/2"	4"	120 lbs.
	1	23"	16 1/2"	5"	120 lbs.
TOP FRONT COMPARTMENT:		27 1/4"	30 1/8"	11 5/8"	120 lbs.
BOTTOM FRONT COMPARTMENT:		27 1/4"	30 1/8"	14 1/8"	120 lbs.
BACK OPEN COMPARTMENT:		29 1/4"	9 1/2"	26"	120 lbs.

MASTER No.	ITEM DESCRIPTION	WIDTH	DEPTH	HEIGHT	NET WT	SHIP WT	CAPACITY
6006	6-Drawer Versa-Bench	60 3/8"	32"	35 7/8"	450 lbs.	475 lbs.	35,297 cu. in.

60" 12-DRAWER VERSA-BENCH®

- Includes two 6-Drawer Cabinets Equipped With Lock and Two Keys
- Features a Rear Compartment for Storing Extra-Large Tools
- Pad-Lockable Rear Doors Cover 2-Shelf Storage Space



Back View
Models: 6006, 6012S

MODEL: 6012S	DRS.	WIDTH	DEPTH	HEIGHT	CAPACITY
DRAWERS:	6	23"	16 1/2"	2"	120 lbs.
	4	23"	16 1/2"	4"	120 lbs.
	2	23"	16 1/2"	5"	120 lbs.
TOP BACK COMPARTMENT:		27 1/4"	10 7/8"	14 1/2"	120 lbs.
BOTTOM BACK COMPARTMENT:		27 1/4"	10 7/8"	11 3/8"	120 lbs.
BACK OPEN COMPARTMENT:		29 1/4"	9 1/2"	26"	120 lbs.

MASTER No.	ITEM DESCRIPTION	WIDTH	DEPTH	HEIGHT	NET WT	SHIP WT	CAPACITY
6012S	12-Drawer Versa-Bench	60 3/8"	32"	35 7/8"	500 lbs.	525 lbs.	28,547 cu. in.



60" 12-DRAWER VERSA-BENCH®

- Includes two 6-Drawer Cabinets Equipped With Lock and Two Keys
- Side Openings Have Shelves and Doors That Can Be Pad-Locked for Extra Security

MODEL: 6012E	DRS.	WIDTH	DEPTH	HEIGHT	CAPACITY
DRAWERS:	6	23"	16 1/2"	2"	120 lbs.
	4	23"	16 1/2"	4"	120 lbs.
	2	23"	16 1/2"	5"	120 lbs.
TOP COMPARTMENT:		20"	30 1/8"	11 1/2"	120 lbs.
BOTTOM COMPARTMENT:		20"	30 1/8"	14 1/8"	120 lbs.

MASTER No.	ITEM DESCRIPTION	WIDTH	DEPTH	HEIGHT	NET WT	SHIP WT	CAPACITY
6012E	12-Drawer Versa-Bench	60 7/8"	32"	35 7/8"	500 lbs.	530 lbs.	29,154 cu. in.



54" INDUSTRIAL WORK BENCHES w/ MAPLE TOP

- Maple Work Surface is Made of Quality 1 1/2"-Thick Butcher Block with Full-Grain Laminations
- 5-Drawer Unit Features 2 Deep Shelves to Neatly Organize Tools
- Adjustable Legs For Leveling, Even On the Roughest Floors
- Some Assembly Required on 54" & 26" Models
- Metal Thickness: Body - 20 ga. Drawers - 22 ga.

MODEL: W5405X DRS.	WIDTH	DEPTH	HEIGHT	CAPACITY	
DRAWERS:	5	17 1/2"	16 1/2"	4"	120 lbs.
SHELVES:	2	17 3/8"	17 1/2"	-	120 lbs.

MODEL: W5410X DRS.	WIDTH	DEPTH	HEIGHT	CAPACITY	
DRAWERS:	10	17 1/2"	16 1/2"	4"	120 lbs.

MASTER No.	ITEM DESCRIPTION	WIDTH	DEPTH	HEIGHT	NET WT	SHIP WT	CAPACITY
W5405X	5-Drawer Work Station	54"	20"	34 1/2"	137 lbs.	157 lbs.	16,261 cu. in.
W5410X	10-Drawer Work Station	54"	20"	34 1/2"	187 lbs.	222 lbs.	11,550 cu. in.



54" INDUSTRIAL WORK BENCHES w/ STEEL TOP

- Durable, 12 Gauge Steel Work Surface and Ball-Bearing Slides in All Drawers
- 5-Drawer Unit Features 2 Deep Shelves to Neatly Organize Tools
- Adjustable Legs For Leveling, Even On the Roughest Floors
- Some Assembly Required on 54" & 26" Models
- Metal Thickness: Body - 20 ga. Drawers - 22 ga.

MODEL: S5405X DRS.	WIDTH	DEPTH	HEIGHT	CAPACITY	
DRAWERS:	5	17 1/2"	16 1/2"	4"	120 lbs.
SHELVES:	2	17 3/8"	17 1/2"	-	120 lbs.

MODEL: S5410X DRS.	WIDTH	DEPTH	HEIGHT	CAPACITY	
DRAWERS:	10	17 1/2"	16 1/2"	4"	120 lbs.

MASTER No.	ITEM DESCRIPTION	WIDTH	DEPTH	HEIGHT	NET WT	SHIP WT	CAPACITY
S5405X	5-Drawer Work Station	54"	20"	34 1/2"	144 lbs.	161 lbs.	16,261 cu. in.
S5410X	10-Drawer Work Station	54"	20"	33 3/4"	196 lbs.	219 lbs.	11,550 cu. in.



1 & 5-DRAWER HEAVY DUTY TOOL STANDS

- Comes With Ball-Bearing Drawer Slides
- One-Inch Thick Press Board Work Surface

MODEL: TS261X DRS.	WIDTH	DEPTH	HEIGHT	CAPACITY	
DRAWERS:	1	17 1/2"	16 1/2"	4"	120 lbs.
SHELF:	1	17 3/8"	17 1/2"	-	120 lbs.

MODEL: TS265X DRS.	WIDTH	DEPTH	HEIGHT	CAPACITY	
DRAWERS:	5	17 1/2"	16 1/2"	4"	120 lbs.

MASTER No.	ITEM DESCRIPTION	WIDTH	DEPTH	HEIGHT	NET WT	SHIP WT	CAPACITY
TS261X	1-Drawer Tool Stand	26"	20"	33 1/2"	62 lbs.	71 lbs.	6,090 cu. in.
TS265X	5-Drawer Tool Stand	26"	20"	33 1/2"	95 lbs.	108 lbs.	5,775 cu. in.



WALL STORAGE CABINET

- Mounting Holes Spaced 16" Apart for Easy Fastening to Wall Studs (Hardware Included)
- Two Adjustable Shelves for Storing Cans of Paint or Lubricants
- Perforated Panels on Inside of Pad-Lockable Doors

MODEL: WC28 DRS.	WIDTH	DEPTH	HEIGHT	CAPACITY	
SHELVES:	2	28"	3 3/4"	-	80 lbs.

MASTER No.	ITEM DESCRIPTION	WIDTH	DEPTH	HEIGHT	NET WT	SHIP WT	CAPACITY
WC28	Wall Storage Cabinet	28 1/8"	9 5/8"	30"	40 lbs.	46 lbs.	7,288 cu. in.



4 & 5 DRAWER PACKAGES

- DR264X - 4 Drawer Package Adds Extra Storage to 26" One-Drawer Tool Stand.
- DR265X - 5 Drawer Package Adds Extra Storage to Any 54" Work Station.
- Slides and Applicable Hardware Included in Both Packages

MASTER No.	ITEM DESCRIPTION	WIDTH	DEPTH	HEIGHT	NET WT	SHIP WT	CAPACITY
DR264X	4-Drawer Package	17 7/8"	17 7/8"	16 1/2"	33 lbs.	37 lbs.	4,020 cu. in.
DR265X	5-Drawer Package	17 7/8"	17 7/8"	20 1/2"	52 lbs.	59 lbs.	3,775 cu. in.



WORK STATION SECURITY DOOR

- Includes Security Door, Mounting Hardware, and Locking Clip
- Can Be Mounted For Either Left or Right Opening
- Pad-Lockable Design (Lock Not Included)

MASTER No.	ITEM DESCRIPTION	WIDTH	DEPTH	HEIGHT	NET WT	SHIP WT	CAPACITY
DO26	Security Door	19 3/4"	5/8"	20 7/8"	10 lbs.	12 lbs.	-



All work stations come standard in gray wrinkle powdercoat paint finish.

STEEL TOOLBOARD SYSTEMS

Toolboard Panels provide quick, visual and safe access to tools, parts, accessories, supplies or bins. Can be mounted quickly and easily on any wall and in any panel configuration. Panels are 18" x 36" and are made of 18 gauge reinforced steel.

Product Features:



Reinforced Steel Panels With Square Perforations. Can Be Attached To A Variety Of Surfaces (Fasteners Not Included)



MCM Locking Clips Fasten Toolholders To Panels & Are Quick And Easy To Remove



Toolholder Accessories Hook Easily Onto Panels And Can Be Secured With Locking Clips (Sold Separate)



Hooks, Clips, And Other Accessories Are Industrial Grade Zinc-Plated Steel



Durable Toolboard Storage Bags Also Available



Mobile Packages Also Available (Select Models Only)

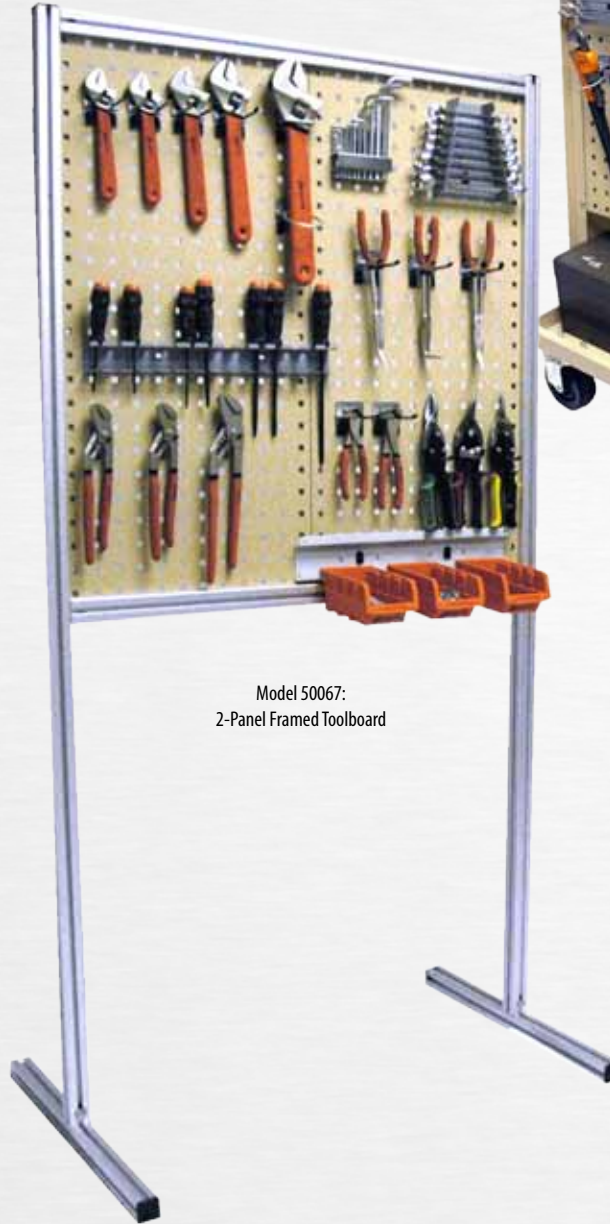

Model 50067:
2-Panel Framed Toolboard



Model 50102:
Open Tool Trolley



Customize the color of your products. Simply place one of the abbreviations at the end of the model number.

METAL THICKNESS	
Panels	18 ga

2-PANEL STEEL TOOLBOARD SET

- Includes Two 18" x 36" Steel Toolboard Panels
- Set Covers 9 sq.ft. Of Wall Space
- Customize Your Needs By Ordering Hooks And/Or Hook Sets



MASTER No.	ITEM DESCRIPTION	WIDTH	DEPTH	HEIGHT	NET WT	SHIP WT	CAPACITY
50002	2-Panel Toolboard Set	18"	1/2"	36"	13 lbs.	16 lbs.	60 lbs.

4-PANEL STEEL TOOLBOARD SET

- Consists Of Four 18" x 36" Steel Toolboard Panels
- Set Covers 18 sq.ft. Of Wall Space
- Includes 60-Piece Toolholder Set (99853)

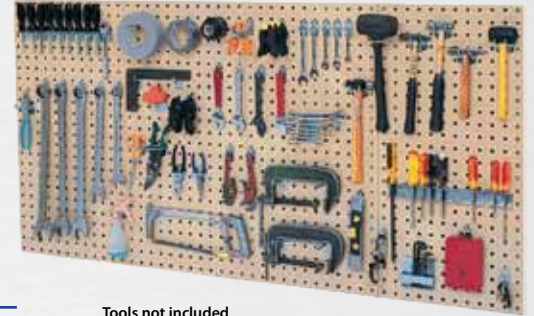

Tools not included

MASTER No.	ITEM DESCRIPTION	WIDTH	DEPTH	HEIGHT	NET WT	SHIP WT	CAPACITY
50004	4-Panel Toolboard Set	18"	1/2"	36"	32 lbs.	37 lbs.	120 lbs.

OPEN TOOLBOARD TROLLEY BASE

- Trolley Base Will Accommodate Two Sets (4 Panels) Of Toolboard Panels (Purchased Separately).
- Includes Mounted End Handle And Four 5 x 1 1/4" Casters
- Raised Edges Around Base For Easy Storage Of Larger Items



MASTER No.	ITEM DESCRIPTION	WIDTH	DEPTH	HEIGHT	NET WT	SHIP WT	CAPACITY
50100	Open Tool Trolley Base	36 3/4"	23 7/8"	51 7/8"	40 lbs.	48 lbs.	400 lbs.

OPEN TOOL TROLLEY

- Comes With Four 18" x 36" Steel Toolboard Panels
- Includes Mounted End Handle And Four 5 x 1 1/4" Casters
- Raised Edges Around Base For Easy Storage Of Larger Items
- Panels Mount To Base At An Incline, Ensuring Tools Are Safely Stowed
- Customize By Ordering Hooks And/Or Hook Accessory Sets (Sold Separate)



MASTER No.	ITEM DESCRIPTION	WIDTH	DEPTH	HEIGHT	NET WT	SHIP WT	CAPACITY
50104	Open Tool Trolley	36 3/4"	23 7/8"	51 7/8"	78 lbs.	88 lbs.	400 lbs.

OPEN TOOL TROLLEY & TOOLHOLDER SET

- Comes With Four 18" x 36" Steel Toolboard Panels
- Includes Mounted End Handle And Four 5 x 1 1/4" Casters
- Raised Edges Around Base For Easy Storage Of Larger Items
- Panels Mount To Base At An Incline, Ensuring Tools Are Safely Stowed
- Includes 60-Piece Toolholder Set (99853)



Tools not included

MASTER No.	ITEM DESCRIPTION	WIDTH	DEPTH	HEIGHT	NET WT	SHIP WT	CAPACITY
50102	Tool Trolley & Holders	36 3/4"	23 7/8"	51 7/8"	85 lbs.	90 lbs.	400 lbs.

TWO-PANEL FRAMED STEEL TOOLBOARD

- High-Grade Aluminum Frame
- Includes Two 18" x 36" Steel Toolboard Panels
- Height-Adjustable Panels; Simply Slide The Panels And Top Rail, Then Fasten Into Place!
- Secure Tools With Steel Toolholders (Sold Separately)
- Some Assembly Required
- Double Sided



Tools & tool holders not included

MASTER No.	ITEM DESCRIPTION	WIDTH	DEPTH	HEIGHT	NET WT	SHIP WT	CAPACITY
50067	2-Panel Toolboard Frame	39"	24"	75"	45 lbs.	50 lbs.	1,265 lbs.

THREE-PANEL FRAMED STEEL TOOLBOARD

- High-Grade Aluminum Frame
- Includes Three 18" x 36" Reinforced Steel Toolboard Panels
- Height-Adjustable Panels; Simply Slide The Panels And Top Rail, Then Fasten Into Place!
- Secure Tools With Steel Toolholders (Sold Separately)
- Some Assembly Required
- Double Sided

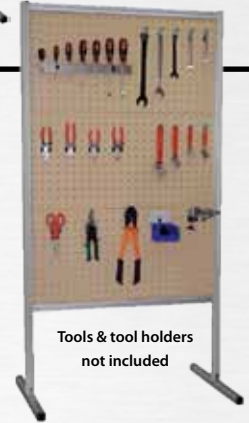

Tools & tool holders not included

MASTER No.	ITEM DESCRIPTION	WIDTH	DEPTH	HEIGHT	NET WT	SHIP WT	CAPACITY
50068	3-Panel Toolboard Frame	39"	24"	75"	70 lbs.	75 lbs.	1,944 lbs.

TWO-PANEL BENCHMARK FRAMED TOOLBOARD

- High-Grade Aluminum Frame
- Includes Two 18" x 36" Reinforced Steel Toolboard Panels
- Attaches To Any Work Surface (Mounting Brackets And Hardware Included)
- Secure Tools With Steel Toolholders (Sold Separately)
- Some Assembly Required
- Double Sided



Tools & tool holders not included

MASTER No.	ITEM DESCRIPTION	WIDTH	DEPTH	HEIGHT	NET WT	SHIP WT	CAPACITY
50070	2-Panel Benchmark	39"	1 1/2"	40"	35 lbs.	40 lbs.	1,296 lbs.

MAGNETIC VINYL TOOL CONTROL SHEETS

- Enhance Your Visual Tool Control At A Glance!
- Cutouts Made From Magnetic Colored Vinyl Let You Identify Missing Tools Instantly
- Simply Trace Tools With An Erasable Marker, Cut Out The Shapes, & Apply To Panels
- Cutouts Peel Off Easily For Effortless Repositioning

MASTER No.	ITEM DESCRIPTION	WIDTH	DEPTH	COLOR
99814	Vinyl Control Sheet	24"	18"	Red
99815	Vinyl Control Sheet	24"	18"	Blue
99816	Vinyl Control Sheet	24"	18"	White
99817	Vinyl Control Sheet	24"	18"	Yellow

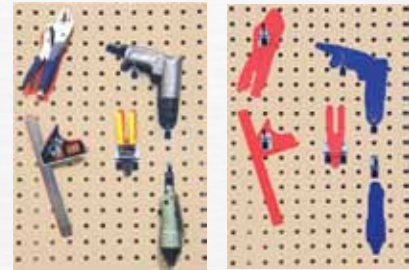

TOOLBOARD SYSTEM MOBILE PACKAGES

- Fits Models 50067 & 50068
- Includes Caster Set (2 Rigid, 2 Swivel), Mounting Plates, & Hardware
- Model 50083 - 3 1/2" x 1 1/4" Caster Set
- Model 50081 - 5" x 1 1/4" Caster Set

MASTER No.	ITEM DESCRIPTION	WIDTH	DEPTH	HEIGHT	NET WT	SHIP WT	CAPACITY
50083	3 1/2" x 1 1/4" Caster Set	5"	2"	6"	24 lbs.	25 lbs.	-
50081	5" x 1 1/4" Caster Set	5"	1 1/4"	6"	29 lbs.	30 lbs.	-



TOOLBOARD PUSH/PULL HANDLE ACCESSORY

- Plastic Push Handle Can Be Positioned At Any Height Along Toolboard Frame
- Fits Models 50067 & 50068
- Includes Mounting Hardware

MASTER No.	ITEM DESCRIPTION	WIDTH	DEPTH	HEIGHT	NET WT	SHIP WT	CAPACITY
50053	Plastic Push Handle	1"	1 7/8"	7 3/4"	.5 lbs.	1 lbs.	-



MINI WORKSHOP CABINET

- Heavy Gauge Welded Steel
- 3-Point Locking Doors With 2 Keys
- Full-Length Toolboard Panels On Inner Doors
- Two 18" x 36" Panels Installed On Cabinet Back
- 3 Full-Width Drawers With Ball-Bearing Slides (165 lb. Capacity)
- 36" x 20" x 1 1/2" Thick Butcher Block Maple Work Surface
- 1 Adjustable, Full-Width Shelf (220 lb Capacity)
- Easy-Pull Drawer Handles With Label Holders
- Includes 60-Piece Toolholder Set (99853)

MODEL: 50301	DRS.	WIDTH	DEPTH	HEIGHT	CAPACITY
DRAWERS:	3	34 3/8"	17 3/8"	4"	120 lbs.
SHELF:	1	35 7/8"	19 5/8"	1 3/4"	120 lbs.

MASTER No.	ITEM DESCRIPTION	WIDTH	DEPTH	HEIGHT	NET WT	SHIP WT	CAPACITY
50301	Mini-Workshop Cabinet	39 1/4"	23 1/4"	76"	463 lbs.	478 lbs.	52,542 cu. in.



Tools not included.

MINI WORKSHOP CABINET ADDITIONAL DRAWER

- Add A Drawer To Your Mini Workshop Cabinet For Extra Storage
- Includes One Drawer With Drawer Slides And Pull With Label Holder

MASTER No.	ITEM DESCRIPTION	WIDTH	DEPTH	HEIGHT	NET WT	SHIP WT
50310	Additional Drawer	34 3/8"	17 3/8"	4"	19.5 lbs.	22.0 lbs.



MINI WORKSHOP CABINET DRAWER DIVIDER KITS

- Keep Small Parts Organized By Dividing Drawers Into Compartments
- Model 69050 - Nine Compartment Divider Kit
- Model 69051 - Twenty Compartment Divider Kit

MASTER No.	ITEM DESCRIPTION	SHIP WT
69050	9-Cmp't Divider Kit	3.60 lbs.
69051	20-Cmp't Divider Kit	6.40 lbs.

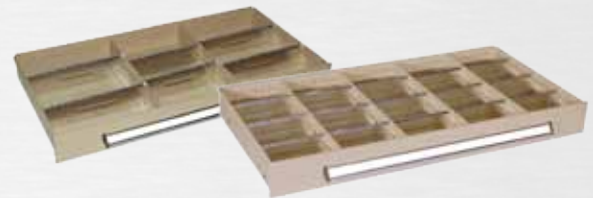

WALL MOUNTED CABINETS

MODEL 50260

- Ruggedly Constructed Steel Cabinet With 2-Point Locking Doors
- Square Hole Perforated Cabinet Back And Inner Door Panels
- Swing-Out Inner Panels Are 24" x 18" And Provide Additional Storage For Flat Tools
- Includes 60-Piece Toolholder Set (99853)

MODEL 50230

- Comes Without The Swing-Out Inner Panels
- Includes 30-Piece Toolholder Set (99852)

MASTER No.	ITEM DESCRIPTION	WIDTH	DEPTH	HEIGHT	NET WT	SHIP WT	CAPACITY
50260	Wall Mounted Cabinet	44 1/2"	11 7/8"	39 3/8"	100 lbs.	120 lbs.	19,601 cu. in.
50230	No Panels Wall Cabinet	44 1/2"	11 7/8"	39 3/8"	83 lbs.	96 lbs.	19,601 cu. in.



Tools not included.

ALL WELDED STORAGE CABINET

- Made Of Heavy 16 Gauge Steel
- 3-Point Locking System Ensures Maximum Security
- Comes With 3 Shelves That Can Hold Up To 200 lbs. Each
- Steel Toolboard Panels Inside Doors
- Includes 20-Piece Toolholder Set (99820 & 99821)

MODEL 10351: STORAGE CABINET SHELF

- Extra Shelves Can Be Added For More Storage Capacity

MODEL: 10350	QTY.	WIDTH	DEPTH	HEIGHT	CAPACITY
SHELVES:	3	36"	21"	1 3/4"	-

MASTER No.	ITEM DESCRIPTION	WIDTH	DEPTH	HEIGHT	NET WT	SHIP WT	CAPACITY
10350	Welded Storage Cabinet	39 1/4"	23 1/4"	76"	405 lbs.	430 lbs.	52,542 cu. in.
10351	Storage Cabinet Shelf	36"	21"	1 3/4"	18 lbs.	20 lbs.	-



TOOLBOARD STORAGE BAGS

MODEL 50051: 21" x 16"

- Has 8 Pockets, Each With Additional Clear Storage Pocket
- Mounts Onto Kennedy Toolholder Hooks

MODEL 50052: 16" x 24"

- Has 5 Netted Pockets And 12 Hand Tool Loops
- Mounts Onto Kennedy Toolholder Hooks

MASTER No.	ITEM DESCRIPTION	WIDTH	DEPTH	HEIGHT	NET WT	SHIP WT	CAPACITY
50051	21" x 16" Storage Bag	21"	-	16"	.75 lbs.	1 lbs.	-
50052	16" x 24" Storage Bag	16"	-	24"	.75 lbs.	1 lbs.	-



Model: 50051



Model: 50052

TOOLHOLDER SETS

MODEL 99851 - 10PC TOOLHOLDER SET CONTAINS:

- 4 Single Verticle End Hooks
- 2 Single Angled End Hooks
- 4 Double Verticle End Hooks

MODEL 99852 - 30PC TOOLHOLDER SET CONTAINS:

- 17 Assorted Single Hooks
- 4 Assorted Double Hooks
- 2 Assorted Plier Hooks
- 4 Assorted Spring Clips
- 1 Ring Hook, Screwdriver Unit, & Wrench Rack

MODEL 99853 - 60PC TOOLHOLDER SET CONTAINS:

- 33 Assorted Single Hooks
- 9 Assorted Double Hooks
- 4 Assorted Plier Hooks
- 10 Assorted Spring Clips
- 1 Ring Hook, Screwdriver Unit, & Wrench Rack
- 1 Allen Key Unit



Panel not included



Panel not included



Panel not included

MASTER No. ITEM DESCRIPTION

99851	10pc Toolholder Set
99852	30pc Toolholder Set
99853	60pc Toolholder Set

TOOLHOLDER ACCESSORIES

SINGLE HOOK - VERTICAL END

UPC No.	PKG. QTY.	LENGTH	DIA.	CAPACITY
99820	10 pcs.	1"	¼"	20 lbs.
99821	10 pcs.	2"	¼"	20 lbs.
99822	10 pcs.	3"	¼"	20 lbs.



SINGLE HOOK - ANGLED END

UPC No.	PKG. QTY.	LENGTH	DIA.	CAPACITY
99823	10 pcs.	2 ¾"	¼"	20 lbs.
99824	10 pcs.	4"	¼"	20 lbs.
99825	10 pcs.	6"	¼"	20 lbs.



DOUBLE HOOK - VERTICAL END

UPC No.	PKG. QTY.	LENGTH	DIA.	CAPACITY
99827	10 pcs.	1"	1 ¾"	40 lbs.
99828	10 pcs.	2"	1 ¾"	40 lbs.



ALLEN KEY UNIT

UPC No.	PKG. QTY.	LENGTH	DIA.	CAPACITY
99842	1 pcs.	-	-	3 lbs.

- Stores up to 9-piece metric or imperial key set
- Gray finish



PLIER HOOK

UPC No.	PKG. QTY.	LENGTH	WIDTH	CAPACITY
99831	10 pcs.	1 ¾"	¾"	40 lbs.
99832	10 pcs.	2 ½"	¾"	40 lbs.



SINGLE SPRING CLIPS

UPC No.	PKG. QTY.	LENGTH	DIA.	CAPACITY
99833	10 pcs.	-	½"	3 lbs.
99835	10 pcs.	-	¾"	3 lbs.
99836	10 pcs.	-	1"	3 lbs.



RING HOOK

UPC No.	PKG. QTY.	LENGTH	DIA.	CAPACITY
99839	2 pcs.	-	2 ¾"	40 lbs.



SCREWDRIVER UNIT

UPC No.	PKG. QTY.	LENGTH	DIA.	CAPACITY
99840	1 pcs.	-	-	10 lbs.

- Stores up to 12 screwdrivers, chisels, files, etc
- Gray finish

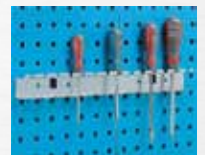

DOUBLE HOOK - ANGLED END

UPC No.	PKG. QTY.	LENGTH	DIA.	CAPACITY
99829	10 pcs.	2"	1"	40 lbs.
99830	10 pcs.	4"	1"	40 lbs.



WRENCH RACK

UPC No.	PKG. QTY.	LENGTH	DIA.	CAPACITY
99841	1 pcs.	-	-	15 lbs.

- Stores up to 8 wrenches
- Gray finish



PARTS SHELF

UPC No.	PKG. QTY.	LENGTH	DIA.	CAPACITY
99846	1 pcs.	17 ¾"	6 ¾"	40 lbs.



CABLE LOOP HOOK SET

UPC No.	PKG. QTY.	LENGTH	DIA.	CAPACITY
99876	5 pcs.	6"	-	20 lbs.



PLASTIC BIN STORAGE STRIP

UPC No.	PKG. QTY.	LENGTH	DIA.	CAPACITY
99847	1 pcs.	4"	-	20 lbs.
99848	1 pcs.	17 ¾"	-	40 lbs.

- Gray finish



STAINLESS STEEL CABINETS

Stainless steel storage cabinets are designed for the laboratory/cleanroom environment. Kennedy cleanroom roller cabinets provide the convenience of lockable mobile work stations with secure storage of tools, components and supplies.

Product Features:

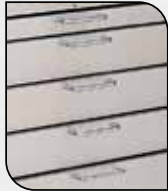

Stainless Steel Drawer Pulls



Ball-Bearing Drawer Slides Hold Up To 120 lbs



5" x 1" Non-Marking Polyurethane Casters w/ Grease Seals



Stainless Steel Push Handle



Pictured:
Model 28085 - 5 Drawer Cart

5 DRAWER STAINLESS STEEL CABINET - CLASS 100

- Class 100: Cleanroom Certified
- Shipped In A Non-Static Generating Bag To Prevent Contamination
- High Security Tubular Lock/Key Set
- 304 Stainless Steel Body And Drawers; #4 Brushed Finish

MODEL: 28085	DRS.	WIDTH	DEPTH	HEIGHT	CAPACITY
DRAWERS:	1	25"	18 1/2"	2"	120 lbs.
	3	25"	18 1/2"	4"	120 lbs.
	1	25"	18 1/2"	10"	120 lbs.

MASTER No.	ITEM DESCRIPTION	WIDTH	DEPTH	HEIGHT	NET WT	SHIP WT	CAPACITY
28085	5-Drawer Cabinet	29"	20"	35"	126 lbs.	141 lbs.	10,235 cu. in.

7 DRAWER STAINLESS STEEL CABINET - CLASS 100

- Class 100: Cleanroom Certified
- Shipped In A Non-Static Generating Bag To Prevent Contamination
- High Security Tubular Lock/Key Set
- 304 Stainless Steel Body And Drawers
- #4 Brushed Finish

MODEL: 28087	DRS.	WIDTH	DEPTH	HEIGHT	CAPACITY
DRAWERS:	3	25"	18 1/2"	2"	120 lbs.
	3	25"	18 1/2"	4"	120 lbs.
	1	25"	18 1/2"	6"	120 lbs.

MASTER No.	ITEM DESCRIPTION	WIDTH	DEPTH	HEIGHT	NET WT	SHIP WT	CAPACITY
28087	7-Drawer Cabinet	29"	20"	35"	145 lbs.	156 lbs.	10,235 cu. in.



7 DRAWER STAINLESS STEEL CABINET - CLASS 10

- Class 10: Cleanroom Certified
- Easily Accessible Lock With 2, 3, 4 or 5-Digit Combinations
- No Batteries Required For Operation
- Mechanical Override Key Has Dimple Design To Avoid Unauthorized Copying.
- 304 Stainless Steel Body And Drawers
- #4 Brushed Finish

MODEL: 28197	DRS.	WIDTH	DEPTH	HEIGHT	CAPACITY
DRAWERS:	3	25"	18 1/2"	2"	120 lbs.
	3	25"	18 1/2"	4"	120 lbs.
	1	25"	18 1/2"	6"	120 lbs.

MASTER No.	ITEM DESCRIPTION	WIDTH	DEPTH	HEIGHT	NET WT	SHIP WT	CAPACITY
28197	7-Drawer Cabinet	29"	20"	35"	145 lbs.	156 lbs.	10,235 cu. in.



PLASTIC WORK SURFACE ACCESSORY

- Seamless, ABS White Plastic Cover Fits Snugly Over Roller Cabinet Top
- Quarter-Inch Raised Lip Helps Prevent Roll Offs
- Easy To Clean; Adds Finished Look

MASTER No.	ITEM DESCRIPTION	WIDTH	DEPTH	HEIGHT	NET WT	SHIP WT	CAPACITY
29000	Plastic Work Surface	29"	20"	1"	3 lbs.	3.5 lbs.	-



MODULAR STORAGE SYSTEMS

You may order pre-configured cabinets shown or custom design your own. See our modular cabinet configurator at www.kennedymfg.com. Accessories are also available to keep tools organized on page 42.

Product Features:



Drawer Slide Capacities:
(NX) 220 lbs.
(FX) 550 lbs.



One Drawer At A Time
Interlocking System



Up To 30% More Total
Storage Volume Than
Competing Brands, Plus
The Highest Weight
Capacity In The Industry



Welded Corner Brackets
Ensure Maximum
Strength & Rigidity



Ribbed Black Vinyl Top
Mat Provides A Durable
Work Surface



Drawer Dividers For
Organized Storage
(Sold Separately)



Model 40097UB
with Mobile Package

Model 63606

WARNING

Unit May Tip
Close and Lock Drawers Before Moving
Use one Drawer at a Time
Do Not Pull Unit
Push to Move

It is highly recommended that modular cabinets be bolted to the floor to prevent tipping/serious injury.



Customize the color of your products. Simply place one of the abbreviations at the end of the model number.



Extra lead time required.

METAL THICKNESS	
Frame	18 ga
Drawers	18 ga

24" X 24" MODULAR CABINETS

- NS Drawers Extend 90% And Have 220 lbs. Per Drawer Load Capacity
- Full-Width Drawer Pulls Come With Label Strips And Plastic Protectors



Modular Workstation with two 61303TX cabinets and one WT6030 maple top.



DRAWER DIMENSIONS

DRS.	W	x	D	x	H
2	20 1/2"		20 1/2"		3"
2	20 1/2"		20 1/2"		4"
1	20 1/2"		20 1/2"		6"
2	20 1/2"		20 1/2"		8"

7-DRAWER CABINET

MASTER No.	WIDTH	DEPTH	HEIGHT	NET WT	SHIP WT	STORAGE	CAPACITY
61407	24"	24"	39 3/8"	214 lbs.	234 lbs.	15,128 cu. in.	1,540 lbs.

DRAWER DIMENSIONS

DRS.	W	x	D	x	H
2	20 1/2"		20 1/2"		3"
3	20 1/2"		20 1/2"		4"
2	20 1/2"		20 1/2"		6"
2	20 1/2"		20 1/2"		8"

9-DRAWER CABINET

MASTER No.	WIDTH	DEPTH	HEIGHT	NET WT	SHIP WT	STORAGE	CAPACITY
61509	24"	24"	49 3/8"	263 lbs.	283 lbs.	19,331 cu. in.	1,980 lbs.

DRAWER DIMENSIONS

DRS.	W	x	D	x	H
2	20 1/2"		20 1/2"		4"
2	20 1/2"		20 1/2"		6"
1	20 1/2"		20 1/2"		8"

5-DRAWER CABINET

MASTER No.	WIDTH	DEPTH	HEIGHT	NET WT	SHIP WT	STORAGE	CAPACITY
61303	24"	24"	31 7/16"	146 lbs.	166 lbs.	11,767 cu. in.	1,100 lbs.

DRAWER DIMENSIONS

DRS.	W	x	D	x	H
1	20 1/2"		20 1/2"		2"
1	20 1/2"		20 1/2"		4"
3	20 1/2"		20 1/2"		6"
1	20 1/2"		20 1/2"		8"

6-DRAWER CABINET

MASTER No.	WIDTH	DEPTH	HEIGHT	NET WT	SHIP WT	STORAGE	CAPACITY
61703	24"	24"	35 3/8"	164 lbs.	184 lbs.	13,448 cu. in.	1,320 lbs.

24" x 24" Housings: Custom Design

- Cabinet housings can be filled only with normal suspension (NS) drawers. NS drawers have a load capacity of 220 lbs. (100 kgs.) with 90% extension capability.
- Select any combination of drawer front heights that equal the usable height of the cabinet.
- Drawers for all 24" x 24" cabinets are listed below.



Housing No. 61300
Usable Height 28"

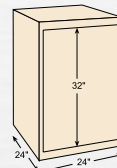

Housing No. 61700
Usable Height 32"

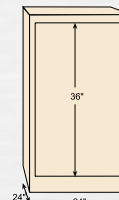

Housing No. 61400
Usable Height 36"

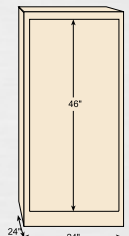

Housing No. 61500
Usable Height 46"



NS drawers have 90% rail extension; 220 lbs. capacity.

NS Model #	Front Height	Usable Height	Inch	Sidewall Height	Inch	Cubic Ft.	Load Capacity	
							Lbs.	Extension
51002	2"	1.46	1.38	.35	220	90%		
51003	3"	2.44	2.17	.59	220	90%		
51004	4"	3.43	3.35	.83	220	90%		
51005	5"	4.41	3.35	1.06	220	90%		
51006	6"	5.39	3.35	1.30	220	90%		
51007	7"	6.38	3.35	1.55	220	90%		
51008	8"	7.36	3.35	1.78	220	90%		
51009	9"	8.35	3.35	2.03	220	90%		
51010	10"	9.33	3.35	2.26	220	90%		
51012	12"	11.30	3.35	2.74	220	90%		
51014	14"	13.27	3.35	3.22	220	90%		
51016	16"	15.24	3.35	3.70	220	90%		

Standard Width Drawers

- Drawer pans have perforations for easy installation of dividers and accessories.
- Drawer fronts bolt on to allow changing drawer heights easily as storage needs change. Inside dimensions of drawers are 20.5" x 20.5".

Drawer Divider Sets for 24" x 24" Cabinets

To order, use the four digit number and add the number 2, 3 or 4 as a suffix. To order a divider set 9110 for a 2" drawer, order number 91102, 91103 for 3" drawer and 91104 for 4"-16" drawer. Taller subdividers and partitions are available on request.

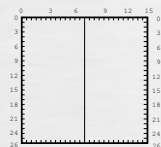

9110
2 Comp.
10" x 20.5"

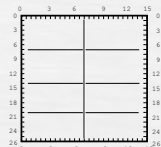

9113
8 Comp.
10" x 4.75"

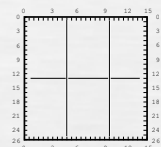

9121
6 Comp.
6.25" x 10"

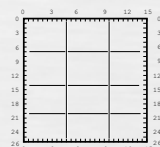

9123
12 Comp.
6.25" x 4.75"

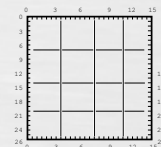

9133
16 Comp.
4.75" x 4.75"

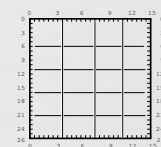

9134
20 Comp.
4.75" x 3.75"

30" X 24" MODULAR CABINETS

- FX Drawers Extend 100% And Have 550 lbs. Per Drawer Load Capacity
- Drawer Slides Move Smoothly On Precision Ball-Bearings
- Full-Width Drawer Pulls Come With Label Strips And Plastic Protectors



62407



62509



62610

DRAWER DIMENSIONS

DRS.	W	x	D	x	H
2	26"		20 1/2"		3"
2	26"		20 1/2"		4"
1	26"		20 1/2"		6"
2	26"		20 1/2"		8"

7-DRAWER CABINET

MASTER No.	WIDTH	DEPTH	HEIGHT	NET WT	SHIP WT	STORAGE	CAPACITY
62407	30"	24"	39 3/8"	302 lbs.	322 lbs.	19,188 cu. in.	3,850 lbs.

DRAWER DIMENSIONS

DRS.	W	x	D	x	H
2	26"		20 1/2"		3"
3	26"		20 1/2"		4"
2	26"		20 1/2"		6"
2	26"		20 1/2"		8"

9-DRAWER CABINET

MASTER No.	WIDTH	DEPTH	HEIGHT	NET WT	SHIP WT	STORAGE	CAPACITY
62509	30"	24"	49 3/8"	363 lbs.	383 lbs.	24,518 cu. in.	4,950 lbs.

DRAWER DIMENSIONS

DRS.	W	x	D	x	H
1	26"		20 1/2"		3"
4	26"		20 1/2"		4"
2	26"		20 1/2"		6"
3	26"		20 1/2"		8"

10-DRAWER CABINET

MASTER No.	WIDTH	DEPTH	HEIGHT	NET WT	SHIP WT	STORAGE	CAPACITY
62610	30"	24"	59 3/8"	385 lbs.	405 lbs.	29,315 cu. in.	5,500 lbs.

30" x 24" Housings: Custom Design

- To order custom designed cabinets, fill with drawers listed below.
- Drawer front heights must add up to the usable height in the housing.



FX drawers have 100% rail extension; 550 lbs. capacity.

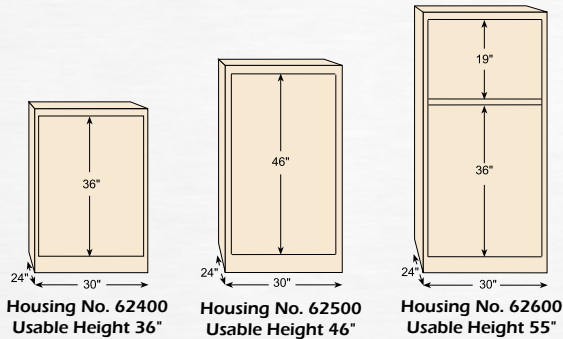

Drawers for 30" x 24" Cabinets

- Drawer pans have perforations for easy installation of dividers and accessories.
- Drawer fronts bolt on to allow changing drawer heights easily as storage needs change. Inside dimensions of drawers are 26" x 20.5".

FX Model #	Front Height	Usable Height Inches	Sidewall Height Inches	Load Capacity Cubic Ft.	Load Capacity Lbs.	Extension
52103	3"	2.44	2.17	.75	550	100%
52104	4"	3.43	3.35	1.05	550	100%
52105	5"	4.41	3.35	1.35	550	100%
52106	6"	5.39	3.35	1.66	550	100%
52107	7"	6.38	3.35	1.96	550	100%
52108	8"	7.36	3.35	2.26	550	100%
52109	9"	8.35	3.35	2.57	550	100%
52110	10"	9.33	3.35	2.87	550	100%
52112	12"	11.30	3.35	3.47	550	100%
52114	14"	13.27	3.35	4.08	550	100%
52116	16"	15.24	3.35	4.69	550	100%

Drawer Divider Sets for 30" x 24" Cabinets

Choose any divider set below that meets your needs. To order, use the four digit number and add the number 2, 3 or 4 as a suffix. To order a divider set 9211 for a 2" drawer, order number 92112, 92113 for 3" drawer and 92114 for 4"-16" drawer. Taller subdividers and partitions are available on request.

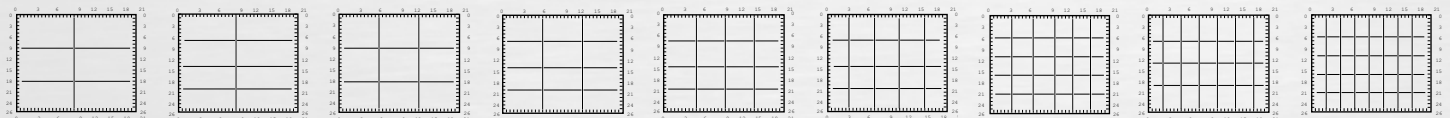

9212 6 Comp. 13" x 6.25"	9213 8 Comp. 13" x 4.75"	9222 9 Comp. 8.5" x 6.25"	9223 12 Comp. 8.5" x 4.75"	9233 16 Comp. 6" x 4.75"	9243 20 Comp. 4.75" x 4.75"	9254 30 Comp. 3.75" x 3.75"	9263 28 Comp. 3" x 4.75"	9274 28 Comp. 3" x 3.75"
---------------------------------------	---------------------------------------	--	---	---------------------------------------	--	--	---------------------------------------	---------------------------------------

30" X 30" X 40" MODULAR CABINETS

- Available With NX or FX Drawer Slides
- NX Drawers Extend 87% And Have 220 lbs. Per Drawer Load Capacity
- FX Drawers Extend 100% And Have 550 lbs. Per Drawer Load Capacity
- Drawer Slides Move Smoothly On Precision Ball-Bearings
- Full-Width Drawer Pulls Come With Label Strips And Plastic Protectors

DRAWER DIMENSIONS

DRS.	W	x	D	x	H
4	26"		26"		2"
1	26"		26"		4"
2	26"		26"		6"
1	26"		26"		8"

8-DRAWER CABINETS

MASTER No.	WIDTH	DEPTH	HEIGHT	NET WT	SHIP WT	STORAGE	CAPACITY
63405NX	30"	30"	39 5/8"	273 lbs.	293 lbs.	24,336 cu. in.	1,760 lbs.
63406FX	30"	30"	39 5/8"	360 lbs.	380 lbs.	24,336 cu. in.	4,400 lbs.



63405NX
63406FX

DRAWER DIMENSIONS

DRS.	W	x	D	x	H
4	26"		26"		4"
2	26"		26"		6"
1	26"		26"		8"

7-DRAWER CABINETS

MASTER No.	WIDTH	DEPTH	HEIGHT	NET WT	SHIP WT	STORAGE	CAPACITY
63407NX	30"	30"	39 5/8"	260 lbs.	280 lbs.	24,336 cu. in.	1,540 lbs.
63408FX	30"	30"	39 5/8"	339 lbs.	359 lbs.	24,336 cu. in.	2,850 lbs.

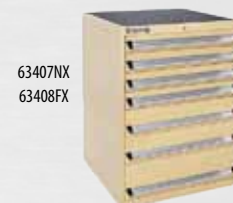

63407NX
63408FX

DRAWER DIMENSIONS

DRS.	W	x	D	x	H
6	26"		26"		6"

6-DRAWER CABINETS

MASTER No.	WIDTH	DEPTH	HEIGHT	NET WT	SHIP WT	STORAGE	CAPACITY
63409NX	30"	30"	39 5/8"	248 lbs.	268 lbs.	24,336 cu. in.	1,320 lbs.
63410FX	30"	30"	39 5/8"	314 lbs.	334 lbs.	24,336 cu. in.	3,300 lbs.



63409NX
63410FX

DRAWER DIMENSIONS

DRS.	W	x	D	x	H
2	26"		26"		4"
2	26"		26"		6"
2	26"		26"		8"

6-DRAWER CABINETS

MASTER No.	WIDTH	DEPTH	HEIGHT	NET WT	SHIP WT	STORAGE	CAPACITY
63411NX	30"	30"	39 5/8"	246 lbs.	266 lbs.	24,336 cu. in.	1,320 lbs.
63412FX	30"	30"	39 5/8"	313 lbs.	333 lbs.	24,336 cu. in.	3,300 lbs.



63411NX
63412FX

DRAWER DIMENSIONS

DRS.	W	x	D	x	H
12	26"		26"		3"

12-DRAWER CABINETS

MASTER No.	WIDTH	DEPTH	HEIGHT	NET WT	SHIP WT	STORAGE	CAPACITY
63416NX	30"	30"	39 5/8"	326 lbs.	346 lbs.	24,336 cu. in.	2,640 lbs.
63417FX	30"	30"	39 5/8"	452 lbs.	472 lbs.	24,336 cu. in.	6,600 lbs.



63416NX
63417FX

DRAWER DIMENSIONS

DRS.	W	x	D	x	H
1	26"		26"		2"
2	26"		26"		3"
4	26"		26"		4"
2	26"		26"		6"

8-DRAWER CABINETS

MASTER No.	WIDTH	DEPTH	HEIGHT	NET WT	SHIP WT	STORAGE	CAPACITY
63418NX	30"	30"	39 5/8"	287 lbs.	307 lbs.	24,336 cu. in.	1,760 lbs.
63419FX	30"	30"	39 5/8"	380 lbs.	400 lbs.	24,336 cu. in.	4,400 lbs.



63418NX
63419FX

DRAWER DIMENSIONS

DRS.	W	x	D	x	H
1	26"		26"		4"
2	26"		26"		6"
1	26"		26"		12"

4-DRAWER MACHINE CABINET

MASTER No.	WIDTH	DEPTH	HEIGHT	NET WT	SHIP WT	STORAGE	CAPACITY
63303	30"	30"	31 7/8"	246 lbs.	266 lbs.	24,336 cu. in.	1,320 lbs.



63303

WARNING

Unit May Tip
Close and Lock Drawers Before Moving
Use one Drawer at a Time
Do Not Pull Unit
Push to Move

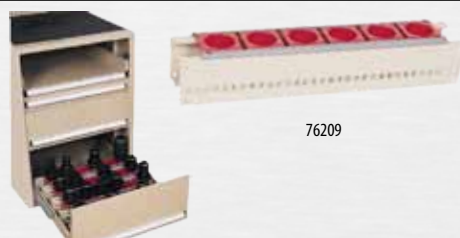

76209

SOCKET PARTITION

- Each Drawer Holds Four Partitions
- Each Partition Will Hold: (6) Susta 70053 50 Taper Sockets
(8) Susta 70051 40 Taper Sockets
(8) Susta 70059 30 Taper Sockets

MASTER No.	WIDTH	DEPTH	HEIGHT	NET WT	SHIP WT
76209	25 7/8"	1"	4 1/4"	7 lbs.	7.5 lbs.

It is highly recommended that modular cabinets be bolted to the floor to prevent tipping/serious injury.

30" X 30" X 60" MODULAR CABINETS

- Available With NX or FX Drawer Slides
- NX Drawers Extend 87% And Have 220 lbs. Per Drawer Load Capacity
- FX Drawers Extend 100% And Have 550 lbs. Per Drawer Load Capacity
- Drawer Slides Move Smoothly On Precision Ball-Bearings
- Full-Width Drawer Pulls Come With Label Strips And Plastic Protectors

DRAWER DIMENSIONS

DRS.	W	x	D	x	H
5	26"		26"		3"
4	26"		26"		4"
2	26"		26"		5"
1	26"		26"		6"
1	26"		26"		8"

13-DRAWER CABINETS

MASTER No.	WIDTH	DEPTH	HEIGHT	NET WT	SHIP WT	STORAGE	CAPACITY
63605NX	30"	30"	59 1/2"	401 lbs.	421 lbs.	37,180 cu. in.	2,860 lbs.
63606FX	30"	30"	59 1/2"	545 lbs.	565 lbs.	37,180 cu. in.	7,150 lbs.



DRAWER DIMENSIONS

DRS.	W	x	D	x	H
2	26"		26"		4"
1	26"		26"		5"
1	26"		26"		6"
2	26"		26"		4"
2	26"		26"		6"
2	26"		26"		8"

10-DRAWER CABINETS

MASTER No.	WIDTH	DEPTH	HEIGHT	NET WT	SHIP WT	STORAGE	CAPACITY
63609NX	30"	30"	59 1/2"	361 lbs.	381 lbs.	37,180 cu. in.	2,200 lbs.
63610FX	30"	30"	59 1/2"	474 lbs.	494 lbs.	37,180 cu. in.	5,500 lbs.

63609NX
63610FX



DRAWER DIMENSIONS

DRS.	W	x	D	x	H
2	26"		26"		6"
1	26"		26"		7"
6	26"		26"		6"

9-DRAWER CABINETS

MASTER No.	WIDTH	DEPTH	HEIGHT	NET WT	SHIP WT	STORAGE	CAPACITY
63611NX	30"	30"	59 1/2"	350 lbs.	370 lbs.	37,180 cu. in.	1,980 lbs.
63612FX	30"	30"	59 1/2"	449 lbs.	469 lbs.	37,180 cu. in.	4,950 lbs.

63611NX
63612FX



DRAWER DIMENSIONS

DRS.	W	x	D	x	H
5	26"		26"		3"
1	26"		26"		4"
12	26"		26"		3"

18-DRAWER CABINETS

MASTER No.	WIDTH	DEPTH	HEIGHT	NET WT	SHIP WT	STORAGE	CAPACITY
63616NX	30"	30"	59 1/2"	467 lbs.	487 lbs.	37,180 cu. in.	3,960 lbs.
63617FX	30"	30"	59 1/2"	675 lbs.	677 lbs.	37,180 cu. in.	9,900 lbs.

63616NX
63617FX



DRAWER DIMENSIONS

DRS.	W	x	D	x	H
3	26"		26"		3"
1	26"		26"		4"
1	26"		26"		6"
3	26"		26"		4"
2	26"		26"		6"
1	26"		26"		12"

11-DRAWER CABINETS

MASTER No.	WIDTH	DEPTH	HEIGHT	NET WT	SHIP WT	STORAGE	CAPACITY
63618NX	30"	30"	59 1/2"	373 lbs.	393 lbs.	37,180 cu. in.	2,420 lbs.
63619FX	30"	30"	59 1/2"	458 lbs.	478 lbs.	37,180 cu. in.	6,050 lbs.

63618NX
63619FX



DRAWER DIMENSIONS

DRS.	W	x	D	x	H
2	26"		26"		3"
2	26"		26"		4"
1	26"		26"		5"
3	26"		26"		6"
1	26"		26"		8"
1	26"		26"		10"

10-DRAWER CABINETS

MASTER No.	WIDTH	DEPTH	HEIGHT	NET WT	SHIP WT	STORAGE	CAPACITY
63620NX	30"	30"	59 1/2"	350 lbs.	380 lbs.	37,180 cu. in.	2,200 lbs.
63621FX	30"	30"	59 1/2"	471 lbs.	491 lbs.	37,180 cu. in.	5,500 lbs.

63620NX
63621FX



WARNING

Unit May Tip
Close and Lock Drawers Before Moving.
Use one Drawer at a Time
Do Not Pull Unit
Push to Move

It is highly recommended that modular cabinets be bolted to the floor to prevent tipping/serious injury.



Customize the color of your products. Simply place one of the abbreviations at the end of the model number.



Extra lead time required.

Custom Designed Modular Cabinets

While we offer pre-engineered modular cabinets for your convenience, you may also design your own to fit special tool storage requirements. Log on to our website at www.kennedymfg.com to design your own modular cabinet. It's convenient and easy. Or, you may call our customer service department at 800-413-8665 and speak to one of our representatives for personalized assistance.

30" x 30" Standard Width Housings

Cabinet housings can be filled with full extension (FX), 550 lbs., or normal extension (NX), 220 lbs., drawers. They can be mixed within these cabinets for cost efficient combinations.

Select any combination of drawer front heights that equal the usable height of the cabinet. NX drawers can be converted to FX drawers at a later date if storage requirements change. All 2" drawers are NX type drawers.

Fork lift bases and pallet truck bases are available. See page 43 for more information. Dividers sets shown below. Other drawer accessories are on page 42.

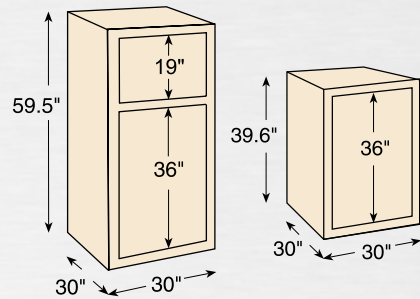

Housing No. 63600 Usable Height 55"
Housing No. 63400 Usable Height 36"

Standard Width Drawers for all 30" x 30" Cabinets

Drawer pans have perforations for easy installation of dividers and accessories. Drawer fronts bolt on to allow changing drawer heights easily as storage needs change. Inside dimensions of drawers are 26" x 26" giving 4.69 sq. ft. of storage area.



NX drawers have 87% rail extension; 220 lbs. capacity.



FX drawers have 100% rail extension; 550 lbs. capacity.

NX Model #	Front Height	Usable Height Inches	Sidewall Height Inches	Load Capacity		
				Cubic Ft.	Lbs.	Extension
63002	2"	1.46	1.38	.57	220	87%
63003	3"	2.44	2.17	.95	220	87%
63004	4"	3.43	3.35	1.34	220	87%
63005	5"	4.41	3.35	1.72	220	87%
63006	6"	5.39	3.35	2.11	220	87%
63008	8"	7.36	3.35	2.88	220	87%
FX Model #						
63103	3"	2.44	2.17	.95	550	100%
63104	4"	3.43	3.35	1.34	550	100%
63105	5"	4.41	3.35	1.72	550	100%
63106	6"	5.39	3.35	2.11	550	100%
63107	7"	6.38	3.35	2.49	550	100%
63108	8"	7.36	3.35	2.88	550	100%
63109	9"	8.35	3.35	3.26	550	100%
63110	10"	9.33	3.35	3.65	550	100%
63112	12"	11.30	3.35	4.42	550	100%
63114	14"	13.27	3.35	5.18	550	100%
63116	16"	15.24	3.35	5.96	550	100%

Drawer Divider Sets for 30" x 30" Cabinets

Choose any divider or box set below that meets your needs. To order, use the four digit number and add the number 2, 3 or 4 as a suffix. To order a divider set 9310 for a 2" drawer, order 93102, 93103 for a 3" drawer and 93104 for 4"-16" drawers. Taller subdividers and partitions are available on request. See page 39 for drawer divider components and accessories.

9310 2 Comp. 13" x 26"	9312 6 Comp. 13" x 8.5"	9313 8 Comp. 13" x 6.25"	9321 6 Comp. 8.5" x 13"	9322 9 Comp. 8.5" x 8.5"	9323 12 Comp. 8.5" x 6.25"	9324 15 Comp. 8.5" x 4.75"	9325 18 Comp. 8.5" x 3/75"
9333 16 Comp. 6" x 6.25"	9334 20 Comp. 6" x 4.75"	9335 24 Comp. 6" x 3.75"	9337 32 Comp. 6" x 3"	9342 15 Comp. 4.5" x 8.5"	9355 36 Comp. 3.75" x 3.75"	9364 35 Comp. 3" x 4.75"	9377 64 Comp. 3" x 3"

Extra wide cabinets are the most cost and space efficient modular cabinets for centralized large tool and parts storage. All Kennedy modular cabinet drawers and body are constructed of 18 gauge steel. Order pre-configured cabinets, or custom design your own. See our modular cabinet configurator at www.kennedymfg.com. or call our customer service department for personalized assistance. Accessories are also available to keep tools organized on page 42.

44" X 30" MODULAR CABINETS

- FX Drawers Extend 100% And Have 550 Lbs. Per Drawer Load Capacity
- Drawer Slides Move Smoothly On Precision Ball-Bearings
- Full-Width Drawer Pulls Come With Label Strips And Plastic Protectors

6-DRAWER CABINET

DRAWER DIMENSIONS					
DRS.	W	x	D	x	H
6	40 1/8"		26"		6"

MASTER No.	WIDTH	DEPTH	HEIGHT	NET WT	SHIP WT	STORAGE	CAPACITY
64404	44"	30"	39 3/8"	443 lbs.	463 lbs.	37,589 cu. in.	3,300 lbs.



64404

10-DRAWER CABINET

DRAWER DIMENSIONS					
DRS.	W	x	D	x	H
6	40 1/8"		26"		3"
3	40 1/8"		26"		4"
1	40 1/8"		26"		6"

MASTER No.	WIDTH	DEPTH	HEIGHT	NET WT	SHIP WT	STORAGE	CAPACITY
64408	44"	30"	39 3/8"	596 lbs.	616 lbs.	37,589 cu. in.	5,500 lbs.



64408

7-DRAWER CABINET

DRAWER DIMENSIONS					
DRS.	W	x	D	x	H
1	40 1/8"		26"		3"
2	40 1/8"		26"		4"
1	40 1/8"		26"		5"
2	40 1/8"		26"		6"
1	40 1/8"		26"		8"

MASTER No.	WIDTH	DEPTH	HEIGHT	NET WT	SHIP WT	STORAGE	CAPACITY
64410	44"	30"	39 3/8"	477 lbs.	497 lbs.	37,589 cu. in.	3,850 lbs.



64410

13-DRAWER CABINET

DRAWER DIMENSIONS					
DRS.	W	x	D	x	H
5	40 1/8"		26"		3"
4	40 1/8"		26"		4"
4	40 1/8"		26"		6"

MASTER No.	WIDTH	DEPTH	HEIGHT	NET WT	SHIP WT	STORAGE	CAPACITY
64606	44"	30"	59 1/2"	793 lbs.	813 lbs.	57,428 cu. in.	7,150 lbs.



64606

10-DRAWER CABINET

DRAWER DIMENSIONS					
DRS.	W	x	D	x	H
2	40 1/8"		26"		3"
2	40 1/8"		26"		4"
1	40 1/8"		26"		5"
2	40 1/8"		26"		6"
3	40 1/8"		26"		8"

MASTER No.	WIDTH	DEPTH	HEIGHT	NET WT	SHIP WT	STORAGE	CAPACITY
64608	44"	30"	59 1/2"	675 lbs.	695 lbs.	57,428 cu. in.	5,500 lbs.



64608

6-DRAWER CABINET

DRAWER DIMENSIONS					
DRS.	W	x	D	x	H
2	40 1/8"		26"		6"
1	40 1/8"		26"		7"
3	40 1/8"		26"		12"

MASTER No.	WIDTH	DEPTH	HEIGHT	NET WT	SHIP WT	STORAGE	CAPACITY
64610	44"	30"	59 1/2"	518 lbs.	538 lbs.	57,428 cu. in.	3,300 lbs.



64610

Custom Designed Modular Cabinets

While we offer pre-engineered modular cabinets for your convenience, you may also design your own to fit special tool storage requirements. Log on to our website at www.kennedymfg.com to design your own modular cabinet. It's convenient and easy. Or, you may call our customer service department at 800-413-8665 and speak to one of our representatives for personalized assistance.

44" x 30" Extra Wide Housings

Extra wide housings require full extension (FX), 550 lbs. drawers. Select any combination of drawer front heights that equal the usable height of the cabinet.

Drawers and drawer divider sets are listed below. All models are shipped assembled and come with lock and two keys. Additional accessories are on page 42. Fork lift base and pallet truck bases also available on page 43.

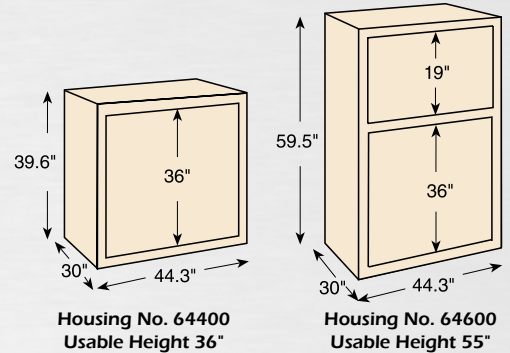

Extra Wide Drawers for all 44" x 30" Cabinets

Heavy-gauge, welded steel FX drawers are mounted on eight ball bearings for smooth operation under heavy loads. Drawer fronts bolt on to allow changing drawer heights easily as storage needs change. Inside dimensions of drawer are 40.16" W x 26" D.



FX drawers have 100% rail extension and 550 lbs. capacity.

FX Model #	Front Height	Usable Height Inches	Sidewall Height Inches	Cubic Ft.	Load Capacity Lbs.	Extension
64103	3"	2.32	2.00	1.40	550	100%
64104	4"	3.31	3.35	1.99	550	100%
64105	5"	4.29	3.35	2.59	550	100%
64106	6"	5.28	3.35	3.18	550	100%
64107	7"	6.38	3.35	3.85	550	100%
64108	8"	7.24	3.35	4.37	550	100%
64109	9"	8.35	3.35	5.04	550	100%
64110	10"	9.21	3.35	5.56	550	100%
64112	12"	11.18	3.35	6.75	550	100%
64114	14"	13.15	3.35	7.95	550	100%
64116	16"	15.12	3.35	9.12	550	100%

Drawer Divider Sets for Extra Wide Cabinets

Choose any divider set below that meets your needs. To order, use the four digit number and add the 3 or 4 as a suffix. To order divider set 9532 for a 3" drawer, order 95323 and 95324 for 4"-16" drawer. Taller subdividers and partitions are available on request. See page 42 for drawer divider components and accessories.

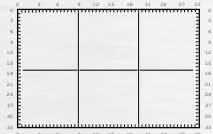

9521
6 Compartments
13" x 13"

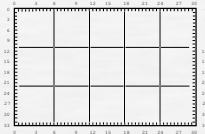

9542
15 Compartments
7.75" x 8.5"

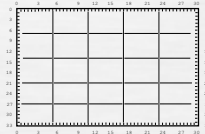

9544
25 Compartments
7.75" x 4.75"

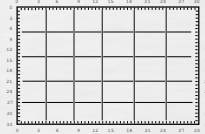

9544
30 Compartments
6.25" x 4.75"

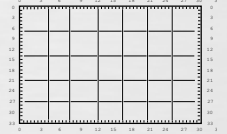

9564
35 Compartments
5.5" x 4.75"



It is highly recommended that modular cabinets be bolted to the floor to prevent tipping/serious injury.



Customize the color of your products. Simply place one of the abbreviations at the end of the model number.



Extra lead time required.

Kennedy's work stations include all the components you need for an individual bench or a complete work station complex. Featured are our most popular work station combinations. To order, choose the work station that suits your needs and a 60" or 72" maple top. You may order our standard combinations or custom design the units you need from individual components. See page 36 for cabinet housing and drawer information. Drawer dividers and accessories are on page 42.

MODULAR WORKSTATIONS

- NS Drawers Extend 87% And Have 220 lbs. Per Drawer Load Capacity
- Drawer Slides Move Smoothly On Precision Ball-Bearings
- Full-Width Drawer Pulls Come With Label Strips And Plastic Protectors

61303	DRS.	WIDTH	DEPTH	HEIGHT	CAPACITY
DRAWERS:	2	20 1/2"	20 1/2"	4"	220 lbs.
	2	20 1/2"	20 1/2"	6"	220 lbs.
	1	20 1/2"	20 1/2"	8"	220 lbs.

61703	DRS.	WIDTH	DEPTH	HEIGHT	CAPACITY
DRAWERS:	1	20 1/2"	20 1/2"	2"	220 lbs.
	1	20 1/2"	20 1/2"	4"	220 lbs.
	3	20 1/2"	20 1/2"	6"	220 lbs.
	1	20 1/2"	20 1/2"	8"	220 lbs.



- Model 69104 Includes:**
- Two adjustable legs no. 66200
 - One 60" top no. WT6030 or
 - One 72" top no. WT7230
 - Order top separately (shown below)



- Model 69146 Includes:**
- One adjustable leg no. 66200
 - one 61703, 24" x 24" cabinet
 - One 60" top no. WT6030 or
 - One 72" top no. WT7230
 - Order top separately (shown below)



- Model 69148 Includes:**
- Two 61303, 24" x 24" cabinets
 - One 72" top no. WT7230
 - Order top separately (shown below)

WORKSTATION COMPONENTS

Side/Back Retainer Set

- Four-inch high steel side/back stops attach to work tops for safety and damage protection.
- **Model 56607—For 60" work top**
- **Model 56608—For 72" work top**



Fixed Riser Shelf

- Stationary riser is made of heavy gauge steel.
- Shelf is 14" high by 9" deep.
- Has electrical knockouts.
- **Model 56601—Fits 60" work top**
- **Model 56721—Fits 72" work top**

Footrests

- Attach between work bench legs or between cabinet and legs.
- **Model 66606—Adjusts from 22" to 38⁵/₈"**
- **Model 66726—Adjusts from 38⁵/₈" to 66³/₈"**

Laminated Maple Work Surface

- Hardwood work surface is suitable for most any application.
- Welded butcher block construction with a smooth, maintenance free acrylic finish.
- **Model WT6030—60" W**
- **Model WT7230—72" W**

Adjustable Leg

- Adjusts in 1" increments from 27.5" to 40.125".
- **Model 66200**



MASTER No.	ITEM DESCRIPTION	WIDTH	DEPTH	HEIGHT	NET WT	SHIP WT	STORAGE	CAPACITY
61303	5-Drawer Cabinet	24"	24"	31 3/4"	146 lbs.	166 lbs.	11,767 cu. in.	1,100 lbs.
61703	6-Drawer Cabinet	24"	24"	35 5/8"	164 lbs.	184 lbs.	13,447 cu. in.	1,320 lbs.
66200	Adjustable Leg	4"	24"	27 1/2-40 1/8"	23 lbs.	25 lbs.	29,315 cu. in.	5,500 lbs.
WT6030	Maple Work Surface	60"	30"	1 3/4"	73 lbs.	75 lbs.	-	-
WT7230	Maple Work Surface	72"	30"	1 3/4"	96 lbs.	98 lbs.	-	-
56607	Side/Back Retainer Set	60"	30"	4"	11 lbs.	12.5 lbs.	-	-
56608	Side/Back Retainer Set	72"	30"	4"	12 lbs.	13.5 lbs.	-	-
56601	Fixed Riser Shelf	60"	9"	14"	27 lbs.	28 lbs.	-	-
56721	Fixed Riser Shelf	72"	9"	14"	28 lbs.	29 lbs.	-	-
66606	Adjustable Foot Rest	22-38 5/8"	2"	1 3/4"	5 lbs.	6 lbs.	-	-
66726	Adjustable Foot Rest	38 5/8-66 3/8"	2 1/4"	1 3/4"	8 lbs.	9 lbs.	-	-

Our hybrid modular system combines the economy of roller cabinet construction with modular cabinet features. Compact, high-density storage that saves space while it organizes parts, tools and supplies. Cabinets are stackable, can be fork-lifted or used as work stations. Cabinets can also be used as work station base cabinets, using two cabinets to support work surface or one cabinet with adjustable work station leg 66200 shown on page 38. Body made of 16 gauge steel; drawers of 18 gauge steel.

HMS™ SERIES MODULAR CABINETS

- 4" Drawers Have 130 lbs Capacity
- Larger Drawers Have 220 lbs Capacity
- One Drawer At A Time Interlocking System
- All Cabinets Include a MDF Work Surface
- Drawer Dividers Available, Sold Separately
- Comes With Label Strips, Lock and Two Keys
- MDF Work Surface Included



5 Drawer Cabinet
Model 40095



6 Drawer Cabinet
Model 40096



7 Drawer Cabinet
Model 40097

40095	DRS.	WIDTH	DEPTH	HEIGHT	CAPACITY
DRAWERS:	2	25"	18 1/2"	4"	130 lbs.
	2	25"	18 1/2"	6"	220 lbs.
	1	25"	18 1/2"	8"	220 lbs.

40096	DRS.	WIDTH	DEPTH	HEIGHT	CAPACITY
DRAWERS:	4	25"	18 1/2"	4"	130 lbs.
	2	25"	18 1/2"	6"	220 lbs.

40097	DRS.	WIDTH	DEPTH	HEIGHT	CAPACITY
DRAWERS:	7	25"	18 1/2"	4"	130 lbs.

MASTER No.	ITEM DESCRIPTION	WIDTH	DEPTH	HEIGHT	NET WT	SHIP WT	STORAGE	CAPACITY
40095	5-Drawer Cabinet	29"	20"	33 1/2"	144 lbs.	164 lbs.	12,950 cu. in.	920 lbs.
40096	6-Drawer Cabinet	29"	20"	33 1/2"	145 lbs.	165 lbs.	12,950 cu. in.	960 lbs.
40097	7-Drawer Cabinet	29"	20"	33 1/2"	149 lbs.	169 lbs.	12,950 cu. in.	910 lbs.

HMS™ Series Housing

- Custom design your own cabinet.
- Select any combination of drawer front heights that equal the usable height (28") of the cabinet.
- Model 40001

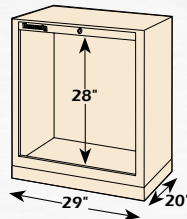

Housing Master No.	Dimensions (Inches)			Net Wt. Lbs.	Ship Wt. Lbs.
	Width	Depth	Height		
40001	29	20	33 1/2	87	90

HMS™ Series Drawers

- Constructed of 18 gauge steel.
- Drawers have bottom perforations and side wall divider slots for easy installation of divider sets.
- **Two-inch drawers cannot be divided.**
- Model Nos. 40002, 40004, 40006, 40008



Drawer Master No.	Dimensions (Inches)			Cu. In. Cap.	Load Cap.	Net Wt. Lbs.	Ship Wt. Lbs.
	Width	Depth	Height				
40002	25	18 1/2	2	925	120	11	12
40004	25	18 1/2	4	1,850	130	14	15
40006	25	18 1/2	6	2,775	220	16	17
40008	25	18 1/2	8	3,700	220	19	20

HMS™ Subdividers and Partitions

- Customize your HMS™ modular cabinet drawers.
- Partitions and subdividers are 3 1/2" high.



Subdivider	Length
99225	6 1/2
99265	8 1/8
99305	12
99325	12 3/4
Partition	Length
99020	18 1/2



Mobile Package

- Consists of tubular side handle and 6 x 2" locking caster set—two swivel, two rigid
- Adds 7 1/4" to height of cabinet
- Model 42010

Drawer Divider Sets for Hybrid Modular Cabinets

Drawer divider sets include partitions that fasten to drawer bottom and divide drawer into sections, plus subdividers that can be inserted into slots to form compartments. Partitions and subdividers are 3 1/2" high.

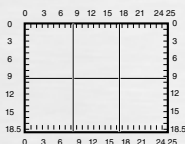

42001
6 Comp.
8.3" x 9.25"

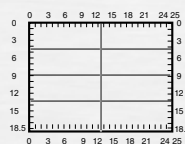

42002
8 Comp.
12.5" x 4.6"

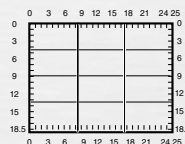

42003
12 Comp.
8.3" x 4.6"

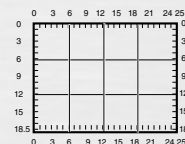

42004
12 Comp.
6.2" x 6.1"

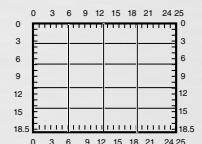

42005
20 Comp.
6.2" x 3.6"

Mobile modular cabinets make taking your tools to the job site easy and convenient. And, you get high density storage, too. Order our pre-engineered models or custom design your own from the housings and drawers listed below. All models are shipped assembled. Divider sets and accessories available.

24" x 24" MOBILE MODULAR STORAGE SYSTEMS

- NS Latching Drawers With Ball-Bearing Slides: 220 Lbs Capacity Per Drawer
- Vinyl Top Mat, 2 Vinyl Side Handles, And 5 x 1 1/2" Casters
- High Security Tubular Locking System With 2 Keys

61203	DRS.	WIDTH	DEPTH	HEIGHT	CAPACITY
DRAWERS:	2	20 1/2"	20 1/2"	2"	220 lbs.
	1	20 1/2"	20 1/2"	4"	220 lbs.
	1	20 1/2"	20 1/2"	6"	220 lbs.
	1	20 1/2"	20 1/2"	8"	220 lbs.

61750	DRS.	WIDTH	DEPTH	HEIGHT	CAPACITY
DRAWERS:	2	20 1/2"	20 1/2"	3"	220 lbs.
	4	20 1/2"	20 1/2"	4"	220 lbs.
	2	20 1/2"	20 1/2"	5"	220 lbs.

MASTER No.	ITEM DESCRIPTION	WIDTH	DEPTH	HEIGHT	NET WT	SHIP WT	STORAGE
61203	5-Drawer Cabinet	24"	24"	25 3/8"	165 lbs.	185 lbs.	9,245 cu. in.
61750	8-Drawer Cabinet	24"	24"	42 3/8"	221 lbs.	241 lbs.	13,447 cu. in.



24" x 24" MOBILE MODULAR HOUSING

- Can Be Filled With NS Latching Drawers Only
- Vinyl Top Mat, 2 Vinyl Side Handles, And 5 x 1 1/2" Casters
- High Security Tubular Locking System With 2 Keys

Model 61290
Usable height 22"

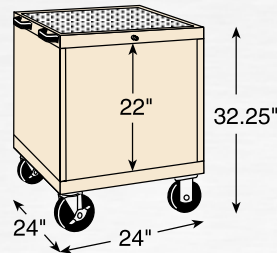

HOUSING	ITEM DESCRIPTION	WIDTH	DEPTH	HEIGHT	NET WT	SHIP WT	STORAGE
61290	26" Tall Housing	24"	24"	25 3/8"	83 lbs.	93 lbs.	14,745 cu. in.
61759	42" Tall Housing	24"	24"	42 3/8"	97 lbs.	107 lbs.	24,422 cu. in.

DRAWERS	ITEM DESCRIPTION	WIDTH	DEPTH	HEIGHT	NET WT	SHIP WT	STORAGE
51902	Latching Drawer	26"	26"	2"	10 lbs.	11 lbs.	1,352 cu. in.
51903	Latching Drawer	26"	26"	3"	11 lbs.	12 lbs.	2,028 cu. in.
51904	Latching Drawer	26"	26"	4"	23 lbs.	14 lbs.	2,704 cu. in.
51905	Latching Drawer	26"	26"	5"	13.5 lbs.	14.5 lbs.	3,380 cu. in.
51906	Latching Drawer	26"	26"	6"	14 lbs.	15 lbs.	4,056 cu. in.
51907	Latching Drawer	26"	26"	7"	14.5 lbs.	15.5 lbs.	4,732 cu. in.
51908	Latching Drawer	26"	26"	8"	15 lbs.	16 lbs.	5,408 cu. in.

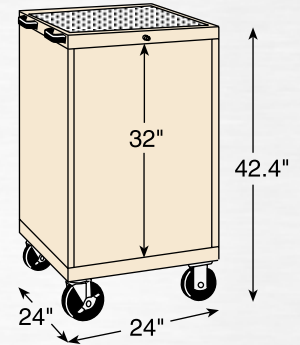

Model 61759
Usable height 32"

30" x 30" MOBILE MODULAR STORAGE SYSTEMS

- NX Latching Drawers With Ball-Bearing Slides: 220 Lbs Capacity Per Drawer
- Vinyl Top Mat, 2 Vinyl Side Handles, And 5 x 1 1/2" Casters
- High Security Tubular Locking System With 2 Keys

63350	DRS.	WIDTH	DEPTH	HEIGHT	CAPACITY
DRAWERS:	2	26"	26"	3"	220 lbs.
	2	26"	26"	4"	220 lbs.
	1	26"	26"	6"	220 lbs.
	1	26"	26"	8"	220 lbs.

MASTER No.	ITEM DESCRIPTION	WIDTH	DEPTH	HEIGHT	NET WT	SHIP WT	STORAGE
63350	5-Drawer Cabinet	30"	30"	38 1/2"	283 lbs.	303 lbs.	18,928 cu. in.



30" x 30" MOBILE MODULAR HOUSING

- Can Be Filled With NX Latching Drawers Only
- Vinyl Top Mat, 2 Vinyl Side Handles, And 5 x 1 1/2" Casters
- High Security Tubular Locking System With 2 Keys

HOUSING	ITEM DESCRIPTION	WIDTH	DEPTH	HEIGHT	NET WT	SHIP WT	STORAGE
63359	7-Drawer Housing	30"	30"	38 1/2"	305 lbs.	325 lbs.	25,200 cu. in.

DRAWERS	ITEM DESCRIPTION	WIDTH	DEPTH	HEIGHT	NET WT	SHIP WT	STORAGE
63902	Latching Drawer	26"	26"	2"	18 lbs.	19 lbs.	1,352 cu. in.
63903	Latching Drawer	26"	26"	3"	19 lbs.	20 lbs.	2,028 cu. in.
63904	Latching Drawer	26"	26"	4"	21 lbs.	22 lbs.	2,704 cu. in.
63905	Latching Drawer	26"	26"	5"	21.5 lbs.	22.5 lbs.	3,380 cu. in.
63906	Latching Drawer	26"	26"	6"	22 lbs.	23 lbs.	4,056 cu. in.
63907	Latching Drawer	26"	26"	7"	22.5 lbs.	23.5 lbs.	4,732 cu. in.
63908	Latching Drawer	26"	26"	8"	23 lbs.	24 lbs.	5,408 cu. in.

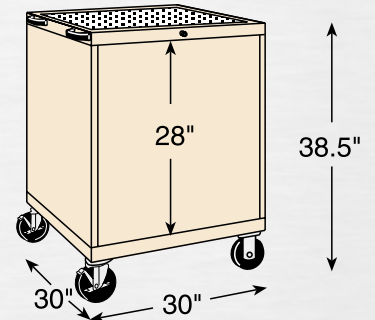

Model 63359
Usable height 28"

Use partitions to divide drawers in sections. Insert subdividers to make compartments. Partitions fasten to drawer bottom with screw and can be fitted from front to back or side to side. Subdividers slide into slots in partitions and side walls. Slots are .79" (20mm) apart.

DRAWER PARTITIONS & SUBDIVIDERS

PARTITION LENGTH	SPACES	2" FRONT	3" FRONT	4" FRONT
20.35" (517mm)	26	99032	99033	99034
25.87" (657mm)	33	99042	99043	99044
40.15" (1020 mm)	51	-	99053	99054

Note: Taller partitions and subdividers for use with higher side walls (drawer height extensions) are available. Contact your Kennedy distributor for more information.

SUBDIVIDER LENGTH	SPACES	2" FRONT	3" FRONT	4" FRONT
1.42" (36mm)	2	99505	99103	99104
2.02" (56mm)	3	99122	99123	99124
2.99" (76mm)	4	99503	99143	99144
3.78" (96mm)	5	99162	99163	99164
4.57" (116mm)	6	99182	99183	99184
5.35" (136mm)	7	99202	99203	99204
6.14" (156mm)	8	99222	99223	99224
6.93" (176mm)	9	99242	99243	99244
7.72" (196mm)	10	99262	99263	99264
8.50" (216mm)	11	99282	99283	99284
9.29" (236mm)	12	99289	99290	99291
10.08" (256mm)	13	99302	99303	99304
12.44" (316mm)	16	99322	99323	99324
13.23" (336mm)	17	99342	99343	99344



Plastic Groove Trays

A simple way to store reamers, taps and drill bits. Trays clip together. Made of black polystyrol. Fits 2" or taller drawers.



Plastic Groove Trays are 6.25" W x 6.25" D x 1.375"H.

PLASTIC GROOVE TRAYS

No. of Grooves/ Groove Width	Order No.
2 grooves/2.875"	96002
3 grooves/1.875"	96003
4 grooves/1.375"	96004

TRAY DIVIDERS

Divider Size	Order No.
2 grooves/2.875"	96005
3 grooves/1.875"	96006
4 grooves/1.375"	96007

Plastic Boxes

Hold small parts and electronic components. Available in three sizes. Fits 3" or taller drawers. Can be clipped together in any combination. Made of black polystyrol.



Box Size	Order No.
2.5"W x 2.5"D x 2.25"H	96022
2.5"W x 5"D x 2.25"H	96025
6.25"W x 6.25"D x 2.25"H	96066
Bin Divider for 6.25" x 6.25" Bin	96008

Plastic Box Sets for 30" x 30" Modular Cabinets

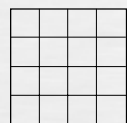

96016
16 Boxes
6.25" x 6.25"

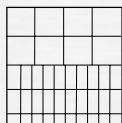

96038
8 Boxes - 6.25" x 6.25"
20 Boxes - 2.5" x 5"
10 Boxes - 2.5" x 2.5"

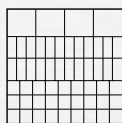

96055
4 Boxes - 6.25" x 6.25"
24 Boxes - 2.5" x 5"
27 Boxes - 2.5" x 2.5"

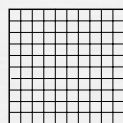

96100
100 Boxes
2.5" x 2.5"



96024
24 Boxes
6.25" x 6.25"



96035
20 Boxes - 6.25" x 6.25"
15 Boxes - 2.5" x 5"

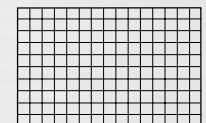

96150
150 Boxes
2.5" x 2.5"

Plastic Box Sets for 30" x 24" Modular Cabinets



96012
12 Boxes
6.25" x 6.25"

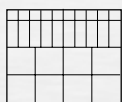

96028
8 Boxes - 6.25" x 6.25"
10 Boxes - 2.5" x 5"
10 Boxes - 2.5" x 2.5"

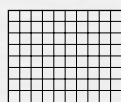

96080
80 Boxes
2.5" x 2.5"

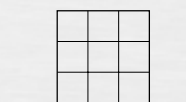

96009
9 Boxes
6.25" x 6.25"

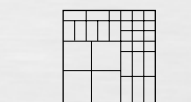

96030
4 Boxes - 6.25" x 6.25"
13 Boxes - 2.5" x 5"
13 Boxes - 2.5" x 2.5"

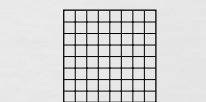

96064
64 Boxes
2.5" x 2.5"

Plastic Box Sets for 24" x 24" Modular Cabinets



Adjustable Shelf

- Adjustable support brackets allow shelf location to be easily changed.

Pull Out Shelf with Drawer Handle

- Safety feature, lock-out pin prevents shelf from moving back inside the cabinet until the pin is released.

Bottom Shelf

- Turns cavity in bottom of cabinet into easy access storage area.



Pull Out Shelf with Gussets

- For use in cabinets with doors.
- Features safety lock-out pin mechanism.



Modular Cabinet Doors

- Secure expensive tools and supplies behind a locking door.
- Comes with attachment hardware and lock/key set.
- Pull out shelf with gussets must be used instead of standard drawer with drawer pull in order for door to close.

Master No.	Fits Housing No./Size	Net Wt. Lbs.	Ship Wt. Lbs.
63680	63600, 30" x 30" x 59.5"	35	36
63480	63400, 30" x 30" x 39.6"	25	26
63380	63300, 30" x 30" x 31.7"	22	23
62580	62500, 30" x 24" x 49.6"	30	31
62780	62700, 30" x 24" x 35.6"	23	24
64680	64600, 44" x 30" x 59.5"	47	48
64480	64400, 44" x 30" x 39.6"	34	35
61280	61200, 24" x 24" x 25.6"	16	17
61380	61300, 24" x 24" x 31.7"	18	20
61480	61400, 24" x 24" x 39.6"	22	23
61580	61500, 24" x 24" x 49.6"	26	27
61780	61700, 24" x 24" x 35.6"	20	21

Drawer Height Extensions

- Removable drawer insert raises sidewall height to match drawer front.
- Slotted sides allow use of taller partitions and subdividers.

Master No.	Housing Size/Drawer Front Height	Net Wt. Lbs.	Ship Wt. Lbs.
91066	24" x 24"/6"	3	4
91067	24" x 24"/8"	3	4
91068	24" x 24"/10"	4	5
91069	24" x 24"/12"	6	7
91070	30" x 30"/6"	3	4
91071	30" x 30"/8"	4	5
91072	30" x 30"/10"	5	6
91073	30" x 30"/12"	7	8
91074	30" x 24"/6"	3	4
91075	30" x 24"/8"	4	5
91076	30" x 24"/10"	5	6
91077	30" x 24"/12"	7	6
91078	44" x 30"/6"	7	8
91079	44" x 30"/8"	9	10
91080	44" x 30"/10"	11	12

Master No.	Fork Lift Base Description	Net Wt. Lbs.	Ship Wt. Lbs.
99616	For 24" x 24" Cabinets	21	22
99626	For 30" x 24" Cabinets	29	30
99636	For 30" x 30" Cabinets	26	27
99646	For 44" x 30" Cabinets	35	36

Master No.	Pallet Truck Base Description	Net Wt. Lbs.	Ship Wt. Lbs.
99716	For 24" x 24" Cabinets	13	14
99726	For 30" x 24" Cabinets	29	30
99736	For 30" x 30" Cabinets	34	35
99746	For 44" x 30" Cabinets	35	36

- ### Panel Brace Support
- Includes one brace and mounting hardware.
 - 37 1/2" W x 3" D x 1" H.
 - Net Wt. 5 lbs.
 - Ship Wt. 5.5 lbs.
 - Model 50050

Two 50050 braces with panel set 50002TX (Back view).

Master No.	Description	Cu. In. Cap.	Load Cap.	Net Wt. Lbs.	Ship Wt. Lbs.
63202	Adj Shelf for 30" x 30" Cabinet			15	16
64202	Adj Shelf for 44" x 30" Cabinet			23	24
62202	Adj Shelf for 30" x 24" Cabinet			12	13
61202	Adj Shelf for 24" x 24" Cabinet			10	11
63302	Pull Out Shelf for 30" x 30" Cab		550	20	21
64302	Pull Out Shelf for 44" x 30" Cab		550	28	29
62302	Pull Out Shelf for 30" x 24" Cab		550	16	17
61302	Pull Out Shelf for 24" x 24" Cab		220	13	14
63305	Pull Out Shelf with Gussets for 30" x 30" Cab		550	20	21
64305	Pull Out Shelf with Gussets for 44" x 30" Cab		550	28	29
62305	Pull Out Shelf with Gussets for 30" x 24" Cab		550	16	17
61305	Pull Out Shelf with Gussets for 24" x 24" Cab		220	13	14
99001	Bottom Shelf for 30" x 30" Cab			19	20
99004	Bottom Shelf for 44" x 30" Cab			29	30
99003	Bottom Shelf for 30" x 24" Cab			15	16
99002	Bottom Shelf for 24" x 24" Cab			12	13

Panel Brace Supports

Braces attach to work station and toolboard panels. Two brace supports are required per two panel set.



Bottom Support Brackets

- Secures up to five NC/CNC tool trays into drawer. (Tool trays shown below).
- Bolts to drawer bottom.
- Set includes two brackets and hardware.

Master No.	Bottom Support Brackets	Dimensions (Inches) Length Height	Net Wt. Lbs.	Ship Wt. Lbs.
99541	For 30" x 30" Cabinet	25.6 3.5	6.5	7
99543	For 30" x 30" Cabinet	25.6 5	9	9.5
99540	For 30" x 24" Cabinet	20 3.5	4.5	5
99542	For 30" x 24" Cabinet	20 5	7	7.5



Angle Brackets

- Includes one left hand and one right hand angle bracket and mounting hardware.
- 6" W x 8" D x 4.5" H.
- Net Wt. .4 lbs. Ship Wt. 1 lbs.
- Model 50054

Fork Lift Bases

- Bolt easily onto cabinet.
- Come with front covers.
- Height, 2.4"H.

Pallet Truck Bases

- Bolt easily onto cabinet.
- Come with front covers.
- Height, 4"H.



NC/CNC PLASTIC SOCKETS

Kennedy plastic sockets are of high quality, break resistant plastic. Shockproof ABS plastic sockets firmly support and protect tool holder shanks. Sockets are available for standard tapers, Morse tapers and straight shank tool holders. All plastic sockets are available in red only.



70059 socket for #30 taper tool holders. Also Cat V#3, Morse 3. Up to seven sockets will fit 70060 tool tray.

70067 socket for #35 taper tool holders. Also, Cat V#3, Morse 4. Up to seven sockets will fit 70060 tool tray.

70051 socket for #40 taper tools. Also, Cat V#4. Up to seven sockets will fit 70060 tool tray.

70052 socket for #45 taper tools. Also, Morse 5. Up to six sockets will fit 70060 tool tray.

70053 socket for #50 taper tool holders. Also, Cat V#5. Up to five sockets will fit 70060 tool tray.



70100 socket for straight shank tools up to 1.2" dia. (30 mm). Up to ten sockets will fit 70060 tool tray.

70064 socket for straight shank tools up to 1.4" dia. (36 mm) TR36. Up to seven sockets will fit 70060 tool tray.

70063 socket for straight shank tools up to 1.5" dia. (40 mm). Up to seven sockets will fit 70060 tool tray.

70056 socket for straight shank tools up to 1.75" dia. (44.4 mm). Up to six sockets will fit 70060 tool tray.

70065 socket for straight shank tools up to 1.97" dia. (50 mm). Up to six sockets will fit 70060 tool tray.

70057 socket for straight shank tools up to 2" dia. (50.8 mm). Up to six sockets will fit 70060 tool tray.

70066 socket for straight shank tools up to 2.4" dia. (60 mm). Up to six sockets will fit 70060 tool tray.

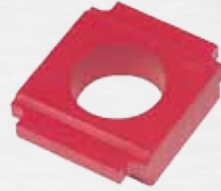

Kennametal KM® Plastic Sockets

70030 KM32
1.75" W x 4" D x 1"H
Up to 8 will fit a tray

70031 KM40
1.75" W x 4" D x 1"H
Up to 8 will fit a tray

70032 KM50
3.25" W x 4" D x 1"H
Up to 6 will fit a tray

70033 KM63
3.25" W x 4" D x 1"H
Up to 6 will fit a tray

Sandvik Capto™ System Plastic Sockets

71103 C3
1.75" W x 4" D x 1"H
Up to 8 will fit a tray

71104 C4
1.75" W x 4" D x 1"H
Up to 8 will fit a tray

71105 C5
3.25" W x 4" D x 1"H
Up to 6 will fit a tray

71106 C6
3.25" W x 4" D x 1"H
Up to 6 will fit a tray

71108 C8
3.25" W x 4" D x 1"H
Up to 6 will fit a tray



HSK-A System Sockets

70020 HSKA 25
1.75" W x 4" D x 1"H
Up to 8 will fit a tray

70021 HSKA 32
1.75" W x 4" D x 1"H
Up to 8 will fit a tray

70022 HSKA 40
1.75" W x 4" D x 1"H
Up to 8 will fit a tray

70023 HSKA 50
3.25" W x 4" D x 1"H
Up to 6 will fit a tray

70024 HSKA 63
3.25" W x 4" D x 1"H
Up to 6 will fit a tray

70025 HSKA 80
3.25" W x 4" D x 1"H
Up to 6 will fit a tray

70026 HSKA 100
Fits Tray 70070 only
4" W x 4" D x 1"H
Up to 5 will fit a tray

70027 HSKA 125
Fits Tray 70070 only
5.3" W x 4" D x 1"H
Up to 4 will fit a tray

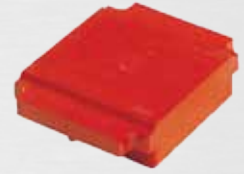

70090 socket without holes, for special sized tools. Holes up to 1.2" can be drilled. Up to eight sockets will fit 70060 tool tray.

70092 socket without holes, for special sized tools. Holes up to 2.25" can be drilled. Up to six sockets will fit 70060 tool tray.

70094 socket without holes, for special sized tools. Holes up to 3.5" can be drilled. Up to five sockets will fit 70070 tool tray.

70096 socket without holes, for special sized tools. Holes up to 3.7" can be drilled. Up to four sockets will fit 70070 tool tray.

Plastic sockets are designed to secure and protect Modular Quick Change Units



It is highly recommended that modular cabinets be bolted to the floor to prevent tipping and serious injury.

Machine Cabinets can be custom-designed. The example at the right includes:

- Model 63400 30" x 30" modular cabinet housing
- Model 63302 pull-out shelf
- One 4" drawer and two 12" drawers
- Four 76209 socket partitions
- Plastic sockets



The CutterKart™

Pre-configured CutterKarts come with four metal and ABS plastic tool holder plates. Made of 18 gauge steel.

CutterKart™ Facts and Features:

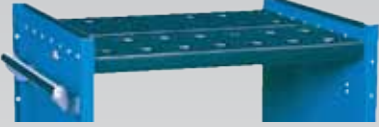

Includes four metal and ABS plastic toolholder plates.



5 x 2" roller bearing casters, two rigid and two swivel with brakes, roll across the roughest floors with ease.



- Pre-configured trolley holds up to 56 #40 taper tools.
- Weight capacity of 1,200 lbs.
- **Model 73240**

- Pre-configured trolley holds up to 40 #50 taper tools.
- Weight capacity of 1,200 lbs.
- **Model 73250**

Master No.	Dimensions (Inches)			Load Cap.	Net Wt. Lbs.	Ship Wt. Lbs.
	Width	Depth	Height			
73240	29	24	38	1,200	80	86
73250	29	24	38	1,200	80	86

The ToolKart™

Pre-configured ToolKarts come with six frames and plastic sockets. Additional tool frames, plastic sockets and trolley accessories must be added separately. Made of 18 gauge steel.

ToolKart™ Facts and Features:

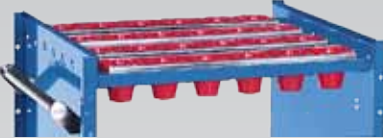

ToolKarts include sturdy metal socket frames that hold a variety of sockets. Order pre-configured cart and add additional socket frames and toolholders as your storage requirements change. Or, custom-design your own ToolKart™.



5 x 2" roller bearing casters, two rigid and two swivel with brakes, roll across the roughest floors with ease.



- Pre-configured trolley holds up to 42 #30 taper tools.
- **Model 73030**

- Pre-configured trolley holds up to 42 #40 taper tools.
- **Model 73040**

- Pre-configured trolley holds up to 36 #50 taper tools.
- **Model 73050**

- ToolKart only.
- Includes tubular end handle and 5 x 2" roller bearing caster set.
- **Model 72001**



- Sturdy socket frame bolts to end walls of ToolKart.
- Holds up to 11 #30 taper tools.
- **Model 70062**

Master No.	Dimensions (Inches)			Load Cap.	Net Wt. Lbs.	Ship Wt. Lbs.
	Width	Depth	Height			
73030	29	24	38	1,200	80	86
73040	29	24	38	1,200	80	86
73050	29	24	38	1,200	80	86
72001	29	24	38	1,200	9	10
70062				1,200	3	3.3



Product #	Description	Page #	Product #	Description	Page #	Product #	Description	Page #
1022	22" Cantilever Tool Box	20	50054	Angle Brackets	43	64116	FX Drawers For 44x30 Modular Cabinets	38
10350	Storage Cabinet	28	50067	Single Sided 2-Panel Toolboard		64202	Adjustable Shelf	43
10351	Storage Cabinet Shelf	28		With Frame	27	64302	Pull Out Shelf	43
10490	Pro-Line Canopy	16	50068	Single Sided 3-Panel Toolboard		64305	Pull Out Shelf W/ Gussets	43
10491	Pro-Line 39" 7-Drawer Maintenance Cart	16		With Frame	27	64400	44 X 30 Modular Cabinet Housing	37
10492	Pro-Line 39" 13-Drawer Maintenance Cart	16	50070	Single Sided 2-Panel Benchmark Toolboard With Frame	27	64404	44 x 30 6-Drawer Modular Cabinet	38
10493	Pro-Line 39" 12-Drawer Maintenance Cart	16	50081	Toolboard System 5" x 1 1/4" Mobile Package	27	64408	44 x 30 10-Drawer Modular Cabinet	37
10494	Pro-Line 41" 12-Drawer Maintenance Cart	16	50083	Toolboard System 3 1/2" x 1 1/4" Mobile Package	27	64410	44 x 30 7-Drawer Modular Cabinet	37
10495	Pro-Line 41" 12-Drawer Maintenance Cart	16	50100	Open Tool Trolley	26	64480	Modular Cabinet Doors	43
182X	2-Shelf Locker (BB)	12	50102	Open Tool Trolley With Hook Set	26	64600	44 X 30 Modular Cabinet Housing	38
185	5-Drawer Side Cabinet	13	50104	Open Tool Trolley Without Hook Set	26	64606	44 x 30 13-Drawer Modular Cabinet	37
185X	5-Drawer Side Cabinet (BB)	13	50230	Wall Mounted Cabinet Without Panels	28	64608	44 x 30 10-Drawer Modular Cabinet	37
20200	Benchmark Series 6-Drawer Cabinet	5	50260	Wall Mounted Cabinet	28	64610	44 x 30 6-Drawer Modular Cabinet	37
202X	2-Shelf Locker (BB)	12	50301	Mini Workshop Cabinet	28	64680	Modular Cabinet Doors	43
205	5-Drawer Side Cabinet	13	51002-10	NX Drawers For 24x24 Modular Cabinets	32	66200	Adjustable Legs	39
205X	5-Drawer Side Cabinet (BB)	13	51012	NX Drawers For 24x24 Modular Cabinets	32	66606	Footrest	39
21040	34" 4-Drawer Cabinet: High Security Lock	12	51014	NX Drawers For 24x24 Modular Cabinets	32	66726	Footrest	39
21041	34" 4-Drawer Cabinet: Combination Lock	12	51016	NX Drawers For 24x24 Modular Cabinets	32	69104	Modular Work Station	39
21042	34" 4-Drawer Cabinet: Electronic Lock	12	5150	2-Drawer Machinists' Chest Base	19	69146	Modular Work Station	39
220	2-Drawer Portable Chest	20	51902-08	Latching Drawers for Mobile Modular Cabinet	41	69148	Modular Work Station	39
2600	Chest Riser	18	520	7-Drawer Machinists' Chest	19	70020-71108	NC/CNC Plastic Sockets	44
2602	2-Drawer Mechanic's Chest Base	18	52103-10	FX Drawers For 30x24 Modular Cabinets	33	70062	Socket Frame	45
2603	3-Drawer Mechanic's Chest Base	18	52112	FX Drawers For 30x24 Modular Cabinets	33	72001	ToolKart	45
2604	4-Drawer Mechanic's Chest Base	18	52114	FX Drawers For 30x24 Modular Cabinets	33	73030	ToolKart	45
263	3-Drawer Mechanic's Chest	18	52116	FX Drawers For 30x24 Modular Cabinets	33	73040	ToolKart	45
266	6-Drawer Mechanic's Chest	18	5220	20" All-Purpose Tool Box	20	73050	ToolKart	45
2705X	27" 5-Drawer Mechanics Chest (BB)	18-19	526	8-Drawer Machinists' Chest	19	73240	CutterKart	45
273	27" 3-Drawer Cabinet	11	52611	11-Drawer Machinists' Chest	19	73250	CutterKart	45
273X	27" 3-Drawer Cabinet (BB)	11	53000	Benchmark Series 53" 7-Drawer Chest	4	76209	Socket Partition	34
275	27" 5-Drawer Cabinet	11	53001	Benchmark Series 53" 11-Drawer Cabinet	4	99020	Hybrid Drawer Partition	40
275X	27" 5-Drawer Cabinet (BB)	11	5300MP	Maintenance Pro Series 53" 12-Drawer Cart	7	91066-80	Drawer Height Extenders	43
277	27" 7-Drawer Cabinet	11	5302MP	Maintenance Pro Series 53" 8-Drawer Chest	7	91102-91344	Dr Divider Sets for 24x24 Modular Cabinets	32
277X	27" 7-Drawer Cabinet (BB)	11	53101	Benchmark Series 53" Canopy	4	92122-92744	Dr Divider Sets for 30x24 Modular Cabinets	33
2805X	29" 5-Drawer Mechanics Chest (BB)	19	5350MP	Maintenance Pro Series 53" Canopy	7	93102-93774	Dr Divider Sets for 30x30 Modular Cabinets	36
285X	27" 5-Drawer Mechanics Chest (BB)	19	56601	Fixed Riser Shelf (60" Work Top)	39	95213-95644	Dr Divider Sets for 44x30 Mod Cabinets	38
286X	6-Drawer Bench Cabinet	22	56607	Side/Back Retainer Set (60" Work Top)	39	96002-07	Plastic Groove Trays/Dividers	42
2905X	29" 5-Drawer Mechanics Chest (BB)	18-19	56608	Side/Back Retainer Set (72" Work Top)	39	96008-150	Plastic Boxes/Box Sets	42
2907MP	Maintenance Pro Series 29" 7-Drawer Cabinet	8	56721	Fixed Riser Shelf (72" Work Top)	39	99001-04	Bottom Shelf	43
2912MP	Maintenance Pro Series 29" 12-Drawer Top Chest	8	5804MP	Maintenance Pro Series 58" 12-Drawer Cart	8	99032-34	Partitions	42
2905MP	Maintenance Pro Series 29" 5-Drawer Top Chest	8	60000	Benchmark Series 60" 7-Drawer Chest	4	99042-44	Partitions	42
28085	5-Drawer Stainless Steel Cabinet	30	6006	60" 6-Drawer Versa-Bench	23	99053-54	Partitions	42
28087	7-Drawer Stainless Steel Cabinet	30	60101	60" 6-Drawer Versa-Bench	23	99103-04	Subdividers	42
2812	12-Drawer Mechanic's Chest	18	60121	Benchmark Series 60" Top Canopy	4	99122-24	Subdividers	42
28197	7-Drawer Stainless Steel Cabinet	30	6012E	Benchmark Series 60" 11-Drawer Cabinet	4	99143-44	Subdividers	42
285	27" 5-Drawer Mechanics Chest	18-19	6012S	60" 12-Drawer Versa-Bench	23	99162-64	Subdividers	42
29000	Cabinet Plastic Work Surface	30	63002-06	12-Drawer Versa-Bench	23	99182-84	Subdividers	42
2902	2-Drawer Mechanic's Chest Base	18	61202	NX Drawers For 30x30 Modular Cabinets	36	99202-04	Subdividers	42
295	29" 5-Drawer Cabinet	11	61203	Adjustable Shelf	43	99222-24	Subdividers	42
295X	29" 5-Drawer Cabinet (BB)	11	61280	24 X 24 5-Drawer Mobile Modular Cabinet	41	99225	Hybrid Drawer Subdivider	40
297	29" 7-Drawer Cabinet	11	61280	Modular Cabinet Doors	43	99242-44	Subdividers	42
297X	29" 7-Drawer Cabinet (BB)	11	61290	24 X 24 Mobile Modular Cabinet Housing	41	99262-64	Subdividers	42
300MP	Maintenance Pro Series 2-Shelf Side Locker	8	61300	24 X 24 Modular Cabinet Housing	32	99265	Hybrid Drawer Subdivider	40
302X	Industrial Series 2-Shelf Side Locker (BB)	12	61302	Pull Out Shelf	43	99282-84	Subdividers	42
3905MP	Maintenance Pro Series 39" 5-Drawer Chest	9	61303	24 X 24 5-Drawer Modular Cabinet	32	99289-91	Subdividers	42
305X	Industrial Series 5-Drawer Maintenance Chest (BB)	14	61305	Pull Out Shelf W/ Gussets	43	99302-04	Subdividers	42
306MP	Maintenance Pro Series 6-Drawer Side Cabinet	8	61380	Modular Cabinet Doors	43	99305	Hybrid Drawer Subdivider	40
306X	Industrial Series 6-Drawer Side Cabinet (BB)	13	61400	24 X 24 Modular Cabinet Housing	32	99322-24	Subdividers	42
310X	Industrial Series 10-Drawer Maintenance Cart (BB)	14	61407	24 X 24 7-Drawer Modular Cabinet	32	99325	Hybrid Drawer Subdivider	40
315X	Industrial Series 15-Drawer Maintenance Cart (BB)	14	61480	Modular Cabinet Doors	43	99342-44	Subdividers	42
3400MP	Maintenance Pro Series 34" 5-Drawer Chest	7	61500	24 X 24 Modular Cabinet Housing	32	99503	Subdividers	42
3407MP	Maintenance Pro Series 34" 7-Drawer Cabinet	7	61509	24 X 24 9-Drawer Modular Cabinet	32	99505	Subdividers	42
3412MP	Maintenance Pro Series 34" 12-Drawer Chest	7	61580	Modular Cabinet Doors	43	99540-43	Bottom Support Brackets	43
348X	Industrial Series 34" 8-Drawer Cabinet (BB)	12	61700	24 X 24 Modular Cabinet Housing	32	99616-46	Fork Lift Base	43
360	10-Drawer Mechanic's Chest	18	61703	24 X 24 6-Drawer Modular Cabinet	32	99716-46	Pallet Truck Base	43
3611	11-Drawer Machinists' Chest	19	61750	24 X 24 8-Drawer Mobile Modular Cabinet	41	99814	Red Magnetic Sheets	27
376X	Industrial Series 27" 6-Drawer Cabinet (BB)	11	61759	24 X 24 Mobile Modular Cabinet Housing	41	99815	Blue Magnetic Sheets	27
378X	Industrial Series 27" 8-Drawer Cabinet (BB)	12	61780	Modular Cabinet Doors	43	99816	White Magnetic Sheets	27
380MP	Maintenance Pro Series 2-Shelf Side Locker	8	620	3-Drawer Machinists' Chest	19	99817	Yellow Magnetic Sheets	27
382MP	Maintenance Pro Series 6-Drawer Side Cabinet	8	62202	Adjustable Shelf	43	99820-25	Single Hook Toolholder	29
382X	Industrial Series 2-Shelf Locker (BB)	12	62302	Pull Out Shelf	43	99827-30	Double Hook Toolholder	29
386X	Industrial Series 6-Drawer Side Cabinet (BB)	13	62305	Pull Out Shelf W/ Gussets	43	99831-32	Plier Hook Toolholder	29
3900MP	Maintenance Pro Series 39" 8-Drawer Cabinet	9	62400	30 X 24 Modular Cabinet Housing	33	99833-36	Single Spring Clip Toolholder	29
39100MP	Maintenance Pro Series 39" Canopy	9	62407	30 X 24 7-Drawer Modular Cabinet	33	99839	Rink Hook Toolholder	29
40002-08	Drawer For Hybrid Modular Cabinets	40	62500	30 X 24 Modular Cabinet Housing	33	99840	Screwdriver Toolholder	29
40095	5-Drawer Hybrid Modular Cabinet	40	62509	30 X 24 9-Drawer Modular Cabinet	33	99841	Wrench Rack Toolholder	29
40096	6-Drawer Hybrid Modular Cabinet	40	62580	Modular Cabinet Doors	43	99842	Allen Key Toolholder	29
40097	7-Drawer Hybrid Modular Cabinet	40	62600	30 X 24 Modular Cabinet Housing	33	99847	Parts Shelf Toolholder	29
40200	Benchmark Series Full-Height Side Locker	5	62610	30 X 24 10-Drawer Modular Cabinet	33	99848	Plastic Bin Storage Strip Toolholder	29
415	5-Drawer Versa Cart	13	62780	Modular Cabinet Doors	43	99851	10 Pc Toolholder Set	29
415X	5-Drawer Versa Cart (BB)	13	63008	NX Drawers For 30x30 Modular Cabinets	36	99852	30 Pc Toolholder Set	29
435	5-Drawer Versa Cart	13	63103-10	FX Drawers For 30x30 Modular Cabinets	36	99853	60 Pc Toolholder Set	29
435X	5-Drawer Versa Cart (BB)	13	63112	FX Drawers For 30x30 Modular Cabinets	36	99876	Cable Loop Hook Toolholder	29
4200MP	Maintenance Pro Series 42" 12-Drawer Cart	7	63114	FX Drawers For 30x30 Modular Cabinets	36	D026	Security Door	24
4202MP	Maintenance Pro Series 42" 7-Drawer Chest	7	63116	FX Drawers For 30x30 Modular Cabinets	36	DR264X	4 Drawer Package	24
42001	Dr Divider Sets for Hybrid Mod Cabinets	40	63202	Adjustable Shelf	43	DR265X	5 Drawer Package	24
42002	Dr Divider Sets for Hybrid Mod Cabinets	40	63302	Pull Out Shelf	43	DS1	Fold Away Cabinet Shelf	12
42003	Dr Divider Sets for Hybrid Mod Cabinets	40	63303	30 x 30 x 40 4-Drawer Machine Cabinet	34	K20	20" Tool Box	20
42004	Dr Divider Sets for Hybrid Mod Cabinets	40	63305	Pull Out Shelf W/ Gussets	43	K24	24" Tool Box	20
42005	Dr Divider Sets for Hybrid Mod Cabinets	40	63350	30 X 30 5-Drawer Mobile Modular Cabinet	41	MC22	2 Drawer Machinists' Chest Base	19
42010	Mobile Package For Hybrid Mod Cabinets	40	63359	30 X 30 Mobile Modular Cabinet Housing	41	MC28	2 Drawer Machinists' Chest Base	19
4410MP	Maintenance Pro Series 44" 5-Drawer Chest	9	63380	Modular Cabinet Doors	43	SS405X	5 Drawer Work Station Steel Top	24
46000	Benchmark Series 46" 8-Drawer Chest	4	63400	30 X 30 Modular Cabinet Housing	36	SS410X	10 Drawer Work Station Steel Top	24
46003	Benchmark Series 46" 11-Drawer Cabinet	4	63405-12	30 x 30 x 40 Modular Cabinets	36	TS261X	1 Drawer Tool Stand	24
46101	Benchmark Series 46" Canopy	4	63416-19	30 x 30 x 40 Modular Cabinets	36	TS265X	5 Drawer Tool Stand	24
4804	4-Drawer Versa-Bench	22	63480	Modular Cabinet Doors	43	VBLEG	Stationary Legs	22
4806	6-Drawer Versa-Bench	22	63600	30 X 30 Modular Cabinet Housing	36	WS405X	5 Drawer Work Station Maple Top	24
4810	10-Drawer Versa-Bench	22	63605-6	30 x 30 x 60 13-Drawer Modular Cabinet	35	WS410X	10 Drawer Work Station Maple Top	24
50002	2-Panel Toolboard Set	26	63609-12	30 x 30 x 60 Modular Cabinets	35	WC28	Wall Storage Cabinet	24
50004	4-Panel Toolboard Set	26	63616-21	30 x 30 x 60 Modular Cabinets	35	WT48	Maple Work Surface	23
50051	21" x 16" Toolboard Storage Bag	28	63680	Modular Cabinet Doors	43	WT60	Maple Work Surface	23
50052	16" x 24" Toolboard Storage Bag	28	63902-08	Latching Drawers for Mobile Modular Cabinet	41	WT6030	Maple Work Surface	39
50053	Push/Pull Handle	27	64103-10	FX Drawers For 44x30 Modular Cabinets	38	WT7230	Maple Work Surface	39
			64112	FX Drawers For 44x30 Modular Cabinets	38			
			64114	FX Drawers For 44x30 Modular Cabinets	38			

Kennedy Catalog
Revision 05-12
KMC002



1260 INDUSTRIAL DRIVE

Since 1911

Kennedy®

USA MADE CHESTS AND CABINETS

VAN WERT, OH 45891

www.kennedymfg.com

Toll Free: 1.800.413.8665 • Local: 419.238.2442 • Fax: 419.238.5644