



Bucket Top Mountain Train Set









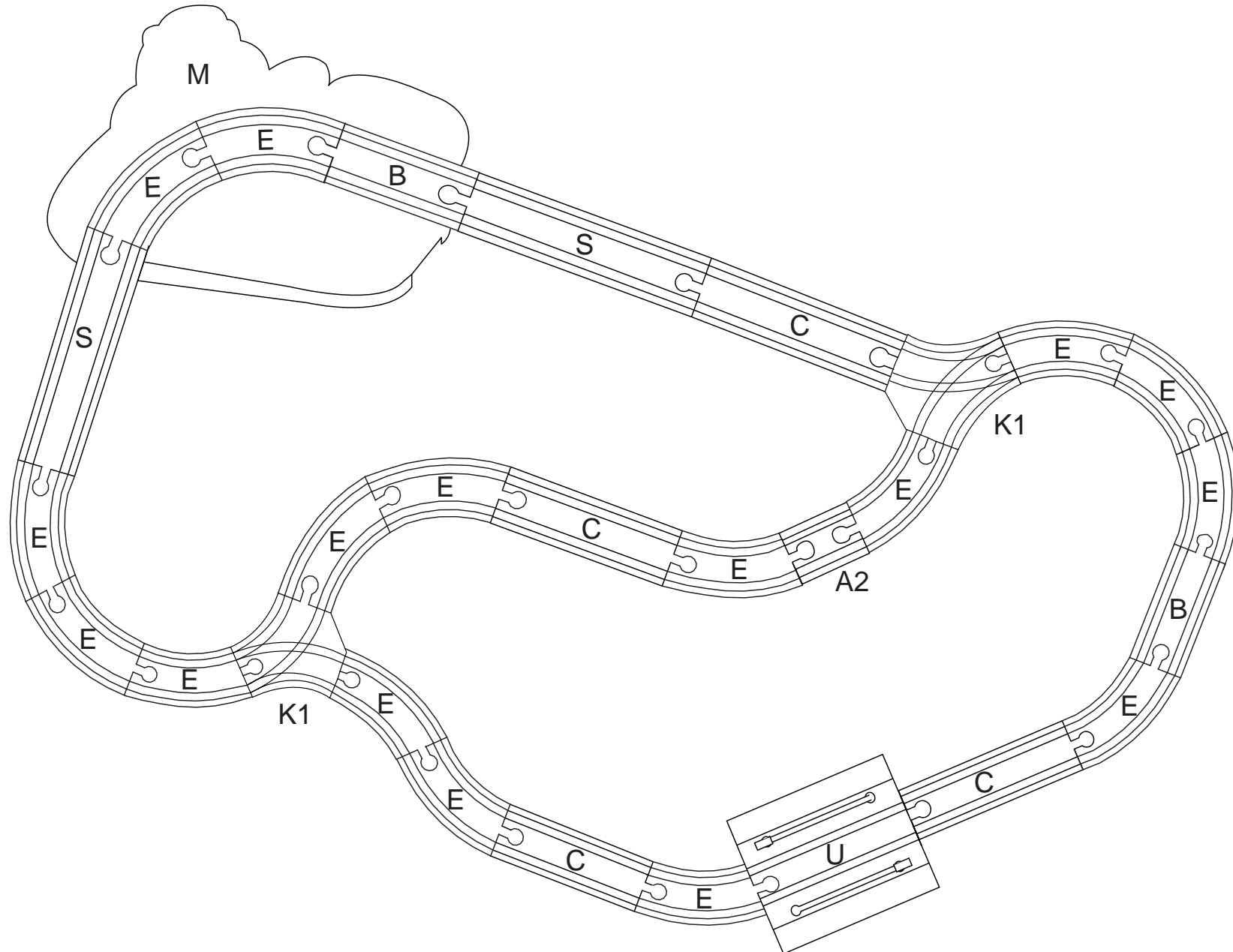

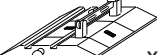











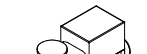

Assembly Instructions

© 2010 KidKraft, LP

Please retain this information for future reference

Item #17826



A2  x 1	U  x 1	B  x 2	C  x 4	S  x 2	E  x 16
K1  x 2	140 A,D,F  x 1 x 1 x 1 = 3	2PCTREE  x 3	SL  x 2	101 A,D  x 1 x 1 = 2	VH  x 1
TCP  x 1	PC  x 1	FE  x 1	TE  x 1	CGT  x 1	801  x 1
PS  = 3	FS  = 3	529  x 1	RW1  x 1	RW2  x 1	RW3  x 1
AP  x 1	M  x 1				

Airport Assembly Instructions (AP)

HARDWARE:

A. Screw x 4 pcs
5/8 in, 16 mm

The following tool (not included) is required for assembly:



Phillips® Screwdriver

PARTS LIST:

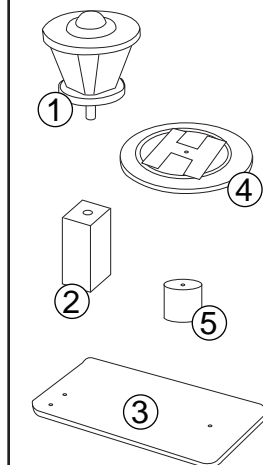

Step 1

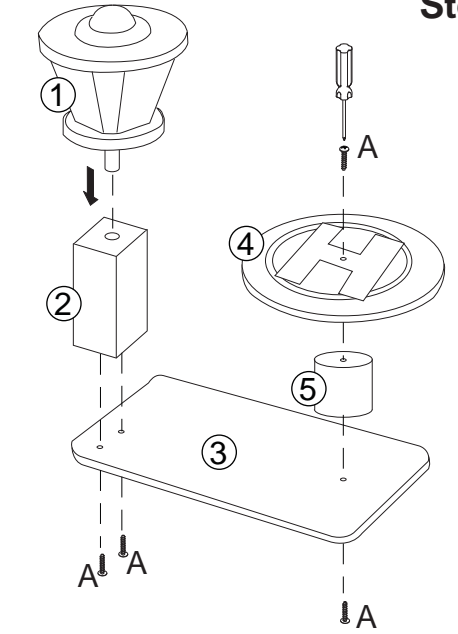

⚠ WARNING:
ADULT ASSEMBLY REQUIRED.
Product includes small parts with potentially hazardous sharp points and sharp edges in the unassembled state. Keep unassembled parts away from children.

USE AND MAINTENANCE:
-Use on level surfaces only
-Please check assembly at regular intervals, and frequently tighten hardware if necessary. If maintenance is not carried out, the product could cease to function properly.

⚠ WARNING:
CHOKING HAZARD. Small parts and sharp points, not suitable for children under 3 years.

Before calling customer service, please locate the batch code number (example: 105906/65006/04) found on the bottom or back of your product.

Customer Service
1-800-933-0771
www.kidkraft.com



WARNING! This product contains small magnets that can be hazardous if swallowed. Seek immediate medical attention if magnet(s) are swallowed or inhaled.

Imported by/ Manufactured by:
KidKraft Netherlands BV
Olympisch Stadion 9
1076DE Amsterdam
The Netherlands

IMPORTANT INFORMATION - PLEASE READ FIRST

THIS TOY IS INTENDED FOR THE ENJOYMENT AND DEVELOPMENT OF CHILDREN BETWEEN THE AGES OF 3 AND UP. IT HAS BEEN SPECIFICALLY DESIGNED AND TESTED FOR USE BY CHILDREN OF THAT AGE RANGE IN A CONSTRUCTIVE SETTING. BECAUSE OF THE DANGER OF SMALL PARTS BECOMING A CHOKING HAZARD FOR TODDLERS, DO NOT BUY YOUR 2-YEAR-OLD A TOY MEANT FOR CHILDREN AGES 3 AND ABOVE. PARENTAL SUPERVISION AND INSPECTION IS ALWAYS REQUIRED TO PREVENT INJURY AND MISUSE OR DEGRADATION OF THE TOY, REGARDLESS OF THE AGE OF THE CHILD. USE OF THE TOY BY PERSONS OTHER THAN CHILDREN OF THE INTENDED AGE MAY RESULT IN INJURY TO THE USER OR BYSTANDER OR BREAKAGE OF THE TOY. CONTINUED PARENTAL SUPERVISION AND INSPECTION IS VITAL TO THE SAFE USE OF THE TOY AS SMALL PARTS MAY BREAK OFF OR COME LOOSE OVER TIME AND DURING USE, AND SHARP EDGES MAY RESULT FROM MISUSE, HEAVY USE, AGE OF THE TOY, OR THE ENVIRONMENT, INCLUDING RECURRING HEAT, COLD AND WATER. TO SAFEGUARD THE CHILD AND PROLONG THE SAFE LIFE OF THE TOY, FOLLOW THE ENCLOSED ASSEMBLY AND MAINTENANCE INSTRUCTIONS CAREFULLY AND HONOR ALL WARNINGS. INSPECT FOR LOOSE AND BROKEN PARTS FREQUENTLY. SHOULD YOU HAVE ANY QUESTIONS OR CONCERNS, PLEASE CONTACT US.

CLEANING INSTRUCTIONS

CLEAN THE SURFACE USING A SLIGHTLY DAMP CLOTH AND MILD DISH WASHING LIQUID IF NECESSARY. DO NOT USE ANY CLEANING PRODUCT CONTAINING ALCOHOL OR AMMONIA. THESE WILL DULL THE SHINY SURFACE OF THE PRODUCT. FURNITURE POLISH WILL ALSO WORK TO CLEAN AND DUST OFF THE SURFACE.

WE RECOMMEND THAT YOU TEST ALL CLEANING MATERIALS ON THE UNDERSIDE OF ANY SURFACE THAT WOULD NOT BE SEEN DURING NORMAL USE OF THE PRODUCT. IF YOU HAVE QUESTIONS REGARDING THE MAINTENANCE OF THIS PRODUCT PLEASE FEEL FREE TO CONTACT US.

SOLE AND LIMITED WARRANTY

THIS TOY IS WARRANTED SOLELY AGAINST MANUFACTURING DEFECTS FOR A PERIOD OF 90 DAYS THE DATE OF PURCHASE, WHICH RUNS ONLY TO THE ORIGINAL USER OF THE TOY. IN THE EVENT OF A MANUFACTURING DEFECT, PARTS WILL BE REPLACED OR THE ENTIRE PRODUCT WILL BE REPLACED OR THE PURCHASE PRICE WILL BE REFUNDED, AT THE ELECTION OF THE MANUFACTURER.

TO ACTIVATE AND PROTECT THIS WARRANTY, PRESERVE EVIDENCE OF ORIGINAL PURCHASE AND CAREFULLY INSPECT THE CONDITION OF THE TOY PRIOR TO AND AFTER ASSEMBLY, LOOKING FOR MISSING, DEGRADED, BROKEN OR HAZARDOUS PARTS, INCLUDING PARTS WHICH CAN BE SWALLOWED BY A CHILD, CAUSE A CHILD TO CHOKE, OR OTHERWISE CAUSE INJURY. SUCH PARTS MAY INCLUDE MAGNETS, WHEELS, HUBS, FASTENERS, AND CONNECTORS. SHOULD YOU OBSERVE ANY DEFECTS, DO NOT USE THE TOY AND IMMEDIATELY NOTIFY THE MANUFACTURER. FAILURE TO DO SO SHALL CONSTITUTE MISUSE. MISUSE, IMPROPER ASSEMBLY, FAILURE TO HONOR A WARNING, FAILURE TO SUPERVISE, INSPECT OR MAINTAIN THE TOY, OR DAMAGE TO THE TOY, WHETHER INTENTIONAL OR INADVERTENT, SHALL INVALIDATE THIS WARRANTY. THIS WARRANTY GIVES YOU SPECIFIC LEGAL RIGHTS, AND YOU MAY ALSO HAVE OTHER RIGHTS WHICH VARY FROM STATE TO STATE.