

OPERATION MANUAL

MODEL 60-552204

SUPPLIER CODE: FH-60-552204

VIROQUE MESH CHAIR WITH ADJUSTABLE BACK ANGLE



CUSTOMER SERVICE





For fastest service, please visit our website at
www.comfortproducts.net/support

Keep your sales receipt as documentation of your ownership.

CONTENTS



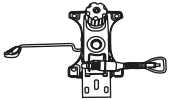
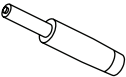

EXTRA SPARE HARDWARE INCLUDED FOR YOUR CONVENIENCE. ITEMS ARE NOT SHOWN TO SCALE.

PARTS LIST

PART	DESCRIPTION	STOCK#	QTY..
A	Back Cushion 	61-552204A	1
B	Seat Cushion 	61-552204B	1
C	Armrests (left) Armrest (right) 	61-ARM552204L 61-ARM552204R	1 1
D	Seat Plate 	61-PLATE5522	1
E	Gas Lift (seat post) 	61-POST5522	1
F	Star Base 	61-BASE552204	1
G	Caster 	61-CASTA	5

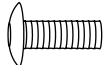
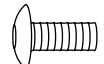
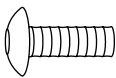
HARDWARE KIT

STOCK# 61-SCRWSET5522

PART	DESCRIPTION	QTY.
H	M6 x 30mm Screw 	6
I	M6 x 20mm Screw 	4
J	M6 x 35mm Screw 	3
K	6x18x1mm Washer 	4
L	8x22x1.5mm Washer 	3
M	M8 Washer 	3
N	M5 Allen Wrench 	1

REPLACEMENT PARTS

IF YOU ARE MISSING ANY OF THE PARTS ABOVE, OR IF YOU HAVE A DAMAGED PART, PLEASE VISIT WWW.COMFORTPRODUCTS.NET/SUPPORT AND REFERENCE THE MODEL NUMBER AND SUPPLIER CODE ON THE FRONT OF THIS MANUAL. SIMPLY COMPLETE THE INFORMATION, AND THE PART YOU NEED. THE PART WILL NORMALLY SHIP WITHIN 48 HOURS.

ASSEMBLY INSTRUCTION (60-552204)

DO NOT TIGHTEN SCREWS UNTIL COMPLETELY ASSEMBLED

STEP 1

Attach the left and right armrests (C) to bottom of seat cushion (B) using six screws (H) and allen wrench (N) as shown.

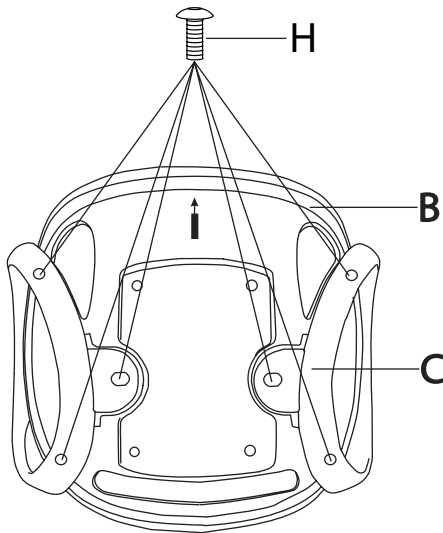

STEP 2

Attach seat plate (D) to bottom of seat cushion (B) using four screws (I) and washers (K) as shown.

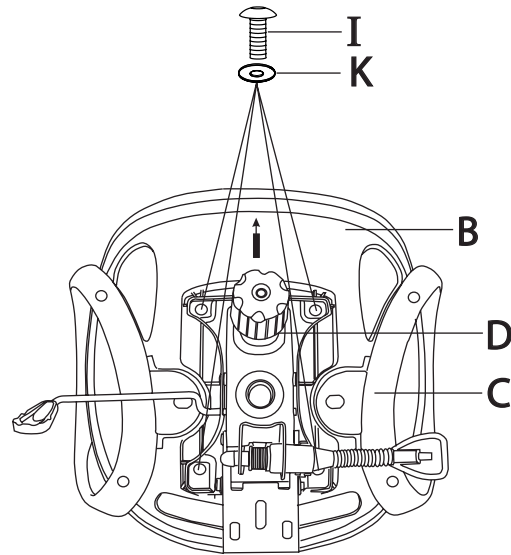

STEP 3

Attach the back cushion (A) to seat cushion (B) using three screws (J) and washers (M) and (L) as shown.

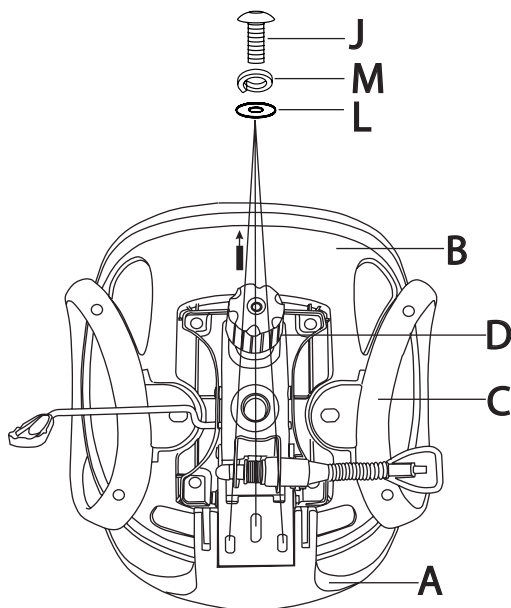

STEP 4

Insert five casters (G) into star base (F) as shown. Then insert gaslift (E) into star base (F) as shown.

Position the center hole in seat plate over the gaslift. Then carefully lower the chair onto the gaslift.

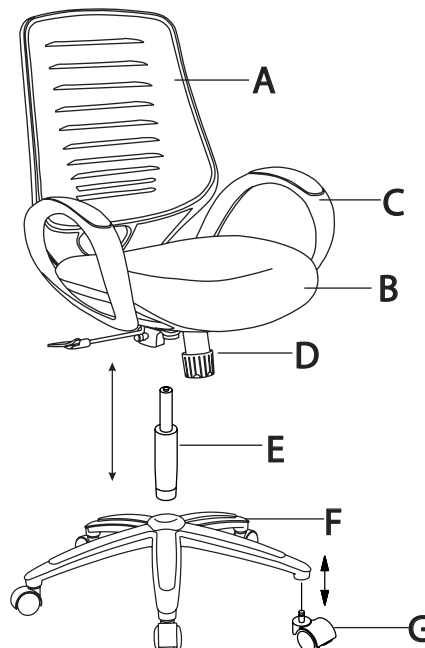

NOTE: To install casters, apply pressure to base of caster using your thumb as shown

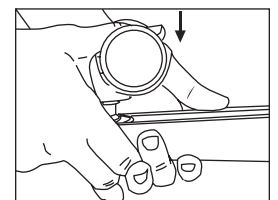

FUNCTION INSTRUCTION (60-552204)

TO ADJUST SEAT HEIGHT.....

While seated, lean forward, lifting your body weight from the seat. Reach underneath the right side of chair and locate the handle. Lift the handle up slowly with a clockwise twisting motion to allow the chair to rise to the desired height. To lower seat height, lift the handle slowly with a clockwise twisting motion while seated.

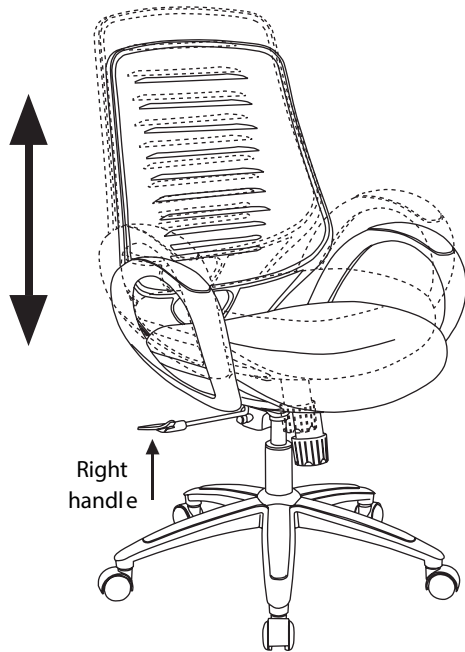

TO ADJUST BACK ANGLE.....

While seated, reach underneath the left side of chair and locate the handle. Carefully lift the handle upward to highest point. You are now able to recline in the chair. To lock the back cushion at your desired angle, simply recline to the desired angle, and lower the handle to its lowest position. The back angle is now set, but you will not be able to tilt until the handle is lifted to its highest position again.



TO ADJUST TILT TENSION.....

Reach under the front center of the chair seat and grasp the round black tension knob. To loosen the tilt mechanism, turn the knob clockwise. This lessens the effort required to recline the back cushion of the chair. To tighten the tension knob, rotate counter-clockwise. Rotate the knob until the desired resistance is reached.



360 DEGREE SWIVEL.....

360 degree seat swivel



FREQUENTLY ASKED QUESTIONS

- WHERE DO I FIND THE MODEL NUMBER AND SUPPLIER CODE FOR MY CHAIR?

The chair model number and supplier code is located on a sticker underneath the seat cushion, and on the front page of your instruction manual.

- HOW DO I ORDER REPLACEMENT PARTS? WHEN AM I GOING TO RECEIVE THEM?

For fastest service, please visit us at www.comfortproducts.net/support. Simply fill in the information, and the part you need. If your chair is covered under warranty, there is no charge for replacement parts. We normally ship replacement parts within 48 hours.

- HOW DO I ADJUST THE SEAT HEIGHT?

Refer to page 3. While seated, lean forward, lifting your body weight from the seat. Reach underneath the right side of chair and locate the handle. Lift the handle up slowly with a clockwise twisting motion to allow the chair to rise to the desired height. To lower seat height, lift the handle slowly with a clockwise twisting motion while seated.

- HOW DO I RECLINE (TILT), ADJUST THE BACK ANGLE, AND OPERATE THE TILT LOCKOUT?

While seated, reach underneath the left side of chair and locate the handle. Carefully lift the handle upward to highest point. You are now able to recline in the chair. To lock the back cushion at your desired angle, simply recline to the desired angle, and lower the handle to its lowest position. The back angle is now set, but you will not be able to tilt until the handle is lifted to its highest position again. If your chair tilts backwards, then you may have the seat plate on backwards.

- HOW SHOULD THE CHAIR BE CLEANED?

While we do not recommend a particular brand of cleaning product, you can use a damp cloth to wipe down your chair. Or you can use an over-the-counter cleaner made for the polyester mesh upholstery on your chair. If you would like to use a cleaning product, we suggest that you test the cleaner on the bottom side of the chair first to make sure the cleaner doesn't alter the material, before applying the product on the entire chair. Please note that any type of discoloration or alteration made to the chair from a cleaner will automatically void the warranty.

- THE CASTERS ARE DIFFICULT TO INSTALL. HOW DO I INSTALL THE CASTERS?

Refer to inset image on page 2, STEP 4. The metal stem needs to be fully inserted into the bottom of the star base in order for the caster to stay in. There are 2 options. One: lay the base on the carpeted ground, with the bottom of the base facing upward. Insert each caster into the hole by applying pressure with your thumb at the base of caster. They should pop in easily. Two: hold the 5-star base in an upright position (One leg is on a carpeted floor). Insert each caster into the hole. Apply pressure with one hand, while using the other to hold the base in place. You may need push the caster in with a little force, (twisting or using a soft mallet to tap in).

- MY CASTER BROKE. HOW DO I REMOVE THE METAL STEM FROM THE BASE?

You can use pliers to remove the metal pin. Please contact www.comfortproducts.net/support and request a 61-CASTA replacement caster.

- THE CHAIR SEEMS TO WOBBLE SIDE-TO-SIDE. HOW CAN I FIX IT?

Make sure all screws are properly tightened, especially the screws attaching the seat plate to the seat cushion. If this does not solve the problem please contact us at www.comfortproducts.net/support, or customerservice@comfortproducts.net.

- THE CHAIR SINKS OR THE GAS LIFT (SEAT POST) DOES NOT MAINTAIN ITS PRESSURE.

Refer to question above, "How do I adjust the seat height?" If the seat will not maintain its height, order a new gas lift at www.comfortproducts.net/support. Just fill out the information on the form. The part # for a new gas lift is 61-POST5522. To remove your gas lift from the seat plate (#61-PLATE5522), refer to page 6 for removing and reassembling the gas lift and links to video demonstrations.

- HOW DO I REMOVE/REPLACE THE SEAT PLATE AND/OR GAS LIFT?

Refer to page 6 for images and links to video demonstrations. To remove the seat plate from the gas lift: you will need to turn your chair over. Next, get a rubber mallet. You will want to hit around the area that the gas lift (Cylinder) goes inside the seat plate (The black metal plate attached to the seat that has a handle). After you hit the seat plate, give the gas lift a pull and see if it is coming loose. These two items are locked together by pressure; the more you hit the seat plate the more pressure will be released. Eventually the two items will separate. To remove the gas lift from the five star base: please turn the chair upside down. There are about one to two inches where the gas lift (Cylinder) goes through the 5 star base (The legs with wheels). Next, grab a rubber mallet. Then, if you look in the center of the gas lift, there is a little clip. You DO NOT want to hit the clip in the middle as it will release the pressure needed in order to raise or lower your chair. You will want to hit the outer edge or the rim of the gas lift. The more you hit the gas lift the more pressure will be released. After you give the gas lifts a few hits, it should come right out, or give it a pull and see if its loose. If it still won't budge, then visit www.comfortproducts.net/support or e-mail us at customerservice@comfortproducts.net to order a new seat plate and gas lift.

- HOW DO I REMOVE/REPLACE THE BASE FROM THE GAS LIFT?

Refer to page 6. You will need to use a rubber mallet and tap the post from the underside of the base. If you are still unable to disengage the base, order a new gas lift post and seat plate. If it still won't budge, visit us at www.comfortproducts.net/support and simply request a new base #61-BASE552204.

- THE ARMRESTS SEEM LOOSE. HOW CAN I FIX THEM?

Make sure all screws are properly tightened.

- THE PARTS DON'T SEEM TO ALIGN. WHAT SHOULD I DO?

Do not tighten the hardware completely into the component you are assembling. Tighten hardware a quarter of the way. When all components are aligned, and the product is sitting level, then you can tighten all the screws.

- THE SCREWS WON'T THREAD INTO THE HOLES. WHAT SHOULD I DO?

Be certain that you are aligned with the hole. Sometimes holes in soft upholstered areas are deep set, and you may not be making contact with the female inset for the screw. Also, check that there is no debris on the screw or in the inset for the screw. You can also try the spare screw.

- WHAT IS THE WARRANTY LENGTH?

The warranty for your specific chair or furniture item is based on the year your item was purchased. Please note that proof of purchase is required for validation of warranty. The current warranty for seating is: one year for cushions and parts (unless otherwise specified). You do not need to register your warranty.

- HOW IS THE WARRANTY VALIDATED?

Your warranty time period is validated by the purchase date on your original purchase receipt. (Please note that the warranty can not be validated without your original purchase receipt).

- WHAT IS THE WEIGHT LIMIT ON MY CHAIR?

Our chairs have been tested to meet BIFMA standards, and have a weight limit of up to 225 lbs, unless stated otherwise. Please refer to your warranty sheet or instruction manual for the weight limit on your chair.

SAFETY AND MAINTENANCE

- DO NOT stand on the chair. DO NOT use the chair as a stepladder.
- Use this product for seating one person at a time.
- DO NOT use this chair unless all bolts and screws are firmly secured.
- Avoid contact with sharp objects to prevent puncturing the fabric.
- Every 6 months, check all bolts and screws to ensure they are tight.
- To clean, spot clean only using a damp towel and mild cleaner. First test on a small, obscure area of fabric.
- Chair weight limit not to exceed 225 lbs.

LIMITED WARRANTY

PLEASE VISIT WWW.COMFORTPRODUCTS.NET FOR WARRANTY INFORMATION

Comfort Products warrants this product to be free from defects in material and workmanship for 1 year. This warranty is made by Comfort Products only to the original end-user customer acquiring the product directly from Comfort Products' authorized dealers as shown by the original sales receipt. The end-user customer remedy pursuant to this warranty is limited to repair or replacement of parts at Comfort Products' option within a reasonable amount of time. Comfort Products reserves the right to require damaged parts to be returned to Comfort Products upon request. Natural markings such as scars, brands, grain, variations, wrinkles, color variations, etc. will be considered normal characteristics, and not construed as defects. Comfort Products cannot warrant leather against scratching or scuffing, as all leather is subject to blemishes with use. Consent from Comfort Products must be obtained before any warranty work is performed. This warranty shall not apply to any products which must be replaced because of normal wear and tear, negligence, abuse, or "accident", shipping damage or product use and installation other than in accordance with written instructions or warnings. It will also not apply when a product has been modified or altered, repaired, refurbished by someone other than Comfort Products or because of natural variations over which Comfort Products has no control. When repairing or replacing a defective product, Comfort Products does not guarantee matching color, grain, texture or dye lots. This warranty does not cover the cost of transportation or labor. In no event shall Comfort Products be liable in either tort or contract for any loss or direct, special, incidental, consequential or exemplary damages. This Limited Warranty is NOT applicable to end-user customers who use Comfort Products for rental purposes. This warranty applies only to end-user customers in the United States. All warranties are limited to the original purchaser for normal use which is defined as a standard work week of 40 hours by a person weighing 225 lbs. or less (unless otherwise specified). For claims or questions concerning this warranty, please visit www.comfortproducts.net/support. Comfort Products customer service can be reached via e-mail at customerservice@comfortproducts.net.

MODEL: 60-552204

Comfort Products, Inc.
P.O. Box 999
Memphis, TN 38101
e-mail: customerservice@comfortproducts.net
www.comfortproducts.net



REMOVING A 5-STAR BASE FROM YOUR OFFICE CHAIR

(NOTE: YOUR PARTS MAY DIFFER SLIGHTLY FROM THOSE SHOWN BELOW)

TOOLS NEEDED: (1) Newspaper or cardboard for work area, (2) Silicone lubricant (such as WD40),(3) Rubber Mallet

INSTRUCTIONS:

- 1.) Spread newspaper or cardboard on your work surface.
- 2.) Turn your chair on its side.
- 3.) Spray lubricant around the center post where connected to your 5-star base.
- 4.) Remove casters (wheels) from base.
- 5.) Use the rubber mallet and bang on the center post, directly in the center of the 5-star base (Figure A).

These two parts are engaged by pressure alone. The more you hit it, the more pressure is released, and eventually the base will release from the post.

FIGURE A



REMOVING A GAS LIFT POST FROM YOUR OFFICE CHAIR

TOOLS NEEDED: (1) Newspaper or cardboard for work area, (2) Silicone lubricant (such as WD40),(3) Rubber Mallet

INSTRUCTIONS:

- 1.) Follow instructions for removing 5-star base.
- 2.) Spray gas lift where connected to seat plate.
- 3.) With rubber mallet, beat on seat plate around gas lift post to release pressure (Figure B).

The gas lift post is engaged to the seat plate by pressure alone. By banging on the seat plate, you should be able to reduce the pressure and remove the gas lift.

FIGURE B



REASSEMBLING YOUR OFFICE CHAIR WITH REPLACEMENT PARTS

Tools needed: Newspaper or cardboard for work area.

INSTRUCTIONS:

- 1.) Place casters into holes of 5-star base. Try the caster in another hole if not a strong fit.
- 2.) Position the base on the ground and place the gas lift post into the center hole of the base (Figure C).
- 3.) Place the assembled chair on top of the post so that the post fits into the hole on the seat plate. Sit in the chair to re-engage all parts (Figure D.)

FIGURE C



The colored plastic button should be at the top as shown.

VIDEO LINKS

You may visit these websites for a helpful video demonstration about how to change your gas lift:

<http://bit.ly/TvWwot>

<http://bit.ly/Qic7ox>

If you have difficulty removing the gas lift from the base, refer to this video link:

<http://bit.ly/SPGyyO>

FIGURE D

