

OPERATION MANUAL

MODEL 60-6212

RELAXZEN MIDBACK CHAIR WITH 3-MOTOR MASSAGE



CUSTOMER SERVICE

For fastest service, please visit our website at

www.comfortproducts.net/support







e-mail: customerservice@comfortproducts.net

Keep your sales receipt as documentation of your ownership.

CONTENTS

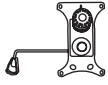
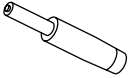
EXTRA SPARE HARDWARE INCLUDED FOR YOUR CONVENIENCE. ITEMS ARE NOT SHOWN TO SCALE.

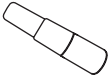
PARTS LIST

| PART | DESCRIPTION | STOCK# | QTY.. |
|------|---|----------------------------|--------|
| A | Back Cushion  | 61-6212AHZ | 1 |
| B | Seat Cushion  | 61-6212B | 1 |
| C | Armrest (left) Armrest (right)  | 61-ARM6212L 61-ARM6212R | 1 1 |
| D | Seat Plate  | 61-PLATEA | 1 |
| E | Gas Lift (seat post)  | 61-POSTA | 1 |
| F | Star Base  | 61-BASEE | 1 |
| G | Caster  | 61-CASTA | 5 |
| H | Gas Lift Cover  | 61-COVER | 1 |
| I | Power Adapter  | 61-ADAPT6212 | 1 |
| J | Controller  | 61-CNTRL6212HZ | 1 |

HARDWARE KIT

STOCK# 61-SCRWSETB

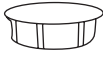
| PART | DESCRIPTION | QTY. |
|------|---|------|
| K | Screwcaps  | 8 |
| L | Washer  | 4 |
| M | M6 x 25mm Screw  | 12 |
| N | Allen Wrench  | 1 |

REPLACEMENT PARTS

IF YOU ARE MISSING ANY OF THE PARTS ABOVE, OR IF YOU HAVE A DAMAGED PART, PLEASE VISIT WWW.COMFORTPRODUCTS.NET/SUPPORT. SIMPLY COMPLETE THE INFORMATION, AND THE PART YOU NEED. THE PART WILL NORMALLY SHIP WITHIN 48 HOURS.

ASSEMBLY INSTRUCTION (60-6212)

DO NOT TIGHTEN SCREWS UNTIL COMPLETELY ASSEMBLED

STEP 1

Insert casters (G) into holes of star base (F). Insert gas lift (E) into center hole of star base (F). Place gas lift cover (H) over gas lift (E) as shown.

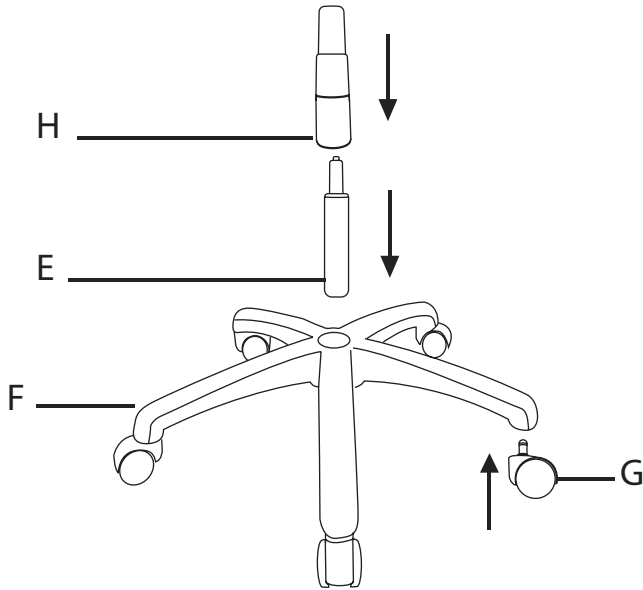

STEP 3

First, attach the left and right armrests (C) to the seat cushion (B), using the four screws (M) and the screwcaps (K) as shown. Then attach the left and right armrests (C) to the back cushion (A) using four screws (M) and the screwcaps (K) as shown.

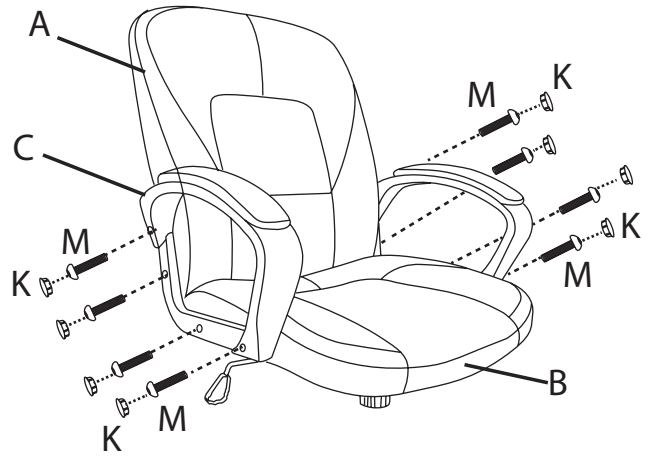

STEP 2

Align seat plate (D) over pre-drilled holes under seat cushion (B). (NOTE the position of seat plate handle to seat cushion FRONT). Attach seat plate (D) to seat cushion (B) using four screws (M) and four washers (L) as shown. Tighten securely with allen wrench (O).

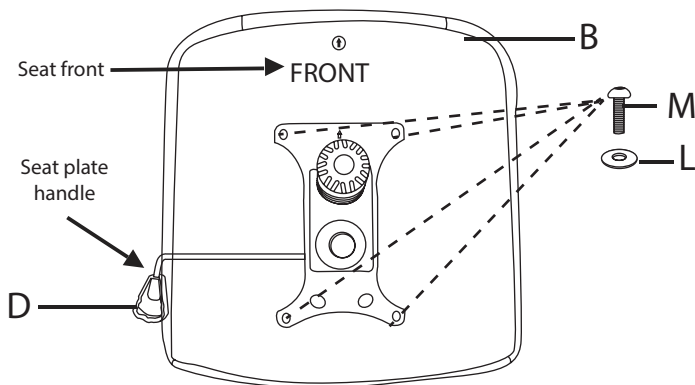

STEP 4

Turn assembled chair frame upright. Position the center hole in seat plate (D) over the gas lift (E). Then carefully lower the chair onto the gas lift.

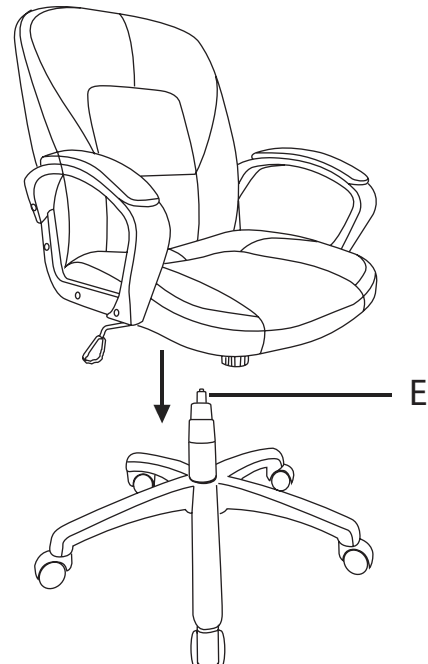

FUNCTION INSTRUCTION (60-6212)

TO ADJUST SEAT HEIGHT.....

While seated, lean forward, lifting your body weight from the seat. Reach underneath the right side of chair and locate the handle. Lift the handle up slowly to allow the chair to rise to the desired height. To lower seat height, lift the handle slowly while seated.

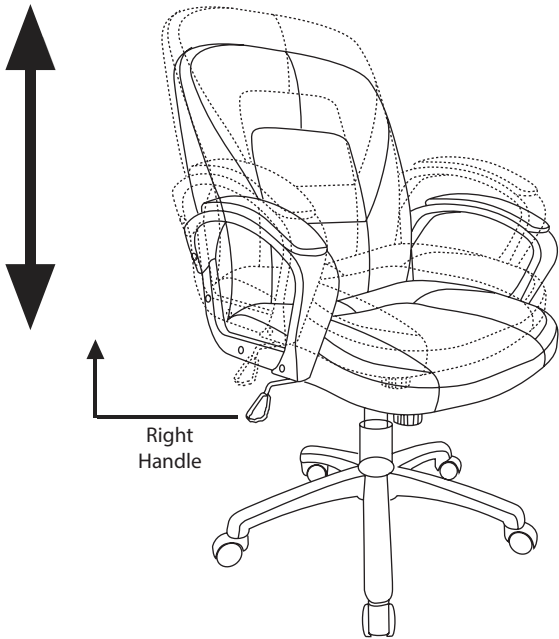

TO OPERATE TILT LOCKOUT.....

While seated, reach underneath the right side of chair and locate the handle. Slide the handle all the way out towards the right (away from the seat). When the handle is in this position, leaning back will cause the chair to tilt backwards. To lock the chair in the upright (vertical) position, sit in the chair, and push the handle in to the left (towards center of seat).

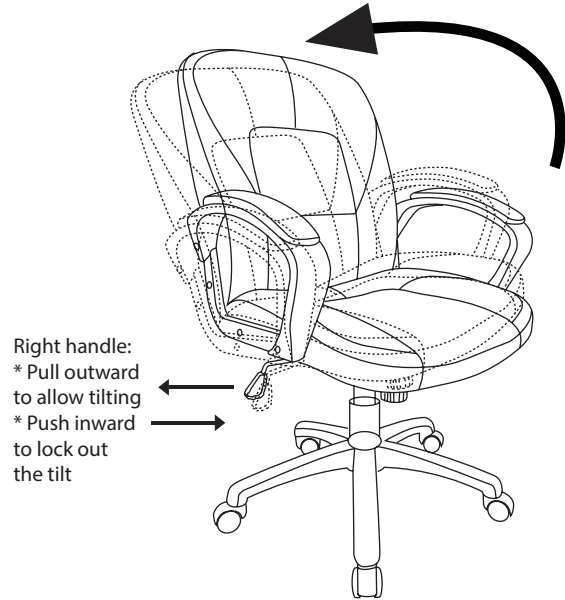

TO ADJUST TILT TENSION.....

Reach under the front center of the chair seat and grasp the round black tension knob. To loosen the tilt mechanism, turn the knob clockwise. This lessens the effort required to recline the back cushion of the chair. To tighten the tension knob, rotate counter-clockwise. Rotate the knob until the desired resistance is reached.

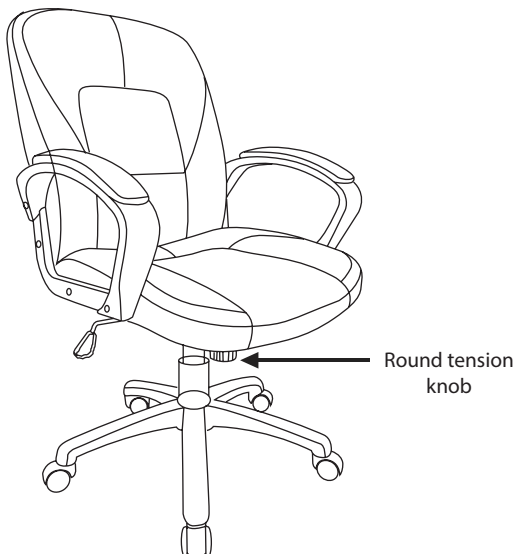

360 DEGREE SWIVEL

360 degree seat swivel



FUNCTION INSTRUCTION (60-6212)

TO CONNECT CONTROLLER.....

Your new office chair features 3 vibration massage motors to soothe your upper and lower back.

Connect the controller cord to the back cushion. Then connect the included power adapter to the chair, and plug into a standard power outlet.

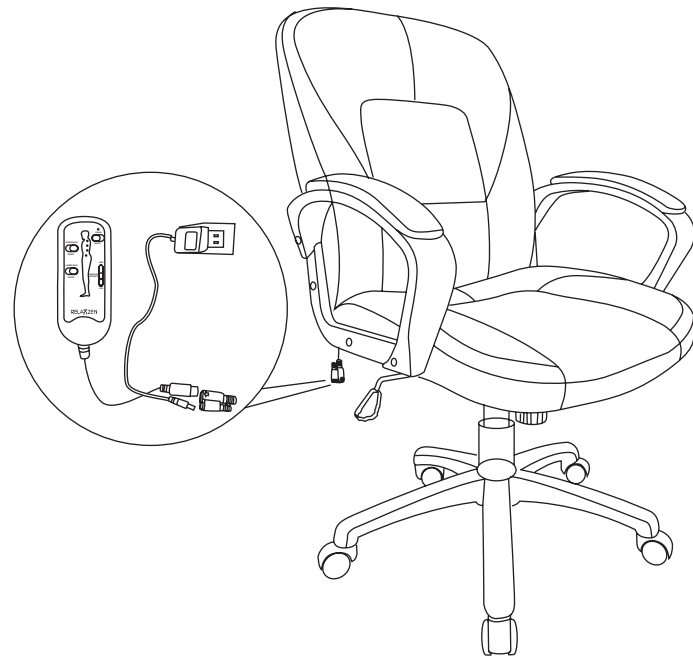

SAFETY AND MAINTENANCE.....

Do not use the massage motors for more than 30 minutes at a time. Always unplug the power adapter when massage is not in use.

If you have any health concerns about using the massage feature, consult your physician.

Do not use the massage motors when wet.

To clean the upholstery, unplug the adapter, and spot clean with leather or vinyl cleaner.

Use the chair to seat only one person at a time.

If the massage does not work, make sure all connections are correct. You should also try a different power outlet. If the massage still does not work, visit our website at www.comfortproducts.net/support and request a new controller (# 61-CNTRL6212HZ) and power adapter (# 61-ADAPT6212).

TO USE MASSAGE CONTROL.....

You can select either "upper back", "lower back" massage, or both. To adjust the massage intensity, simply use the slider on the controller to select your desired level.

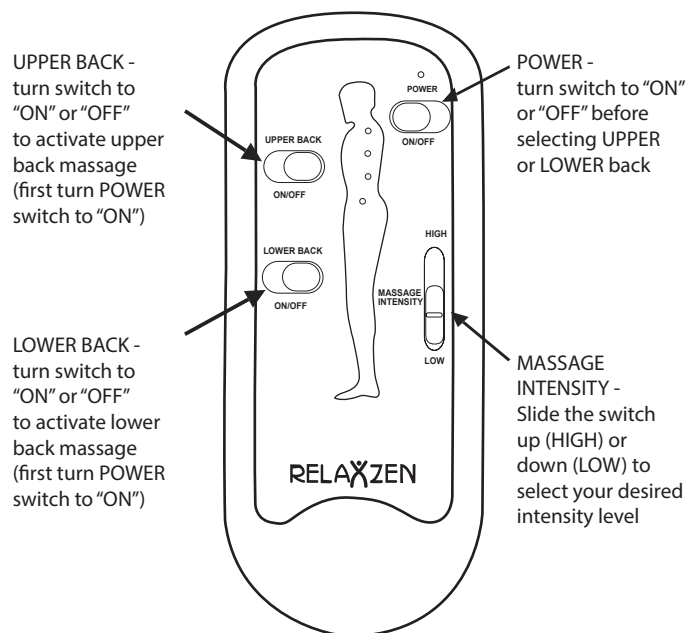

FREQUENTLY ASKED QUESTIONS

- HOW DO I ADJUST THE SEAT HEIGHT?

While seated, lean forward, lifting your body weight from the seat. Reach underneath the right side of chair and locate the handle. Lift the handle up slowly to allow the chair to rise to the desired height. To lower seat height, lift the handle slowly while seated.

- HOW DO I ADJUST THE TILT TENSION?

Reach under the front center of the chair seat and grasp the round black tension knob. To loosen the tilt mechanism, turn the knob clockwise. This lessens the effort required to recline the back cushion of the chair. To tighten the tension knob, rotate counter-clockwise. Rotate the knob until the desired resistance is reached.

- HOW DO I OPERATE THE TILT LOCKOUT?

While seated, reach underneath the right side of chair and locate the handle. Slide the handle all the way out towards the right (away from the seat). When the handle is in this position, leaning back will cause the chair to tilt backwards. To lock the chair in the upright (vertical) position, sit in the chair, and push the handle in to the left (towards center of seat). If your chair tilts backwards, then you may have the seat plate on backwards.

- HOW DO I INSTALL THE CASTERS?

The metal stem needs to be fully inserted into the bottom of the star base in order for the caster to stay in. There are 2 options. One: lay the base on the carpeted ground, with the bottom of the base facing upward. Insert each caster into the hole by applying pressure. They should pop in easily. Two: hold the 5-star base in an upright position (One leg is on a carpeted floor). Insert each caster into the hole. Apply pressure with one hand, while using the other to hold the base in place. You may need push the caster in with a little force, (twisting or using a soft mallet to tap in).

- MY CASTER BROKE HOW DO I REMOVE THE METAL STEM FROM THE BASE?

You can use a pair of pliers to remove the metal pin.

- HOW SHOULD THE CHAIR BE CLEANED?

Unplug the power adapter before cleaning the upholstery. While we do not recommend a particular cleaning product, you can use a damp cloth to wipe down your chair. Furniture stores should be able to recommend a product that is safe for the particular material on your chair. If you would like to use a cleaning product, we suggest that you test the product on the bottom side of the seat cushion first to make sure the product doesn't alter the material, before applying the product on the entire chair. Please note that any type of discoloration or alteration made to the chair from a cleaner will automatically void the warranty.

- WHAT MAINTENANCE IS RECOMMENDED FOR THE CHAIR?

We recommend tightening all screws every 6 months.

- WHERE DO I FIND THE MODEL NUMBER FOR MY CHAIR?

The chair model number is located on a sticker underneath the seat cushion, and on the front page of your instruction manual.

- HOW DO I ORDER REPLACEMENT PARTS? WHEN AM I GOING TO RECEIVE THEM?

For fastest service, please visit us at www.comfortproducts.net/support. Simply fill in the information, and the part you need. If your chair is covered under warranty, there is no charge for replacement parts. We normally ship replacement parts within 48 hours.

- SHOULD THE CLIP AT THE BOTTOM OF THE GAS LIFT BE REMOVED?

No, the clip needs to remain on the gas lift. Removing this clip will inhibit the gas lifts functions and void the warranty of the gas lift.

- THE CHAIR SINKS OR THE GAS LIFT (SEAT POST) DOES NOT MAINTAIN ITS PRESSURE.

Refer to first question above, "How do I adjust the seat height?" If the seat still sinks, order a new gas lift at www.comfortproducts.net/support. Just fill out the information on the form. The part # for a new gas lift is 61-POSTA. To remove your gas lift from the seat plate, refer to the instructions below, "How do I remove/replace the seat plate and/or gas lift?" If you are unable to remove the defective gas lift from the seat plate, simply request part # 61-PLATEA along with the gas lift.

- HOW DO I REMOVE/REPLACE THE SEAT PLATE AND/OR GAS LIFT?

To remove the seat plate from the gas lift: you will need to turn your chair over. Next, get a hammer. You will want to hit around the area that the gas lift (Cylinder) goes inside the seat plate (The black metal plate attached to the seat that has a handle and a knob). After you hit the seat plate, give the gas lift a pull and see if it is coming loose. These two items are locked together by pressure; the more you hit the seat plate the more pressure will be released. Eventually the two items will separate. To remove the gas lift from the five star base: please turn the chair upside down. There are about one to two inches where the gas lift (Cylinder) goes through the 5 star base (The legs with wheels). Next, grab a hammer. Then, if you look in the center of the gas lift, there is a little clip. You DO NOT want to hit the clip in the middle as it will release the pressure needed in order to raise or lower your chair. You will want to hit the outer edge or the rim of the gas lift. The more you hit the gas lift the more pressure will be released. After you give the gas lifts a few hits, it should come right out, or give it a pull and see if its loose. If it still won't budge, then visit www.comfortproducts.net/support to order a new seat plate and gas lift.

- HOW DO I REMOVE/REPLACE THE BASE FROM THE GAS LIFT?

You will need to use a rubber mallet and tap the post from the underside of the base. If you are still unable to disengage the base, order a new gas lift post and seat plate. If it still won't budge, visit us at www.comfortproducts.net/support and simply request a new base #61-BASEE.

- THE CHAIR SEEMS TO WOBBLE SIDE-TO-SIDE. HOW CAN I FIX IT?

Make sure all screws are properly tightened, especially the screws attaching the seat plate to the seat cushion.

- THE ARMRESTS SEEM LOOSE. HOW CAN I FIX THEM?

Make sure all screws are properly tightened.

- THE PARTS DON'T SEEM TO ALIGN. WHAT SHOULD I DO?

Do not tighten the hardware completely into the component you are assembling. Tighten hardware a quarter of the way. When all components are aligned, and the product is sitting level, then you can tighten all the screws.

- THE SCREWS WON'T THREAD INTO THE HOLES. WHAT SHOULD I DO?

Be certain that you are aligned with the hole. Sometimes holes in soft upholstered areas are deep set, and you may not be making contact with the female inset for the screw. Also, check that there is no debris on the screw or in the inset for the screw. You can also try the spare screw.

- WHAT IS THE WARRANTY LENGTH?

The warranty for your specific chair or furniture item is based on the year your item was purchased. Please note that proof of purchase is required for validation of warranty. The current warranty for seating is: one year for cushions and parts (unless otherwise specified). You do not need to register your warranty.

- HOW IS THE WARRANTY VALIDATED?

Your warranty time period is validated by the purchase date on your original purchase receipt. (Please note that the warranty can not be validated without your original purchase receipt).

- WHAT IS THE WEIGHT LIMIT ON MY CHAIR?

Our chairs have been tested to meet BIFMA standards, and have a weight limit of up to 225 lbs, unless stated otherwise. Please refer to your warranty sheet or instruction manual for the weight limit on your chair.

- THE MESSAGE DOES NOT WORK. WHAT SHOULD I DO?

If the massage does not work, make sure all connections are correct. You should also try a different power outlet. If the massage still does not work, visit our website at www.comfortproducts.net/support and request a new controller (# 61-CNTRL6212HZ) and power adapter (# 61-ADAPT6212). Do not use the massage motors for more than 30 minutes at a time. Always unplug the power adapter when massage is not in use, or when spot-cleaning the upholstery. If you have any health concerns about using the massage feature, consult your physician. Do not use the massage when wet.

SAFETY AND MAINTENANCE

- DO NOT stand on the chair. DO NOT use the chair as a stepladder.
- Use this product for seating one person at a time.
- DO NOT use this chair unless all bolts and screws are firmly secured.
- Avoid contact with sharp objects to prevent puncturing the fabric.
- Every 6 months, check all bolts and screws to ensure they are tight.
- To clean, unplug adapter and spot clean only using a damp towel and mild cleaner. First test on a small, obscure area of fabric.
- Do not use massage motors for more than 30 minutes at a time. Do not use when wet.
- Chair weight limit not to exceed 225 lbs.

LIMITED WARRANTY

Comfort Products warrants this product to be free from defects in material and workmanship for 1 year. This warranty is made by Comfort Products only to the original end-user customer acquiring the product directly from Comfort Products' authorized dealers as shown by the original sales receipt. The end-user customer remedy pursuant to this warranty is limited to repair or replacement of parts at Comfort Products' option within a reasonable amount of time. Comfort Products reserves the right to require damaged parts to be returned to Comfort Products upon request. Natural markings such as scars, brands, grain, variations, wrinkles, color variations, etc. will be considered normal characteristics, and not construed as defects. Comfort Products cannot warrant leather against scratching or scuffing, as all leather is subject to blemishes with use. Consent from Comfort Products must be obtained before any warranty work is performed. This warranty shall not apply to any products which must be replaced because of normal wear and tear, negligence, abuse, or "accident", shipping damage or product use and installation other than in accordance with written instructions or warnings. It will also not apply when a product has been modified or altered, repaired, refurbished by someone other than Comfort Products or because of natural variations over which Comfort Products has no control. When repairing or replacing a defective product, Comfort Products does not guarantee matching color, grain, texture or dye lots. This warranty does not cover the cost of transportation or labor. In no event shall Comfort Products be liable in either tort or contract for any loss or direct, special, incidental, consequential or exemplary damages. This Limited Warranty is NOT applicable to end-user customers who use Comfort Products for rental purposes. This warranty applies only to end-user customers in the United States. All warranties are limited to the original purchaser for normal use which is defined as a standard work week of 40 hours by a person weighing 225 lbs. or less (unless otherwise specified). For claims or questions concerning this warranty, please visit www.comfortproducts.net/support. Comfort Products customer service can be reached via e-mail at customerservice@comfortproducts.net.

MODEL: 60-6212

Comfort Products, Inc.
P.O. Box 999
Memphis, TN 38101
e-mail: customerservice@comfortproducts.net
www.comfortproducts.net

