

## AF640

### Premium Pull-Out Kitchen Sink Faucet

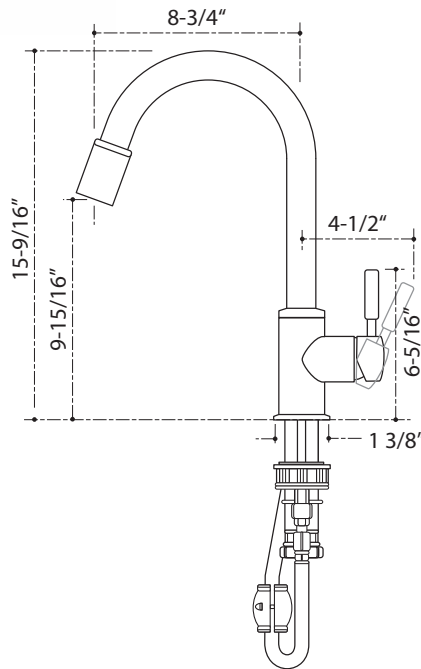

#### Model: AF640-SN

#### Dimensions

- Height: 15-9/16"
- Spout Reach: 8-3/4" center to center

#### Color/Finish

- Satin Nickel: AF640-SN

#### Features

- High quality solid brass construction
- Durable ceramic disc cartridge
- Triple Satin Nickel plating
- One-handle lever design for ease of use
- Engineered for long service
- Single opening
- Pull-down spout sprayer
- Limited lifetime warranty
- 2.2 gallons per minute maximum flow rate

#### Codes/Standards Applicable

-  ASME A112.18.1-2005/CSA B125.1-05
- Meets requirements for AB1953 - January 1, 2010

#### Product Specification

The contemporary pull-out kitchen sink faucet shall be of metal construction. This product shall have a maximum flow rate of 2.2 gallons per minute. This product shall have a one-piece, self-contained ceramic disc valve allowing volume and temperature control. This product has temperature memory, allowing the faucet to be turned on and off at any temperature setting. Product shall feature a sprayhead with spray, laminar flow, and pause settings. Product features a nylon hose and ball joint for easy operation and ADA compliant lever handle.

Kitchen faucet shall be Artisan Model AF \_\_\_\_\_ Finish \_\_\_\_\_