

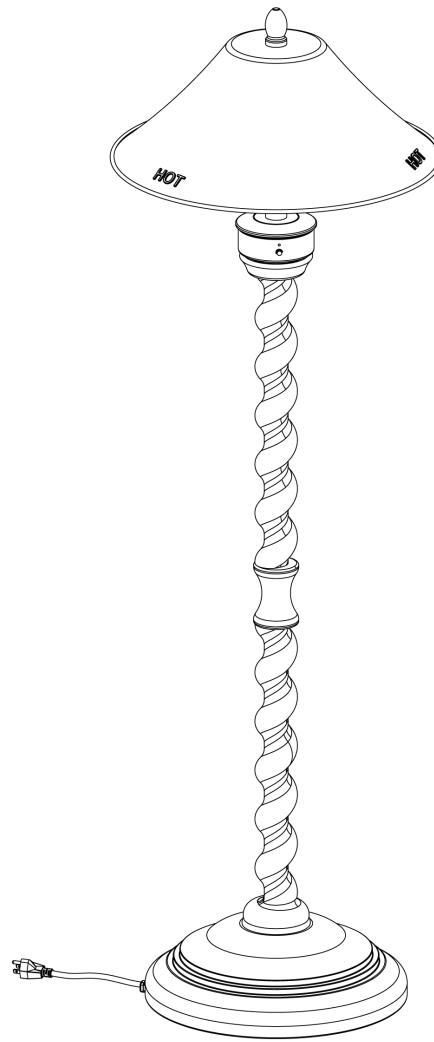

Outdoor Electric Patio Heater

Model No. EWUR810SP



 **WARNING**
FOR YOUR SAFETY:
For Outdoor Use Only
 (outside any enclosure)

 **WARNING**
FOR YOUR SAFETY:

1. Improper installation, adjustment, alteration, service or maintenance can cause injury or property damage.
2. Read the installation, operation, and maintenance instructions thoroughly before installing or servicing this equipment.
3. Failure to follow these instructions could result in fire or explosion, which could cause property damage, personal injury or death.
4. This instruction manual contains important information necessary for the proper assembly and safe use of the appliance.
5. Read and follow all warnings and instructions before assembling and using the appliance.
6. Follow all warnings and instructions when using the appliance.
7. Keep this manual for future reference.

 **WARNING**
FOR YOUR SAFETY:
 Do not store or use gasoline or other flammable liquids or vapors in the vicinity of this or any other appliance.

 **DANGER**
 Never operate this appliance unattended.

Danger
 Do NOT use electric grill for indoor cooking or heating. NOT to be used in or on boats or recreational vehicles.

Table of Contents

Important Safeguards	Page 2
Exploded View & Hardware	3
Assembly Instructions	4
Operating Instructions	5
Grounding Instructions	5
Before Turning "ON"	5
Turning "ON"	5
While Heater is "ON"	5
Turning "OFF"	5
Cleaning and Care	5
Cleaning Surfaces	5
Maintenance	5
Replacing the Fuse	5
Storage	5
Between Uses and During Periods of Extended Inactivity or When Transporting	5
Product Registration	6
Limited Warranty	6
Specifications	6
Troubleshooting	6

Save these instructions for future reference. If you are assembling this unit for someone else, give this manual to him or her to read and save for future reference.

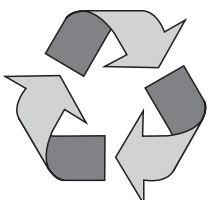

Made from 75% Bagasse

(Environmentally Friendly Sugar Cane Pulp By-product)



Manufactured in China for: Blue Rhino Global Sourcing, Inc.
 Winston-Salem, NC USA • 1.800.762.1142, www.bluerhino.com

© Blue Rhino Global Sourcing, Inc. All Rights Reserved
 Endless Summer® is a Registered Trademark of Blue Rhino Global Sourcing, Inc.. All Rights Reserved.

IMPORTANT SAFEGUARDS

When using electrical appliances, basic safety precautions should always be followed including the following:

1. Read all instructions before using this heater.
2. This heater is hot when in use. To avoid burns, do not let bare skin touch hot surfaces. If provided, use handles when moving this heater. Keep combustible materials, such as furniture, pillows, bedding, papers, clothes, and curtains at least a 3 feet (0.9 m) from the front of the heater and keep them away from the sides and rear.
3. Extreme caution is necessary when any heater is used by or near children or invalids and whenever the heater is left operating and unattended.
4. Always unplug heater when not in use.
5. Do not operate any heater with a damaged cord or plug or after the heater malfunctions, has been dropped or damaged in any manner. Return heater to authorized service facility for examination, electrical or mechanical adjustment, or repair.
6. This heater is not intended for use in bathrooms, laundry areas and similar indoor locations. Never locate heater where it may fall into a bathtub or other water container.
7. Do not run cord under carpeting. Do not cover cord with throw rugs, runners, or similar coverings. Arrange cord away from traffic area and where it will not be tripped over.
8. To disconnect heater, turn controls to off, then remove plug from outlet.
9. Connect to properly grounded outlets only.
10. Do not insert or allow foreign objects to enter any ventilation or exhaust opening as this may cause an electric shock or fire, or damage the heater.
11. To prevent a possible fire, do not block air intakes or exhaust in any manner. Do not use on soft surfaces, like a bed, where openings may become blocked.
12. A heater has hot and arcing or sparking parts inside. Do not use it in areas where gasoline, paint, or flammable liquids are used or stored.
13. Use this heater only as described in this manual. Any other use not recommended by the manufacturer may cause fire, electric shock, or injury to persons.
14. Avoid the use of an extension cord because the extension cord may overheat and cause a risk of fire. However, if you have to use an extension cord, the cord shall be No. 16 AWG minimum size and rated not less than 1500 watts.

15. SAVE THESE INSTRUCTIONS.

Safety First

DANGERS and *Cautions*

- ▲ This heater is for outdoor use only.
- ▲ This heater is NOT for commercial use.
- ▲ This is for use with electricity.
- ▲ For residential use only. This grill is NOT for commercial use.
- ▲ Longer detachable power-supply cords or extension cords are available and may be used if care is exercised in their use.
- ▲ This heater is safety certified for use in the United States and/or Canada only. Do not modify for use in any other location. Modification will result in a safety hazard.
- ▲ Apartment Dwellers: Check with management to learn the requirements and fire codes for using an electric heater in your apartment complex. If allowed, use outside on the ground floor with a ten (10) foot (3.05 m) clearance from any structure. Do not use on or under balconies.
- ▲ If a longer detachable power-supply cord or extension cord is used,
 - a. The cord shall be no. 16 AWG minimum size and rated not less than 1,500 watts.
 - b. The marked electrical rating of the cord set or extension cord should be at least as great as the electrical rating of the appliance, and
 - c. The cord should be arranged so that it will not drape over the countertop or tabletop where it can be pulled on by children or tripped over unintentionally.
- ▲ **ELECTRIC SHOCK CAN KILL OR RESULT IN SERIOUS INJURY. TO PREVENT ELECTRICAL SHOCK:**
 - a. Use only with GFI (Ground Fault Interrupter) protected circuit.
 - b. Do not use heater when raining.
 - c. To prevent heater from being splashed or falling into water, do not use heater within 10 feet of pool, pond, or other body of water.
 - d. Keep heater and cord dry and out of rain at all times.
 - e. Do not operate heater that has a damaged cord, plug, or metal probe. Call our customer service.
 - f. Never remove grounding plug, or use with an adapter to two prongs.
 - g. Keep electric plugs off ground, and dry.
- ▲ The use of alcohol, or prescription or non-prescription drugs may impair the consumer's ability to properly assemble or safely operate the appliance.
- ▲ Do not store or use gasoline or other flammable liquids or vapors within 25 feet (7.62 m) of this appliance.
- ▲ Do not use in an explosive atmosphere. Keep heater area clear and free from combustible materials, gasoline and other flammable vapors and liquids.
- ▲ **DO NOT** use this heater near any unprotected combustible constructions.
- ▲ Do not alter this heater in any manner.
- ▲ Do not use the heater unless it is **COMPLETELY** assembled and all parts are securely fastened and tightened.
- ▲ This heater should be thoroughly inspected on a regular basis.
- ▲ Use only Blue Rhino Global Sourcing, Inc. factory authorized parts. The use of any part that is not factory authorized can be dangerous. This will also void your warranty.
- ▲ Do not use this appliance without reading "Operating Instructions" in this manual.
- ▲ Do not touch metal parts of heater until it has completely cooled (about 45 min.) to avoid burns, unless you are wearing protective gear (pot holders, gloves, BBQ mittens, etc.).
- ▲ Do not touch hot surfaces.
- ▲ Do not use in or on boats or recreational vehicles.
- ▲ Do not leave a lit heater unattended, especially keep children and pets away from heater at all times.
- ▲ Do not attempt to move heater when in use. Allow the heater to cool before moving or storing.
- ▲ Always use your heater on a hard, non-combustible level surface.
- ▲ High temperature, keep electrical cords, drapery, and other furnishings at least 3 feet (0.9 m) from the front of the heater and away from the side and rear.
- ▲ After a period of storage and/or nonuse, inspect for any abrasion, wear, cuts to the electrical cord.
- ▲ The use of accessory attachments not recommended by the appliance manufacturer may cause injuries.
- ▲ Store products indoors when not in use – out of the reach of children.
- ▲ Servicing should be done only while the heater is disconnected from the power supply.
- ▲ To ensure continued protection against electrical shock, connect only to properly grounded outlets. Use with GFI protected electric outlet only.
- ▲ Do not immerse in water. Disconnect electric cord from outlet before cleaning, servicing and/or removing heating element.
- ▲ Do not partially or fully cover or obstruct this heater.
- ▲ Please use protective gloves when assembling this product.
- ▲ Do not force parts together as this can result in personal injury or damage to the product.
- ▲ Use this heater only as described in this manual. Any other use not recommended by the manufacturer may cause fire, electrical shock, or injury to persons.
- ▲ To reduce risk of shock, keep cord connection dry.
- ▲ Product must be fully assembled before operating the heater.
- ▲ Do not clean this product with a water spray or the like.
- ▲ Deaths, serious injury or damage to property may occur if the above is not followed exactly.

Contact 1.800.762.1142 for assistance. Do not return to place of purchase.

Parts List

1	Finial*	56-01-561
2	Dome Pole*	56-01-562
3	Dome*	56-01-563
4	Dome Brace*	56-01-564
5	Insulator*	56-01-496
6	Upper Pole*	56-01-565
7	Heat Reflector*	56-01-498
8	Heating Element Clip (4)*	56-01-499
9	Heating Element*	56-01-500
10	Wire Guard*	56-01-501
11	Bottom Guard Plate*	56-01-502
12	Post*	56-01-566
13	Fuse Cap*	56-01-504
14	Fuse (250V, 15A)*	56-01-505
15	Lower Body Assembly	56-01-567
16	Upper Body Post*	
17	Middle Body Post*	
18	Upper Body Post*	
19	Base*	
20	Power Cord*	
21	Cord Clamp	56-01-583

* Pre-assembled

Exploded View

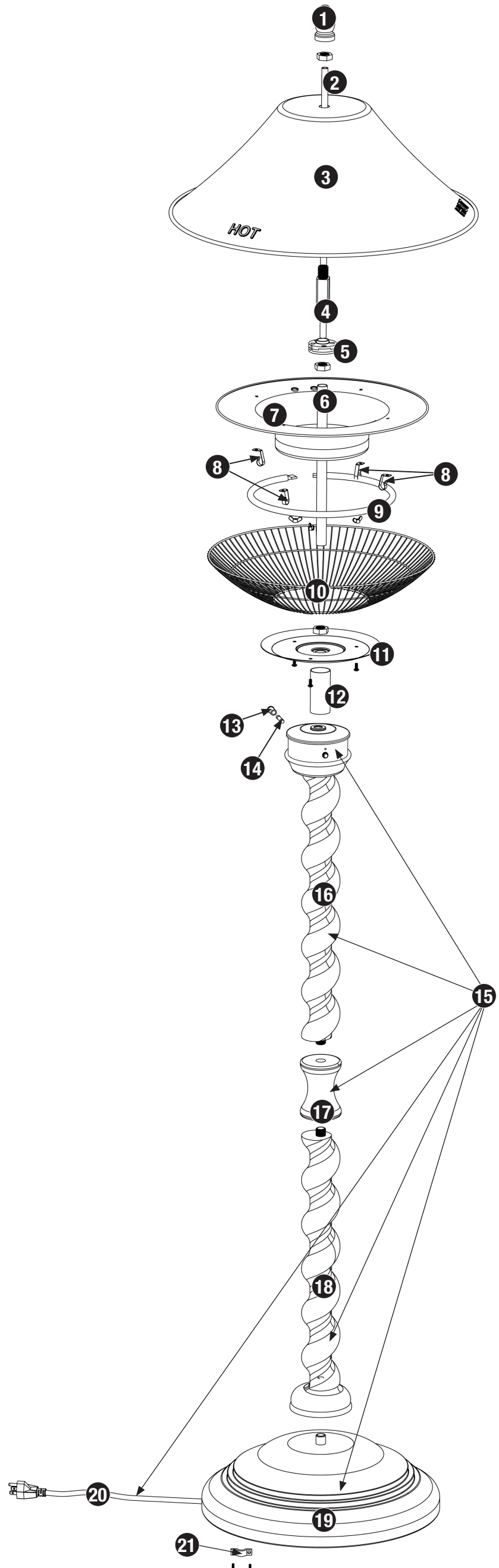

Hardware

A	Screw	M3 x 12 Zinc Plated Phillips	2 pcs
---	-------	------------------------------	-------

Tools Required for Assembly (Not Included)

Phillips Screwdriver, No. 2

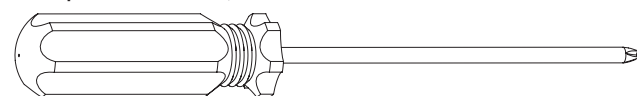

Assembly Instructions

1 DO NOT RETURN PRODUCT TO STORE.

For assistance call **1.800.762.1142** toll free. Please have your owner's manual and serial number available for reference.

For Easiest Assembly:

- To avoid losing any small components or hardware, assemble your product on a hard level surface that does not have cracks or openings.
- Clear an area large enough to layout all components and hardware.
- When applicable, tighten all hardware connections by hand first. Once the step is completed, go back and fully tighten all hardware.
- Follow all steps in order to properly assemble your product.

Note: Two (2) adults may be required for assembly.

2 Attach Body Posts and Head Assembly

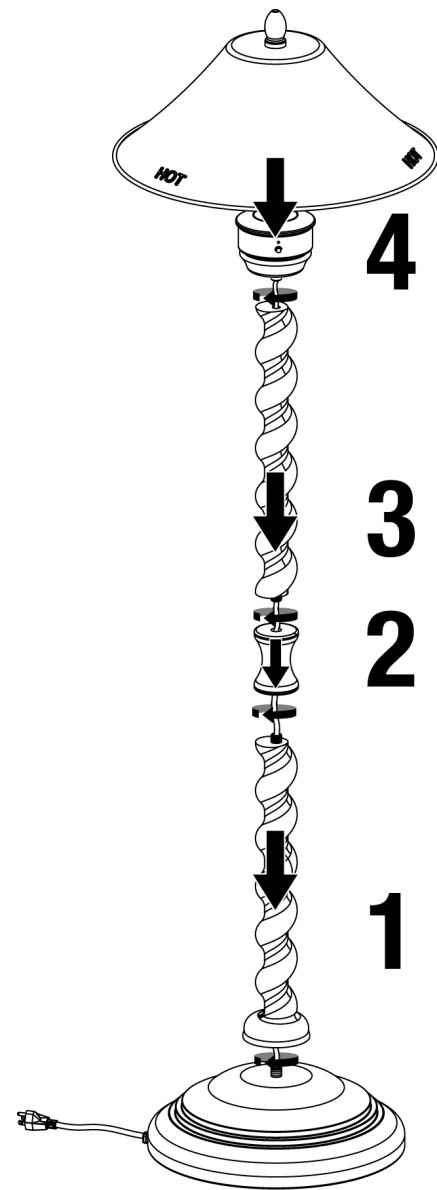

3 Pull Power Cord Tight and Attach Cord Clamp

Note: DO NOT force the power cord tight. Tuck any access cord in the base, above the metal bar.

CAUTION: DO NOT allow allow heater to rest on the cord, or the cord to drag on the ground. This will damage the cord.

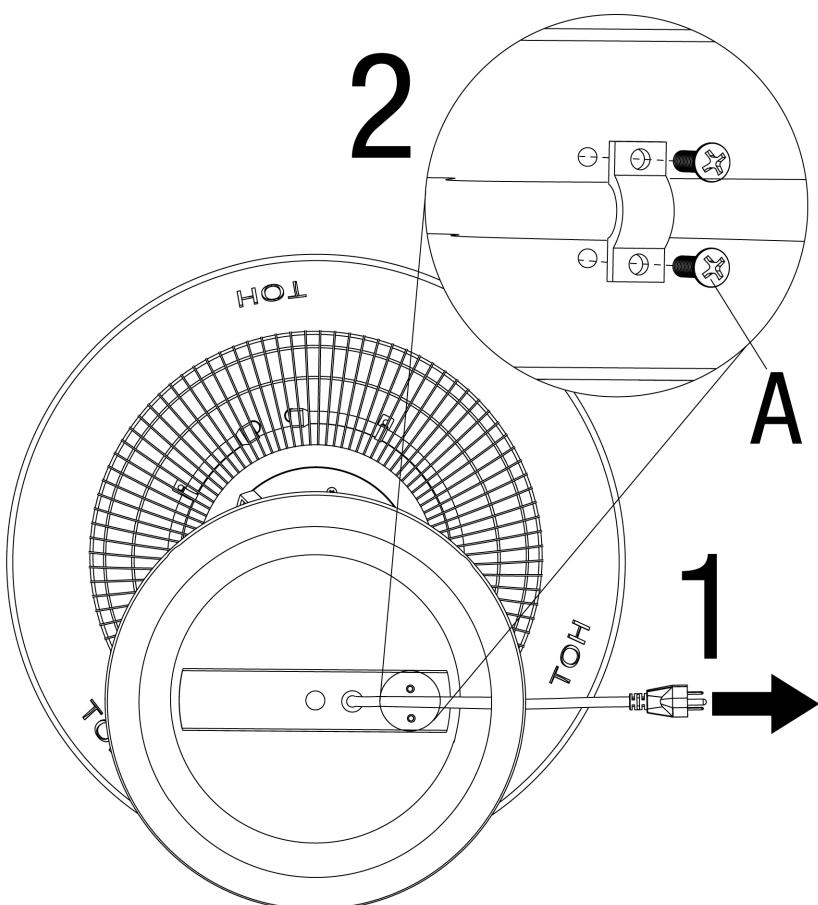

A  x 2

Operating Instructions

NOTE: Heater functions best WITHOUT an extension cord.

1. The short cord is provided to reduce the risk of becoming entangled in or tripping over a longer cord.
2. An extension cord may be used, if care is exercised.
3. If an extension cord is necessary:
 - Use a UL approved, 3 prong plug (grounded) cord shall be no. 16 AWG minimum size and rated not less than 1500 watts.
 - **Never connect two or more extension cords together.**
 - Use the shortest extension cord possible.
 - Keep connections dry and off the ground.
 - Avoid draping the electric heater cord where children or animals could encounter it.

Grounding Instructions

1. This grill must be grounded while in use to protect the operator from electrical shock.
2. The grill is equipped with a 3-conductor cord and a dry GFI (Ground-Fault Interceptor) 3 prong outlet (Figure 1).

Figure 1

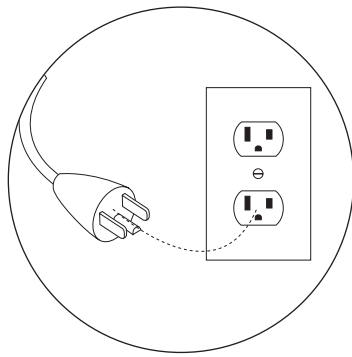

Connecting the power cord to a dry GFI 3 prong outlet.

Before Turning "ON"

1. Make sure all labels, packaging and protective films have been removed from the heater.
2. Heater should be thoroughly inspected before each use, and by a qualified service person at least annually.

Turning "ON"

1. Plug the other end into a dry GFI (Ground-Fault Interceptor) 3 prong outlet, per "Grounding Instructions" section.
2. Push the power button. (Figure 2)
Note: The red LED light will glow while the heater is on.

Note: When restarting the heating element will start up slowly before getting to full power.

Figure 2

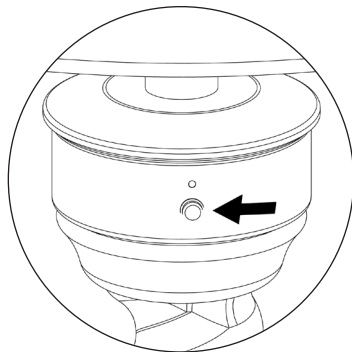

Power button

While Heater is "ON"

⚠ If heater tips over, the heater will automatically turn "OFF".

If heater tips over:

1. IMMEDIATELY unplug power cord from the wall outlet.
2. Carefully turn the heater upright.

⚠ CAUTION: Dome, pole and shroud cover may be hot. Use heat resistant gloves to set heater upright.

3. Inspect heater to ensure no damage.
If no damage continue to next step.
If there is damage call a qualified technician to inspect and make any necessary repairs.

⚠ Do NOT use the heater if there is any sign of damage. A qualified technician should inspect and make any necessary repairs before the heater is used again.

4. Start heater per "Turning 'ON'" instructions.

Turning "OFF"

1. Push the power button. (Figure 2)
2. Unplug the power cord from the wall outlet.

Cleaning and Care

Notices

1. **Abrasive cleaners will damage this product.**
2. **Never use oven cleaner to clean any part of heater.**
3. **Do not clean any heater part in a self cleaning oven. The extreme heat will damage the finish.**
4. **Inspect heater before each use.**
5. **Have heater inspected annually and repairs should be made by a qualified service person.**
6. **Do not clean heater with combustible or corrosive cleaners. Use warm, soapy water.**
7. **Do not paint engine, engine panels or dome.**
8. **This heater should be thoroughly cleaned on a regular basis.**
9. **After a period of storage and/or non use, inspect for any abrasion, wear or cuts to the power cord.**

Cleaning Surfaces

1. Wipe surfaces clean with a solution of water and mild dishwashing detergent or baking soda.
2. Wipe clean with damp cloth.

Note: While cleaning your unit, be sure to keep the area around the heating element dry at all times. Do not submerge the heating element. If the heating element is submerged in water, do NOT use it. It must be replaced.

Maintenance

To enjoy years of outstanding performance from your heater, make sure you perform the following maintenance activities on a regular basis:

1. Keep exterior surfaces clean.
2. Air flow must be unobstructed. Keep circulating air passages around the heating element clean.

Figure 4

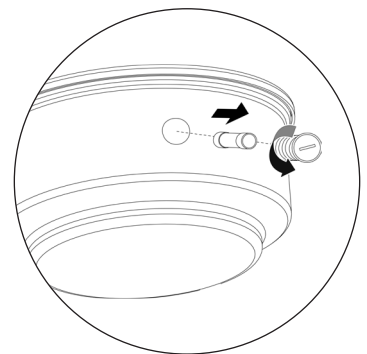

Remove fuse cover

Replacing the Fuse

1. Push the power button. (Figure 2)
2. Unplug the power cord from the wall outlet.
3. Using a screwdriver, remove the fuse cover. (Figure 4)
4. Carefully remove the old fuse, and replace with the new fuse. (Figure 5)

Note: ONLY replace the old fuse with a 250V 15A fuse.

5. Reattach the fuse cover.

Note: Do not over tighten

6. Follow the Turning "ON" instructions or the Storage Instructions.

Figure 5

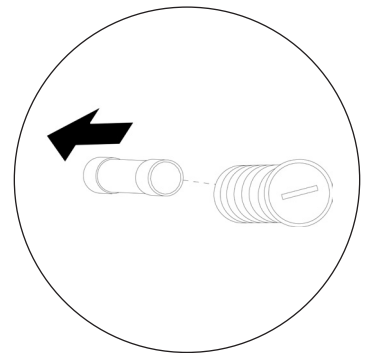

Remove old fuse

Storage

Between Uses and During Periods of Extended Inactivity or When Transporting:

1. Push the power button. (Figure 2)
2. Unplug the power cord from the wall outlet.
3. Store heater upright in an area sheltered from direct contact with inclement weather (such as rain, sleet, hail, snow, dust and debris).
4. If desired, cover heater to protect exterior surfaces and to help prevent build up in air passages.

⚠ Wait until heater is cool before covering.

Product Registration

For faster warranty service, register your product immediately at www.bluerhino.com or call 1.800.762.1142.

Limited Warranty

Blue Rhino Global Sourcing, Inc (“Vendor”) warrants to the original retail purchaser of this product, and to no other person, that if this product is assembled and operated in accordance with the printed instructions accompanying it, then for a period of one (1) year from the date of purchase, all parts in such product shall be free from defects in material and workmanship. Vendor may require reasonable proof of your date of purchase. Therefore, you should retain your sales slip or invoice. This Limited Warranty shall be limited to the repair or replacement of parts, which prove defective under normal use and service and which Vendor shall determine in its reasonable discretion upon examination to be defective. Before returning any parts, you should contact Vendor’s Customer Service Department using the contact information listed below. If Vendor confirms, after examination, a defect covered by this Limited Warranty in any returned part, and if Vendor approves the claim, Vendor will replace such defective part without charge. If you return defective parts, transportation charges must be prepaid by you. Vendor will return replacement parts to the original retail purchaser, freight or postage prepaid.

This Limited Warranty does not cover any failures or operating difficulties due to accident, abuse, misuse, alteration, misapplication, improper installation or improper maintenance or service by you or any third party, or failure to perform normal and routine maintenance on the product as set out in this owner’s manual. In addition, the Limited Warranty does not cover damage to the finish, such as scratches, dents, discoloration, rust or other weather damage, after purchase.

This Limited Warranty is in lieu of all other express warranties. Vendor disclaims all warranties for products that are purchased from sellers other than authorized retailers or distributors, including the warranty of merchantability or the warranty of fitness for a particular purpose. VENDOR ALSO DISCLAIMS ANY AND ALL IMPLIED WARRANTIES, INCLUDING WITHOUT LIMITATION THE IMPLIED WARRANTIES OF MERCHANTABILITY AND FITNESS FOR A PARTICULAR PURPOSE. VENDOR SHALL HAVE NO LIABILITY TO PURCHASER OR ANY THIRD PARTY FOR ANY SPECIAL, INDIRECT, PUNITIVE, INCIDENTAL, OR CONSEQUENTIAL DAMAGES. Vendor further disclaims any implied or express warranty of, and assumes no responsibility for, defects in workmanship caused by third parties.

This Limited Warranty gives the purchaser specific legal rights; a purchaser may have other rights depending upon where he or she lives. Some jurisdictions do not allow the exclusion or limitation of special, incidental or consequential damages, or limitations on how long a warranty lasts, so the above exclusion and limitations may not apply to everyone.

Vendor does not authorize any person or company to assume for it any other obligation or liability in connection with the sale, installation, use, removal, return, or replacement of its equipment, and no such representations are binding on Vendor.

Blue Rhino Global Sourcing, Inc
Winston-Salem, North Carolina USA
(800) 762-1142

Specifications

Certifications:

CSA International Requirement 22.2 No. 46-M1988
UL 1278

Fuel:

Electric

Power:

Maximum 1,200 Watts

Voltage:

120V AC

Frequency:

60 Hz

Net Weight:

16 lbs / 7.2 Kgs

Unit Dimensions:

19.7 in L x 19.7 in W x 37.4 in H / 50 cm x 50 cm x 95 cm

Manufacturer:

Blue Rhino Global Sourcing, Inc

Made In:

China

Troubleshooting

Problem	Possible Cause	Prevention/Cure
Unit will not operate	Not plugged in	Plug cord into grounded outlet
	Fuse is blown	Replace fuse
	Loose wiring	Call Customer Care Center
	Reset Button is not activated	Press restoration button
	Heating Element is worn out	Contact Customer Care at 1.800.762.1142 for new heating element and replacement instructions.

If problems can not be corrected by using these methods, please contact 1.800.762.1142 for assistance.

