

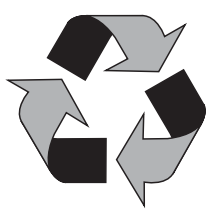

# OWNER'S MANUAL

## LP Gas Outdoor Fireplace

Model No. GAD860SP



Made from 75% Bagasse  
(Environmentally  
Friendly Sugar Cane  
Pulp By-product)

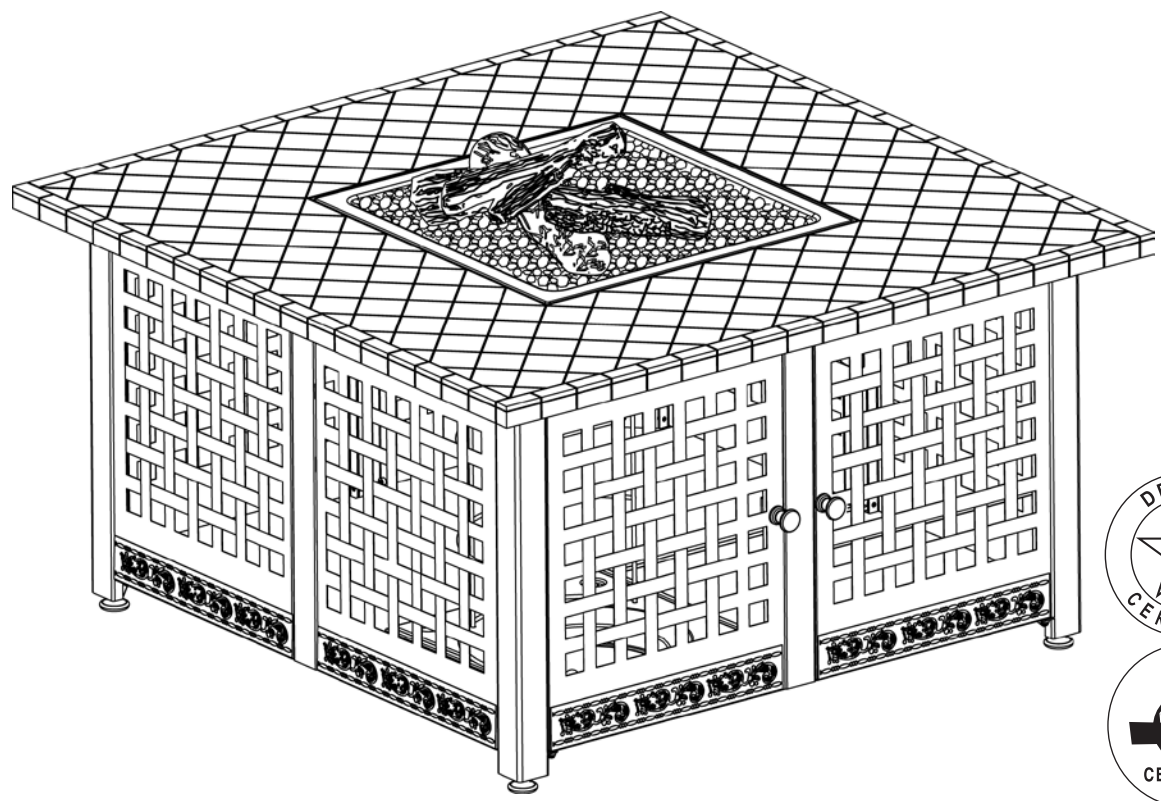

**WARNING**  
FOR YOUR SAFETY:  
For Outdoor Use Only (outside any enclosure)  
Do Not Use For Cooking.

**WARNING**  
FOR YOUR SAFETY:

- ▲ If the information in this manual is not followed exactly, a fire or explosion may result causing property damage, personal injury or loss of life.
- ▲ **WHAT TO DO IF YOU SMELL GAS:**
  - Do not try lighting any appliance.
  - Do not touch any electrical switch; do not use any phone in your building.
  - Immediately call your gas supplier from a neighbor's phone.
  - Follow the gas supplier's instructions.
  - If you cannot reach your gas supplier, call the fire department.
- ▲ Installation and service must be performed by a qualified installer, service agency or gas supplier.
- ▲ Save these instructions for future reference.  
If you are assembling this unit for someone else, give this manual to him or her to read and save for future reference.

**WARNING**  
FOR YOUR SAFETY:

- ▲ Improper installation, adjustment, alteration, service or maintenance can cause injury or property damage.
- ▲ Read the installation, operation and maintenance instructions thoroughly before installing or servicing this equipment.

**DANGER**

If you smell gas -

1. Shut off gas to appliance.
2. Extinguish any open flame.
3. Open lid.
4. If odor continues, keep away from the appliance and immediately call your gas supplier or your fire department.

**WARNING**  
FOR YOUR SAFETY:

1. Do not store or use gasoline or other flammable liquids or vapors in the vicinity of this or any other appliance.
2. An LP cylinder not connected for use shall not be stored in the vicinity of this or any other appliance.

**DANGER**

Never operate this appliance unattended.

**DANGER**

**CARBON MONOXIDE HAZARD**

- This appliance can produce carbon monoxide which has no odor.
- Using it in an enclosed space can kill you.
- Never use this appliance in an enclosed space such as a camper, tent, car or home.

**Table of Contents**

Dangers and Warnings .....	Page 2
Exploded View & Hardware .....	4
Assembly Instructions .....	5
Installing LP Gas Tank .....	8
Insert LP Gas Tank .....	8
Secure LP Gas Tank .....	8
Connect LP Gas Tank .....	8
Disconnect LP Gas Tank .....	8
Operating Instructions .....	9
Checking for Leaks .....	9
Lighting .....	9
Turning Off .....	9
Cleaning and Care .....	9
Inspecting .....	9
Cleaning .....	9
Storing .....	9
Product Registration .....	10
Limited Warranty .....	10
Troubleshooting .....	11

The use and installation of this product must conform to local codes. In absence of local codes, use the latest edition of the *National Fuel Gas Code, ANSI Z223.1/NFPA 54*, or *International Fuel Gas Code*. This appliance, when installed, must be electrically grounded in accordance with local codes, or in the absence of local codes with the *National Electrical Code, ANSI/NFPA 70*, if applicable.

For installation in Canada - these instructions, while generally acceptable do not necessarily comply with the Canadian installation codes, particularly with piping above and below ground. In Canada the installation of this appliance must comply with local codes and/or standard CAN/CGA B149.1 (installation code for propane burning appliances and equipment).

California Proposition 65: Chemicals known to the State of California to cause cancer, birth defects, or other reproductive harm are created by the combustion of propane.

Manufactured in China for: Blue Rhino Global Sourcing, Inc  
Winston-Salem, NC 27105 USA • 1.800.762.1142, www.bluerhino.com

© Blue Rhino Global Sourcing, Inc. All Rights Reserved  
UniFlame® is a Registered Trademark of Blue Rhino Global Sourcing, Inc. All Rights Reserved

**DANGERS and WARNINGS: FOR YOUR SAFETY**

▲ **DANGER:** Failure to follow the dangers, warning and cautions in this manual may result in serious bodily injury or death, or in a fire or an explosion causing damage to property.

**▲ WARNING:**

- ▲ This appliance is for outdoor use only, and shall NOT be used in a building, garage or any other enclosed area.
- ▲ Do NOT operate, light or use this appliance within ten (10) feet (3.05 m) of walls, structures or buildings.
- ▲ For residential use only. This outdoor fireplace is NOT for commercial use.
- ▲ This outdoor fireplace is safety certified for use in the United States and/or Canada only. Do not modify for use in any other location. Modification will result in a safety hazard.
- ▲ Do NOT use this outdoor fireplace for indoor heating. TOXIC carbon monoxide fumes can accumulate and cause asphyxiation.
- ▲ Apartment Dwellers: Check with management to learn the requirements and fire codes for using an LP gas outdoor fireplace in your apartment complex. If allowed, use outside on the ground floor with a ten (10) foot (3.05 m) clearance from any structure. Do not use on or under balconies.
- ▲ This outdoor fireplace is for use with liquid propane (LP) gas only. The conversion to or attempted use of natural gas in this outdoor fireplace is dangerous and will void your warranty.
- ▲ LP gas is flammable and hazardous if handled improperly. Become aware of the characteristics before using any LP gas product.
  - a. LP gas is explosive under pressure, heavier than air, and settles and pools in low areas.
  - b. LP gas in its natural state has no odor. For your safety, an odorant is added that smells like rotten cabbage.
  - c. Contact with LP gas can cause freeze burns to skin.
- ▲ LP gas tank needed to operate. Only tanks marked “propane” may be used.
  - a. The LP gas supply tank must be constructed and marked in accordance with the *Specifications for LP gas LP gas tanks of the U.S. Department of Transportation (DOT) or the National Standard of Canada, CAN/CSA-B339, LP gas tanks, Spheres and Tubes for the Transportation of Dangerous Goods; and Commission.*
  - b. LP gas tank must be arranged for vapor withdrawal.
  - c. The LP gas tank must have a listed overfilling prevention device (OPD) and a QCCI or Type I (CGA810) LP gas tank connection.
  - d. The LP gas tank must have a tank collar to protect the tank valve.
  - e. Never use an LP gas tank with a damaged body, valve, collar or footing.
  - f. Dented or rusted LP gas tanks may be hazardous and should be checked by your LP gas supplier prior to use.
  - g. The LP gas tank should not be dropped or handled roughly.
  - h. Tanks must be stored outdoors, out of the reach of children and must not be stored in a building, garage or any other enclosed area. Your LP gas tank must never be stored where temperatures can reach over 125°F.
  - i. Do not insert any tool or foreign object into the valve outlet or safety relief valve. You may damage the valve and cause a leak. Leaking propane may result in explosion, fire, severe personal injury or death.
  - j. Never keep a filled LP gas tank in a hot car or car trunk. Heat will cause the gas pressure to increase, which may open the relief valve and allow gas to escape.
  - k. Place dust cap on valve outlet whenever the LP gas tank is not in use. Only install the type of dust cap on the LP gas tank valve outlet that is provided with the LP gas tank valve. Other types of caps or plugs may result in leakage of propane.
  - l. Do not store a spare LP gas tank under or near this appliance.
  - m. Never fill the tank beyond 80 percent full.
- ▲ Your outdoor fireplace has been checked at all factory connections for leaks. Recheck all connections as described in the “Operating Instructions” section of this manual, as movement in shipping can loosen connections.
- ▲ Check for leaks even if your unit was assembled for you by someone else.
- ▲ Do not operate if gas leak is present. Gas leaks may cause a fire or explosion.
- ▲ You must follow all leak-checking procedures before operating. To prevent fire or explosion hazard when testing for a leak:
  - a. Always perform leak test before lighting the outdoor fireplace and each time the tank is connected for use.
  - b. No smoking. Do not use or permit sources of ignition in the area while conducting a leak test.
  - c. Conduct the leak test outdoors in a well-ventilated area.
  - d. Do not use matches, lighters or a flame to check for leaks.
  - e. Do not use outdoor fireplace until any and all leaks are corrected. If you are unable to stop a leak, disconnect the LP gas supply. Call a gas appliance serviceman or your local LP gas supplier.
- ▲ Do not store or use gasoline or other flammable liquids or vapors within 25 feet (7.62 m) of this appliance.
- ▲ Do not use in an explosive atmosphere. Keep outdoor fireplace area clear and free from combustible materials, gasoline and other flammable vapors and liquids.
- ▲ This outdoor fireplace is NOT to be operated by children.
- ▲ This outdoor fireplace is NOT to be used in or on boats or recreational vehicles.
- ▲ Do NOT connect to a remote gas supply.
- ▲ Never attempt to attach this outdoor fireplace to the self-contained LP gas system of a camper trailer, motor home or house.
- ▲ Always use in accordance with all applicable local, state and national codes. Contact your local fire department for details on outdoor burning.
- ▲ When using this outdoor fireplace, exercise the same precautions you would with any open fire.
- ▲ The use of alcohol, prescription or non-prescription drugs may impair the consumer’s ability to properly assemble or safely operate this outdoor fireplace.
- ▲ Do NOT use this outdoor fireplace without reading the entire “Owner’s Manual”.
- ▲ Do NOT burn solid fuels such as: wood, charcoal briquets, lump charcoal, manufactured logs, driftwood, trash, leaves, paper, cardboard, plywood, painted or stained or pressure treated wood in this outdoor fireplace.
- ▲ It is essential to keep the outdoor fireplace’s valve compartment, burners, and circulating air passages clean. Inspect outdoor fireplace before each use.
- ▲ Do NOT use this outdoor fireplace until it is COMPLETELY assembled and all parts are securely fastened and tightened.
- ▲ Do NOT use this outdoor fireplace near automobiles, trucks, vans or recreational vehicles.
- ▲ Do NOT use this outdoor fireplace under any overhead or near any unprotected combustible constructions. Avoid using near or under overhanging trees and shrubs.
- ▲ Always use this outdoor fireplace on a hard, level, non-combustible surface such a concrete, rock or stone. An asphalt or blacktop surface may not be acceptable for this purpose.
- ▲ Do NOT use this outdoor fireplace for cooking.
- ▲ Do NOT use this outdoor fireplace if any part has been under water. Immediately call a qualified service technician to inspect the appliance and to replace any part or control system and any gas control which has been under water.
- ▲ Do NOT wear flammable or loose clothing when operating this outdoor fireplace.
- ▲ Do NOT use in windy conditions.
- ▲ Never lean over this outdoor fireplace when lighting or when in use.
- ▲ Do NOT use this outdoor fireplace unless burner is securely in place.
- ▲ Keep all electrical cords away from outdoor fireplace during use.
- ▲ Certain areas of this outdoor fireplace when in use will become too hot to touch. To avoid burns, do not touch hot surfaces until the unit has cooled (about 45 minutes) unless you are wearing protective gear (insulated pot holder or heat resistant gloves or mittens).

- ▲ Do NOT leave a lit outdoor fireplace unattended, especially around children and pets.
- ▲ Children and adults should be alerted to the hazards of high surface temperatures and should stay away to avoid burns or clothing ignition.
- ▲ Young children should be carefully supervised when they are in the area of the appliance.
- ▲ Clothing or other flammable materials should not be hung from the appliance or placed on or near the appliance.
- ▲ Any guard or other protective device removed for servicing the appliance must be replaced prior to operating the appliance.
- ▲ Cover must be removed when burner is in operation.
- ▲ Do not attempt to move outdoor fireplace when in use. Allow the outdoor fireplace to cool before moving or storing.
- ▲ This outdoor fireplace should be thoroughly cleaned and inspected on a regular basis. Clean and inspect the hose before each use of the appliance. If there is evidence of abrasion, wear, cuts, or leaks, the hose must be replaced prior to the appliance being put into operation.
- ▲ This outdoor fireplace should be inspected at least annually by a qualified service person. Depending on amount of use, more frequent cleaning may be required. Do not operate until all parts have been repaired or replaced.
- ▲ Use only the regulator and hose assembly provided. The replacement regulator and hose assembly shall be that specified by the manufacturer.
- ▲ Use only Blue Rhino Global Sourcing, Inc factory authorized parts. The use of any part that is NOT factory authorized can be dangerous and will void your warranty.
- ▲ Storage of this outdoor fireplace indoors is permissible only if the tank is disconnected, removed from the outdoor fireplace and properly stored outdoors.
- ▲ Do not attempt to disconnect the gas regulator from the tank or any gas fitting while the outdoor fireplace is in use.
- ▲ If the outdoor fireplace is not in use, the gas must be turned off at the supply tank.
- ▲ The pressure regulator is set for 10.5 inches of water column (pressure).
- ▲ The maximum inlet gas pressure for this outdoor fireplace is 11 inches of water column pressure.
- ▲ Turn LP gas tank valve closed, disconnect gas regulator prior and during pressure testing of the gas supply piping system at test pressures equal to or less than 1/2 psi (3.5 kPa).
- ▲ Do NOT sit on the mantle.
- ▲ Do not throw anything onto the fire when the unit is in operation.
- ▲ Fire logs and lava rock are very hot, keep the children or pets away at a safe distance.
- ▲ The opening of the tank collar should face toward the door side for easy access.
- ▲ Do NOT store any combustible materials in the base enclosure.
- ▲ Use protective gloves when assembling this product.
- ▲ Do not force parts together as this can result in personal injury or damage to the product.
- ▲ Deaths, serious injury or damage to property may occur if the above is not followed exactly.

**Parts List**

<b>1</b>	Cement Log (4)	55-05-432 55-05-433 55-05-434 55-05-435
<b>2</b>	Lava Rock	55-05-443
<b>3</b>	Lava Rock Grid	55-05-444
<b>4</b>	Side Panel (6)	58-05-028
<b>5</b>	Bowl Assembly*	55-05-430
<b>6</b>	Burner*	55-05-431
<b>7</b>	Igniter*	55-05-441
<b>8</b>	Control Knob*	55-05-436
<b>9</b>	Regulator/Hose Assembly*	55-05-452
<b>10</b>	Hearth	58-05-025
<b>11</b>	Back Leg (2)	55-05-694
<b>12</b>	Middle Support Leg (3)	55-05-702
<b>13</b>	Tank Guard	55-05-458
<b>14</b>	LP Gas Tank Retaining Chain	55-05-447
<b>15</b>	LP Gas Tank Tray Peg	55-05-449
<b>16</b>	Base Support Bar	55-05-429
<b>17</b>	Left Front Leg	55-05-700
<b>18</b>	Left Door	58-05-026
<b>19</b>	Door Support Leg	55-05-698
<b>20</b>	Right Door	58-05-027
<b>21</b>	Right Front Leg	55-05-704
<b>22</b>	Door Knob (2)*	55-05-697
<b>23</b>	Base*	55-05-428
<b>24</b>	LP Gas Tank Tray*	55-05-448
<b>25</b>	LP Gas Tank Shield	55-05-458
<b>26</b>	Foot (4)	55-05-692
<b>27</b>	Cover (not shown)	55-05-693

\* Pre-assembled

**Exploded View**

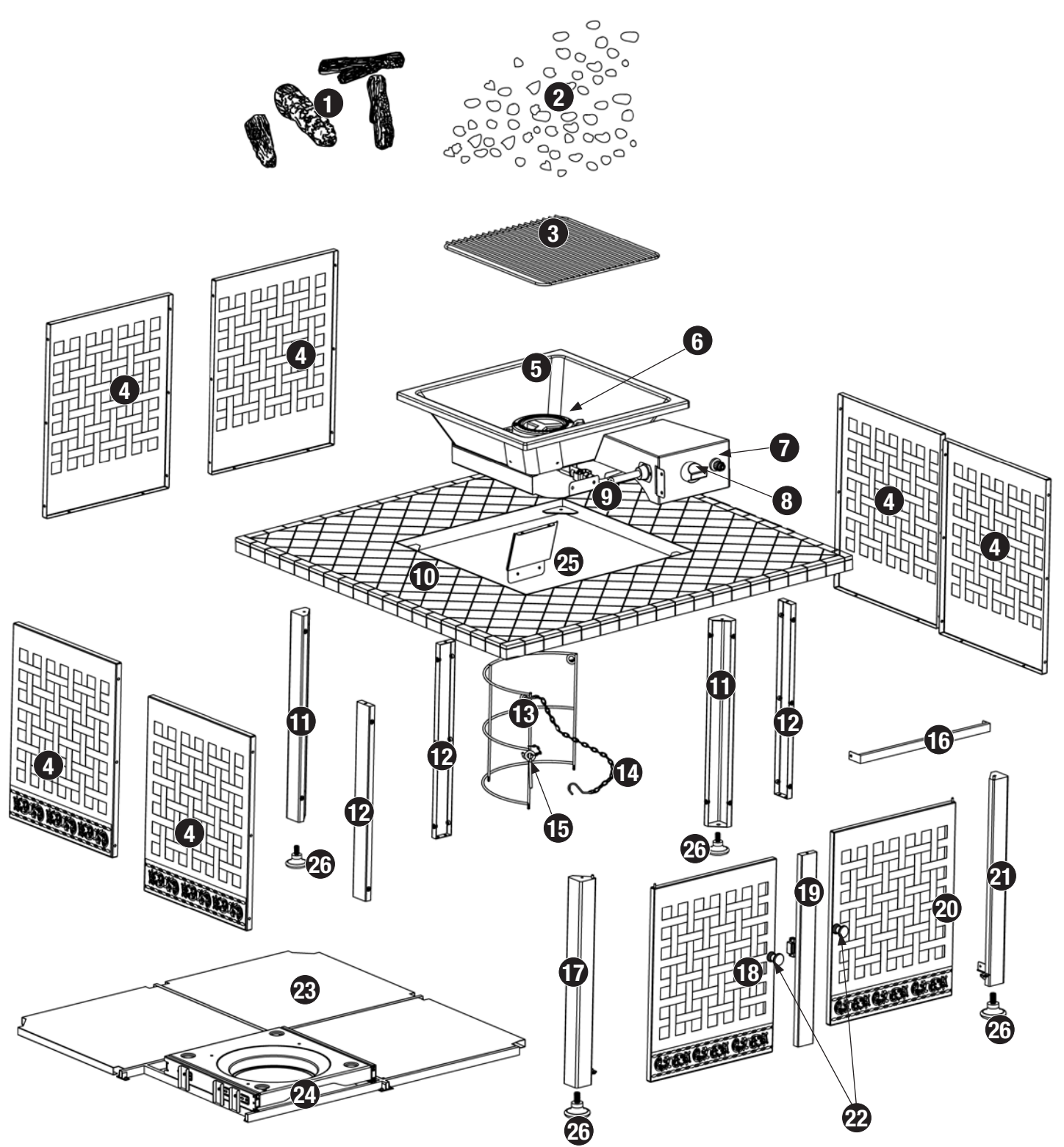

**Hardware**

<b>A</b>	Screw	M5x10 Black Nickel Plated Truss Head	68 pcs
<b>B</b>	Screw	M5x10 Black Nickel Plated Hex	9 pcs
<b>C</b>	Screw	ø4x16 Black Nickel Plated Truss Head	2 pcs
<b>D</b>	Wing Nut	ø5 Black Nickel Plated	3 pcs
<b>E</b>	AA Battery	1.5 V AA Battery	1 pc

**Tools Required for Assembly (Included)**

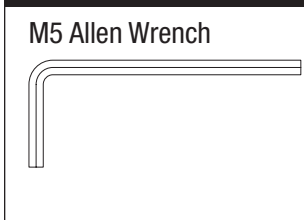

**Tools Required for Assembly (Not Included)**

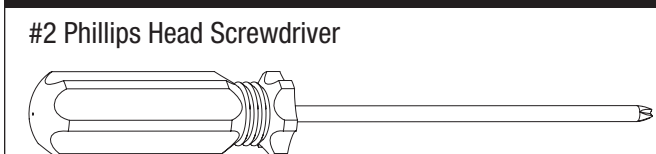

## Assembly Instructions

### 1 DO NOT RETURN PRODUCT TO STORE.

For assistance call 1.800.762.1142 toll free. Please have your owner's manual and model number available for reference.

For Easiest Assembly:

- To avoid losing any small components or hardware, assemble your product on a hard level surface that does not have cracks or openings.
- Clear an area large enough to layout all components and hardware.
- When applicable, tighten all hardware connections by hand first. Once the step is completed go back and fully tighten all hardware.
- Follow all steps in order to properly assemble your product.

To complete assembly you will need:

- (1) Leak Detection Solution (Instructions on how to make solution are included in the "Operating Instructions" section of this manual)
- (1) Precision Filled LP Gas Grill Tank with Acme Type 1 external threaded valve connection (4-5 gallon size)

Typical assembly: approximately 1 (one) hour.

### 2 Attach Bowl Assembly

Note: The control panel must line up with the two holes on the mantel frame.

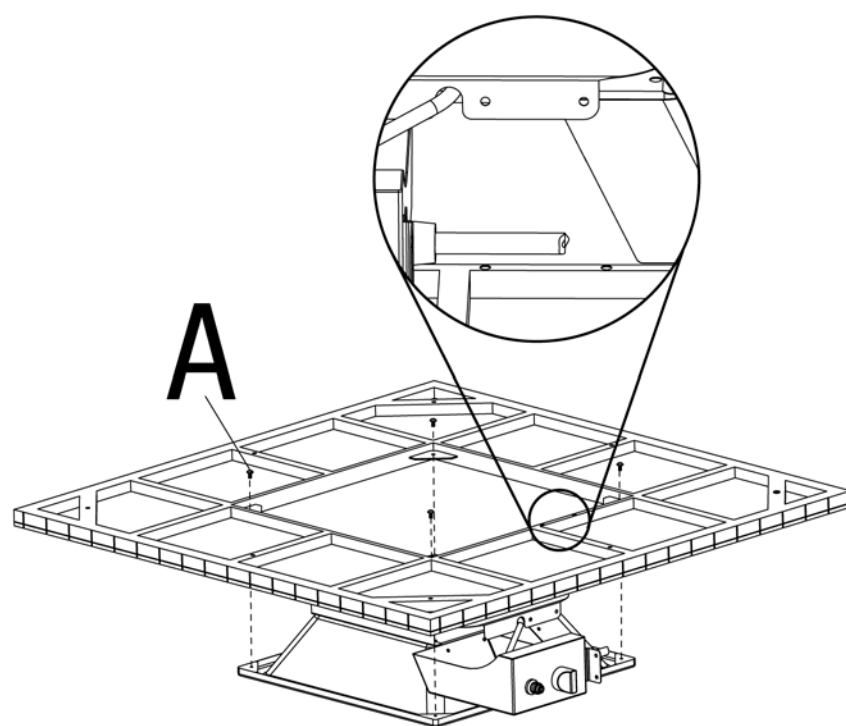

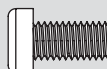
A  x 4

### 3 Attach LP Gas Tank Shield

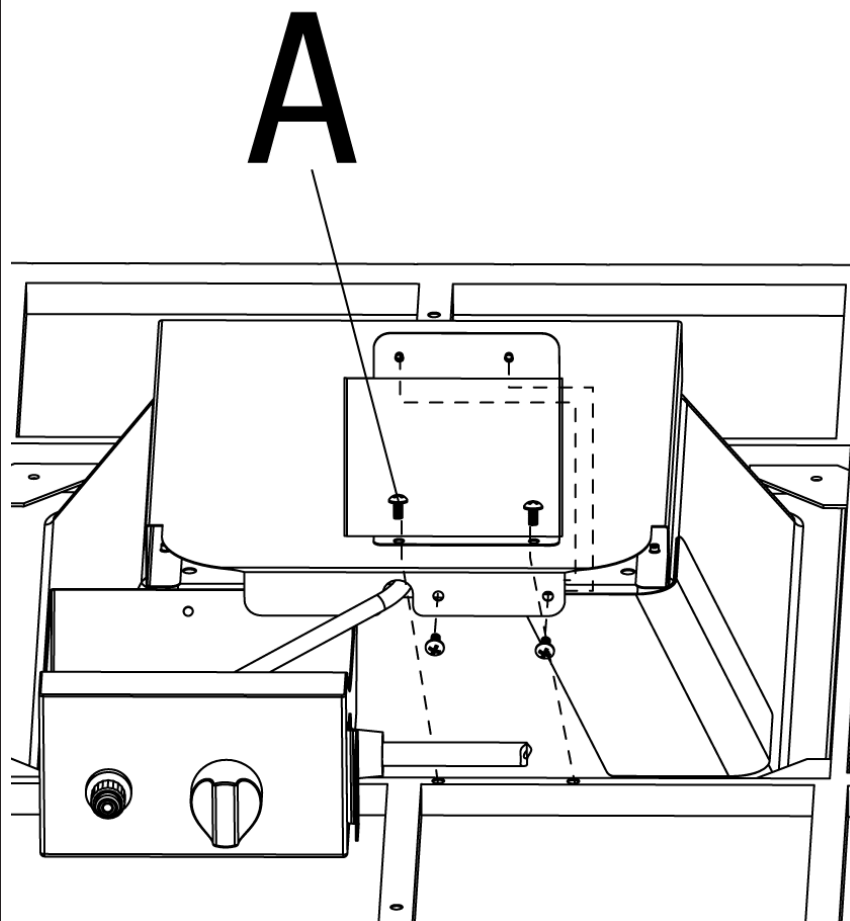

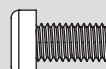
A  x 4

### 4 Attach Side Panels, Back Legs and Middle Support Leg

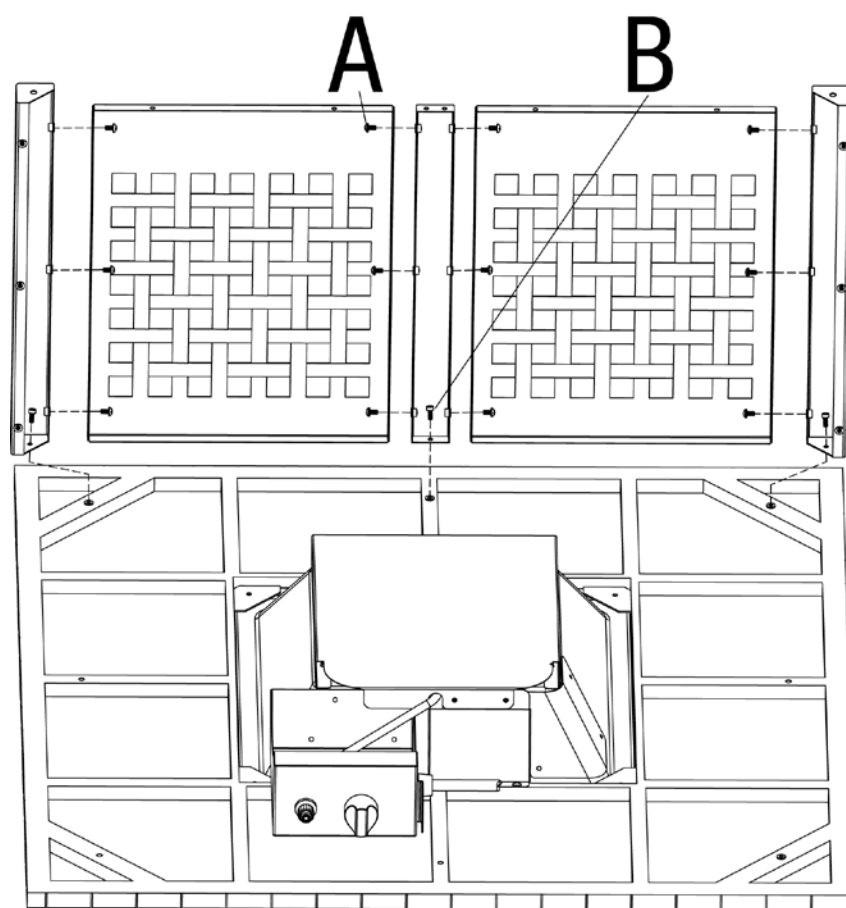

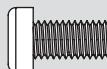
A  x 12

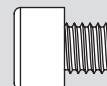
B  x 3

Assembly Instructions (continued)

5

Attach Side Panels, Left Front Leg and Middle Support Leg

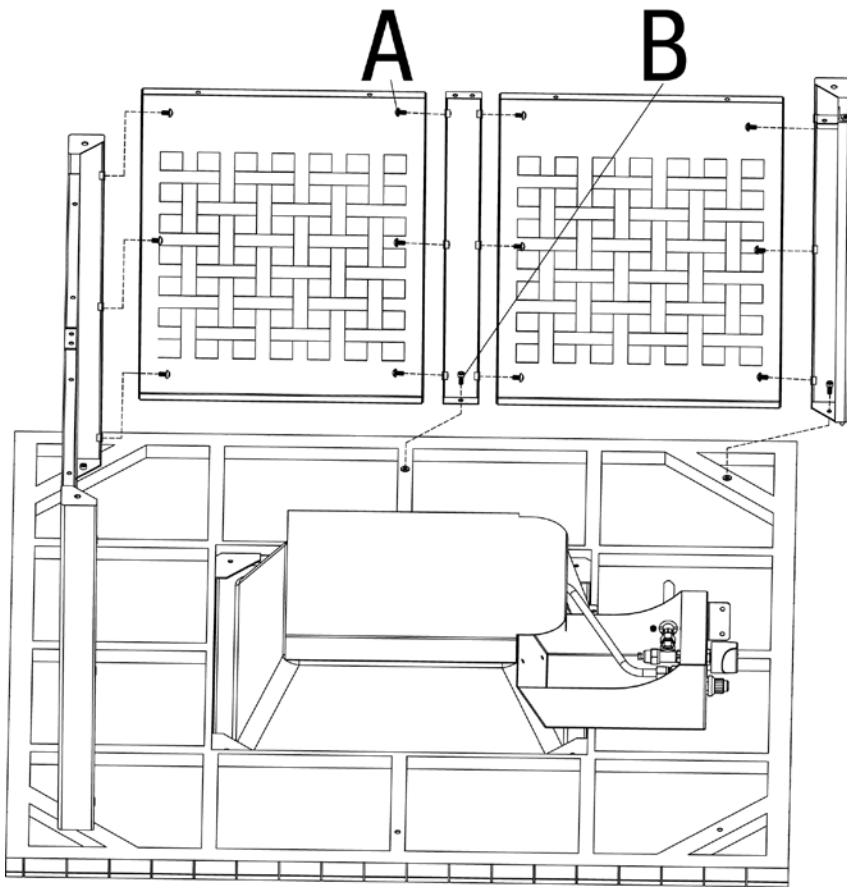

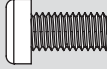
A  x 12

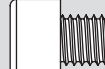
B  x 2

6

Attach Side Panels, Right Front Leg and Middle Support Leg

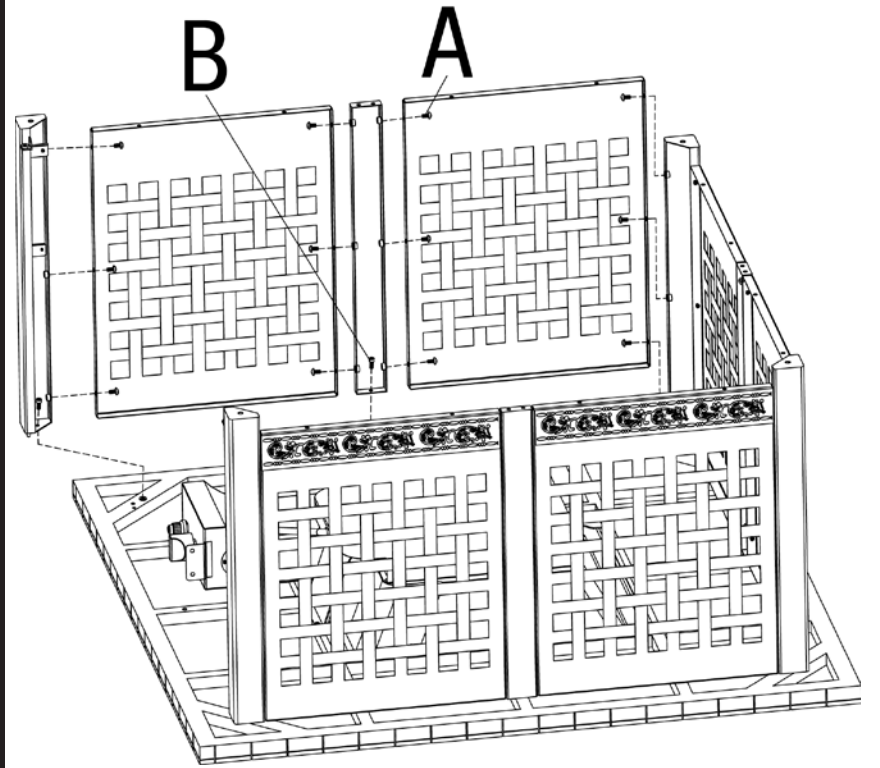

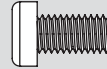
A  x 12

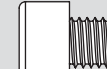
B  x 2

7

Attach Base and Feet

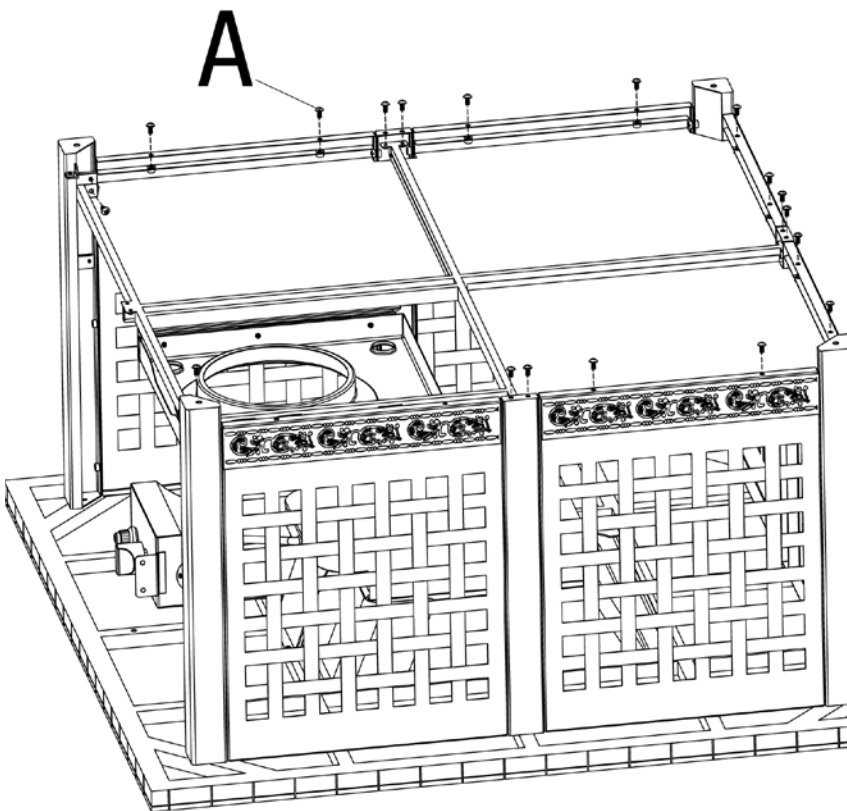

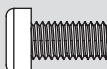
A  x 18

8

Attach Door Support Leg

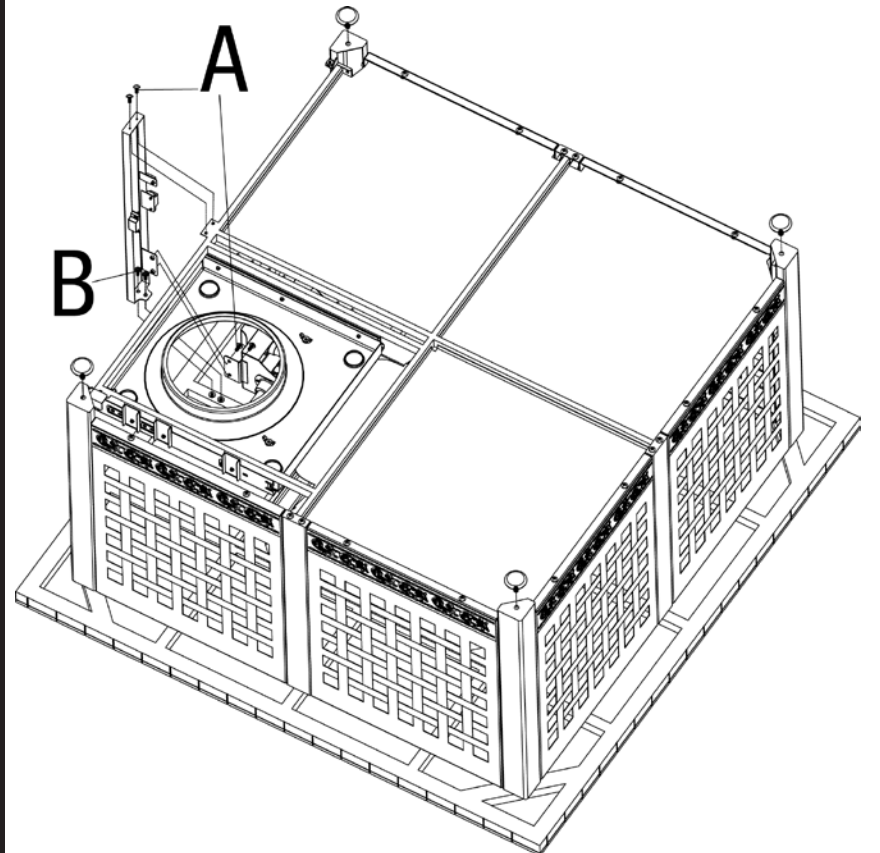

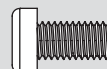
A  x 4

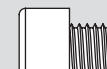
B  x 2

9

### Attach Tank Guard

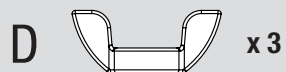
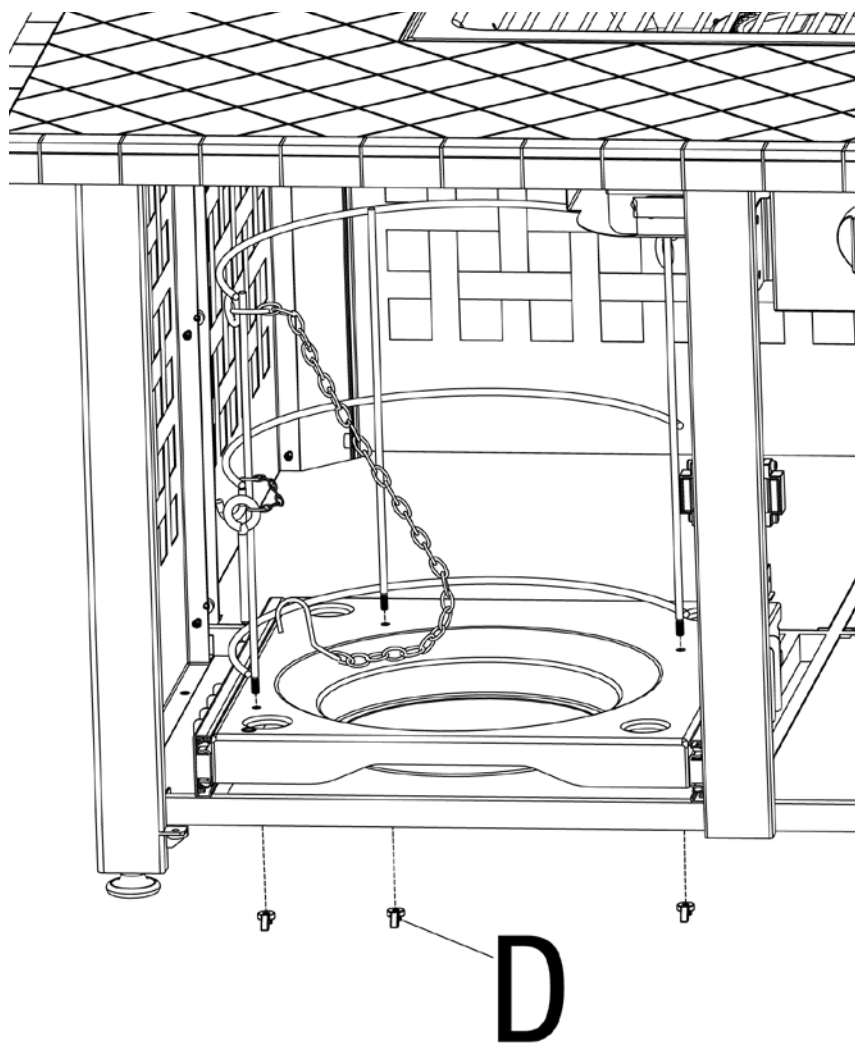

10

### Attach Base Support Bar

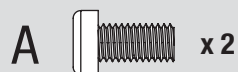
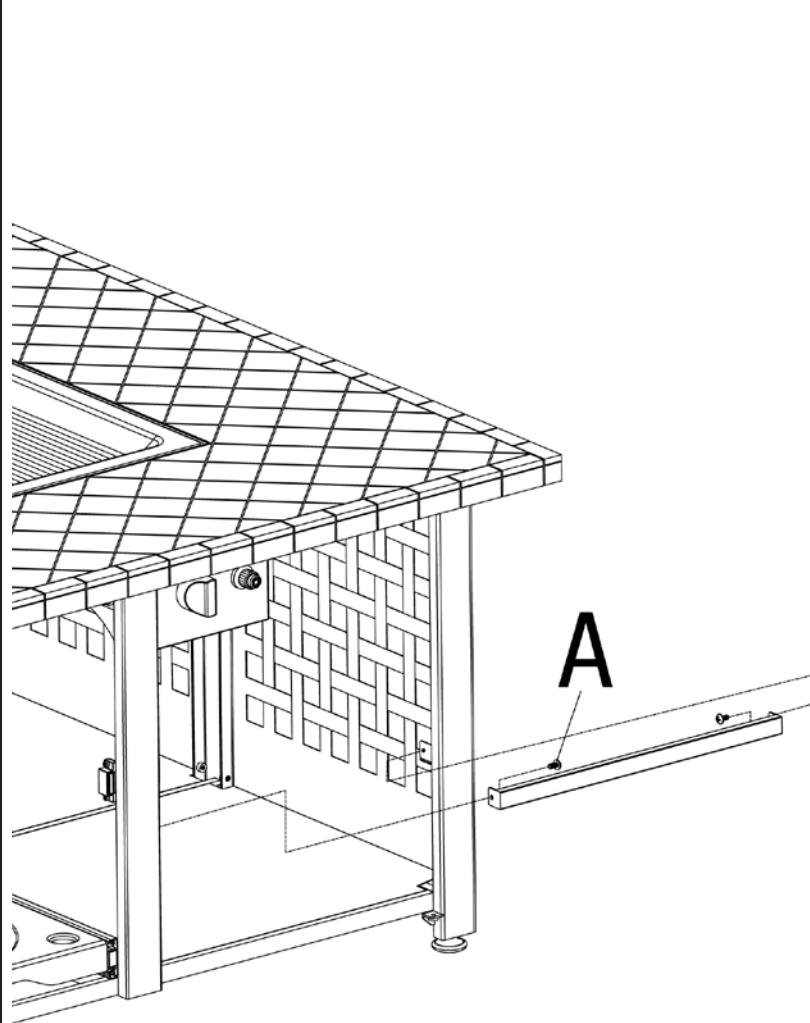

11

### Attach Doors

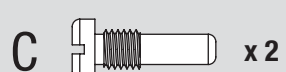
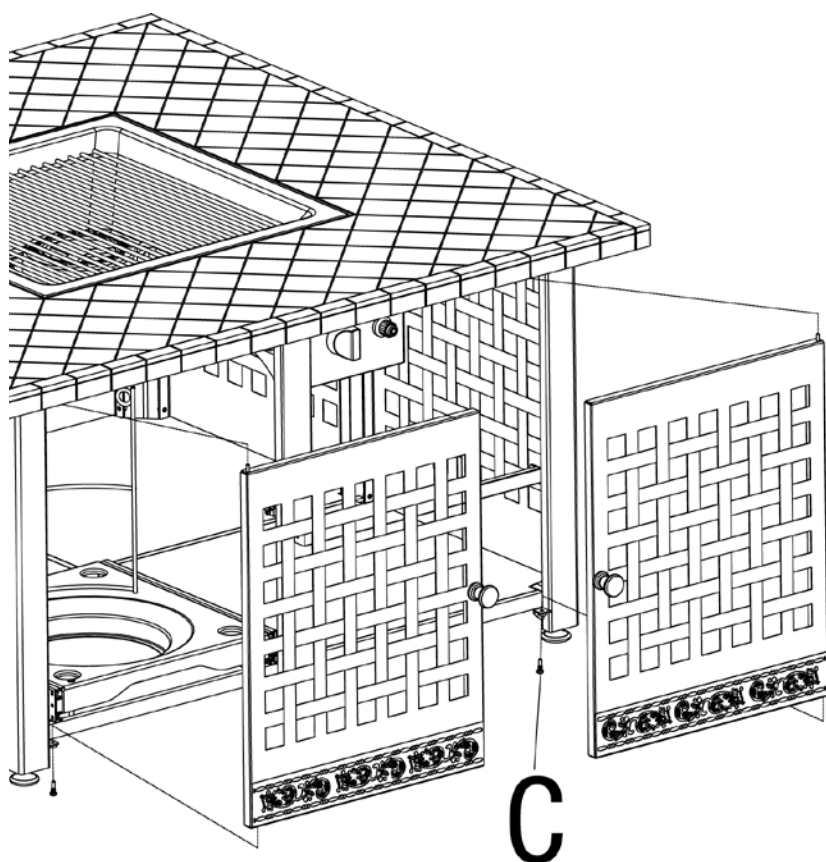

12

### Place Wood Grid and Lava Rocks

Do NOT dump lava rocks out of package. Carefully place lava rocks by hand so dust does not clog burner.

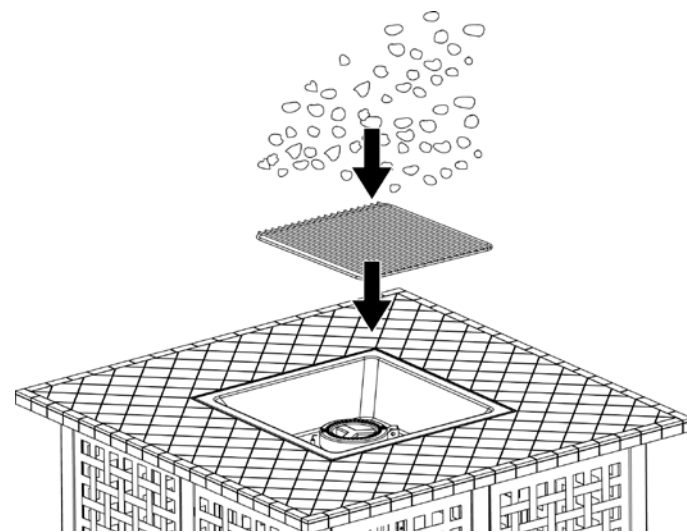

### Place Cement Logs

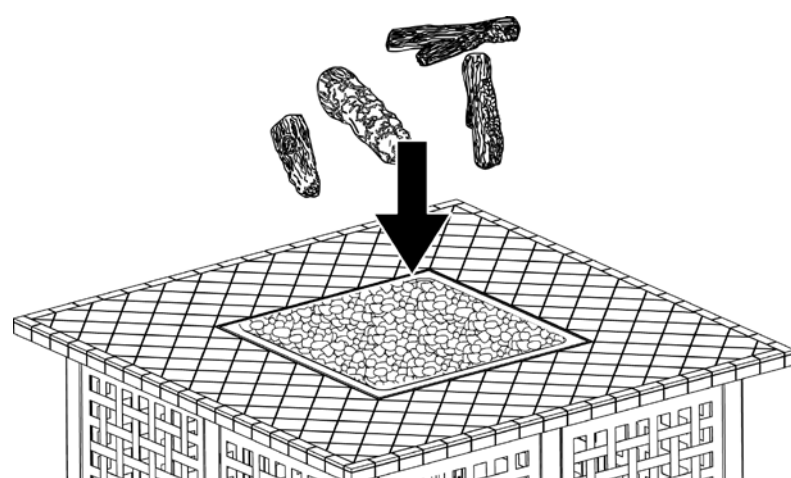

**Assembly Instructions (continued)**

**13 Insert Battery**

*Note:* Remove plastic wrapper before installing battery.

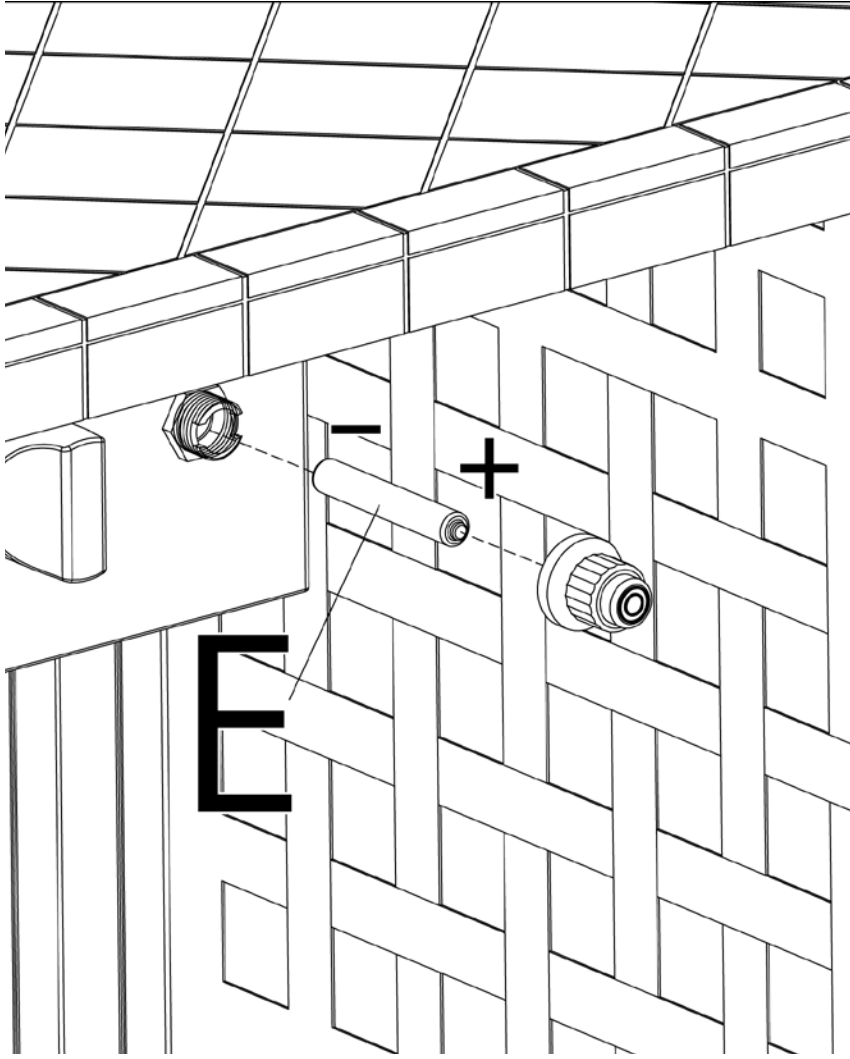

E  x 1

**Installing LP Gas Tank**

To operate you will need (1) precision-filled standard grill LP gas tank (20#) with external valve threads.

*Note:* An empty standard grill LP gas tank weighs approximately 18 lbs. A precision-filled standard grill LP gas tank should weigh no more than 38 lbs.

**⚠ Caution: LP gas tank must be properly disconnected and removed prior to moving this grill.**

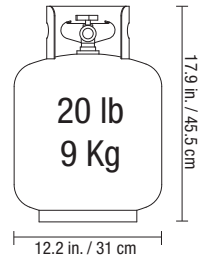

**Need a tank of gas?** Try tank exchange service. It's easy, fast, safe, and available at tens of thousands of conveniently located retail outlets nationwide. You can purchase a new full tank or exchange your empty for a precision filled one.

**Insert LP Gas Tank**

**⚠ WARNING: Make sure LP gas tank valve is closed. Close by turning valve clockwise.**

Place precision filled LP gas tank upright into hole in the base of the outdoor fireplace so it is arranged for vapor withdrawal.

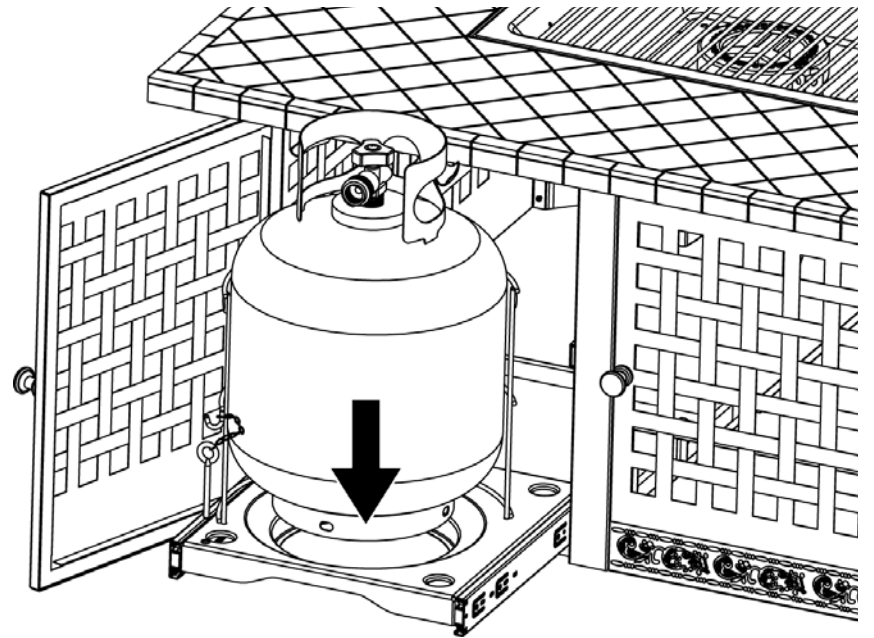

**Secure LP Gas Tank**

Secure tank by sliding tank retainer chain around the LP gas tank and insert peg into LP gas tank tray.

*Note:* Peg must be inserted into LP gas tank when tank is in LP gas tank tray.

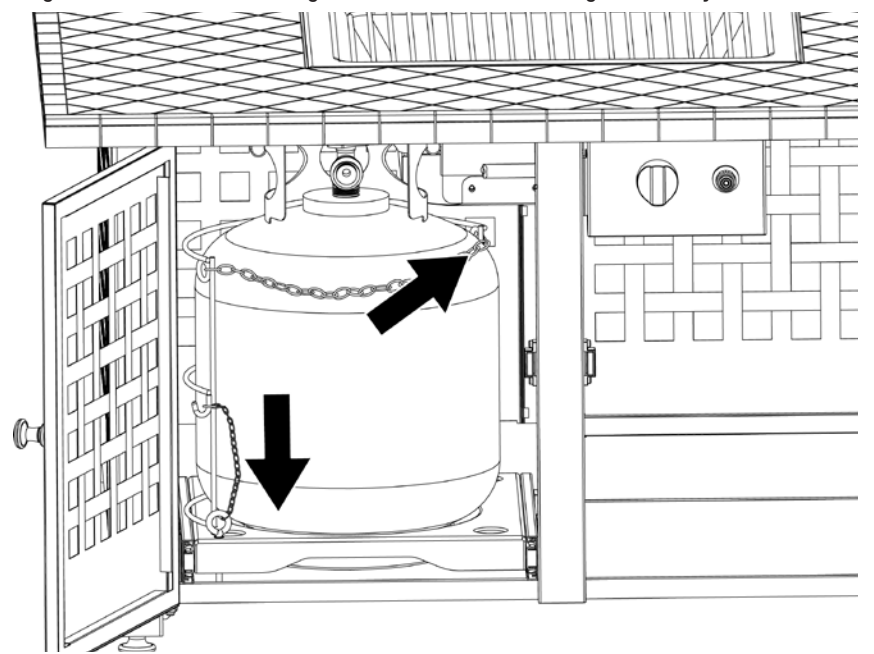

**Connect LP Gas Tank**

Before connecting, be sure that there is no debris caught in the head of the LP gas tank, head of the regulator valve or in the head of the burner and burner ports.

Connect regulator/hose assembly to tank by turning knob clockwise until it stops.

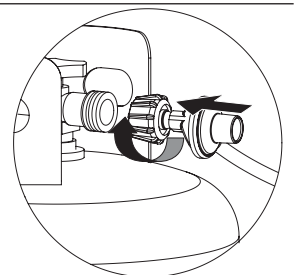

**Disconnect LP Gas Tank**

Before disconnecting make sure the LP gas tank valve is "CLOSED".

Disconnect regulator/hose assembly from LP gas tank by turning knob counterclockwise until it is loose.

**⚠ Caution: LP gas tank must be properly disconnected and removed prior to moving this grill.**

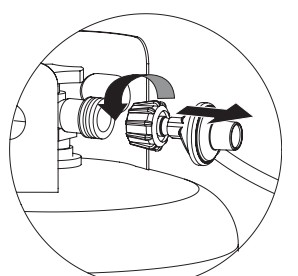



## Operating Instructions

### Checking for Leaks

**▲ WARNING: Before using this outdoor fireplace, make sure you have read, understand and are following all information provided in the Dangers and Warnings presented on page 2. Failure to follow those instructions can cause death, serious injury or property damage.**

#### Burner Connections

1. Make sure the regulator valve and hose connections are securely fastened to the burner and the tank.

If your unit was assembled for you, visually check the connection between the burner venturi pipe and orifice. Make sure the burner venturi pipe fits over the orifice.

**▲ WARNING: Failure to inspect this connection or follow these instructions could cause a fire or an explosion which can cause death, serious bodily injury, or damage to property.**

2. Please refer to diagram for proper installation. (Figures 1 and 2)
3. If the burner pipe does not rest flush to the orifice, please contact 1.800.762.1142 for assistance.

#### Tank/Gas Line Connection

1. Make 2-3 oz. of leak solution by mixing one part liquid dishwashing soap with three parts water.
2. Make sure control knobs are "OFF" position. (Figure 3)
3. Connect LP gas tank per "Installing LP Gas Tank" section.
4. Turn LP gas tank valve to "OPEN".
3. Spoon several drops of solution, or use squirt bottle, at all "X" locations (Figures 1 and 2).
  - a. If any bubbles appear remove the LP gas tank and reconnect, making sure the connection is secure.
  - b. If you continue to see bubbles after several attempts, remove the LP gas tank per "Disconnect LP Gas Tank" instructions, and contact 1.800.762.1142 for assistance.
  - c. If no bubbles appear after one minute, wipe away solution and proceed.

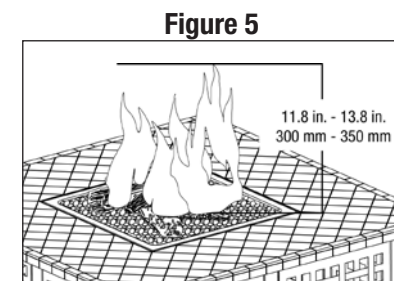
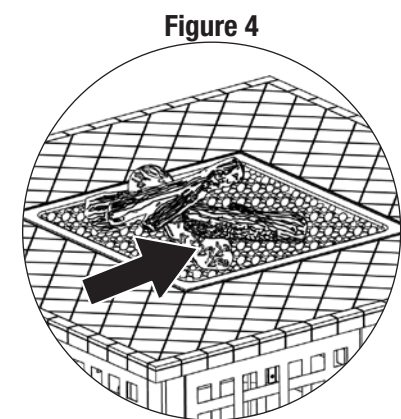
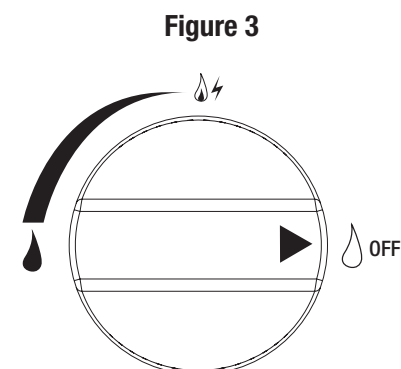
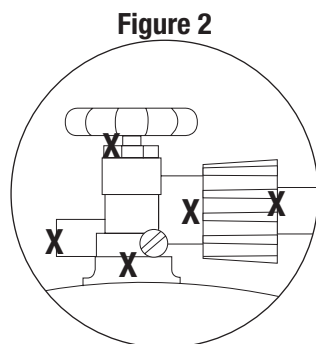
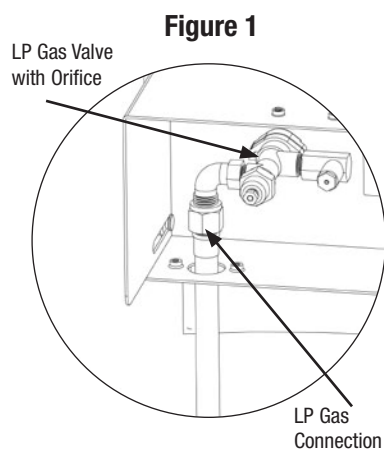

### Lighting

**▲ Caution: Keep outdoor gas cooking appliance area clear and free from combustible materials, gasoline and other flammable vapors and liquids.**

**▲ Caution: Do not obstruct the flow of combustion and ventilation air.**

**▲ Caution: Check and clean burner/venturi tubes for insects and insect nests. A clogged tube can lead to a fire beneath the grill.**

**▲ Caution: Attempting to light the burner with the lid closed may cause an explosion.**

1. Make sure all labels, packaging and protective films have been removed from the outdoor fireplace.
2. Make sure there are no obstructions of airflow to the burners. Spiders and insects can nest within and clog the burner / venturi tube at the orifice. A clogged burner tube can lead to a fire beneath the appliance.
2. Control knob must be in the OFF position. (Figure 3)
3. Connect LP gas tank per "Connect LP Gas Tank" instructions.
4. Turn LP gas tank valve to "OPEN".
5. Push and turn control knob to LOW.
6. Press the (electronic igniter) button and hold for up to 5 seconds to light burner.
7. Release control knob after 45 seconds.
8. If ignition does not occur in 45 seconds, turn burner control knob OFF, wait 5 minutes, and repeat lighting procedure.
9. If igniter does not light burner:
  - a. Clear small area of lava rocks away from the burner.
  - b. Wearing heat resistant gloves, position a lit long match or long lit butane lighter near the side of the burner.

c. Turn control knob counterclockwise to LOW.

d. Remove long match/long butane lighter once lit.

**▲ CAUTION: After Lighting - Using a shovel and heat resistant gloves, carefully move the lava rocks back to their proper position, being careful to avoid the flame.**

9. After lighting, observe the burner flame, make sure all burner ports are lit and flame height matches illustration. (Figure 5)

10. Adjust flame to desired height with the control knob.

**▲ Caution: If burner flame goes out during operation, immediately turn the control knob OFF and open lid to let the gas clear for 5 minutes before re-lighting.**

### Turning Off

1. Turn LP gas tank valve to "CLOSED".

2. Turn all control knobs to the "OFF" position.

*Note:* A "poof" sound is normal as the last of the LP gas is burned.

3. Disconnect LP gas tank per "Disconnect LP Gas Tank" instructions.

## Cleaning and Care

### ▲ CAUTION:

1. All cleaning and maintenance should be done when outdoor fireplace is cool and with the fuel supply disconnected.
2. DO NOT clean any outdoor fireplace part in a self cleaning oven. The extreme heat will damage the finish.
3. Do not enlarge valve orifices or burner ports when cleaning the valves or burners.

### Notices

1. This outdoor fireplace should be thoroughly cleaned and inspected on a regular basis.
2. Abrasive cleaners will damage this product.
3. Never use oven cleaner to clean any part of outdoor fireplace.

### Before Each Use:

1. Keep the outdoor fireplace area clean and free from any combustible materials, gasoline, and other flammable vapors and liquids.
2. Do not obstruct the flow of the combustion of LP and the ventilation air.
3. Keep the ventilation opening(s) of the LP gas tank area free and clear from debris.
4. Visually check the burner flames to make sure your outdoor fireplace is working properly.
5. See sections below for proper cleaning instructions.
6. Check all gas connections for leaks.
7. Check components for any signs of damage or rust.
8. Check and clean the burner/venturi tubes for insects and insect nests. A clogged tube can lead to a fire beneath the outdoor fireplace.
9. If damage to any component is detected, do NOT operate until repairs are executed.

### Cleaning Surfaces

1. Wipe surfaces clean with mild dishwashing detergent or baking soda mixed with water.
2. For stubborn surfaces use a citrus based degreaser and a nylon scrubbing brush.
3. Rinse clean with water.
4. Allow to air dry.

### Before Storing

1. Turn control knob to OFF and LP gas tank valve to "CLOSED".
2. Clean all surfaces.
3. Lightly coat the burners with cooking oil to prevent excess rusting.
4. If storing the outdoor fireplace indoors, disconnect the LP tank, see "Disconnect LP Gas Tank" section, and leave the LP gas tank OUTDOORS.
5. Place the protective cap cover on the LP tank and store the tank outdoors in a well ventilated area out of direct sunlight.
6. Cover outdoor fireplace with a durable vinyl cover designed to fit this unit.
7. Store in a cool and dry location away from children and pets.



## Product Registration

For faster warranty service, register your product immediately at [www.bluerhino.com](http://www.bluerhino.com) or call 1.800.762.1142.

## Limited Warranty

Blue Rhino Global Sourcing, Inc (“Vendor”) warrants to the original retail purchaser of this product, and to no other person, that if this product is assembled and operated in accordance with the printed instructions accompanying it, then for a period of one (1) year from the date of purchase, all parts in such product shall be free from defects in material and workmanship. Vendor may require reasonable proof of your date of purchase. Therefore, you should retain your sales slip or invoice. This Limited Warranty shall be limited to the repair or replacement of parts, which prove defective under normal use and service and which Vendor shall determine in its reasonable discretion upon examination to be defective. Before returning any parts, you should contact Vendor’s Customer Service Department using the contact information listed below. If Vendor confirms, after examination, a defect covered by this Limited Warranty in any returned part, and if Vendor approves the claim, Vendor will replace such defective part without charge. If you return defective parts, transportation charges must be prepaid by you. Vendor will return replacement parts to the original retail purchaser, freight or postage prepaid.

This Limited Warranty does not cover any failures or operating difficulties due to accident, abuse, misuse, alteration, misapplication, improper installation or improper maintenance or service by you or any third party, or failure to perform normal and routine maintenance on the product as set out in this owner’s manual. In addition, the Limited Warranty does not cover damage to the finish, such as scratches, dents, discoloration, rust or other weather damage, after purchase.

This Limited Warranty is in lieu of all other express warranties. Vendor disclaims all warranties for products that are purchased from sellers other than authorized retailers or distributors, including the warranty of merchantability or the warranty of fitness for a particular purpose. VENDOR ALSO DISCLAIMS ANY AND ALL IMPLIED WARRANTIES, INCLUDING WITHOUT LIMITATION THE IMPLIED WARRANTIES OF MERCHANTABILITY AND FITNESS FOR A PARTICULAR PURPOSE. VENDOR SHALL HAVE NO LIABILITY TO PURCHASER OR ANY THIRD PARTY FOR ANY SPECIAL, INDIRECT, PUNITIVE, INCIDENTAL, OR CONSEQUENTIAL DAMAGES. Vendor further disclaims any implied or express warranty of, and assumes no responsibility for, defects in workmanship caused by third parties.

This Limited Warranty gives the purchaser specific legal rights; a purchaser may have other rights depending upon where he or she lives. Some jurisdictions do not allow the exclusion or limitation of special, incidental or consequential damages, or limitations on how long a warranty lasts, so the above exclusion and limitations may not apply to everyone.

Vendor does not authorize any person or company to assume for it any other obligation or liability in connection with the sale, installation, use, removal, return, or replacement of its equipment, and no such representations are binding on Vendor.

Blue Rhino Global Sourcing, Inc  
Winston-Salem, North Carolina 27105 USA  
1.800.762.1142

## Troubleshooting

Problem	Possible Cause	Prevention/Cure
<b>Burner will not light using ignitor</b>	LP gas tank valve is closed	Make sure regulator is securely attached to the LP gas tank, turn LP gas tank valve to "OPEN"
	LP gas tank is low or empty	Replace or refill LP gas tank
	LP gas leak	1. Turn LP gas tank valve to "CLOSED" 2. Wait 5 minutes for gas to clear 3. Follow "Checking for Leaks" in the owner's manual
	Battery needs to be changed	Replace the "AA" battery (follow assembly step for inserting battery)
	Electrode and burners are wet	Wipe dry with cloth
	Electrode cracked or broken - sparks at crack	Replace electrode
	Wire loose or disconnected	Reconnect wire or replace electrode/wire assembly
	Wire is shorting (sparking) between ignitor and electrode	Replace ignitor wire/electrode assembly
<b>Burner will not light with match</b>	Bad ignitor	Replace ignitor
	No gas flow	Check if LP gas tank is empty A. If empty, replace or refill B. If LP gas tank is not empty, refer to "Sudden drop in gas flow or reduced flame height"
	LP gas tank is low or empty	Replace or refill LP gas tank
	LP gas leak	1. Turn LP gas tank valve to "CLOSED" 2. Wait 5 minutes for gas to clear 3. Follow "Checking for Leaks" in the owner's manual
	Coupling nut and regulator not fully connected	Turning the coupling nut about one-half to three quarters additional turn until solid stop. <b>Tighten by hand only-do not use tools.</b>
	Obstruction of gas flow	1. Clear burner tubes 2. Check for bent or kinked hose
	Disengagement of burner to valve	Reengage burner and valve
	Spider webs or insect nest in venturi	Clean venturi and burner tube
<b>Sudden drop in gas flow or reduced flame height</b>	Burner ports clogged or blocked	Clean burner ports
	Out of gas	Replace or refill LP gas tank
<b>Irregular flame pattern, flame does not run the full length of burner</b>	Excess flow; safety device may have been activated	1. Turn control knob to "OFF 🔥" 2. Wait 30 seconds and light outdoor fireplace. 3. If flames are still too low, reset the excessive flow safety device: a. Turn control knob(s) "OFF 🔥" b. Turn LP gas tank valve to "CLOSED" c. Disconnect regulator d. Turn control knob to 🔥 (HIGH) e. Wait 1 minute f. Turn control knob to "OFF 🔥" g. Reconnect regulator and leak check connections. h. Slowly turn LP gas tank valve to "OPEN" i. Wait 30 seconds and then light outdoor fireplace per "Lighting Instructions"
	Burner ports are clogged or blocked	Clean burner ports
<b>Flame is yellow or orange</b>	New burner may have residual manufacturing oils.	Burn outdoor fireplace for 15 minutes and reinspect
	Spider webs or insect nest in venturi	Clean venturi
	Poor alignment of valve to burner venturi	Assure burner venturi is properly engaged with valve
<b>Flame blow out</b>	High or gusting winds	Do not use outdoor fireplace in high winds
	Low on LP gas	Replace or refill LP gas tank
	Excess flow valve tripped	Refer to "Sudden drop in gas flow or reduced flame height"
<b>Flashback (fire in burner tube(s))</b>	Burner and/or burner tubes are blocked	Clean burner and/or burner tubes
<b>Flame seems to lose heat when burning in cold weather - temperature below 50°F</b>	Ice has built up on the outside of the LP gas tank because the vaporization process is too slow.	1. Turn LP gas tank valve to "CLOSED" 2. Turn control knob to "OFF 🔥" 3. Replace with a spare LP gas tank 4. Reconnect LP gas tank per "Installing LP Gas Tank" 5. Leak check the connections 6. Light per "Lighting Instructions"

For more assistance please visit us online at [www.bluerhino.com](http://www.bluerhino.com) or call 1.800.762.1142.

