

TOURNEY™

foosball table
mesa de fútbol



WARNING!
ADULT ASSEMBLY REQUIRED.



MODEL # / No.de Modelo
#390008

Assembly, Instructions and Rules

Instrucciones de ensamblaje y reglas

630 Mondial Parkway / Streetaboro Ohio 44060 / 1-877-998-0908

Congratulations!

We hope you will have many hours of enjoyable use with your new AHB Foosball Table!

**PLEASE KEEP YOUR INSTRUCTIONS!**

- Your Model number is necessary should you need to contact us.
- Please read through this instruction book to familiarize yourself with all the parts and assembly steps.
- Refer to the Parts Identifier and verify that all parts have been included.
- For questions that may arise or for missing parts,

DO NOT RETURN THE GAME TO THE STORE.

¡Felicitaciones!

¡Nosotros esperamos que este nueva mesa de fútbol AHB le proporcione muchas horas de diversión!

**¡POR FAVOR GUARDE ESTAS INSTRUCCIONES!**

- Su número de modelo es necesario en caso de que deba comunicarse con nosotros.
- Por favor leer este manual de instrucciones para familiarizarse con todas las piezas y los pasos a seguir en el montaje.
- Consultar la lista Identificación de las Piezas y asegúrese de que todas las piezas hayan sido incluidas.
- Para preguntas o para piezas que no se hayan incluidos,

NO REGRESE EL JUEGO A LA TIENDA

**CONTACT INFORMATION:**

Hours: Mon.-Fri., 8:00am to 5:00pm EST

Replacement Parts: Call (877) 998-0908 or Email

Customerservice@AHBilliards.com

Technical Support: (877) 998-0908 or Email

Customerservice@AHBilliards.com

**INFORMACIÓN DE CONTACTO:**

Horas: lunes a viernes, 8:00am a 5:00pm EST

Piezas de recambio: Llame a (877) 998-0908 o Escribanos

Customerservice@AHBilliards.com

Soporte técnico: (877) 998-0908 o Escribanos

Customerservice@AHBilliards.com

**WARNING!**

This is not a child's toy. Adult supervision is required for children playing this game. Please read instructions carefully. Proper use of this set can avoid damage or injury.

**¡ADVERTENCIA!**

Esto no es un juguete de niños. La supervisión adulta es requerida para jugar este juego por los niños. Por favor leer las instrucciones con cuidado. El empleo apropiado de este juego puede evitar el daño o la herida.

**BEFORE ASSEMBLY:**

- Did you receive 1 box?
- Did you inspect your playfield/main table frame before assembly? It is not replaceable and must be returned to the original place of purchase if damaged.

**ANTES DE ASAMBLAR:**

- ¿Recibió usted 1 caja?
- ¿Inspeccionó usted su campo de juego/marco de mesa antes de la asamblea? No es reemplazable y debe ser devuelto al lugar original de compra.

**TOOLS REQUIRED FOR ASSEMBLY:**

- Phillips and Slotted Head Screwdrivers / or Power Driver (not included)
- Allen Wrench (included)

**HERRAMIENTAS NECESARIAS PARA MONTAR:**

- Destornilladores Phillips y de cabeza ranurada / o destornillador eléctrico (no incluido)
- Llave hexagonal (incluida)

ASSEMBLY INSTRUCTIONS:

We recommend that two adults work together to assemble this table.











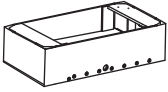

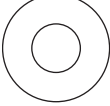

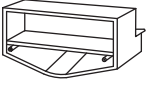
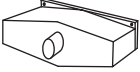

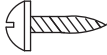
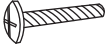

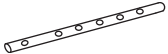
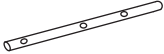
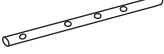
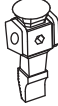

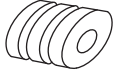

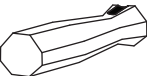
- The table will be assembled upside down This is a very heavy table and turning it right side up it will require at least two strong adults.
- We suggest that you use the bottom carton as a clean flat work area to protect the top of your foosball table while assembling.

INSTRUCCIONES DE ENSAMBLE

Nosotros recomendamos que dos adultos trabajen juntos para ensamblar esta mesa.

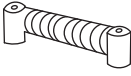
- La mesa debe ser ensamblada de cabeza. Esta es una mesa muy pesada y el voltearla va a requerir al menos dos personas adultas.
- Nosotros sugerimos que utilice el cartón de la base como un área plana de trabajo para proteger la superficie del fulbito de mano cuando es ensamblado.

Parts List

| | | | | | |
|--------------------------------------------------------------------------------------------------------------------------------------|--------------------------------------------------------------------------------------------------------------------------------------|--------------------------------------------------------------------------------------------------------------------------------------|--------------------------------------------------------------------------------------------------------------------------------------------------------|---------------------------------------------------------------------------------------------------------------------------------------------|-----------------------------------------------------------------------------------------------------------------------------------|
| <p>#1</p>  <p>Main Cabinet 1 Piece</p> | <p>#2</p>  <p>Leg 4 Pieces</p> | <p>#3</p>  <p>Lock Nut 10mm 8 Pieces</p> | <p>#4</p>  <p>Washer 10X25mm 8 Pieces</p> | <p>#5</p>  <p>Leg Leveler 4 Pieces</p> | <p>#6</p>  <p>Plastic Goal 2 Pieces</p> |
| <p>#7</p>  <p>Plastic Ball Catcher 2 Pieces</p> | <p>#8</p>  <p>Ball Runner 2 Pieces</p> | <p>#9</p>  <p>T4*12mm Screw 12 Pieces</p> | <p>#10</p>  <p>Bolt 4X28mm 26 Pieces</p> | <p>#11</p>  <p>Lock Nut 4mm 26 Pieces</p> | <p>#12</p>  <p>Ball Entry Cup 2 Pieces</p> |
| <p>#13</p>  <p>5 Player Rod 15.8mm 2 Pieces</p> | <p>#14</p>  <p>2 Player Rod 15.8mm 2 Pieces</p> | <p>#15</p>  <p>3 Player Rod 15.8mm 4 Pieces</p> | <p>#16</p>  <p>Black Player 13 Pieces</p> | <p>#17</p>  <p>Yellow Player 13 Pieces</p> | <p>#18</p>  <p>Bumper 16 Pieces</p> |
| <p>#19</p>  <p>Plastic Washer 16 Pieces</p> | <p>#20</p>  <p>Rod End Cap 8 Pieces</p> | <p>#21</p>  <p>Handle 8 Pieces</p> | <p>#22</p>  <p>Bolt 5X15mm 8 Pieces</p> | <p>#23</p>  <p>5/8" Phillips Head Screw 6 Pieces</p> | <p>#24</p>  <p>Left end Ramp 2 Pieces</p> |
| <p>#25</p>  <p>Right end Ramp 2 Pieces</p> | <p>#26</p>  <p>Side Ramp 2 Pieces</p> | <p>#27</p>  <p>Slide Scorer 2 Pieces</p> | <p>#28</p>  <p>Flat Countersunk Screw 4X44.5mm 4 Pieces</p> | <p>#29</p>  <p>Soccer Ball 4 Pieces</p> | <p>#30</p>  <p>Wrench 1 Piece</p> |

STEP: 1

- Attach Legs (part #2) to Main Cabinet (#1) using 10x25mm Washer (#4) and 10mm Lock Nut (#3).
- Leg Levelers (#5) into Legs.

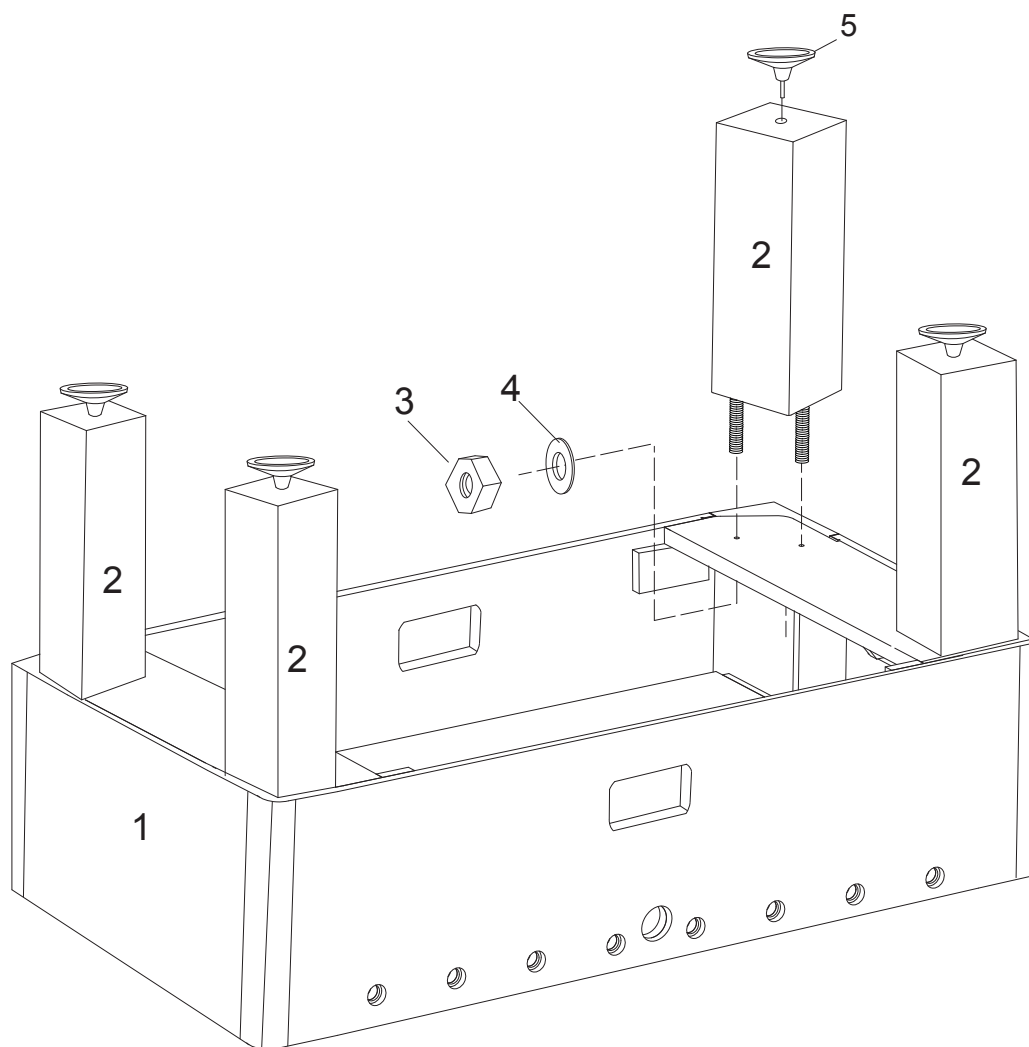

STEP:2

- Attach Plastic Ball Catcher (#7) to Main Cabinet using T4x12 mm Screws (#9).
- Attach Ball Runner (#8) to Plastic Ball Catcher and Plastic Goal (#6).
- Attach Plastic Goal to Main Cabinet using T4x12 mm Screws.

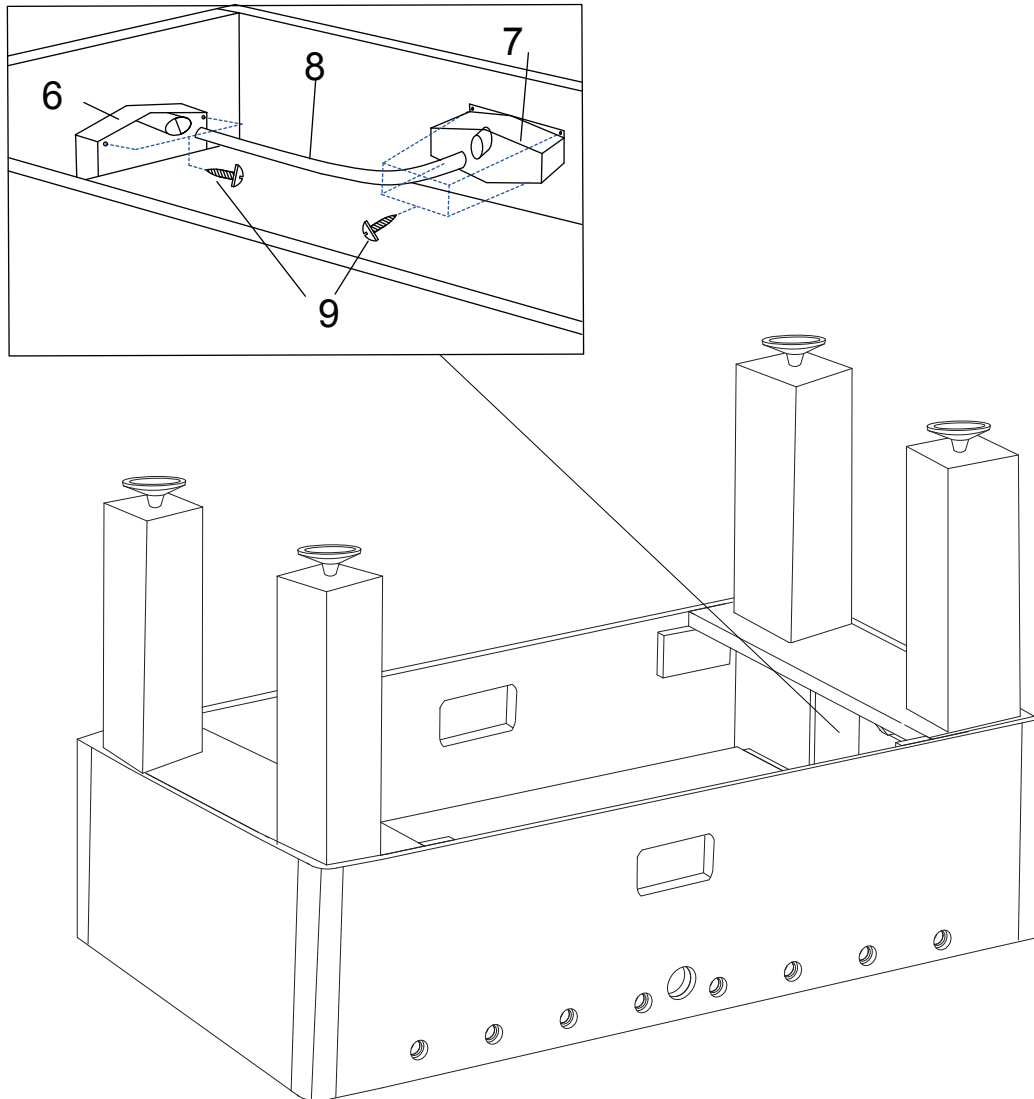

STEP:3

- Arrange the Ramps as shown, then remove backing to reveal the adhesive and apply.
- Note: Left and Right is determined by facing the narrow end of the table, and is applicable to the end at which you are standing.

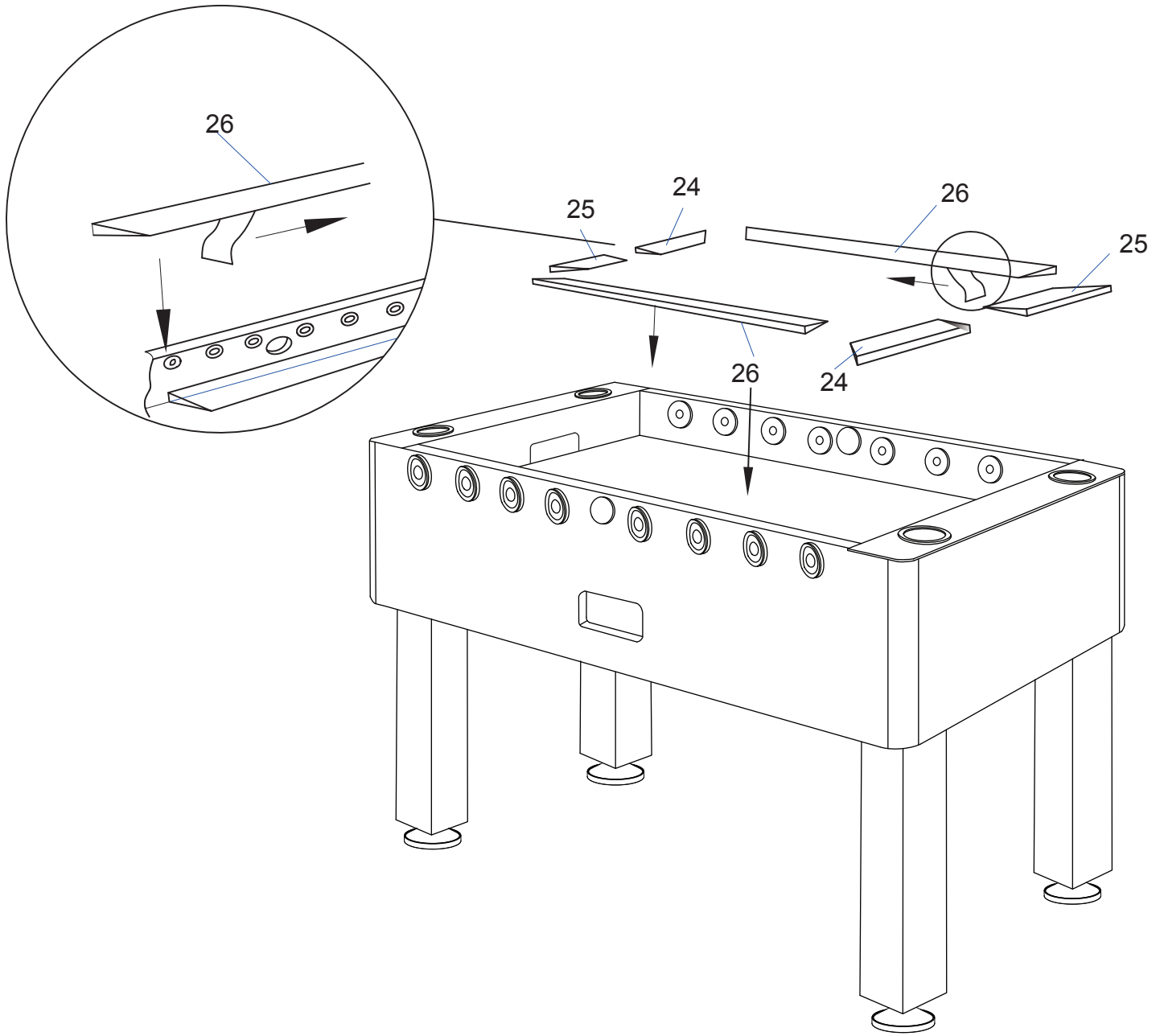

STEP:4

- Thread the players onto rods as shown.
- Affix players to the rod with 4x28 mm Bolts (#10) and 4mm Lock Nuts (#11).
- At the handle end of the rod, thread on a Plastic Washer (#19), Bumper (#18), then Handle (#21). Attach handle with a 5x15mm Bolt (#22).

