



Manual SRM Series

Manual Pull-Down Projection Screen

USER'S GUIDE



Pre-installation

1. Carefully unpack the screen.
2. Always handle the screen in a leveled position on a clean surface.

INSTALLATION

Flush Wall Mounting

1. Mark the location of where the screen is to be installed for the pre-drilled hole.
2. After marking the area and drilling the hole, insert the proper screw into the drilled hole and leave about 1/8" of an inch from the wall to mount the screen.
3. Mount your screen from the keyhole located on back of screen's left and right end cap.

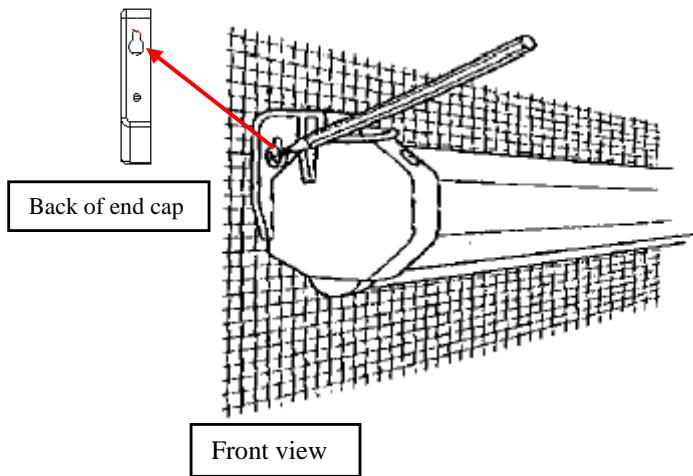

Ceiling Mounting (additional hardware required)

Optional installation using a chain to hang the screen from the ceiling.

1. You can also hang the screen on a ceiling by using a chain (not included) and hang it by the two loops located on each end of the case.

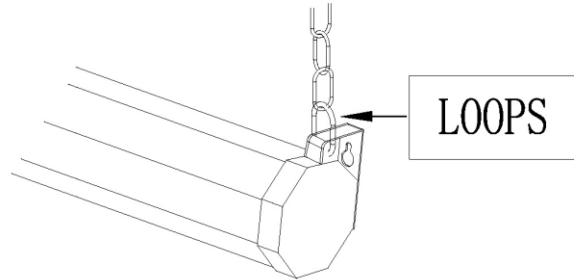
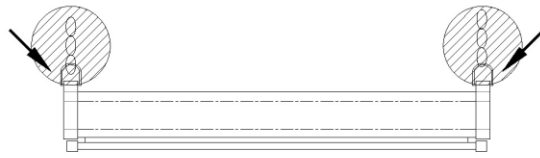

SCREEN OPERATION

*Note: **Always** pull the screen down or let it up in a 90-degree vertical angle. Do not allow the screen to touch the screen case when the screen goes up or comes down to avoid damaging the screen material.*

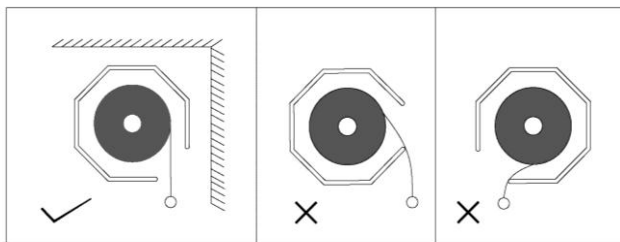

1. Pull the screen down from the lanyard or from the handle only in a 90-degree angle. Do not attempt to pull the screen down by the surface or touch the screen, as it will damage the screen and void the warranty.

Note: An internal auto-lock mechanism system will cause the screen to stop and lock on the position at intervals.

2. If you want the screen to retract back, simply pull the screen down more than 2 inches and retract the screen back by quickly and smoothly releasing it up gently. The screen is equipped with a **SLOW RETRACT MECHANISM (SRM)** which allows the screen to slowly retract without the need to hold on to the handle or lanyard. Simply release the handle and the screen will retract by itself.

Note: Always release at a 90-degree angle and do not let go until the screen is entirely inside the case
If ever the screen feels stuck, keep in mind that the screen's mechanism is new and needs to be run up/down a few times to loosen up. If this happens, carefully with a little force yank the screen straight down to unlock the screen.

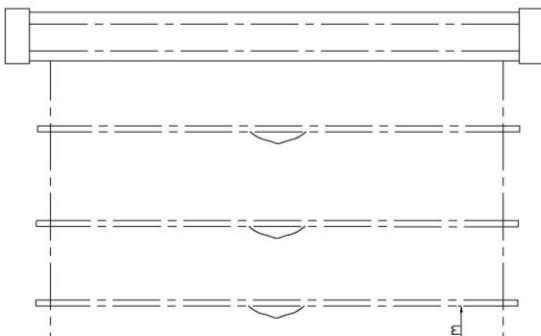

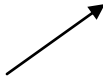

Note: Improperly bringing the screen up/down will damage the screen material or rolling system.

MAINTENANCE

Clean matte white screen material with a soft cloth and mild soap with water.
When not in use, retract screen in its housing to keep the screen material surface clean.

NOTE:

Regardless of mounting method, the screen should be securely supported so that vibration or even abusive pulling on the viewing surface will not cause the case to work loose or fall. The installer must insure that the fasteners used are of adequate strength and suitable for the mounting surface chosen.

Manual SRM Series Dimensions Table

Unit: mm													
Models	Diagonal Size/Aspect Ratio	Case Length (A)	Screen Width (A1)	View Width (A2)	Weight Bar Length (A3)	Bottom Edge Distance (B4)	Screen Material to Weight Bar Height (B3)	View Height (B1)	Overall Height (B)	End cap Height (B5)	End cap Width (C)	Screen material distance to wall (C1)	N.W. (KGS)
M85XWS1-SRM	85" (1:1)	1677	1603	1527	1673	62	1703	1527	1795	92	79.5	20	6.0
M99NWS1-SRM	99" (1:1)	1938	1854	1778	1934	62	1954	1778	2046	92	79.5	20	8.0
M113NWS1-SRM	113" (1:1)	2192	2106	2030	2188	62	2206	2030	2298	92	79.5	20	9.2
M84NWV-SRM	84" (4:3)	1867	1783	1707	1863	62	1456	1280	1548	92	79.5	20	6.2
M100NWV1-SRM	100" (4:3)	2192	2108	2032	2188	62	1700	1524	1792	92	79.5	20	8.0
M120XWV2-SRM	120" (4:3)	2598	2514	2438	2594	62	2005	1829	2097	92	79.5	20	10.4
Unit: inch.													
Models	Diagonal Size/Aspect Ratio	Case Length (A)	Screen Width (A1)	View Width (A2)	Weight Bar Length (A3)	Bottom Edge Distance (B4)	Screen Material to Weight Bar Height (B3)	View Height (B1)	Overall Height (B)	End cap Height (B5)	End cap Width (C)	Screen material distance to wall (C1)	N.W. (LBS)
M85XWS1-SRM	85" (1:1)	66.0	63.1	60.1	65.9	2.4	67.0	60.1	70.7	3.6	3.1	0.8	13.2
M99NWS1-SRM	99" (1:1)	76.3	73.0	70.0	76.1	2.4	76.9	70.0	80.6	3.6	3.1	0.8	17.6
M113NWS1-SRM	113" (1:1)	86.3	82.9	79.9	86.1	2.4	86.9	79.9	90.5	3.6	3.1	0.8	20.2
M84NWV-SRM	84" (4:3)	73.5	70.2	67.2	73.3	2.4	57.3	50.4	60.9	3.6	3.1	0.8	13.6
M100NWV1-SRM	100" (4:3)	86.3	83.0	80.0	86.1	2.4	66.9	60.0	70.6	3.6	3.1	0.8	17.6
M120XWV2-SRM	120" (4:3)	102.3	99.0	96.0	102.1	2.4	78.9	72.0	82.6	3.6	3.1	0.8	22.9

*Measurement dimensions are intended as a reference only and subject to change without notice. Note: Data Error ± 1 "

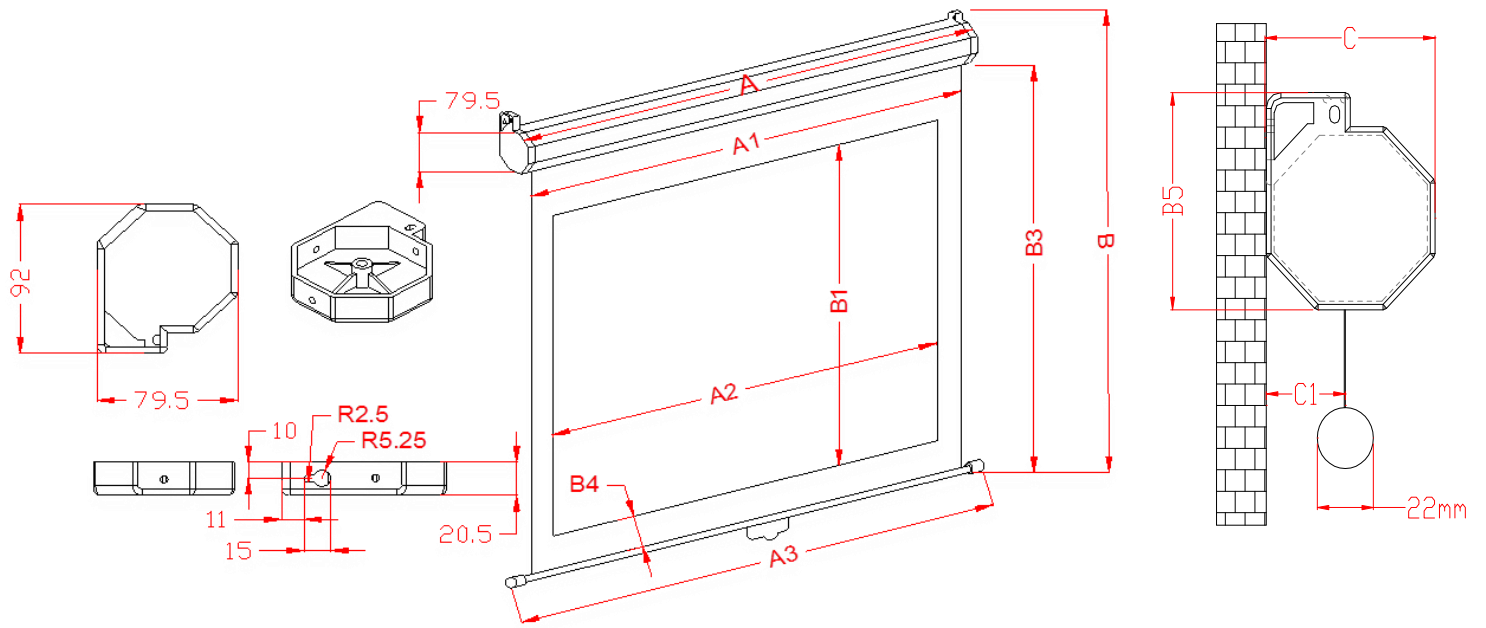

Warranty Policy

- Two (2) year warranty parts and labor from defects in workmanship from purchase date as follows.
- Three (3) year warranty parts and labor for GEMR (Government, Education, Military, and Religious purchases)
- Each party will be responsible for one way shipping during the warranty period. Elite Screens is not responsible for applicable International tariffs such as broker fees and customs duties.
- **A RMA (Return Merchandise Authorization) number** must be issued in order to process a replacement or to authorize a return for warranty repair. Elite Screens will, at its sole option, replace or repair the defective unit with a replacement *(see exceptions below) after the defective unit is received. Once the product is received, Elite Screens will send out a replacement *unit to the customer by ground service (subject to inventory availability). **Please do not return any unauthorized items to Elite Screen, as they will be refused. The RMA number must be included on the outside label of your shipping box. Our warehouse is not authorized to accept returns without an RMA number on the shipping label. RMA numbers are valid for 45 days from the date of issue.**
- **Missing Parts** must be reported within the 7-day grace period. If reported after 7 days, customer will be only be responsible for shipping and handling fees. If reported after 30 days of receipt, customer is responsible for cost of the parts and shipping & handling fees.

*A new or refurbished replacement will be sent out to the customer depending on the type of purchase (new or refurbished) or based on stock availability.

Please visit link below for full warranty information

North America (USA and Canada) only

For Customer Service and Technical questions, please contact Elite Screens at:

Telephone: 562-483-8198

Fax: 562-483-8498

For Warranty and Service requests please fill out a RMA /Service Form at:

http://www.elitescreens.com/service_form.htm.

Please Visit this link for full Warranty information:

<http://www.elitescreens.com/service.htm>

PRODUCT REGISTRATION:

WWW.ELITESCREENS.COM/REGISTER.HTM

CONTACT INFO:

US & Canada Tech Support & Warranty Claim

Please contact us at service@elitescreens.com or call +1 877-511-1211 #3 Service

Europe Tech Support & Warranty Claim

Please contact us at service@elitescreens.eu or call +49-(0) 40-30392958

Asia Tech Support & Warranty Claim

Please contact us at service@elitescreens.com.cn or call +86-(0) 755-8461-7989

Taiwan Tech Support & Warranty Claim

Please contact us at service@elitescreens.com.tw or call +886-(02) 2747-8979

America:

Elite Screens Inc

16410 Manning Way
Cerritos, CA 90703 USA
Tel: +1-562-483-8198 (877-511-1211)
Fax: +1-562-483-8498
info@elitescreens.com
www.elitescreens.com

Asia:

Elite Screens China Corp.

Longxi Duimianling Industry Zone Longcheng
Longgang District,
ShenZhen GuangDong, China
Tel: +86-(0)755-8461-7989
Fax: +86-(0)755-8461-7669
info@elitescreens.com.cn
www.elitescreens.com.cn

Taiwan:

Elite Screens Taiwan Co. Ltd.

No.38, Alley 22, Lane 66, Sec. 5, Nanjing E. Rd.,
Songshan District, Taipei City 105, Taiwan
Tel: +886-(02)2747-8979
Fax: +886-(02)2747-8978
info@elitescreens.com.tw
www.elitescreens.com.tw

Europe:

Elite Screens Europe GmbH

Elite Screens Europe GmbH
Lübecker Straße 1
22087 Hamburg, Germany
Tel: +49-40-30392494
Fax: +49-40-49219200
info@elitescreens.eu
www.elitescreens.eu

Elite Screens France

11, Allée William Penn
92150 Suresnes, France
pascale.dautemer@elitescreens.com
www.elitescreens.com/fr

India

Elite Screens India

Delhi, India
Tel: +91-22 98191257839
Fax: +91-22 22150373
info.india@elitescreens.com
www.elitescreens.com.in

Latin America Contact:

erik.garcia@elitescreens.com

East Asia Contact:

info.ea@elitescreens.com

Japan Contact:

info.japan@elitescreens.com