



PLEASE READ BELOW BEFORE PROCEEDING WITH YOUR ASSEMBLY

Unless you're particularly adept at assembling Flatpack/Knockdown Furniture, we understand building ready to assemble furniture can be a frustrating experience for some and you'll probably spend at least half a day per item. No need to panic, though! Here are some tips on assembling flat-pack furniture so you're not left with an impossible Lego project and give up in frustration. Follow these tips for your item and you'll end up with beautiful, fully-assembled furniture!

- Do Not throw away packaging material until assembly is complete.
- Assemble item on a soft surface, such as cardboard or carpet, to protect finish.

- Choose a spacious, open area near where the piece will be located. It is easier to move parts than to relocate the furniture after it is fully assembled, depending on its size and weight.
- Organize everything and count it twice. If you organize the items by parts, you'll find it much easier to grab each piece as you build.
- Check each one for cracks or flaws, such as improperly drilled holes, and count multiple parts. If there are any problems or missing pieces, contact the manufacturer with the part number, model number of the finished piece, and a description of the problem to arrange a replacement.
- It is best to use any tools the kit provides, such as a hex key, because they may be specially sized for that piece of furniture. But when in need, a Phillips-head screwdriver & Power Drill are highly suggested for large projects.
- Read the entire list of instructions, arranging your parts in order of use as you go.
- Finally, Enlist a help from friends and family since proper assembly of most items require 2 people.

ASSEMBLY INSTRUCTION

PLEASE READ BEFORE ASSEMBLING!

Tip #1: Make sure you've taken all the pieces and hardware out of its packaging before discarding the box.

Tip #2: Using page 2 and/or page 3 of instruction manual make sure all pieces and hardware are accounted for.

Tip #3: Read manual before assembling, it helps!

ITEM#: 11416CT

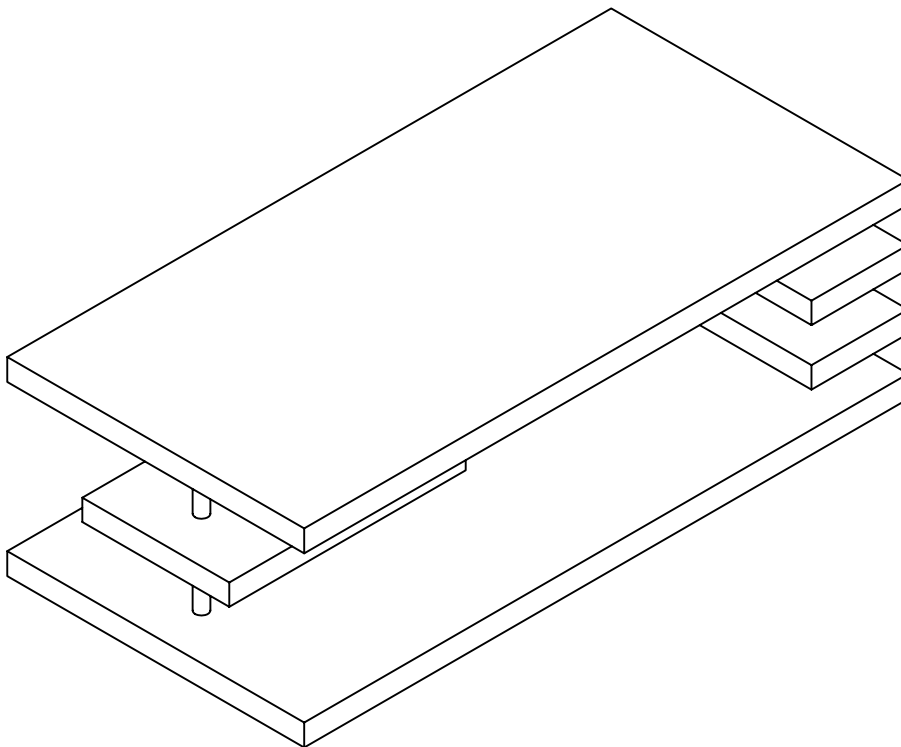

PARTS IDENTIFICATION



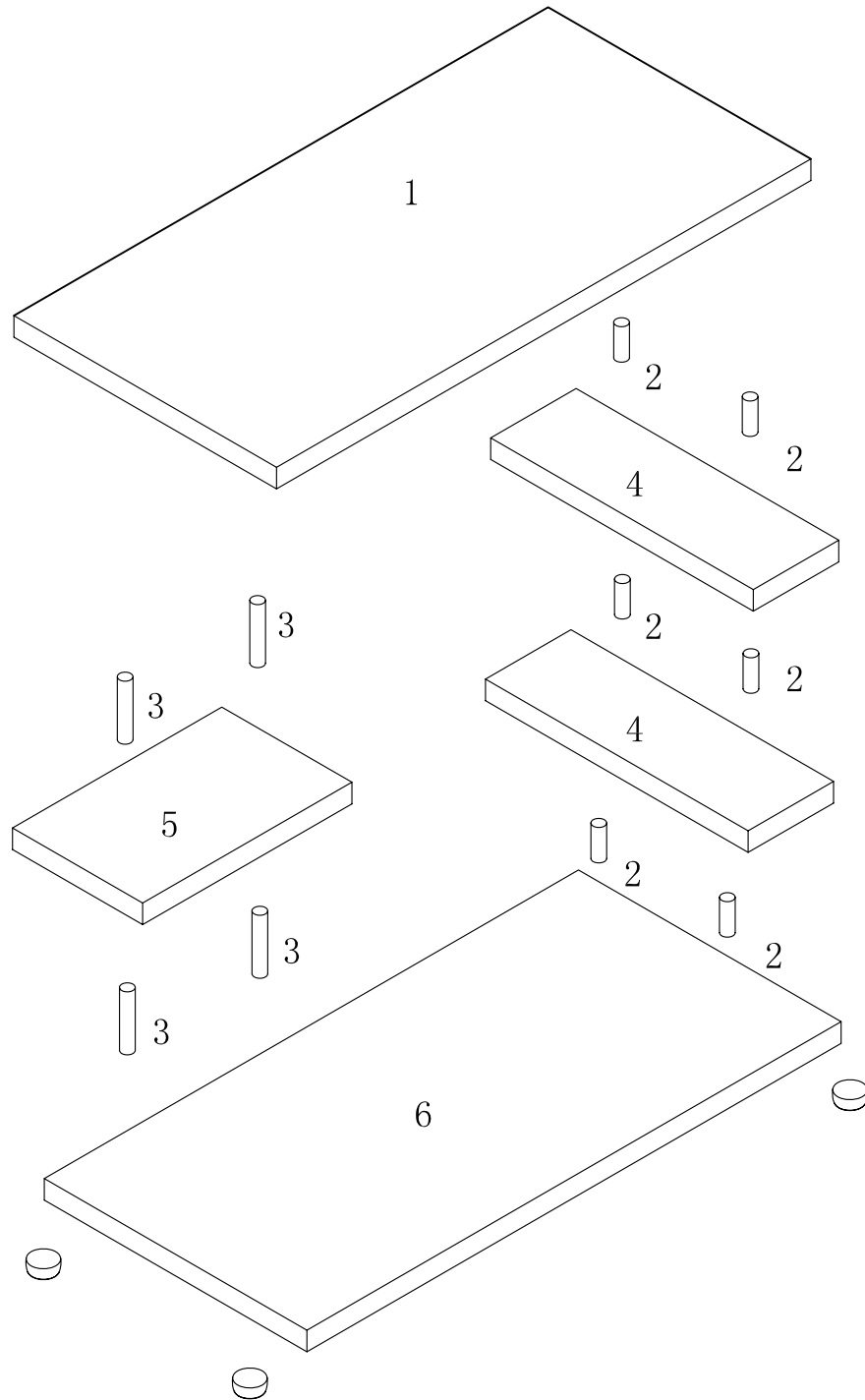







ITEM#: 11416CT



(1)	1pc	(6)	1pc
(2)	6pcs		
(3)	4pcs		
(4)	2pcs		
(5)	1pc		

HARDWARE IDENTIFICATION

ITEM#: 11416CT

A		M6 × 50	6pcs
B		M4	1pc
D		∅55 × 25	5sets
E		M6 × 25	2pcs
F		M6 × 65	4pcs
G		∅10 × 15	4pcs
H		M6 × 55	4pcs
I		∅4 × 25	16pcs
J		70 × 50 × 2	4pcs
K		Glue: For securing please apply to wood dowel first before inserting into panel	1pc

ASSEMBLY INSTRUCTION

ITEM#: 11416CT

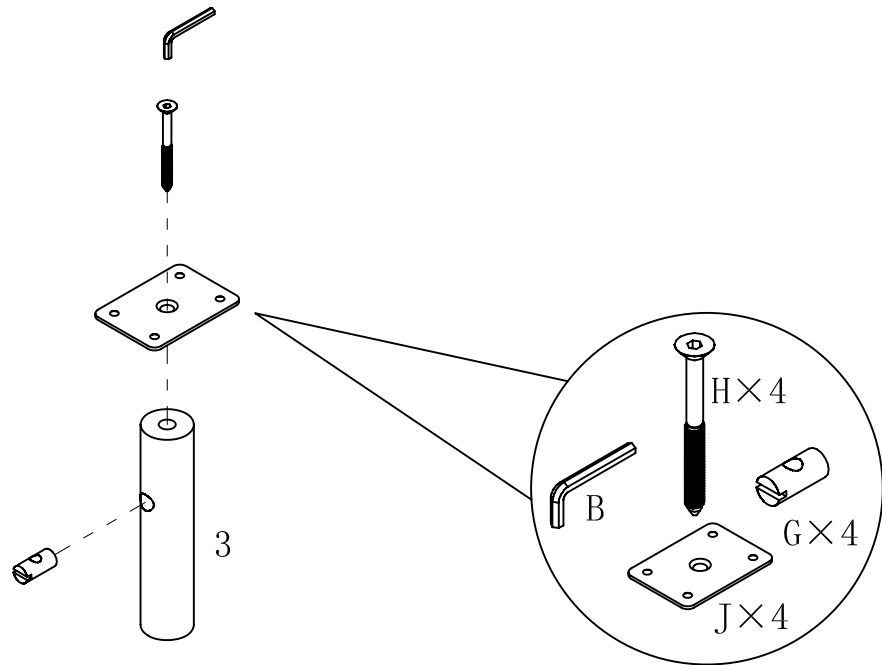

STEP1

STEP2

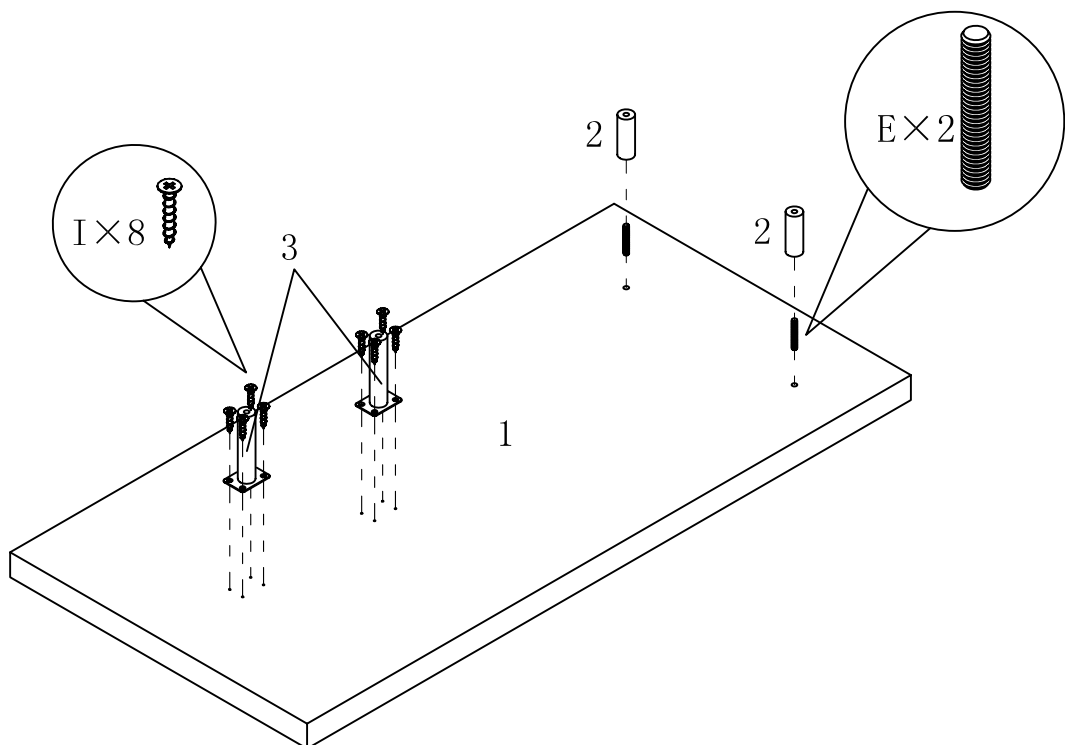

ASSEMBLY INSTRUCTION

ITEM#: 11416CT

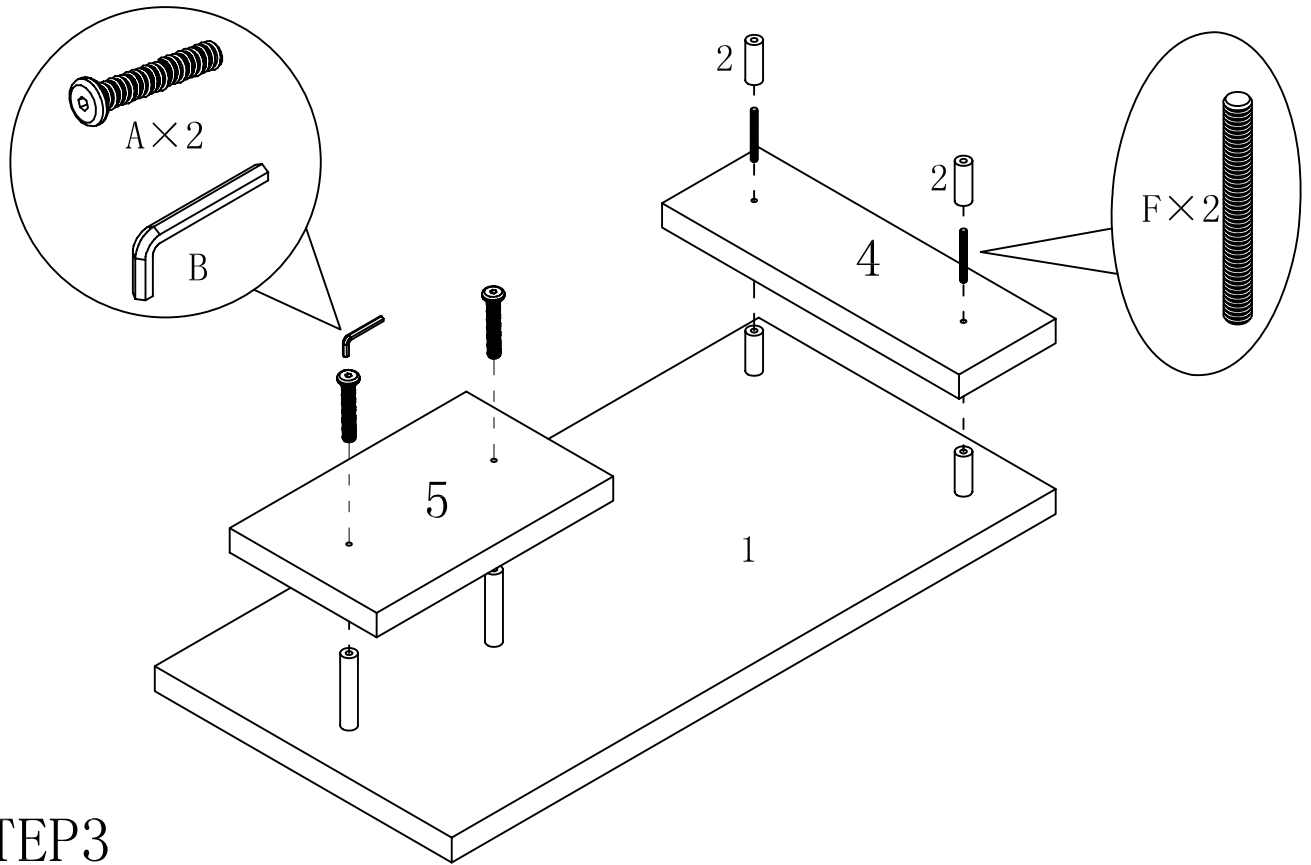

STEP3

STEP4

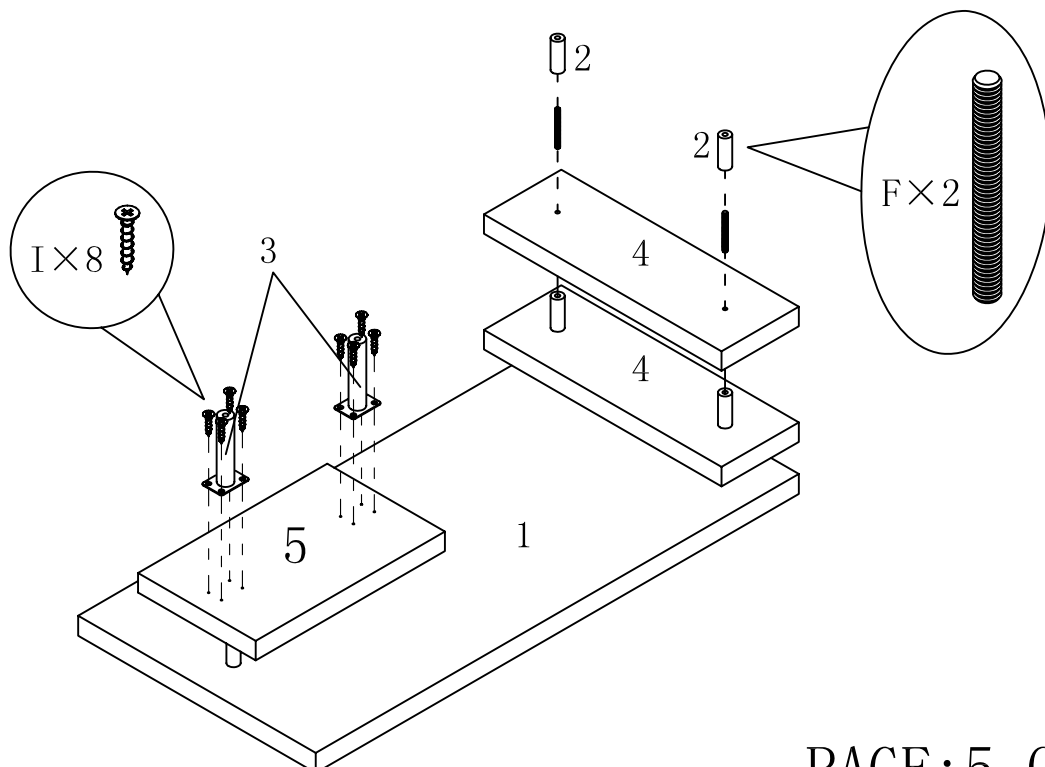

ASSEMBLY INSTRUCTION

ITEM#: 11416CT

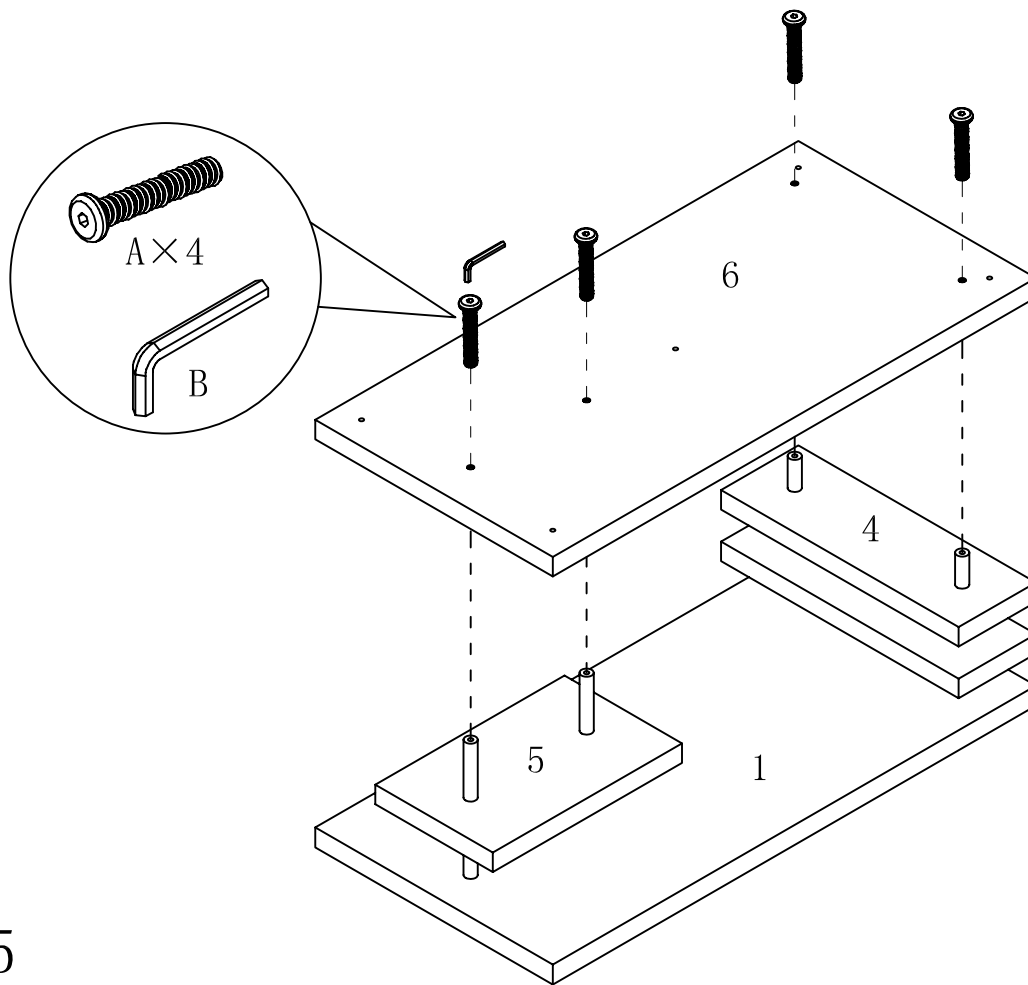

STEP5

STEP6

