

PANDORA

FR42405BRC

Bulbs : 60W CAND.

Replacement Parts: SHADE R42400SH

ASSEMBLY INSTRUCTIONS

Assembly of this fixture will be accomplished by first, determining the length of stems required, attaching the mounting strap to the junction box, making all necessary electrical connections, hanging the fixture from the ceiling, and then installing the shade.

SAFETY WARNING: Read wiring and grounding instructions [FRIS 18] and any additional directions. Turn power supply off during installation. If new wiring is required, consult a qualified electrician or local authorities for code requirements.

STEP 1

- 1 Determine the overall length you will need the assembled fixture to be.
- 2 Determine what stems will be needed to achieve the overall length you require. (Additional stems are available and can be ordered. Ask your local Fredrick Ramond representative or visit www.fredrickramond.com for information).
- 3 Install first stem (b), threaded end first, by slipping it along supply wire and threading it into coupler (A) - see Drawing 1.
- 4 Continue adding stems (C) in this fashion until the desired length is achieved.
- 5 To complete fixture installation, please refer to mounting instruction sheet [IS-19-91] supplied and then refer back to this sheet for instruction on completing the fixture assembly.

STEP 2

- 1 Fixture can be lamped accordingly at this point. It is recommended that flame tip candlelabria bulbs NOT be used, since the flame tip may interfere with the shade setting properly on the fixture - see Drawing 2.
- 2 To attach shade (1) turn shade so inside bulb clip (s) is perpendicular to the outside of the fixture. Spread bulb clip (s) and slip onto bulb. Shade can now be adjusted.

[DRAWING 1]

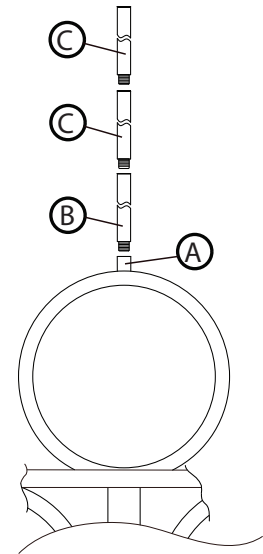

[DRAWING 2]

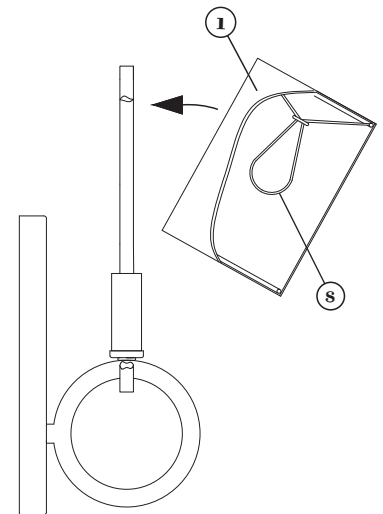

FREDRICK RAMOND
ESTABLISHED 1965