

We would like to take this opportunity to thank you for your purchase of this American Bath Factory Bathtub.  
Should you have any questions or feedback about your new bathtub, please call us toll-free at (800) 454-BATH (Monday thru Friday, 7:15am - 4:00pm PST) or email us at info@americanbathfactory.com



# DUKE/TRINITY

## user guide

### BEFORE YOU BEGIN

To ensure that no damage has occurred to your bathtub during shipping, it is important to check your bathtub for damage prior to installation in your home!

Move your new bathtub to a location that will not be damaged by water run-off. A driveway or patio is suitable for testing your bathtub.

We recommend that you install the waste & overflow onto the bathtub at this time.

This will help with water testing your new bathtub, these parts are highlighted in **Bold Gray Type** (See Fig. 1)

**American Bath Factory recommends having a certified plumbing technician install your bathtub**

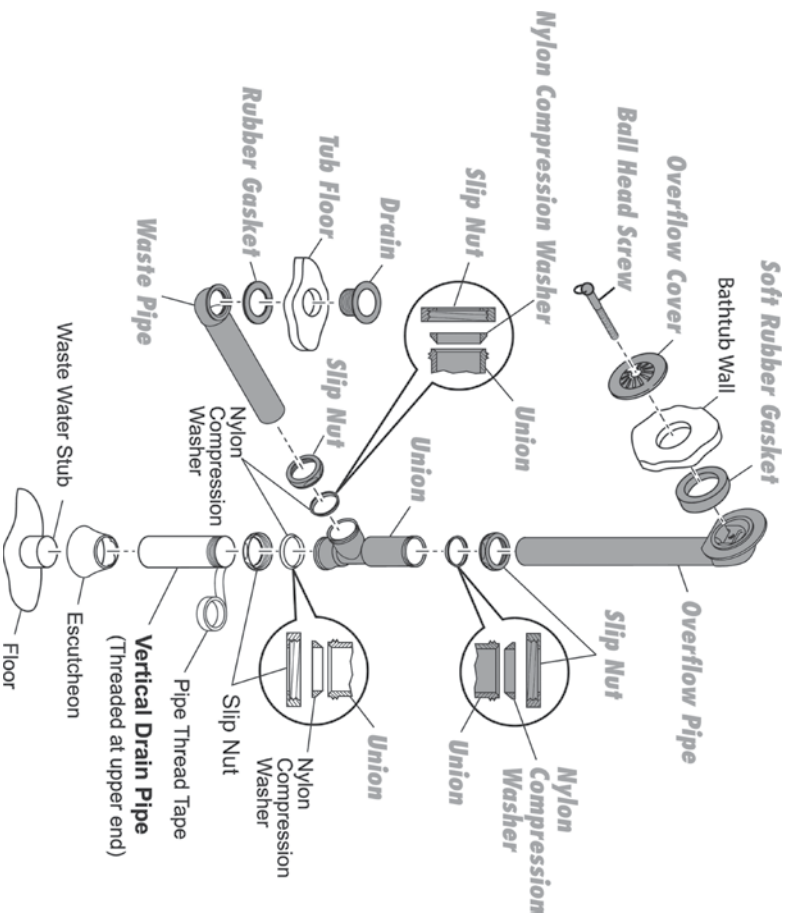

Fig. 1 - Overflow & Drain Assembly

## !! IMPORTANT !!

**Your bathtub is a DOUBLE WALL construction. The drain needs to be installed with**

**SILICONE, not Plumber's Putty!**

Apply a liberal quantity of "kitchen and bath" type silicone (available in most "home" or hardware stores) to the drain threads and a bead on the underside of the Drain Flange (See Fig. 2). Insert the Drain through the drain hole, screw into the Waste Pipe and verify that the rubber gasket is seated properly between the bottom of the tub and the Waste Pipe. The handles of a pair of pliers can help you screw the Drain securely into the Waste Pipe (See Fig. 3). Wipe off any excess silicone around the drain with a clean, dry cloth.

**Allow 24 hours for the Silicone to cure completely before adding water to the bathtub.**

If everything is sealed and dry, fill your bathtub 3/4 of the way and check for leaks. After the water test is complete and there are no leaks, proceed with installing your bathtub.

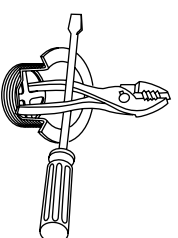

Fig. 3 - To Tighten Drain

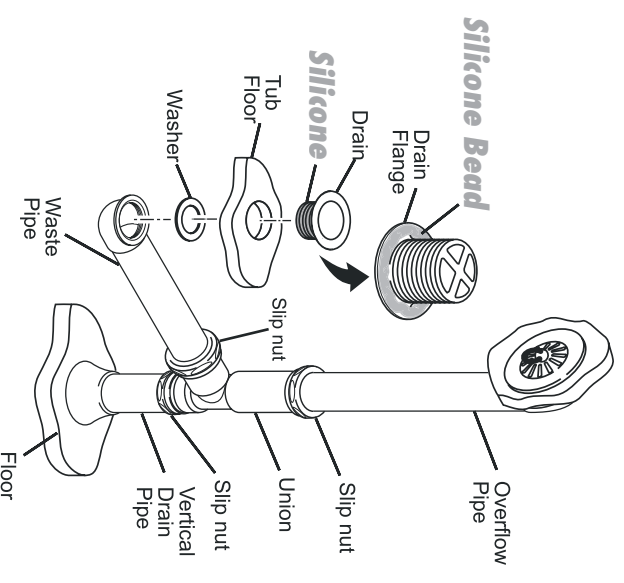
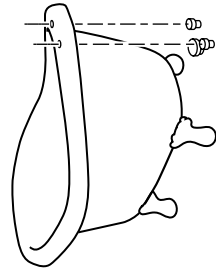

Fig. 2 - Securing Your Drain

## ALIGN & SECURE YOUR BATHTUB

Now that the water test is complete, pay careful attention when transporting your clawfoot bathtub through a narrow doorway. Tilt your bathtub on its nose, on to a soft surface (folded towel, sheet, etc.), and spin it through the doorway. We recommend doing this instead of disassembling the feet.

Carefully align your bathtub over the water supply stubs and drain. For deck or tub mounted bathtubs, it may be helpful to temporarily attach your faucet and water supply lines to the bathtub, to aid in aligning the bathtub directly over the water supply stubs.



Aligning your Bathtub

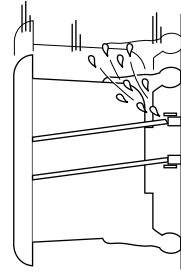

**WARNING - Failure to secure your bathtub may cause leaks if the bathtub is moved.**

### Securing Your Bathtub

#### Failure to secure your bathtub will void your warranties!

It is very important to secure your bathtub to the floor.

This avoids bending or straining the water supply connections and drain, if the bathtub is bumped or moved, possibly causing leaks.

There are several methods for securing your bathtub to the floor depending on the type of flooring the bathtub is sitting on. The simplest methods are to use (A) readily available rubber non-skid furniture pads (secured to the floor with screws or glue) under each foot, or (B) a small amount of glue or epoxy directly on the floor under each foot.

The preferred method (C) (refer to steps 1-3 below) is to fix dowels or pins in the floor for each bathtub foot. Once your bathtub is secured, shim, if necessary, to ensure your bathtub does not rock and your tub is stable and level.

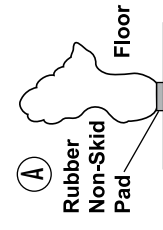

(A) Rubber Non-Skid Pad Floor

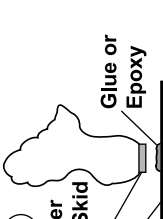

(B) Rubber Non-Skid Pad Floor  
Glue or Epoxy

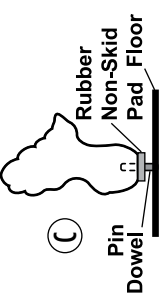

(C) Rubber Non-Skid Pad Floor  
Pin Dowel

#### PREFERRED METHOD

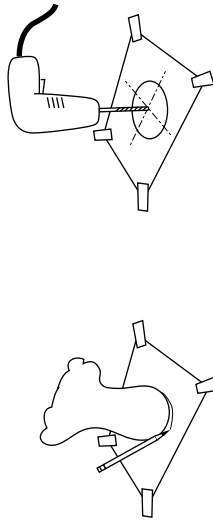

1. Locate your bathtub in its final position. Mark foot locations on a piece of paper taped to the floor.

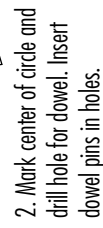

2. Mark center of circle and drill hole for dowel. Insert dowel pins in holes.

3. Carefully lower bathtub over dowel pins.

3

## INSTALLATION SPECIFICATIONS

### Duke/Trinity

Overall Dimensions: 60" L x 30" W x 24" H  
Capacity: 40 Gallons  
Weight Without Champagne: Dry Weight = 140 lbs./ Full Weight = 474 lbs.  
Weight With Champagne: Dry Weight = 150 lbs./ Full Weight = 484 lbs.  
Shaded areas only included on models with Champagne Massage. (See Champagne User Guide for details).  
Dimensions shown have a tolerance of  $\pm 1/2"$ .  
Dimensions shown not to scale.

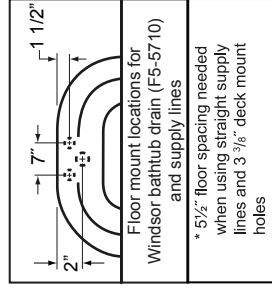
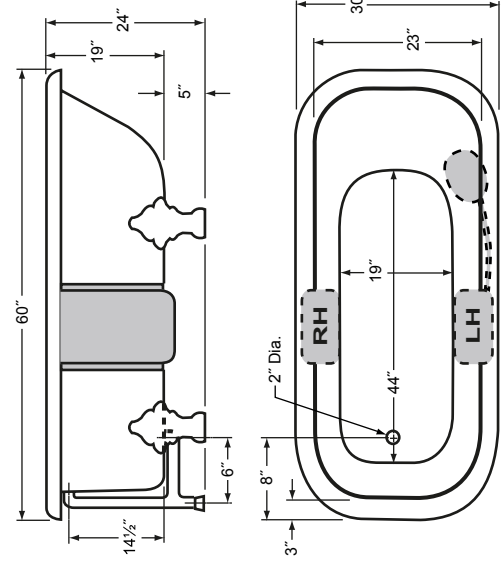

Floor mount locations for Windsor bathtub drain (F5-5710) and supply lines

\* 5/8" floor spacing needed when using straight supply lines and 3/8" deck mount holes

### Water Supply From Floor

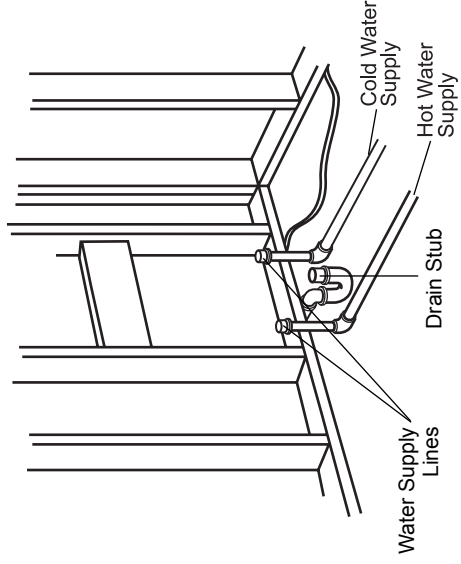

### Deck or Tub Mount

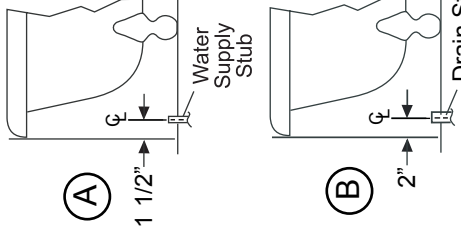

(A) The faucet holes (where the supply lines are placed) are located 1 1/2" in from the edge.

(B) The drain is located 2" inches in from the edge of the bathtub.

Note: For recommended Wall Mount & Floor Mount, installation measurements see attachment. Do not use the measurements for the Deck Mount listed above if you purchased a Wall Mount or Floor Mount.

4

## CLEANING & MAINTAINING YOUR BATHTUB

Your bathtub's surface is very easy to clean. There are no pores for dirt to penetrate, so dirt will just rinse off with water. For sanitary purposes, you should occasionally clean your bathtub with a non-abrasive soap. Dishwashing detergent such as JOY®, PALMOLIVE, IVORY®, etc., is all that is required. If you spill something on the bathtub and need something stronger, the following are SAFE to use: GEL GLOSS®, TACKLE®, TOP JOB®, FORMULA 409®, SCRUBFREE®, CALGON BATH®, WINDEX®, CLOROX BLEACH®, SPIFFITS BATH®, GLASS PLUS® and SPIC & SPAN POWDER®.

## IMPORTANT

**DO NOT CLEAN YOUR BATHTUB WITH PAINT THINNER, GOOF OFF®, SCRUBBING BUBBLES®, ACETONE, LACQUER THINNER, M.E.K.®**

or other chemicals that attack the structural integrity of plastics (including, but not limited to acetones). Use of these chemicals will destroy the acrylic surface of your bathtub

## USE OF THESE CHEMICALS WILL VOID YOUR WARRANTY

If you should dull, scratch, or chip your bathtub, the appearance can be restored back to its new look. Scratches and dulling can be removed with a liquid polisher such as Gel-Gloss®. Deep scratches or burns can be removed by using a very fine sandpaper (600 grit or higher) and then finished with a liquid polish.

## SAFETY INSTRUCTIONS

- **DANGER!** To reduce the risk of injury, do not permit children to use bathtubs unless they are closely supervised by an adult at all times.
- Use this bathtub only for its intended use as described in this manual. Do not use attachments not recommended by the manufacturer.
- Do not attempt to plug in or unplug the electrical devices (including the bathtub) while in or near a filled bathtub. Never use or handle electrical devices while in or near a filled tub.
- Never drop or insert any objects into any openings.
- Only healthy adults should use the bathtub when the water temperature is between 100°F and 104°F (38° - 40°C). Any temperature below 100°F is considered safe for longer durations (exceeding 10 - 15 minutes) or for young children. The water temperature in a bathtub should never exceed 104°F (40°C).
- Excessive water temperatures have a high potential for causing fetal damage during the early months of pregnancy. Pregnant or possibly pregnant women should limit bathtub temperatures to 100°F (38°C).
- The use of alcohol, drugs, or medications before or during bathing may lead to unconsciousness and the possibility of drowning.
- Use of this bathtub may cause drowsiness and changes in heart rate and/or blood pressure. Persons suffering from obesity, who have a medical history of heart disease, low or high blood pressure, circulatory problems, or diabetes should consult a physician before using. Persons using medications should consult a physician before using this bathtub.

Information in this document is subject to change without notice. Copyright 2010, American Bath Factory. All rights reserved. Reproduction in any manner whatsoever without the written permission of American Bath Factory is strictly forbidden. Trademarks and trade names used in this document refer to either the entities claiming the marks and names or their products. American Bath Factory disclaims any proprietary interest in trademarks and trade names other than its own.

5

6