

# **4 DC TWO DOOR TOWER**

**MODEL: 76422**

## **NEED ASSISTANCE ?**

Call 4D CONCEPTS directly for parts or assembly assistance.

Individual stores do not stock parts

Call our Toll-free number 5 days a week except holidays:

Monday through Friday 8.00am to 5.00pm

Pacific Standard Time

**1-888-310-4DCO or 1-888-310 4326**

**IMPORTANT:** Before calling please have the model number  
and the packing code number ready for our customer service representatives.

You will find the model number printed on the carton label and the packing  
code printed in black ink on the side of the carton.

Model                    76422                    Packing code

It is important that you retain the model number and the packing code  
along with the original receipt of purchase for future reference.

Made in China

# 76422 ASSEMBLY INSTRUCTION

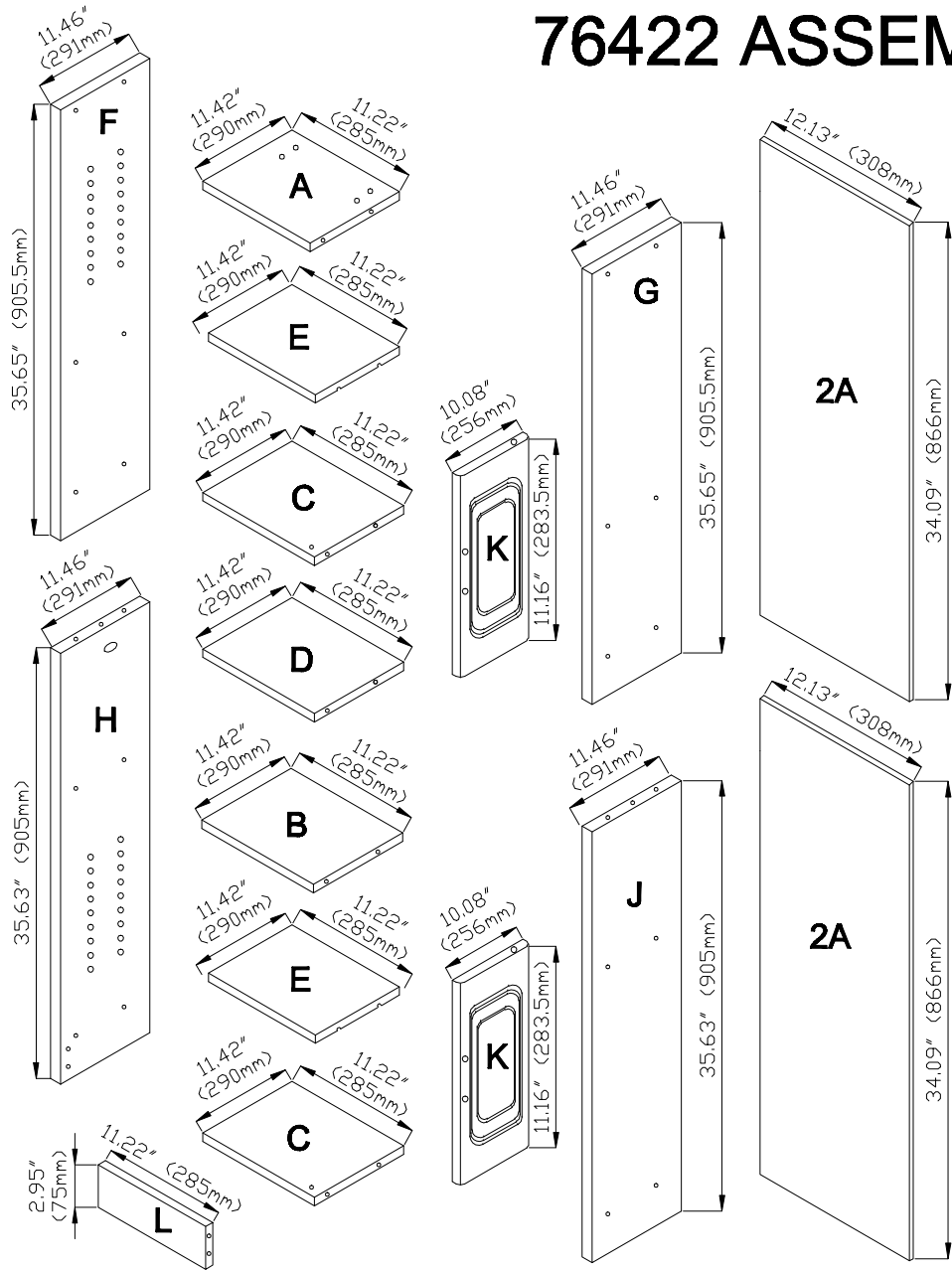

**M X 8**  
6 X 30 mm

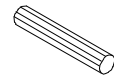

**N X 20**  
8# X 38 mm

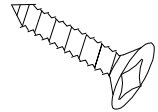

**P X 8**



**Q X 2**

(FIXED DOOR HINGE)



**R X 2**

(SPRUNG DOOR HINGE)



**2S X 4**  
3 X 12 mm



**S X 2**

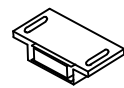

**2T X 2**  
3 X 10 mm



**T X 2**

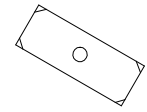

**U X 30**



**V X 4**  
4 X 25 mm

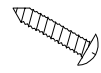

**W X 2**



**Y X 2**

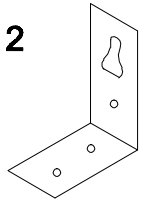

**Z X 4**  
4 X 10 mm



**2M X 2**

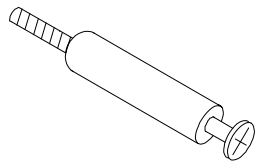

**2N X 2**



**2K X 1**  
GLUE

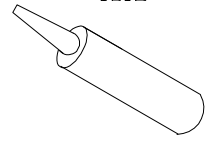

**2P X 4**  
4 X 32 mm

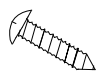

**2Q X 4**

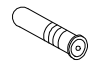

**STEP 1**

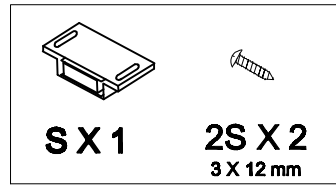
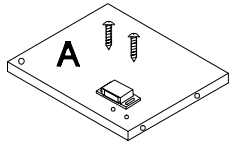

**STEP 2**

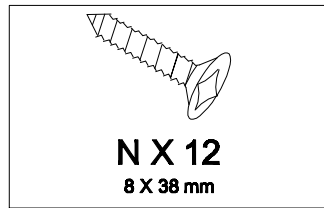
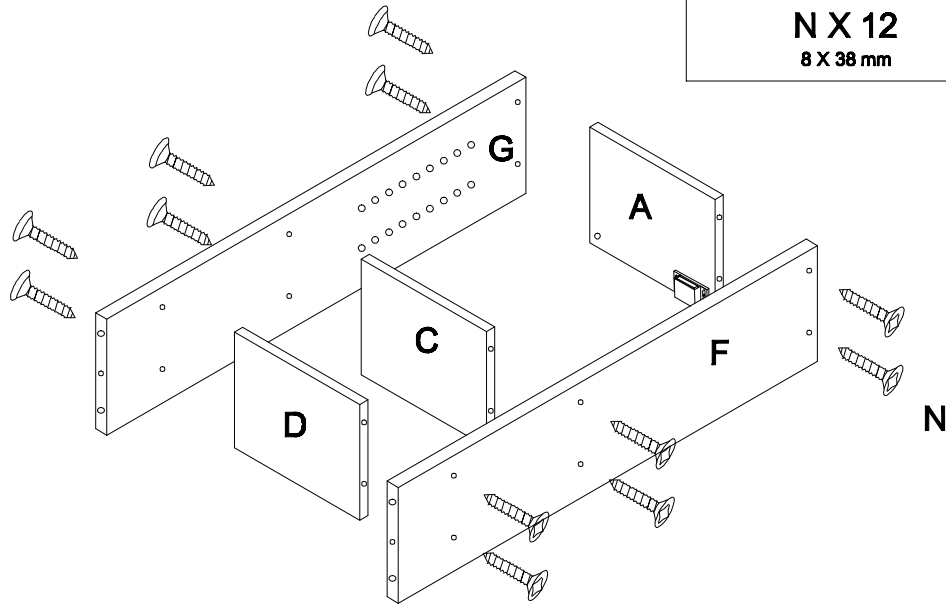

**STEP 3**

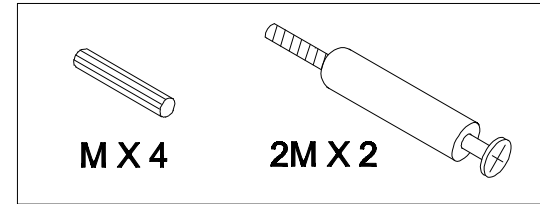
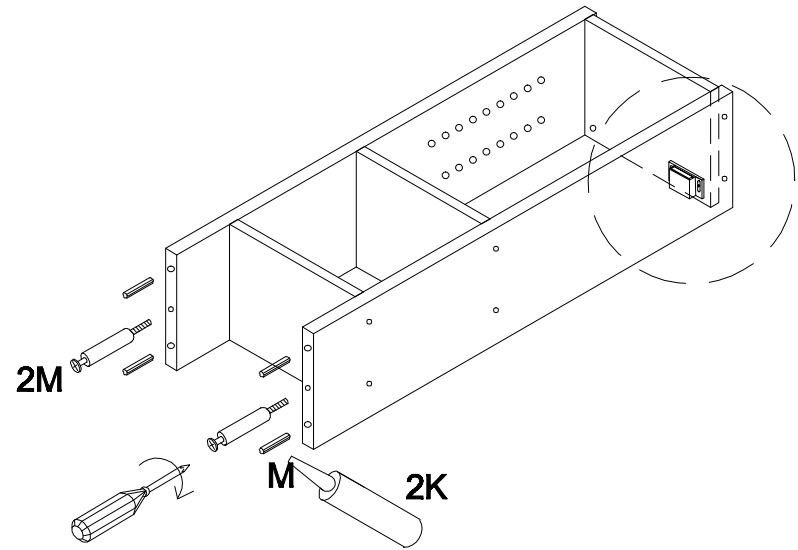

**STEP 4**

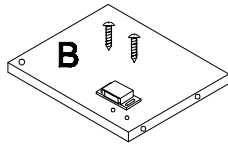
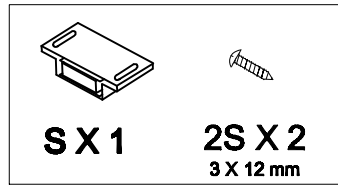

**STEP 5**

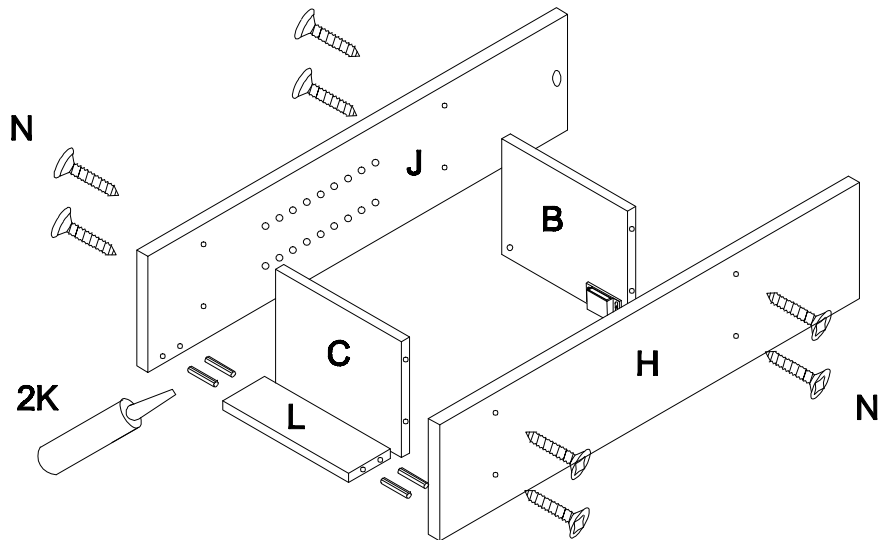
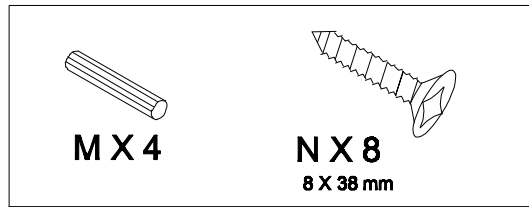

**STEP 6**

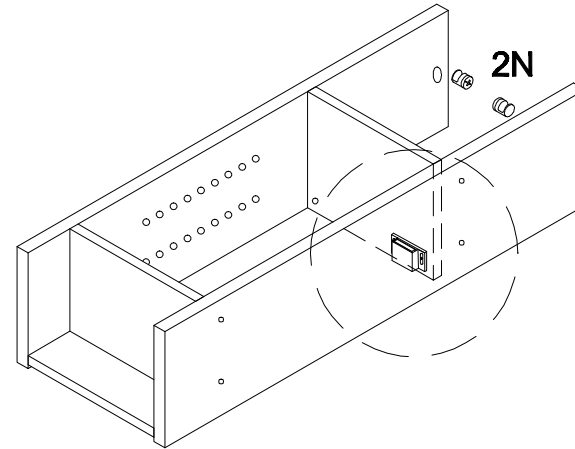
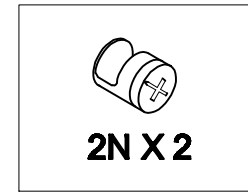

**STEP 7**

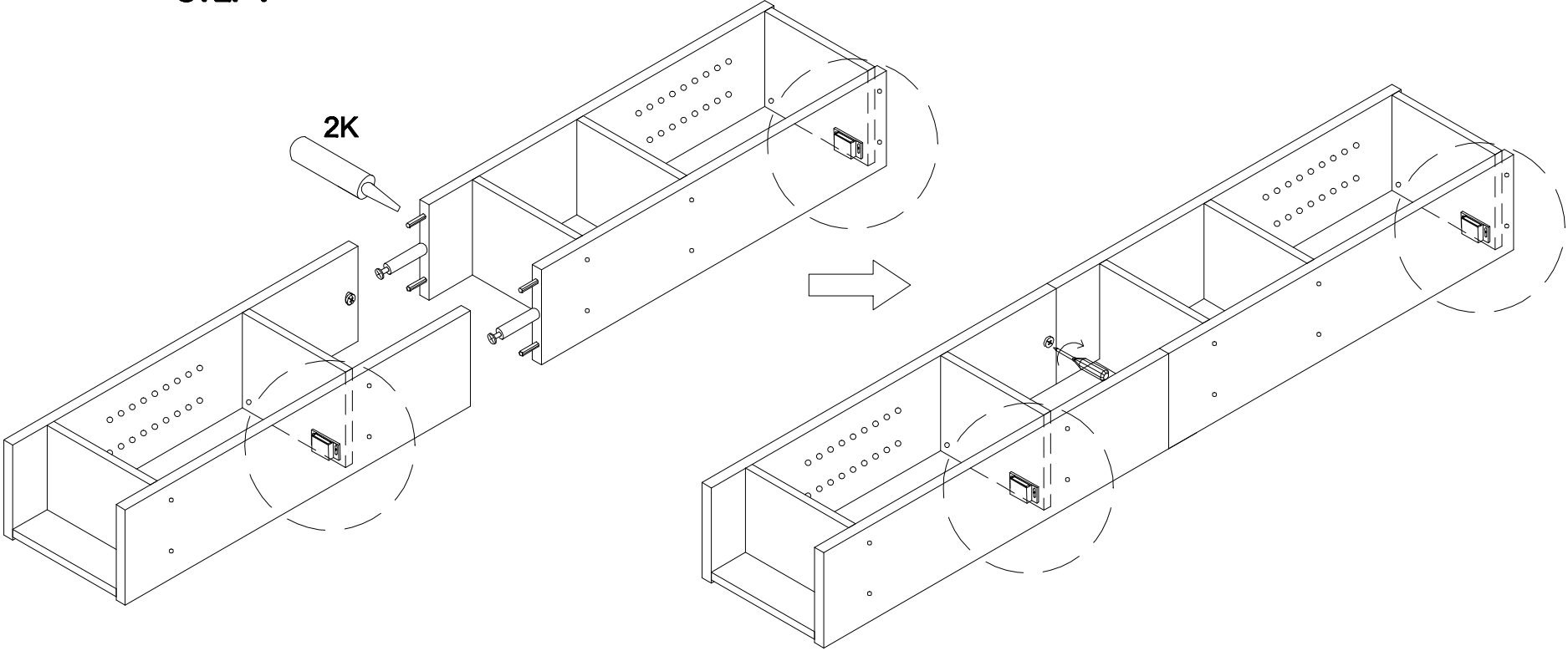

**STEP 8**

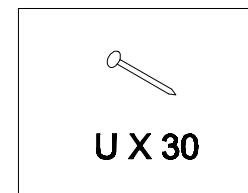
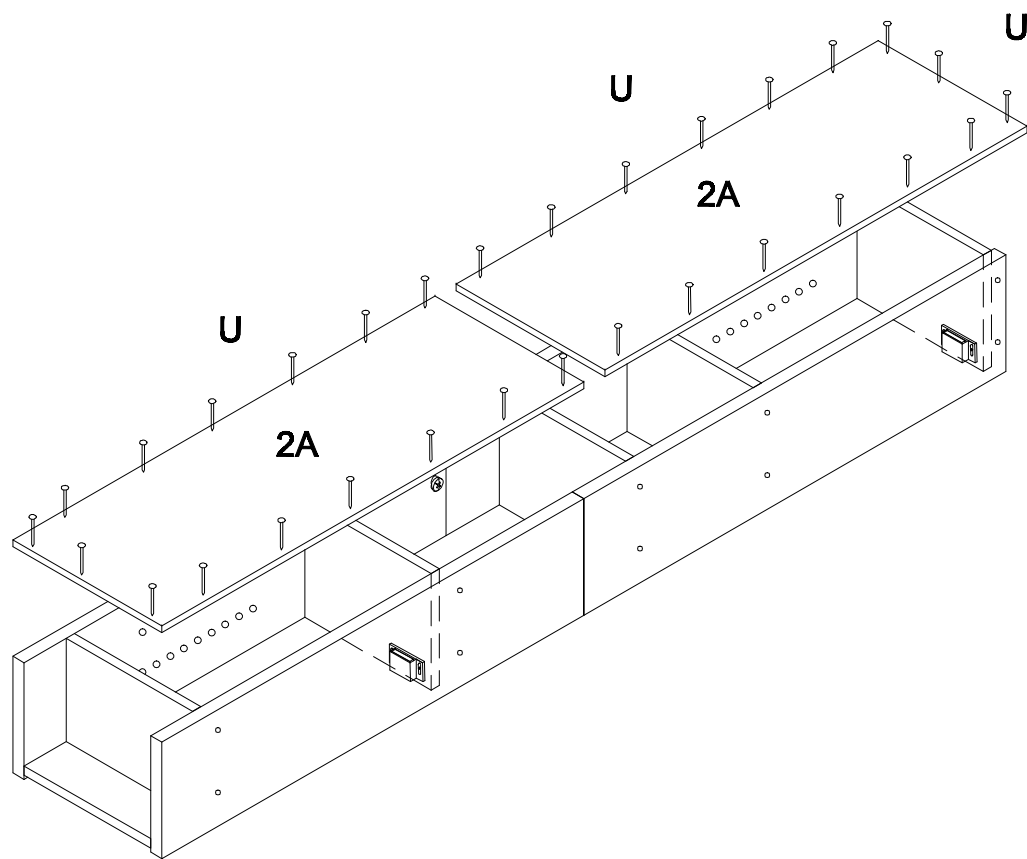

**STEP 9**

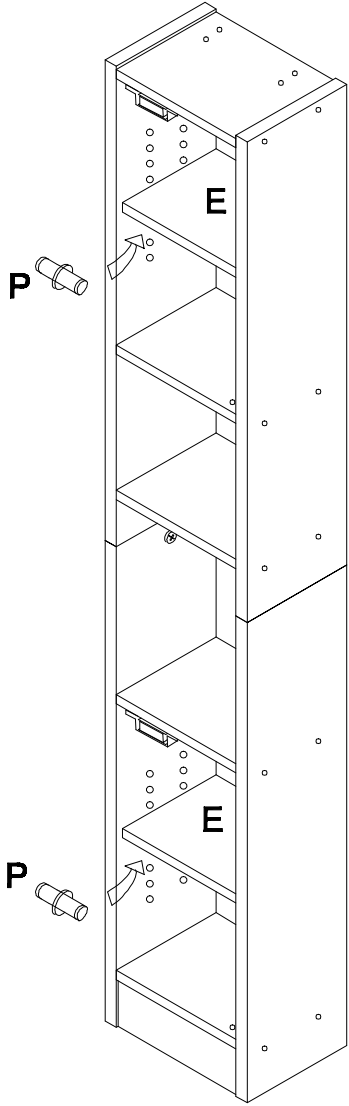
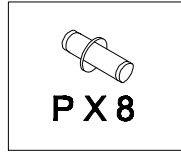

**WITH TWO PEOPLE  
STAND UP THE  
UNIT CAREFULLY  
AND PUT INTO  
PLACE !**

**STEP 10**

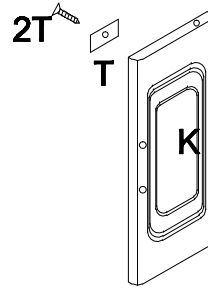
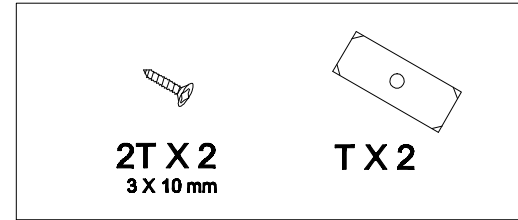

**X 2**

**STEP 11**

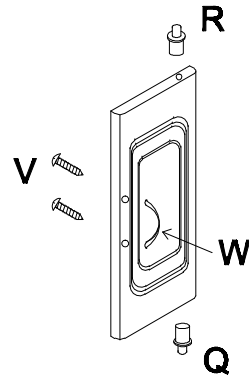
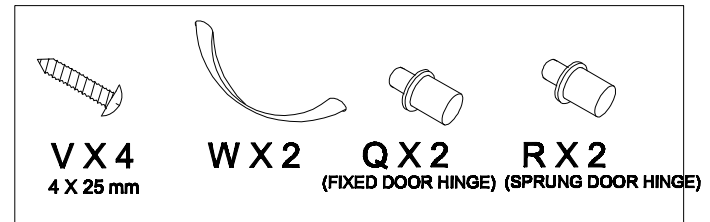

**X 2**

### STEP 12

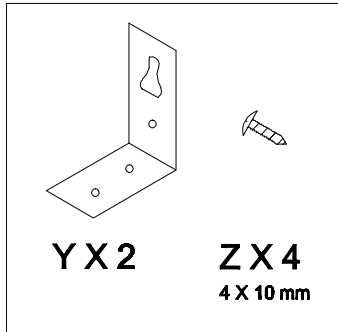
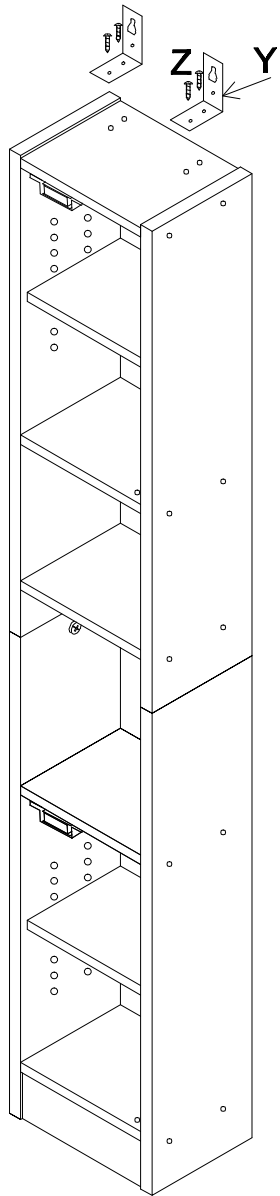

### STEP 13

