

**Body-Solid**®  
Built for Life

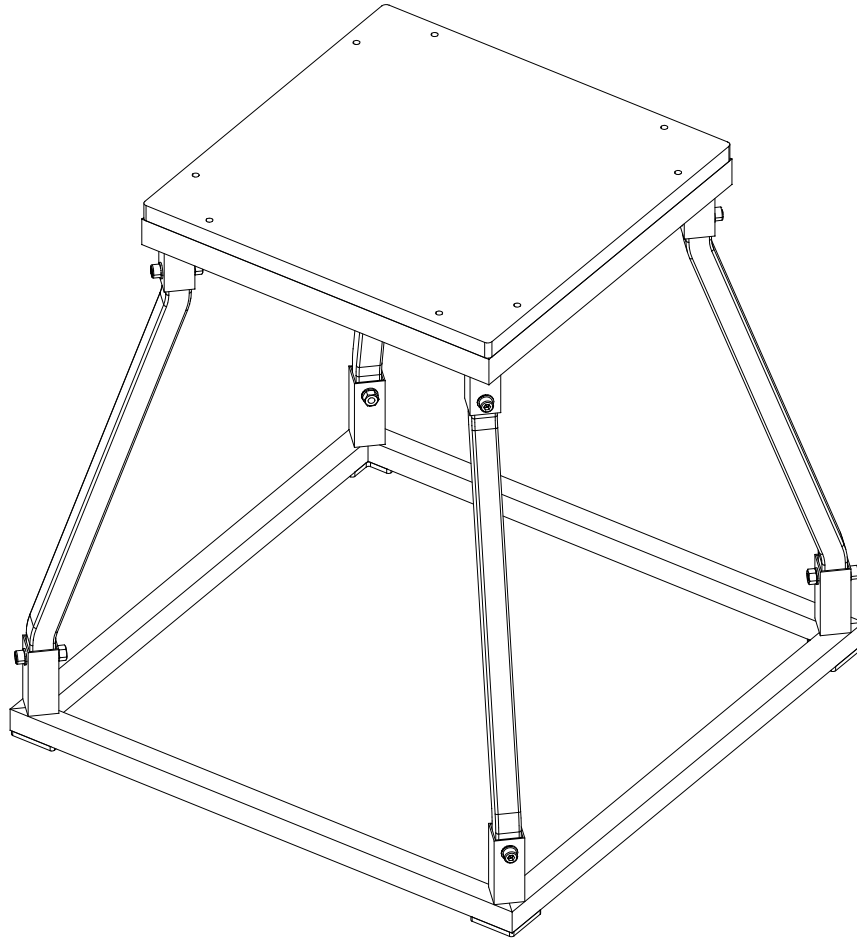

# BSTPB18

## 18 INCH PLYOMETRIC BOX

Assembly

Instructions

**OWNER'S**

**&**

**MANUAL**

## Warning, Safety & Maintenance

Be sure that all users carefully read and understand all warning, safety and maintenance labels on the machine and in the manual before each use. Failure to do so may result in death or serious injury. Body Solid Plyometric Boxes should only be used as described in this manual and Body Solid Inc. assumes no liability for accidents or damage that may occur when using this product.

It is imperative that you retain this Owner's Manual and be sure all warning labels are legible and intact. Replacement Owner's Manuals and warning labels are available from your local Body-Solid dealer.

If you have any questions about the operation, set up or maintenance of this machine please call our customer service department at 1 (800) 556-3113.

The following disclaimer states some but maybe not all **SAFETY TIPS** and **WARNINGS** that should be observed when using the Body Solid Plyometric Boxes.

### **SAFETY TIPS:**

- **USE INDOORS ON A NON SLIP FLAT / LEVEL SURFACE.**
- Plyometrics are recommended only for well-conditioned athletes.
- You should have a high level of leg strength prior to performing plyometric exercises.
- Warm up thoroughly before starting plyometric exercises.
- Start slowly with small jumps and gradually build up.
- Land softly to absorb shock.
- Allow plenty of rest between each workout.
- Stop your workout if you feel pain in your joints.
- Use only athletic shoes that have a good rubber sole on them and have plenty of cushioning.
- Only perform exercise on a box height that you are comfortable with.

### **WARNINGS**

- **DO NOT USE IF THE FRAME OR SURFACE MATERIAL IS DAMAGED.**
- **DO NOT MOVE THE PLYO-BOX WITH YOUR FEET, PICK IT UP TO MOVE TO YOUR DESIRED LOCATION.**
- **DO NOT STACK ANY OTHER ITEMS ON THE PLYO-BOX SUCH AS FREE WEIGHTS.**
- **DO NOT JUMP ON THE PLYO-BOX WHEN STACKED.**
- **DO NOT USE THE PLYO-BOX FOR ANY OTHER USE EXCEPT FOR WHAT IT IS INTENDED FOR.**

**THERE IS A RISK ASSUMED BY INDIVIDUALS WHO USE THIS TYPE OF EQUIPMENT. TO MINIMIZE RISK, YOU MUST FOLLOW THESE RULES:**

1. Inspect equipment before each workout. Check that all nuts, bolts, screws and pop pins are in place and fully tightened. Also, before use, check cables for signs of wear. Replace all worn parts immediately. Never use machine if any parts are damaged or missing.
2. **FAILURE TO FOLLOW THESE RULES MAY RESULT IN SERIOUS INJURY.**
3. Keep clear of the cables and all moving parts when the machine is in use.
4. Always make sure all Snap Links are closed when doing any cable/pulley/strap exercises.
5. Exercise with care. Perform your exercises at a smooth moderate pace; never perform jerky or uncoordinated movements that may cause injury.
6. It is recommended that you should workout with a training partner.
7. Do not allow children or minors to play on or around this equipment.
8. If unsure of proper use of equipment, call your local Body-Solid distributor or the Body-Solid customer service department at 1-800-556-3113.
9. **WARNING:** Consult your physician before starting your exercise program. For your own safety, do not begin any exercise program without proper instruction. RAL8-6-03 WC-54

## Table of Contents

- SAFETY INSTRUCTIONS..... PAGE 4
- PREPARATION..... PAGE 5
- HARDWARE / PART LIST..... PAGE 6
- HARDWARE / PART ILLUSTRATION..... PAGE 7
- ASSEMBLY INSTRUCTIONS..... PAGE 8
- EXPLODED VIEW..... PAGE 11
- CONTACT PAGE..... PAGE 12

# Important Safety Instructions

Before beginning any fitness program, you should obtain a complete physical examination from your physician.

*Il est conseillé de subir un examen médical complet avant d'entreprendre tout programme d'exercice.  
Si vous avez des étourdissements ou des faiblesses, arrêtez les exercices immédiatement.*

*Antes de comenzar cualquier programa de ejercicios, deberías tener un examen físico con su doctor.*

## **When using exercise equipment, you should always take basic precautions, including the following:**

- Read all instructions before using the BSTPB-18. These instructions are written to ensure your safety and to protect the unit.
- Do not allow children on or near the equipment.
- Use the equipment only for its intended purpose as described in this guide. Do not use accessory attachments that are not recommended by the manufacturer. Such attachments might cause injuries.
- Wear proper exercise clothing and shoes for your workout, no loose clothing.
- Use care when getting on or off the unit.
- Do not overexert yourself or work to exhaustion.
- If you feel any pain or abnormal symptoms, stop your workout immediately and consult your physician.
- Never operate unit when it has been dropped or damaged. Return the equipment to a service center for examination and repair.
- Never drop or insert objects into any opening in the equipment.
- Always check the unit before each use. Make sure all fasteners are secure and in good working condition.
- Do not use the equipment outdoors or near water.

## **Personal Safety During Assembly**

- Before beginning assembly, please take the time to read the instructions thoroughly.
- Read each step in the assembly instructions and follow the steps in sequence. Do not skip ahead. If you skip ahead, you may learn later that you have to disassemble components and that you may have damaged the equipment.
- Assemble and operate the BSTPB-18 on a solid level surface. Locate the unit a few feet from the walls or furniture to provide easy access.

The BSTPB-18 is designed for your enjoyment. By following these precautions and using common sense, you will have many safe and pleasurable hours of healthful exercise with your Body-Solid BSTPB-18.

After assembly, you should check all functions to ensure correct operation. If you experience problems, first recheck the assembly instructions to locate any possible errors made during assembly. If you are unable to correct the problem, call the dealer from whom you purchased the machine or call 1-800-556-3113 for the dealer nearest you.

## **Obtaining Service**

Please use this Owner's Manual to make sure that all parts have been included in your shipment. When ordering parts, you must use the part number and description from this Owner's Manual. Use only Body-Solid replacement parts when servicing this machine. Failure to do so will void your warranty and could result in personal injury.

For information about product operation or service, check out the official Body-Solid website at [www.bodysolid.com](http://www.bodysolid.com) or contact an authorized Body-Solid dealer or a Body-Solid factory-authorized service company or contact Body-Solid customer service at one of the following:

Toll Free: 1-800-556-3113  
Phone: 1-708-427-3555  
Fax: 1-708-427-3556  
Hours: M-F 8:30-5:00 CST  
E-Mail: [service@bodysolid.com](mailto:service@bodysolid.com)

Or write to: Body-Solid, Inc.  
Service Department  
1900 S. Des Plaines Ave.  
Forest Park, IL 60130 USA

**Retain this Owner's Manual for future reference. If you need to order replacement parts please be prepared to provide the following information when contacting us so that we can assist you better.**

- 1. Model Number**
- 2. Place of Purchase**
- 3. Part # and Description**

# Before You Begin

Thank you for purchasing the BSTPB-18. This product is part of the Body-Solid line of quality strength training equipment, which lets you target specific muscle groups to achieve better muscle tone and overall body conditioning. To maximize your use of the equipment please study this Owner's Manual thoroughly.

## Required Tools

The basic tools that you must obtain before assembling the BSTPB-18 include but are not limited to:

- Metric Allen Key Set
- Metric Wrench Set
- Adjustable Wrench
- Rubber Mallet

## Installation Requirements

Follow these installation requirements when assembling the BSTPB-18:

Set up the BSTPB-18 on a solid, flat surface. A smooth, flat surface under the machine helps keep it level. A level machine has fewer malfunctions.

Provide ample space around the machine. Open space around the machine allows for easier access.

Insert all bolts in the same direction. For aesthetic purposes, insert all bolts in the same direction unless specified (in text or illustrations) to do otherwise.

Leave room for adjustments. Tighten fasteners such as bolts, nuts, and screws so the unit is stable, but leave room for adjustments. Do not fully tighten fasteners until instructed in the assembly steps to do so.

## Assembly Tips

Read all "Notes" on each page before beginning each step.

While you may be able to assemble the BSTPB-18 using the illustrations only, important safety notes and other tips are included in the text.

Some pieces may have extra holes that you will not use. Use only those holes indicated in the instructions and illustrations.

**NOTE:** With so many assembled parts, proper alignment and adjustment is critical. While tightening the nuts and bolts, be sure to leave room for adjustments.

**NOTE:** The bottles that are marked "Poison" is your touch up paint. Keep away from children.

**CAUTION:** Obtain assistance! If you feel like you can't assemble the BSTPB-18 by yourself then do not attempt to do so as this could result in injury. Review the installation requirements before proceeding with the following steps.

Body-Solid continually seeks ways to improve the performance, specifications and product manuals in order to ensure that only superior products are released from our factories. Please take the time to carefully read through this manual thoroughly. Instructions contained in this document are not intended to cover all details or variations possible with Body-Solid equipment, or to cover every contingency that may be met in conjunction with installation, operation, maintenance or troubleshooting of the equipment. Even though we have prepared this manual with extreme care, neither the publisher nor the author can accept responsibility for any errors in, or omission from, the information given. Should additional information be required, or should situations arise that are not covered by this manual, the matter should be directed to your local Body-Solid representative, or the Service Department at Body-Solid Inc. in Forest Park, Illinois.

## Hardware / Part List

Part#	Size	Description	Quantity
1	M8X40mm	SOCKET HEAD BOLT	8 PCS.
2	M8X15mm	SOCKET HEAD BOLT	8 PCS.
3	M8	FLAT WASHER	24 PCS.
4	M8	NYLON LOCK NUT	8 PCS.
5		NON - SLIP PAD	4 PCS.
A		BASE FRAME	1 PCS.
B		SUPPORTING LEGS	4 PCS.
C		TOP FRAME	1 PCS.
D	14"X14"	SURFACE PLATE	1 PCS.

NOTE: PART #2 AS WELL AS 8 OF THE 24 WASHERS ARE PRE-INSTALLED IN TOP FRAME (C) AND PART #5 IS PRE-INSTALLED ON BASE FRAME (A).

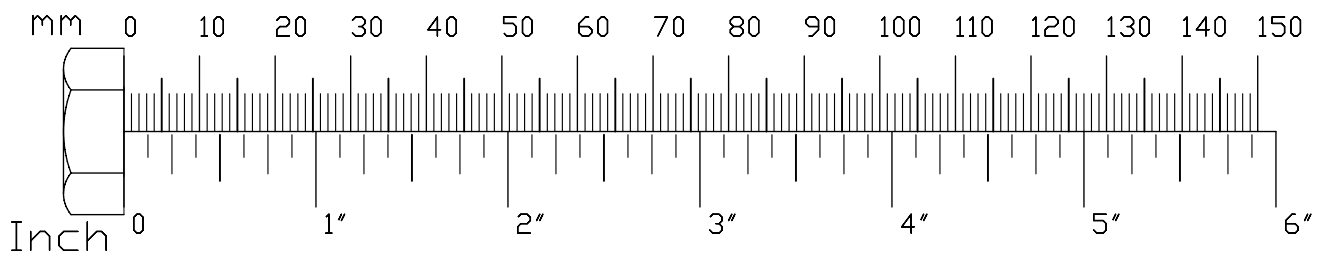

## Hardware / Part Illustration

Part #1

M8X40mm SOCKET HEAD BOLT

QTY. 8

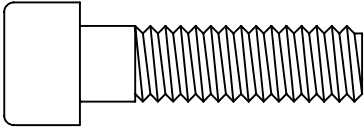

Part #2

M8X15mm SOCKET HEAD BOLT

QTY. 8

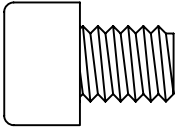

Part #3

M8 FLAT WASHER

QTY. 24

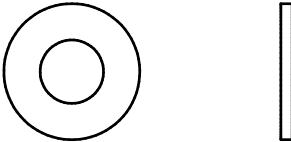

Part #4

M8 NYLON LOCK NUT

QTY. 8

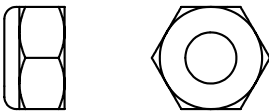

Part #5

NON - SLIP PAD

QTY. 4

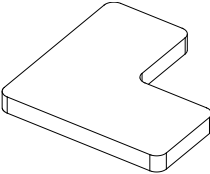

Part A

BASE FRAME

QTY. 1

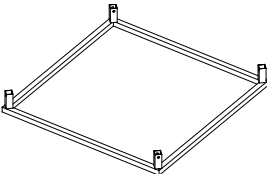

Part B

SUPPORTING LEGS

QTY. 4

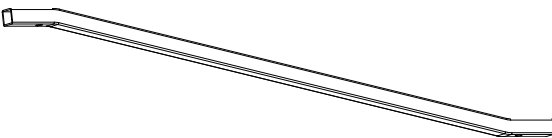

Part C

TOP FRAME

QTY. 1

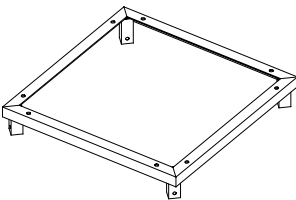

Part D

14"X14" SURFACE PLATE

QTY. 1

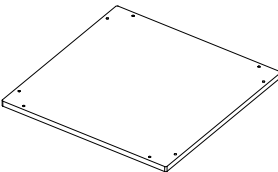

## STEP

# 1

**Be careful to assemble all components in the sequence they are presented.**

**NOTE:**

**THE LONG STRAIGHT END OF THE SUPPORTING LEGS WHICH HAS BLACK STICKER, MUST BE ATTACHED AT THE BASE.**

**Finger tighten all hardware FIRST in this step. DO NOT wrench tighten until the END. Some components may be pre-assembled. Nylon lock nuts will not fully screw onto bolts, they must be wrench tighten to fully go on.**

- 1A. Attach the long end (which has black marking) of each Supporting Leg (B) to Base Frame (A) using a total of:
- 4 - (#1) M8X40mm Socket Head Bolt
  - 8 - (#3) M8 Flat Washer
  - 4 - (#4) M8 Nylon Lock Nut
- 1B. Attach the short end of each Supporting Leg (B) to Top Frame (C) using a total of:
- 4 - (#1) M8X40mm Socket Head Bolt
  - 8 - (#3) M8 Flat Washer
  - 4 - (#4) M8 Nylon Lock Nut

NOTE: PART #2 AS WELL AS 8 OF THE 24 WASHERS ARE PRE-INSTALLED IN TOP FRAME (C) AND PART #5 IS PRE-INSTALLED ON BASE FRAME (A).



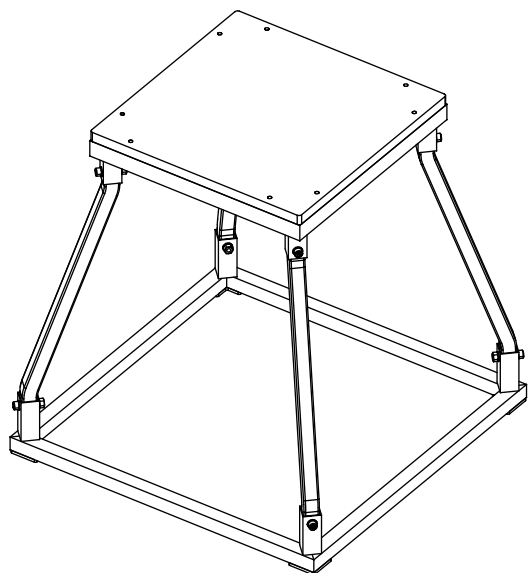

Above shows Step 1 assembled and completed.

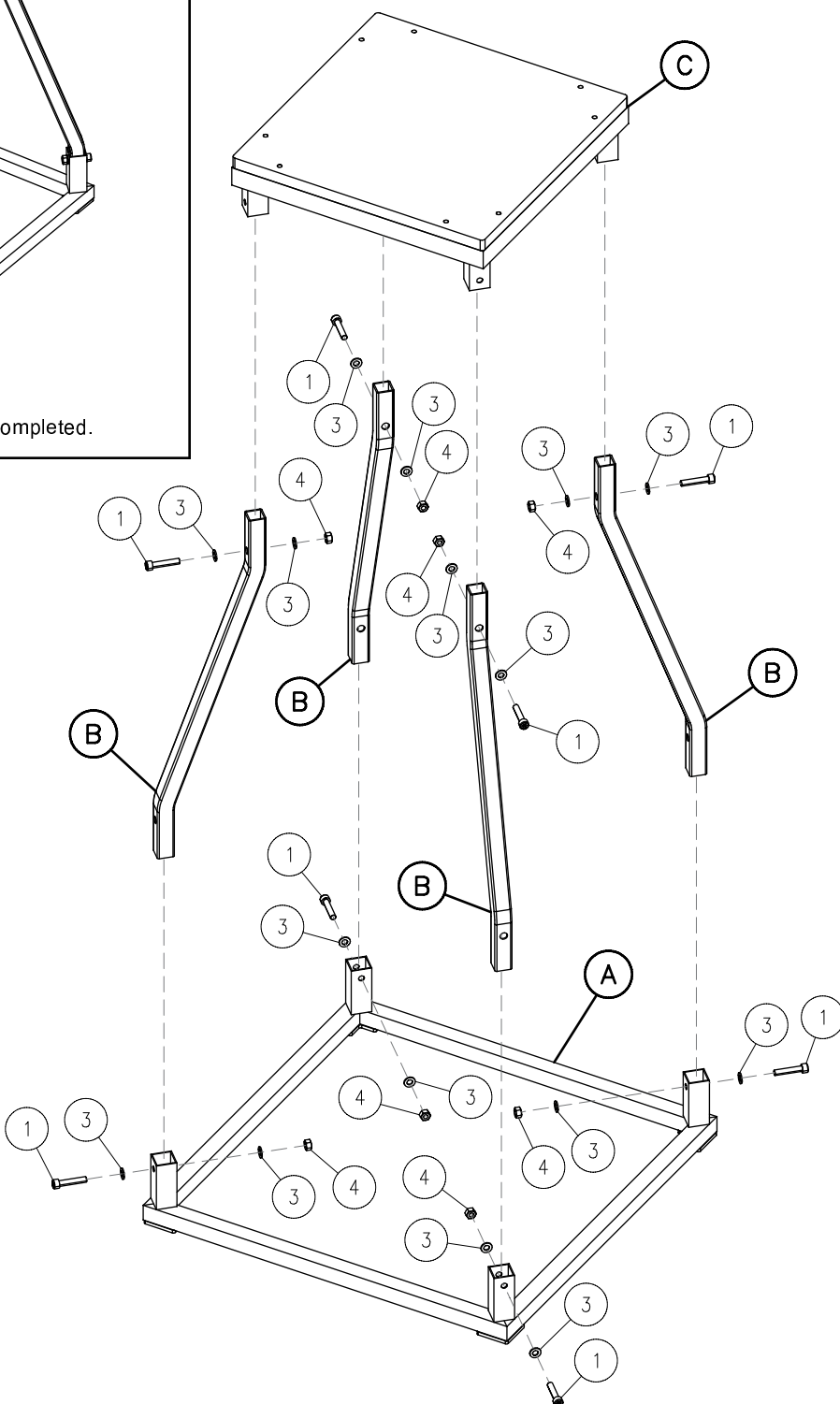

# Notes

# Exploded View

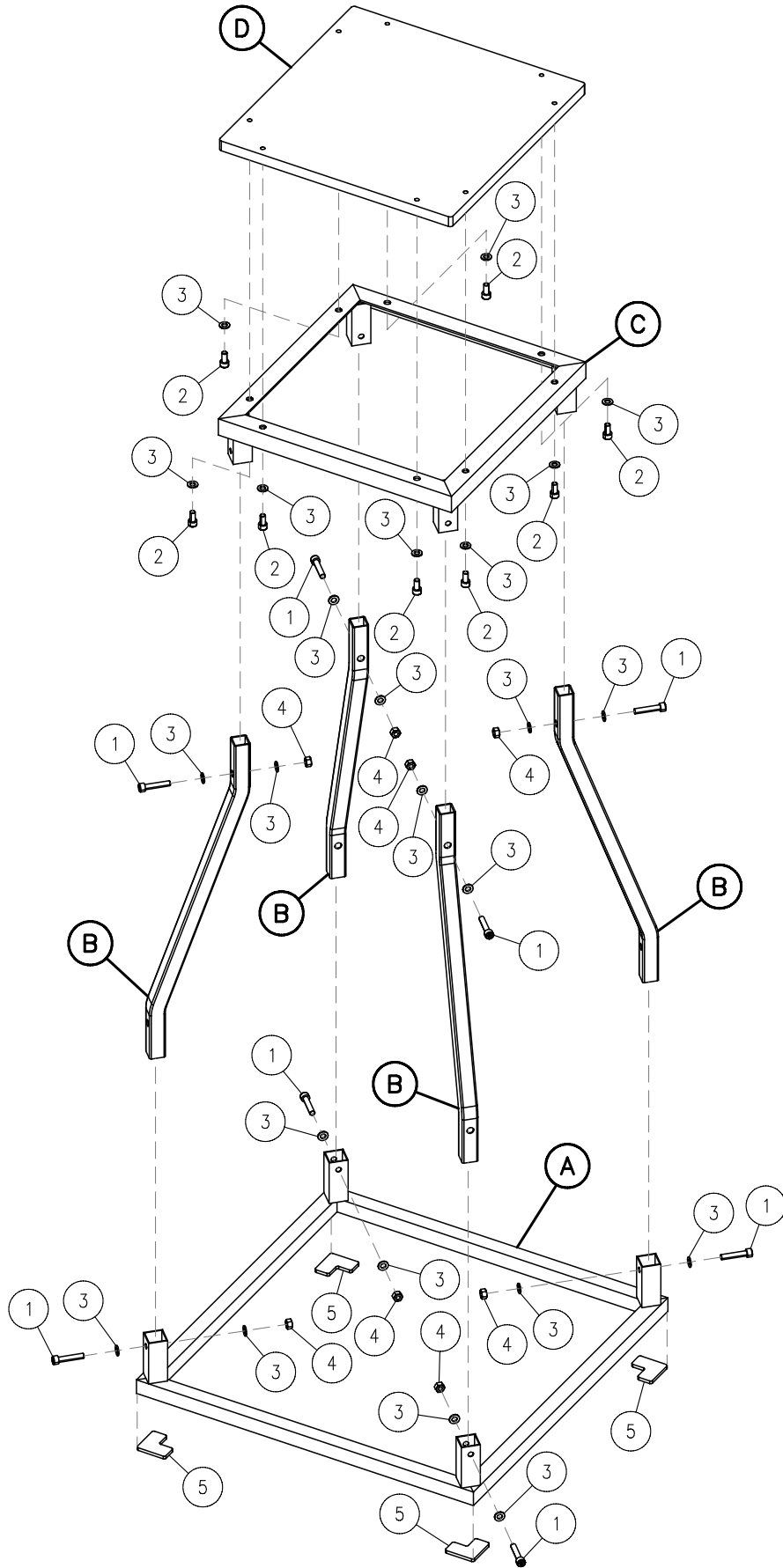

*Body-Solid*<sup>®</sup>  
Built for Life

# **BSTPB18**

## **18 INCH PLYOMETRIC BOX**

1900 S. Des Plaines Ave.  
Forest Park, IL 60130  
Phone:(708)427-3555  
Fax:(708)427-3556  
Hours: M-F 8:30 - 5:00 CST

*[www.bodysolid.com](http://www.bodysolid.com)*