

2" KISS CANOPY LED PENDANTS

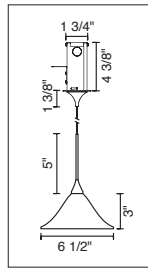

BELLA DOWN
220 091(bz,ch,mc)/MP2
220 092(bz,ch,mc)/MP2
220 094(bz,ch,mc)/MP2
220 096(bz,ch,mc)/MP2
220 099(bz,ch,mc)/MP2

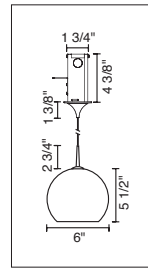

ZON DOWN
222 801bz/MP2
222 801ch/MP2
222 801mc/MP2

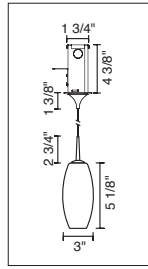

CIRO MINI LED DOWN
222 830(bz,ch,mc)/MP2
222 831(bz,ch,mc)/MP2
222 832(bz,ch,mc)/MP2
222 833(bz,ch,mc)/MP2

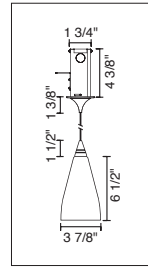

ZARA LED DOWN
222 151(bz,ch,mc)/MP2
222 152(bz,ch,mc)/MP2
222 154(bz,ch,mc)/MP2
222 156(bz,ch,mc)/MP2
222 157(bz,ch,mc)/MP2

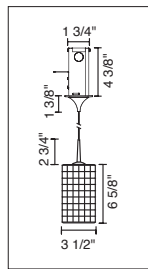

SIERRA LED DOWN
222 114bz/MP2
222 114ch/MP2
222 114mc/MP2

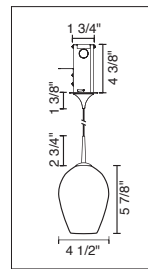

BOLERO LED DOWN
222 336(bz,ch,mc)/MP2
222 337(bz,ch,mc)/MP2
222 338(bz,ch,mc)/MP2
222 339(bz,ch,mc)/MP2

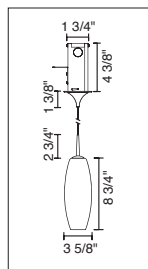

CIRO LED DOWN
222 116(bz,ch,mc)/MP2
222 119(bz,ch,mc)/MP2
222 121(bz,ch,mc)/MP2
222 122(bz,ch,mc)/MP2
222 123(bz,ch,mc)/MP2
222 124(bz,ch,mc)/MP2
222 125(bz,ch,mc)/MP2

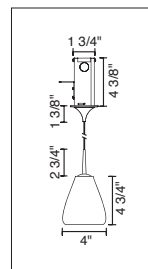

LUCY LED DOWN
222 126(bz,ch,mc)/MP2
222 127(bz,ch,mc)/MP2
222 128(bz,ch,mc)/MP2

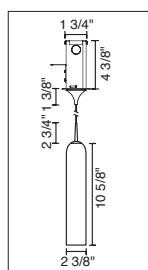

CHIANTI LED DOWN
222 820(bz,ch,mc)/MP2
222 821(bz,ch,mc)/MP2
222 822(bz,ch,mc)/MP2
222 823(bz,ch,mc)/MP2

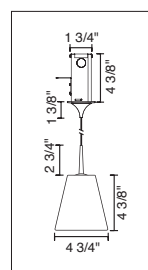

BLING I LED DOWN
222 168(bz,ch,mc)/MP2
222 173(bz,ch,mc)/MP2
222 178(bz,ch,mc)/MP2
222 840(bz,ch,mc)/MP2
222 841(bz,ch,mc)/MP2
222 842(bz,ch,mc)/MP2

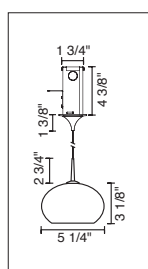

LAGUNA LED DOWN
222 810(bz,ch,mc)/MP2
222 811(bz,ch,mc)/MP2
222 812(bz,ch,mc)/MP2
222 813(bz,ch,mc)/MP2
222 814(bz,ch,mc)/MP2
222 815(bz,ch,mc)/MP2

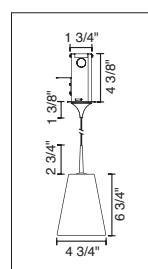

BLING II LED DOWN
222 169(bz,ch,mc)/MP2
222 174(bz,ch,mc)/MP2
222 179(bz,ch,mc)/MP2
222 843(bz,ch,mc)/MP2
222 844(bz,ch,mc)/MP2
222 845(bz,ch,mc)/MP2

2" KISS CANOPY LED PENDANTS

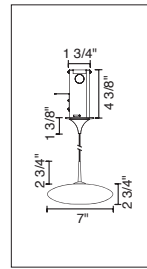

MYSTIQUE LED DOWN
222 190(bz,ch,mc)/MP2
222 191(bz,ch,mc)/MP2

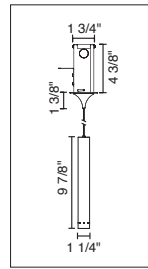

KEPLER LED DOWN
I35850ch/m/MP2
I35850mc/m/MP2
I35850-1ch/m/MP2
I35850-1mc/m/MP2

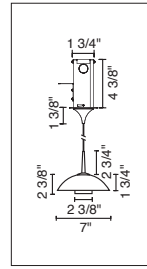

JAS LED DOWN
222 912(bz,mc)/am/MP2
222 912(bz,mc)/bl/MP2
222 912(bz,mc)/wh/MP2

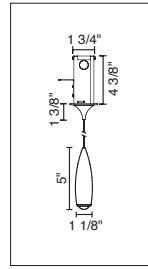

HAVANA LED DOWN
I35 721al/MP2
I35 721ch/MP2
I35 721al-1/MP2
I35 721ch-1/MP2

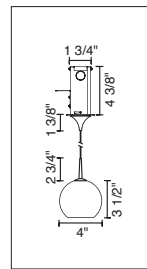

BOBO LED DOWN
222 915(bz,ch,mc)/MP2
222 917(bz,ch,mc)/MP2

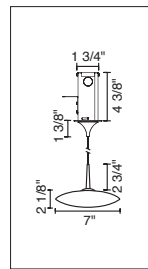

POISE LED DOWN
222 297bz/MP2
222 297ch/MP2
222 297mc/MP2

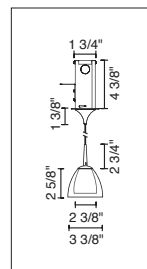

RAINBOW I LED DOWN
222 721(bz,ch,mc)/MP2
222 722(bz,ch,mc)/MP2
222 723(bz,ch,mc)/MP2
222 724(bz,ch,mc)/MP2
222 913(bz,ch,mc)/MP2
222 918(bz,ch,mc)/MP2

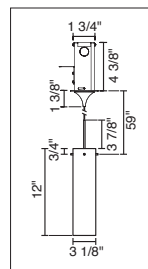

HOUSTON LED DOWN
222 850(bz,ch,mc)/MP2
222 851(bz,ch,mc)/MP2
222 852(bz,ch,mc)/MP2
222 853(bz,ch,mc)/MP2

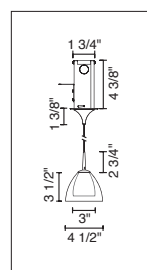

RAINBOW II LED DOWN
222 725(bz,ch,mc)/MP2
222 726(bz,ch,mc)/MP2
222 728(bz,ch,mc)/MP2
222 729(bz,ch,mc)/MP2
222 816(bz,ch,mc)/MP2
222 817(bz,ch,mc)/MP2
222 916(bz,ch,mc)/MP2
222 919(bz,ch,mc)/MP2

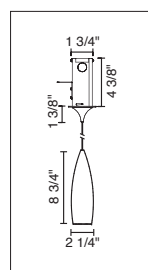

HAVANA II LED DOWN
I35 700ch/MP2
I35 700mc/MP2

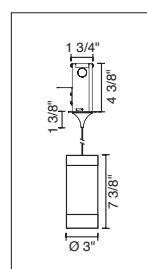

SILVA LED DOWN
222 711(bz,ch,mc)/MP2
222 712(bz,ch,mc)/MP2
222 713(bz,ch,mc)/MP2
222 714(bz,ch,mc)/MP2
222 715(bz,ch,mc)/MP2
222 716(bz,ch,mc)/MP2

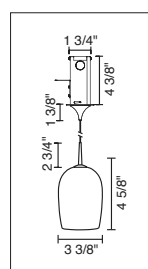

QUEENY I LED DOWN
222 321(bz,ch,mc)/MP2
222 322(bz,ch,mc)/MP2
222 323(bz,ch,mc)/MP2
222 324(bz,ch,mc)/MP2
222 325(bz,ch,mc)/MP2
222 370(bz,ch,mc)/MP2
222 371(bz,ch,mc)/MP2
222 372(bz,ch,mc)/MP2
222 373(bz,ch,mc)/MP2

2" KISS CANOPY LED PENDANTS

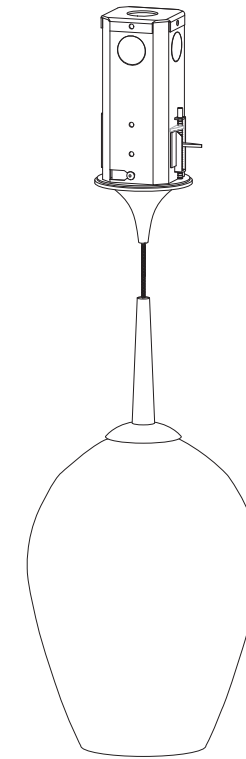

TECHNICAL SPECIFICATIONS

Description: Kiss pendant fixture with canopy and 75 Watt transformer
Design: Bruck-Team
Lamp: 3 Watt LED

CONTENTS OF DELIVERY

canopy and fixture complete



IMPORTANT SAFETY INSTRUCTIONS



1. Save these instructions and refer to them when additions to or changes to the fixture are made.
2. THIS PRODUCT MUST BE INSTALLED BY A PERSON FAMILIAR WITH THE CONSTRUCTION AND OPERATION OF THE PRODUCT AND THE HAZARDS INVOLVED, IN ACCORDANCE WITH THE APPLICABLE NEC CODE.
3. Do not install this fixture in damp or wet locations.
4. CAUTION - Do not install any fixture assembly closer than 6 inches from any curtain, or similar combustible material.
5. Turn off power prior to any work on the systems.
6. Warranty is void in case of unauthorized modifications and/ or improper use.

READ ALL OF THESE INSTRUCTIONS BEFORE INSTALLATION

INSTALLATION INSTRUCTIONS

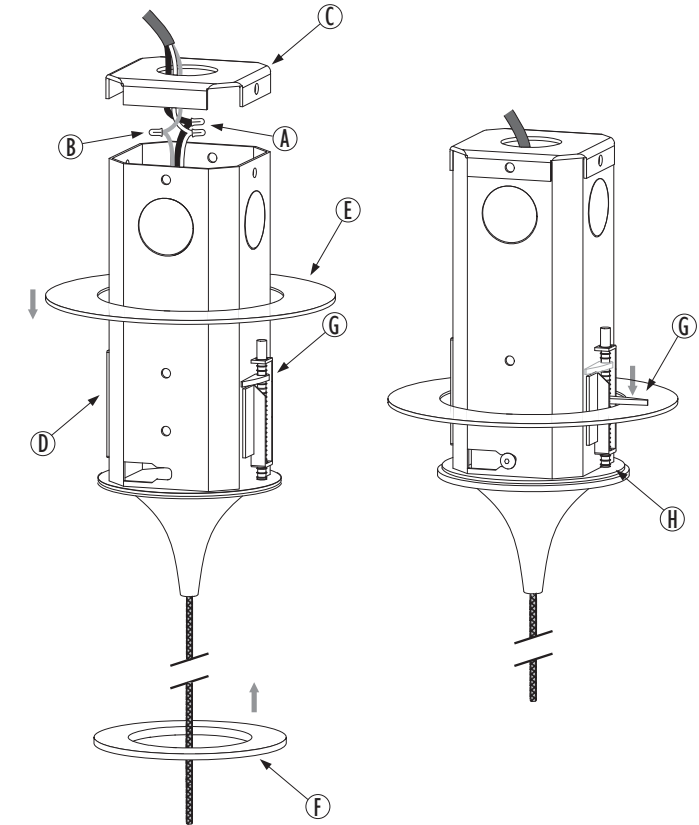

NOTE

The 2" surface mount canopy is designed for a ceiling thickness between 1-1/16" and 3/16".

INSTRUCTIONS FOR USE

- Drill a 2-1/4" hole in the mounting surface.
- Slide the j-box (D) into the mounting surface (make sure the side brackets (G) are not extended outwards). When possible, place support ring (E) over J-box.
- Tighten the mounting screws (H) to extend the side brackets and hold the j-box in place. DO NOT overtighten the screws; the side brackets may cut through the mounting surface.
- Pull the line voltage wires (A) and ground wire (B) through the back plate (C). Use wire nuts to connect the wires to the black, white, and green wires from the transformer. Attach the back plate (C) to the j-box (D) with screws.
- Place the magnetic cover-plate (F) over the j-box (D) to complete the installation.