





Assembly Instructions

SOFA

ITEM NO.:9727-3

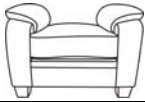
NOTE: Do not use power tools for assembly. Power tools increases the risk of over tightening which leads to splitting or cracking the wood.

COMPONENT LIST (SOFA)

| NO. | DRAWING | QTY | DESCRIPTION |
|-----|---|-----|-------------|
| A |  | 1 | SEAT FRAME |
| B |  | 1 | BACK REST |
| C |  | 4 | LEG |
| D |  | 4 | GASKET |

Step # 1

Upright the back rest from seat frame.

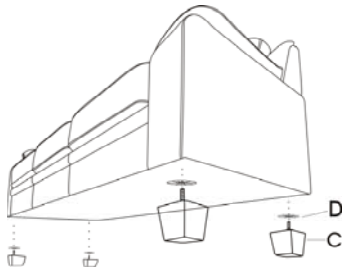

Step # 2

Insert the legs to the pre-drilled holes and tighten it.

Step # 3

Insert two female metal grooves (chair back) onto the male brackets (chair seat) as shown.

Note: Press down seat back gently until it sounds “click”, make sure it is locked in place.

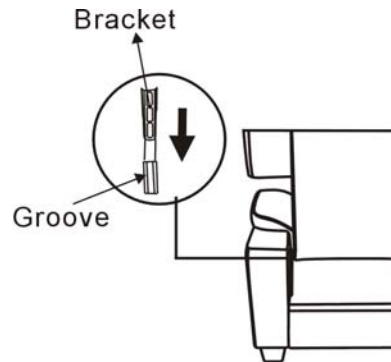

Step # 4

Sofa assembly is completed.

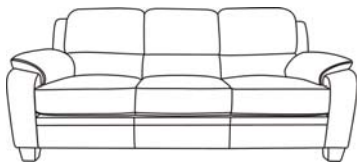

Standard Care Procedures for Fabric Furniture.

In order to preserve the original appearance of your fabric furniture, please follow below simple care procedures:

- Avoid exposing furniture directly to sunlight or heating and air conditioning outlets. Sunlight and/or exposure to heating and air conditioning outlets will fade/damage fabrics. Do not place your upholstered furniture too close to windows, radiators, or vents, and be sure to use window treatments to block the sun's rays.
- Vacuum or wipe with a soft brush to remove dust.
- Clean fabric with professional cleanser.