



ASSEMBLY INSTRUCTIONS

ITEM NO: 710 -40

Remarks: Do not tighten screws until completely assembled.

NO	Description	Drawing	Size	Q'ty
A	Spring Washer		∅ M12mm	4 pcs
B	Flat Washer		∅ M18mm	4 pcs
C	Hex Bolt		∅ M8X60mm	4 pcs
D	Spanner			1 pc

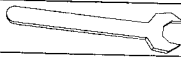
Step 1

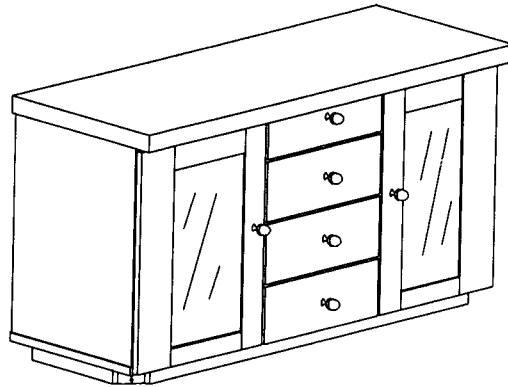

Step 2

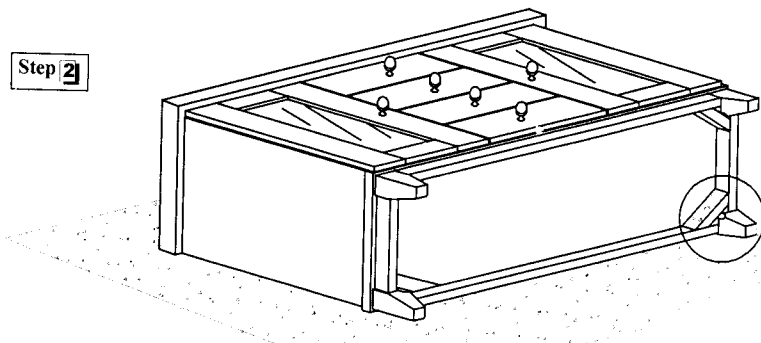

(Figure. a)

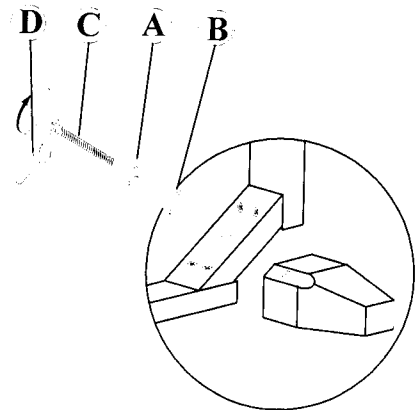

(Figure. b)

Remarks: Turn server upside down on a smooth, soft surface.

Remarks: Do not exceeding 90° angle for open this door.

Step 3

