

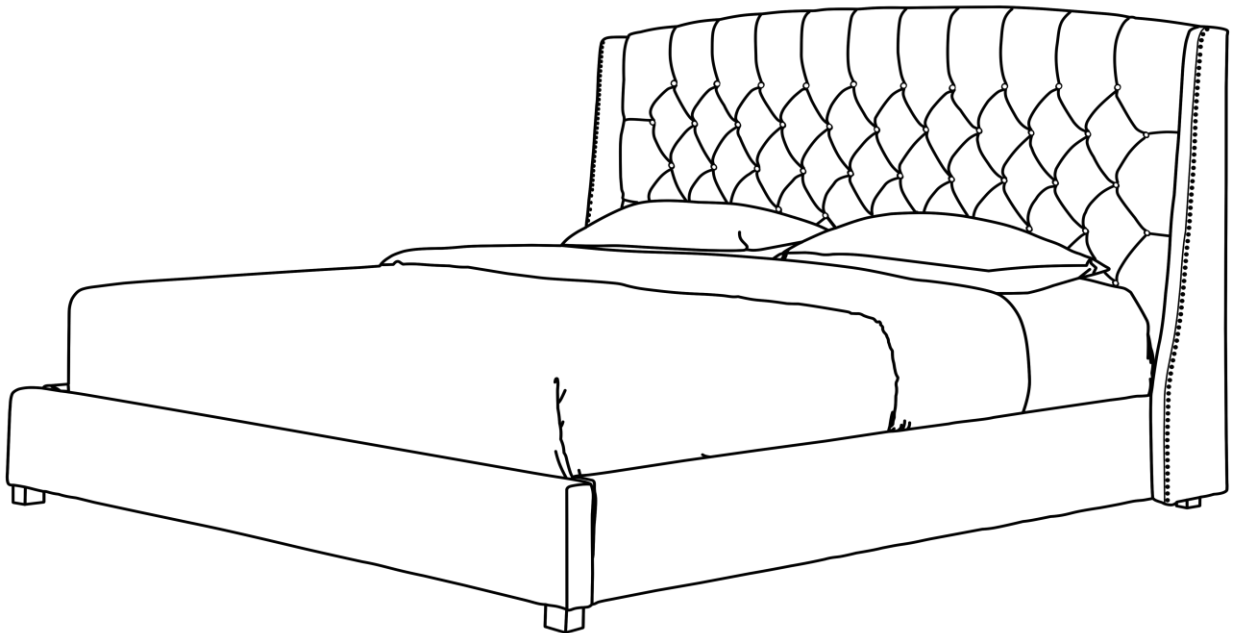





# Assembly Instruction



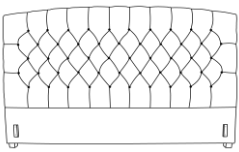

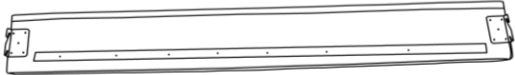

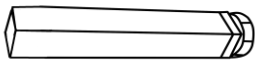
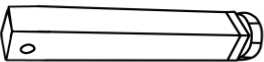



## **Williamsburg Bed** **TOV-63805**

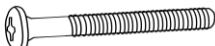

## Parts List

Label	Picture	Description	QTY
A	 A line drawing of a headboard with a diamond-patterned tufted top and a simple rectangular base.	Headboard	1
B	 A line drawing of a curved, wedge-shaped piece, likely a headboard ear, with a decorative edge.	Ear	2
C	 A line drawing of a long, narrow rectangular board with small feet at each end, likely a sideboard.	Sideboard	2
D	 A line drawing of a long, narrow rectangular board with decorative feet at each end, likely a footboard.	Footboard	1
E	 A line drawing of a rectangular frame with multiple parallel slats, likely a keel frame.	Keel Frame	2
F	 A line drawing of a cylindrical leg with a decorative band at one end, likely a side leg for the keel frame.	Keel Frame Side Leg	4
G	 A line drawing of a cylindrical leg with a decorative band at one end and a small hole at the other, likely a middle leg for the keel frame.	Keel Frame Middle Leg	2

## Hardware

Label	Picture	Description	QTY
H		Ear Screw	8
I		Spring Washer	8
J		Metal Gasket	8
K		Wrench	1
L		Keel Frame Side Leg Screw	4
M		Fixed Clip	4
N		Keel Frame Middle Leg Screw	2
O		Keel Frame Middle Leg Screw	2
P		Middle Leg Screw Nut	4
Q		Wrench	1

## Assembly Preparation

Before Beginning Assembly:



- Read instructions, cover to cover-



- Have 2 adults on hand for assembly-



- Do not assemble on flooring or carpet-



- Assemble on a clean non-marring surface (packing foam)-



- Save all packaging until finished-

# Assembly Steps

## Step 1

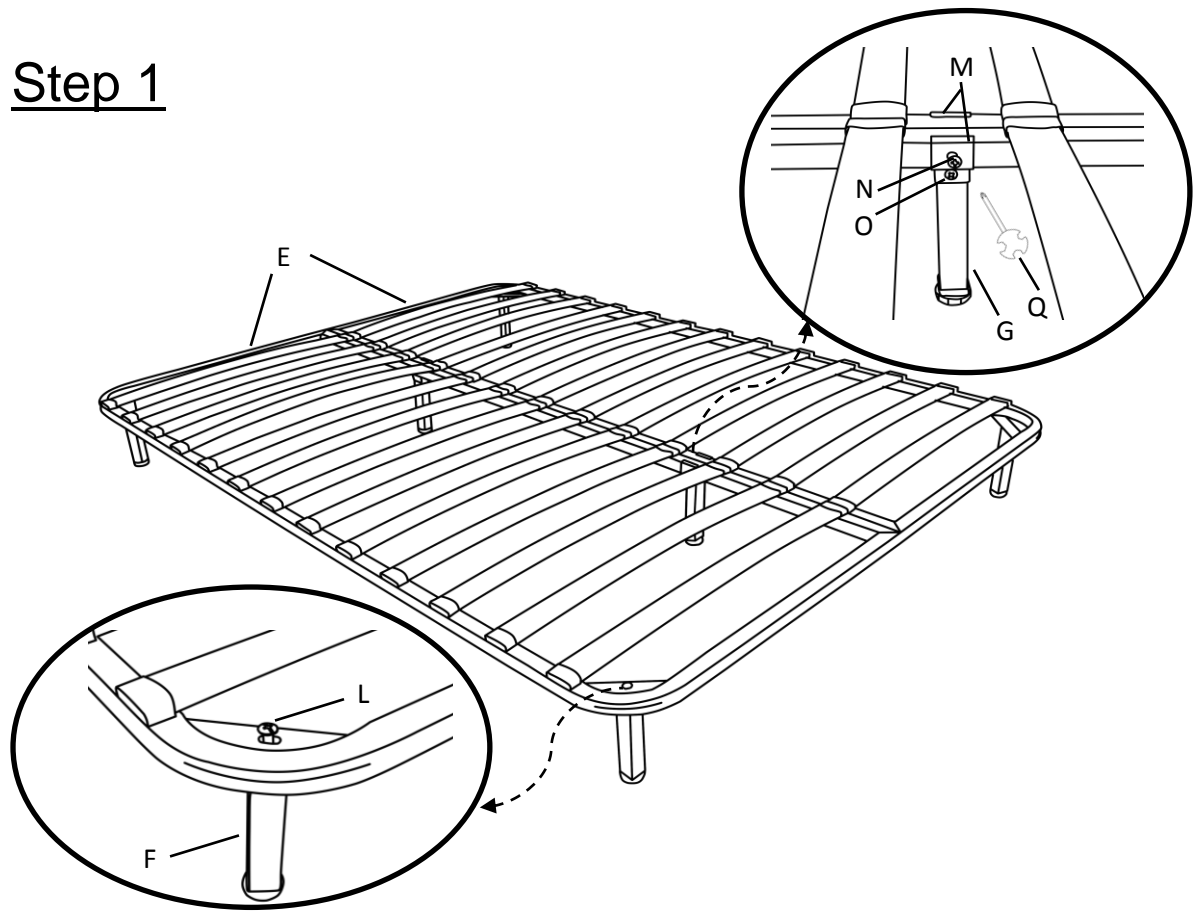

## Step 2

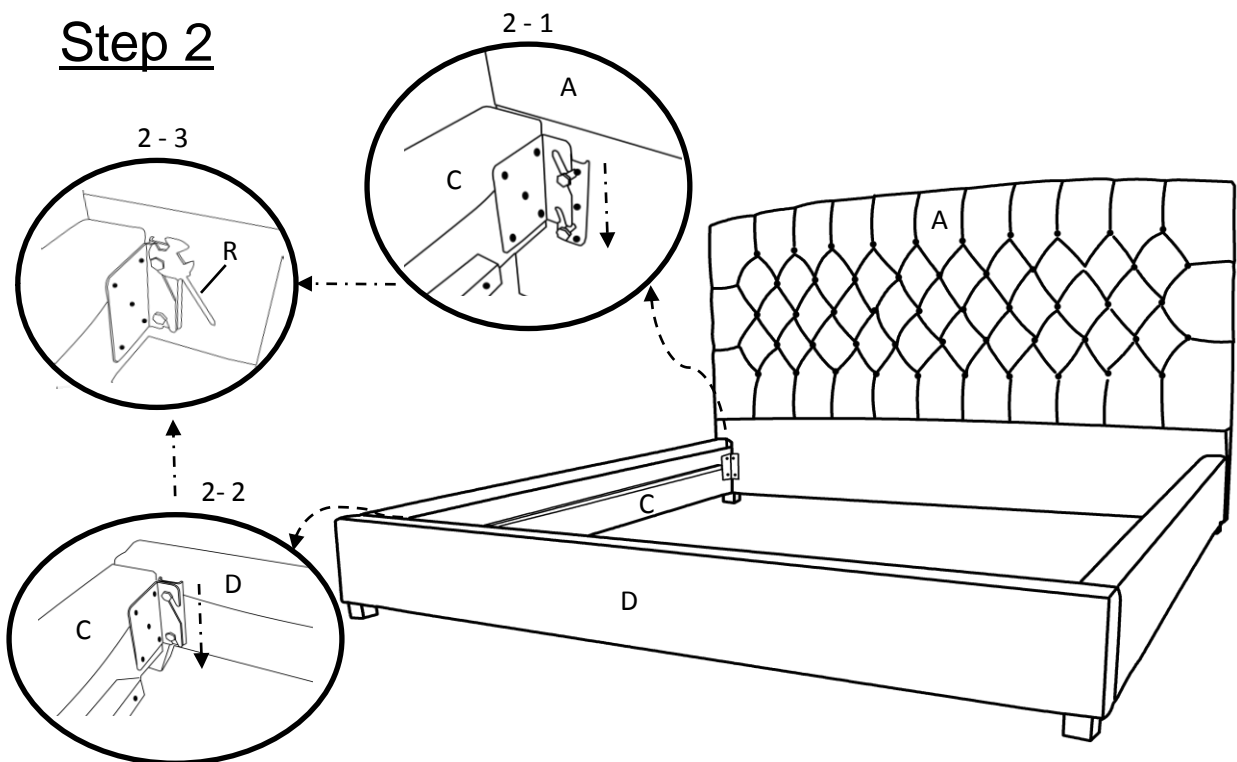

### Step 3

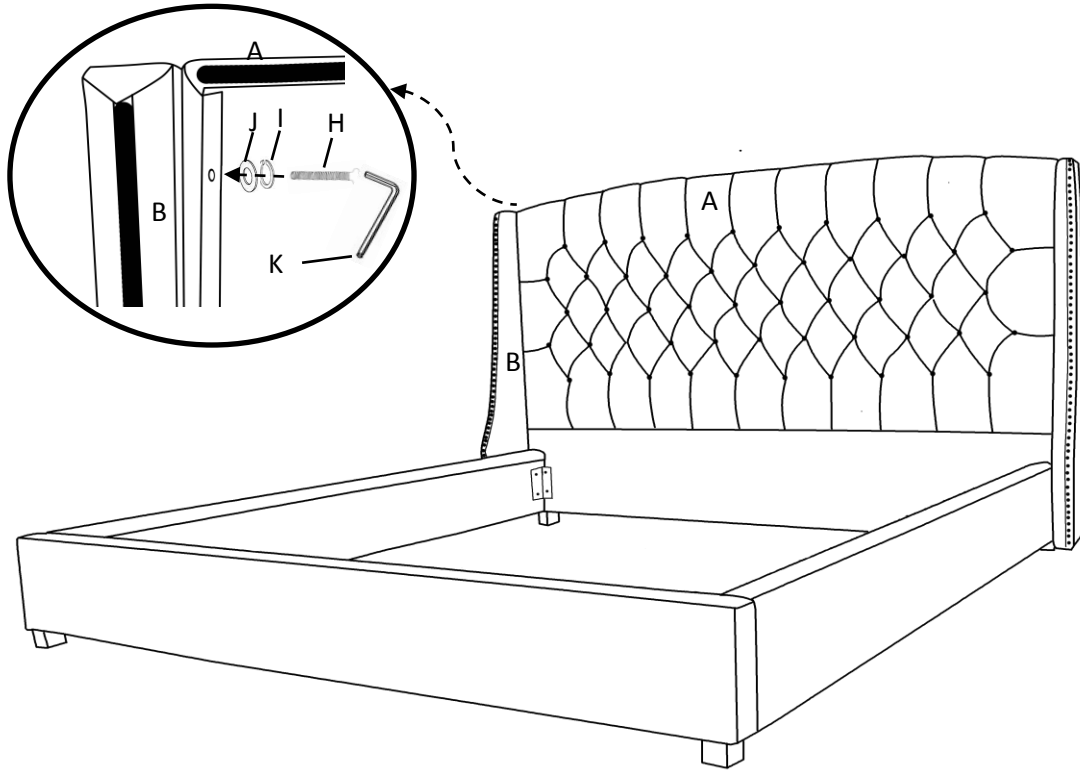

### Step 4

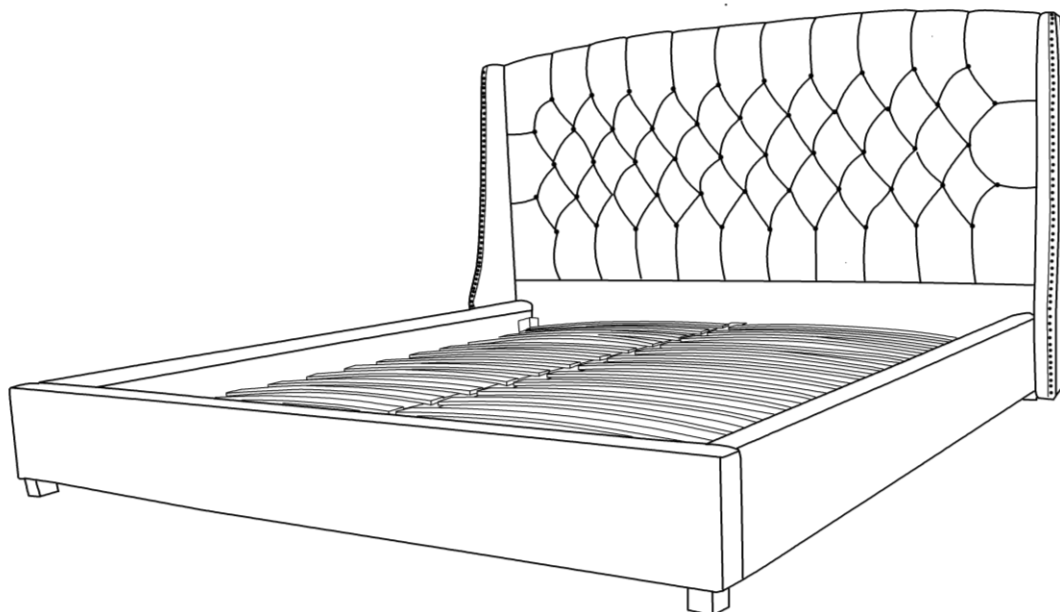

## Care & Maintenance



• Do not put hot items directly on furniture surface.



• Do not clean furniture with harsh cleansers or polish.



• Do not place furniture under direct sunlight.



• Do not place furniture near heating or cooling vents.



• Do not write on furniture without a padded barrier to protect the surface.



• Do not place furniture outside. For indoor use only.



• Not for commercial use. For residential use only.



• Stains may be removed with mild soap solution and damp cloth.



• Dust and pick-up spills using a clean, non-colored, lint-free cloth.