

1310 INSTALLATION INSTRUCTIONS

GENERAL

- To insure the success this fixture installation, the following instructions and diagram(s) should be read and understood. All electrical connections must be made in accordance with the National Electric Code and local codes and ordinances. If you are uncertain of the methods of installing electrical wiring and lighting fixtures, secure the services of a qualified licensed electrician.
 - TOOLS NEEDED:** Chain pliers, flat-blade screwdriver, small phillips screwdriver adjustable wrench or slip-joint pliers, wire cutter/stripper, electrical current tester, stepladder and electrical tape.
- NOTE:** The important safeguards and instructions outlined on this sheet cannot cover all possible conditions and situations that may occur. It must be understood that common sense, caution and care are factors that cannot be built into any product. Caution and care must be supplied by the person(s) installing, operating and caring for this lighting fixture.

INSTALLATION PREPARATION

- TURN OFF THE ENTIRE ELECTRICAL CIRCUIT TO WHICH THE LIGHTING FIXTURE IS TO BE ATTACHED.**
Move the appropriate circuit breaker to the "off" position or completely remove the fuse controlling the circuit.
- If an existing fixture is being replaced, remove it and note to which of the wires in the outlet box the fixture was attached. **DO NOT SEPARATE ANY OTHER WIRES THAT MAY BE IN THE BOX. DO NOT DAMAGE THE INSULATION OF OLDER WIRING.** In regular circumstances the BLACK wire will be the "Hot" lead and the WHITE wire will be the "Neutral" or "Common" lead. A GREEN or BARE COPPER wire is the "Ground". In older buildings it is always good practice to reconfirm the polarity of the wiring.
- This fixture is designed to be mounted on a correctly installed, standard round or octagon box or a through wiring box with a plaster frame. The box must be securely mounted to the structure of the building.

FIXTURE PREPARATION

- Remove the fixture, parts, shades and parts bag(s) from the carton.
Before discarding the carton, double check to make certain that all parts are found.
- Install the curved glass panels. Remove the butterfly clips from the support columns. Place the glass in position and reinstall the clips.

FIXTURE INSTALLATION

- Attach the crossbar to the outlet box. (The green screw should face the floor).
- Remove the threaded ring from the screwcollar loop. Fully thread the loop onto the nipple. Thread the hex nut onto the nipple and the nipple into the crossbar. Place the canopy over the screwcollar loop and against the ceiling. Adjust the nipple so that 1/4" of threads on the screwcollar loop extend beyond the canopy. Tighten the hex nut against the crossbar.
- Open end links of chain and attach the chain to the screwcollar loop. Close the top link of chain. Hang the fixture on the chain at the desired height. Remove excess chain. Close the bottom link of chain.
- Unscrew the ring from the screwcollar loop. Let the ring and canopy slide down the chain to the top of the fixture. Thread the lead wires and ground wire (first) through the ring and then the canopy. Thread the wires up through alternating links of the chain to the outlet box.
- Measure 6" of lead wire beyond the end of the chain. Cut off excess wire. Strip the insulation off the ends of the leads exposing approx. 1/2" of wire. Twist the strands of wire together. Push the leads and ground wire up through the screwcollar loop and nipple and into the outlet box.
- Fasten the bare ground wire to the green or bare copper wire in the outlet box or the green screw on the crossbar.
NEVER FASTEN THE GROUND WIRE TO THE BLACK OR "HOT" WIRE ! FAILURE TO FOLLOW THIS INSTRUCTION COULD RESULT IN SERIOUS INJURY OR DEATH !
- Fasten the fixture lead with the ridge(s) to the white wire in the outlet box. Fasten the wires together with an approved fastener (wire nut) Starting about 1" below the fastener, tightly wrap the connection with electrical tape so that the tape seals the end of the fastener.
Make sure that there is no exposed wire or strands that could cause a dangerous short circuit !

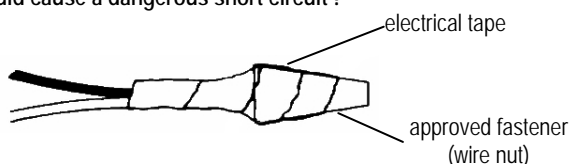
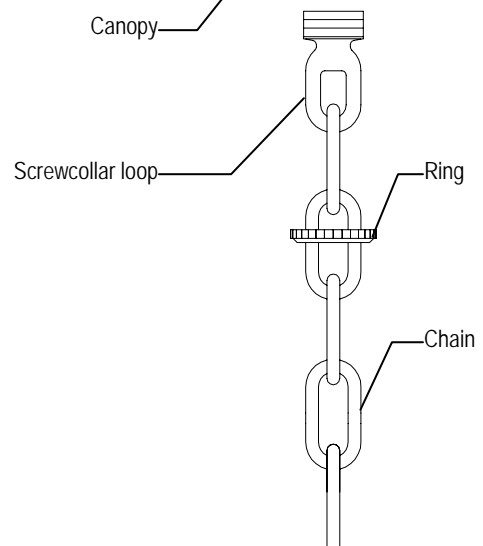
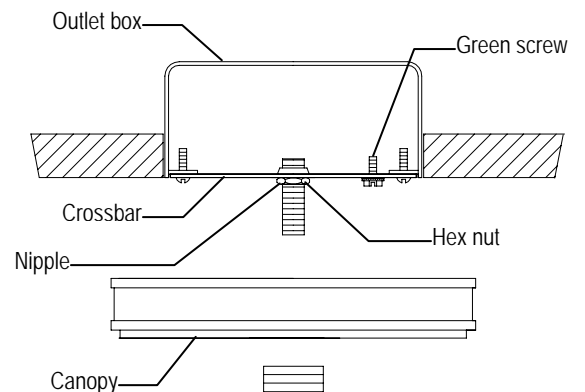
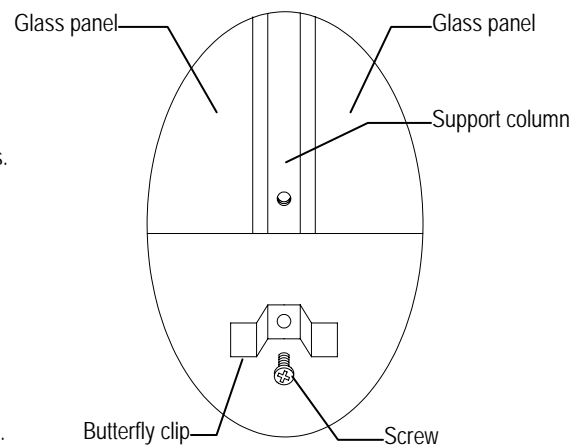

8. Connect the smooth fixture lead to the black wire in the outlet box.
Fasten the joined wires as in step 7.
9. Slide the canopy and screwcollar ring up the chain and secure the canopy to the ceiling.
10. Install the lamps (light bulbs).
NOTE: This fixture is rated for 60 watt type B, BA, C or CA lamps.
DO NOT EXCEED RECOMMENDED WATTAGE !
11. Restore power to circuit at breaker or fuse box.

