

DROP-IN SINKS

One Compartment - FOR GENERAL PURPOSE USE



Sinks Include Faucet & Drain

Item #: _____ Qty #: _____
 Model #: _____
 Project #: _____



DI-1-168
18 Gauge



DI-1-208
18 Gauge



DI-1-2012
18 Gauge



DI-1-30
20 Gauge



DROP-IN FILLER STATION

DI-1-9
20 Gauge

LARGEST ONE COMPARTMENT DROP-IN SINK IN THE INDUSTRY!

Supplied with K-53 Faucet

DI-1-2812
16 Gauge



FEATURES:

One piece seamless **Deep Drawn** sink bowl design. All sink bowls have a large liberal radii with a minimum dimension of 2" and are rectangular in design for increased capacity. Self-Rim Design. Mounting clips provided accomodate all thicknesses of counter. (Quantity supplied varies based on drop in sink ordered).

- DI-1-30 & DI-1-168:** includes 4" O.C. **K-52** faucet.
- DI-1-208 & DI-1-2012:** includes 4" O.C. **K-50** faucet.
- DI-1-2812:** includes 4" O.C. **K-53** faucet.
- DI-1-9:** includes single hole **K-54** filler faucet.

DI-1-9 has Removable Electro-Polished stainless steel grill.

CONSTRUCTION:

Unit fabricated from one sheet of stainless steel. All bowls are Sound Deadened. Units feature Advance Tabco's **Smart Finish™**.

MECHANICAL:

Faucet supply is 1/2" IPS male thread. Deck mounted faucet is furnished with aerator. **DI-1-9** includes deck mounted faucet furnished with "Push-Back" actuator.

MATERIAL:

Type 304 series stainless steel. Faucets are brass-nickel plated. Stainless Steel 1-1/2" IPS basket drain.



STANDARD MOUNTING CLIPS accomodate all thicknesses of counter.

Replacement # **K-28** (Per Sink)

Available Faucets & Accessories	Model #	Qty
Deck Mounted 8" Swing Spout. 4" O.C.	K-50	
Deck Mounted Gooseneck. 4" O.C.	K-52	
Deck Mounted. 12" Swing Spout. 4" O.C.	K-53	
Water Filler Faucet (Single Hole)*	K-54	
Deck Mounted 8 1/2" Gooseneck. 4" O.C.	K-55	
Deck Mounted Swing w/Spray. 8" O.C.*	K-58	
Deck Mtd. X.H.D. 3 1/2" Gooseneck. 4" O.C.	K-62	
Mounting Clips (Bag of 4).	K-28	

*REQUIRES **K-472** FAUCET HOLE REVISION

Standard Faucet conforms to NSF 61 Standard 9. An optional faucet upgrade is required for compliance to AB 1953 Standards.

For Replacement Faucets & Upgrades, Drains & Accessories visit our website at www.advancetabco.com

DIMENSIONS and SPECIFICATIONS

TOL ± .125"

ALL DIMENSIONS ARE TYPICAL

DI-1-208 & DI-1-2012

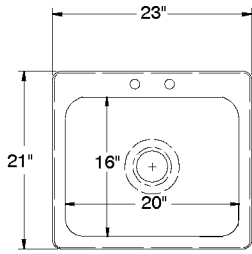

Cut-Out Size
22 1/4" x 20 1/4"
1 1/4" radius corners

DI-1-208

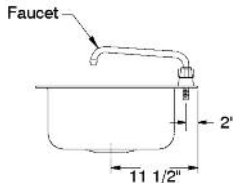

Approx. Wt. 18 lbs.

DI-1-2012

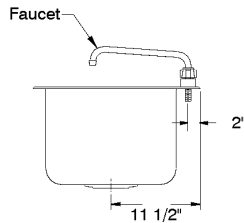
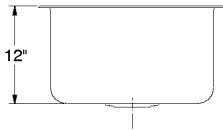

Approx. Wt. 20 lbs.

Supplied with K-50 Faucet

DI-1-2812

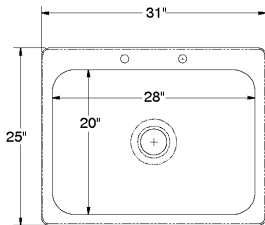

Cut-out Size
30 1/4" x 24 1/4"
1 1/4" radius corners

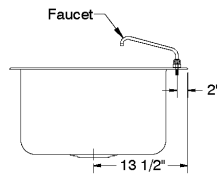
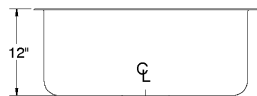

Approx. Wt. 42 lbs.

Supplied with K-53 Faucet

TYPICAL INSTALLATION

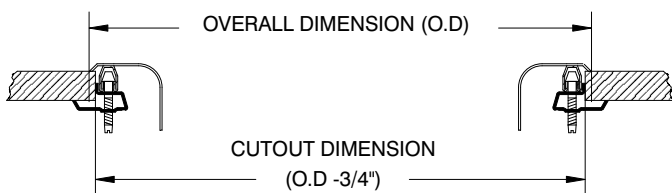

Cut-Out Size = L to R x F to B

DI-1-168

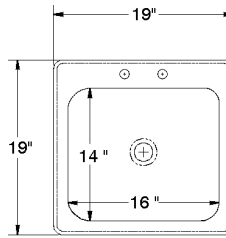

Cut-out Size
18 1/4" x 18 1/4"
1 1/4" radius corners

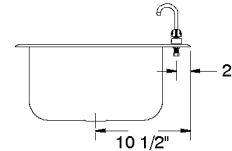
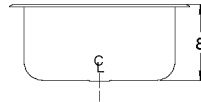

Approx. Wt. 15 lbs.

Supplied with K-52 Faucet

DI-1-30

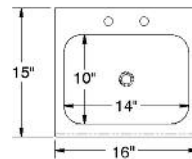

Cut-Out Size
15" x 14 1/4"
1 1/4" radius corners

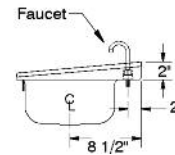
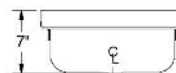

Approx. Wt. 11 lbs.

Supplied with K-52 Faucet

DI-1-9

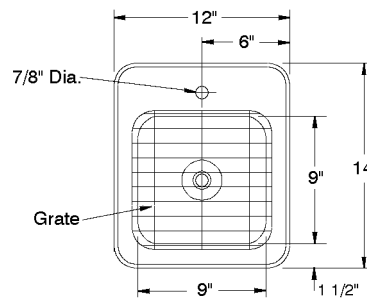

Cut-Out Size
11 1/4" x 13 1/4"
1 1/4" radius corners

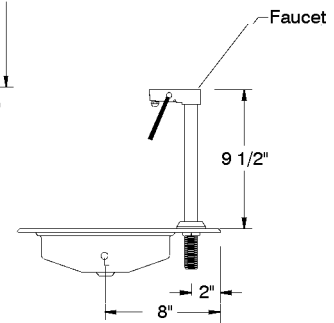
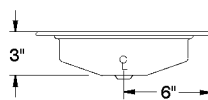

Approx. Wt. 15 lbs.

Supplied with K-54 Faucet

