

88 5051 501

St. Ives

Queen Headboard

IMPORTANT NOTE

Carefully remove all the parts from the carton and put them individually on a soft cloth to prevent scratches or other damages occurring to the wood parts.

We have taken great care in the design of this product and request that you carefully and strictly follow our assembly instructions to ensure a completed product as it was designed.

Home Styles



Part List



A.
Metal Frame
1 pc.

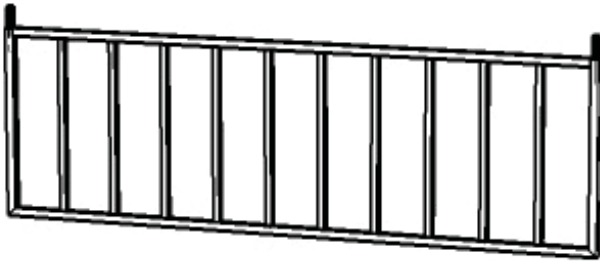

B.
Metal Frame
1 pc.

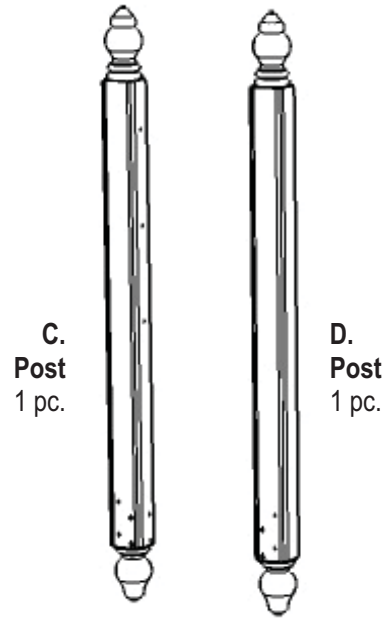

C.
Post
1 pc.

D.
Post
1 pc.

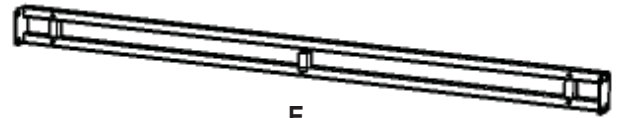

E.
Stretcher
1 pc.

Hardware List



Small Hex Wrench
1 pc.



Hex Wrench
1 pc.



Head Cap Bolt (short)
4 pcs. (+1 extra)



Head Cap Bolt (middle)
8 pcs. (+1 extra)

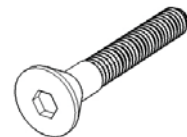

Head Cap Bolt (long)
6 pcs. (+1 extra)

Assembly Instructions

IMPORTANT

- * Do not tighten up all the screws until each part is properly assembled.
- * You should keep Hex Wrench in a safe place as you may need to tighten up the Head Cap Bolts in the future.
- * Use a soft cloth between these parts and the floor.

STEP 1

Attach Metal Frame (A) to Metal Frame (B) with Head Cap Bolts (middle).

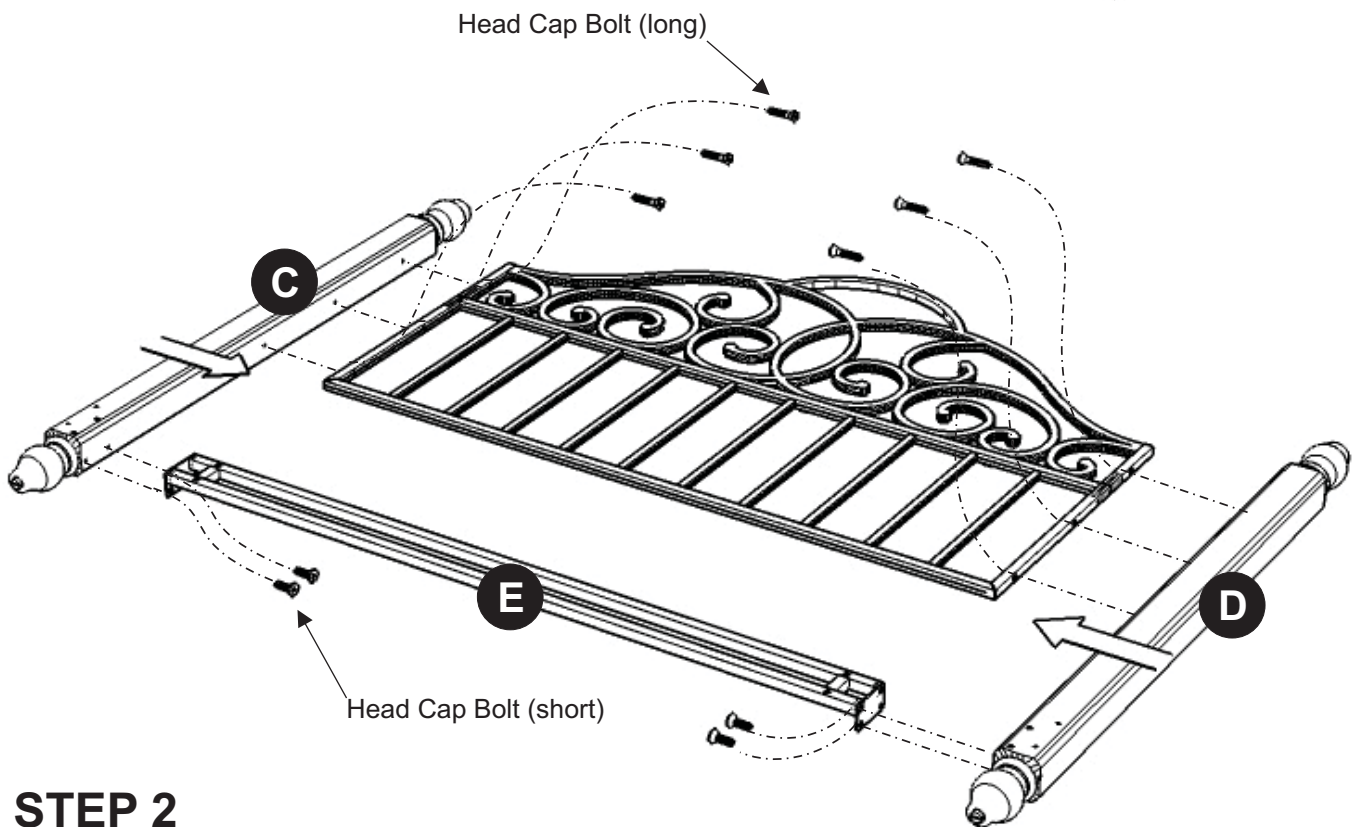
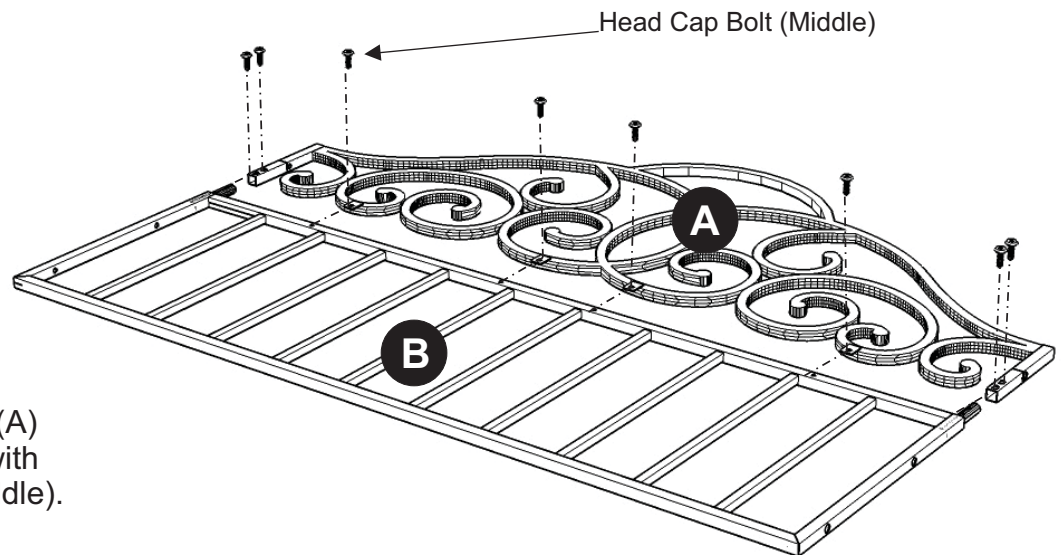

STEP 2

Attach Post (C) and Stretcher (E) to unit with Head Cap Bolts (long) and Head Cap Bolts (short).

Attach Post (D) to unit with Head Cap Bolts (long) and Head Cap Bolts (short).

88 5051 502

St. Ives

Queen Footboard

IMPORTANT NOTE

Carefully remove all the parts from the carton and put them individually on a soft cloth to prevent scratches or other damages occurring to the wood parts.

We have taken great care in the design of this product and request that you carefully and strictly follow our assembly instructions to ensure a completed product as it was designed.

*Home
Styles*

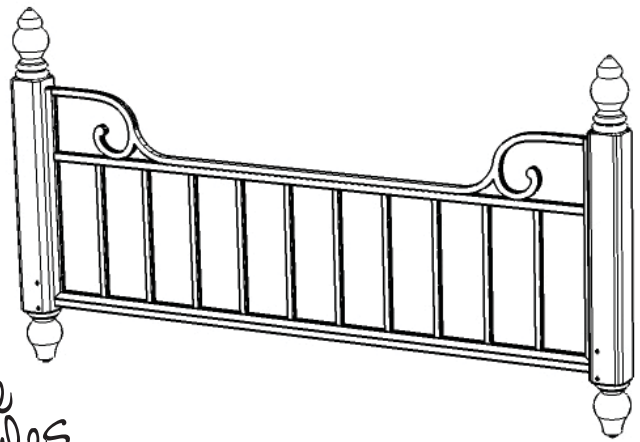

Part List

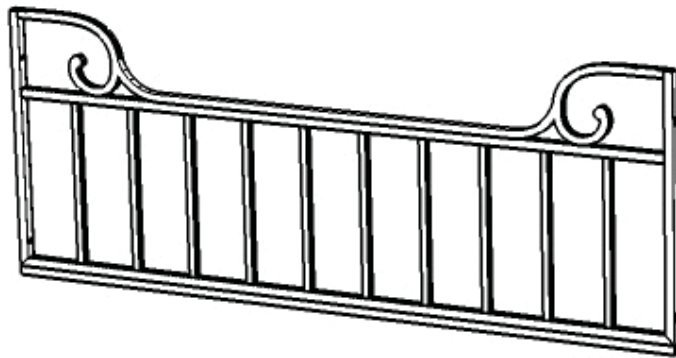

F.
Metal Frame
1 pc.



G.
Post
1 pc.



H.
Post
1 pc.

Hardware List

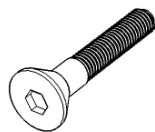

Head Cap Bolt
4 pcs. (+1 extra)

For assembly see instructions in carton 88 5051 503

Home Styles Consumer Assistance: www.homestyles-furniture.com,
servicedesk@homestyles-furniture.com, 888-680-7460, 877-831-0319

Assembly Instructions

IMPORTANT

- * Do not tighten up all the screws until each part is properly assembled.
- * You should keep Hex Wrench in a safe place as you may need to tighten up the Head Cap Bolts in the future.
- * Use a soft cloth between these parts and the floor.

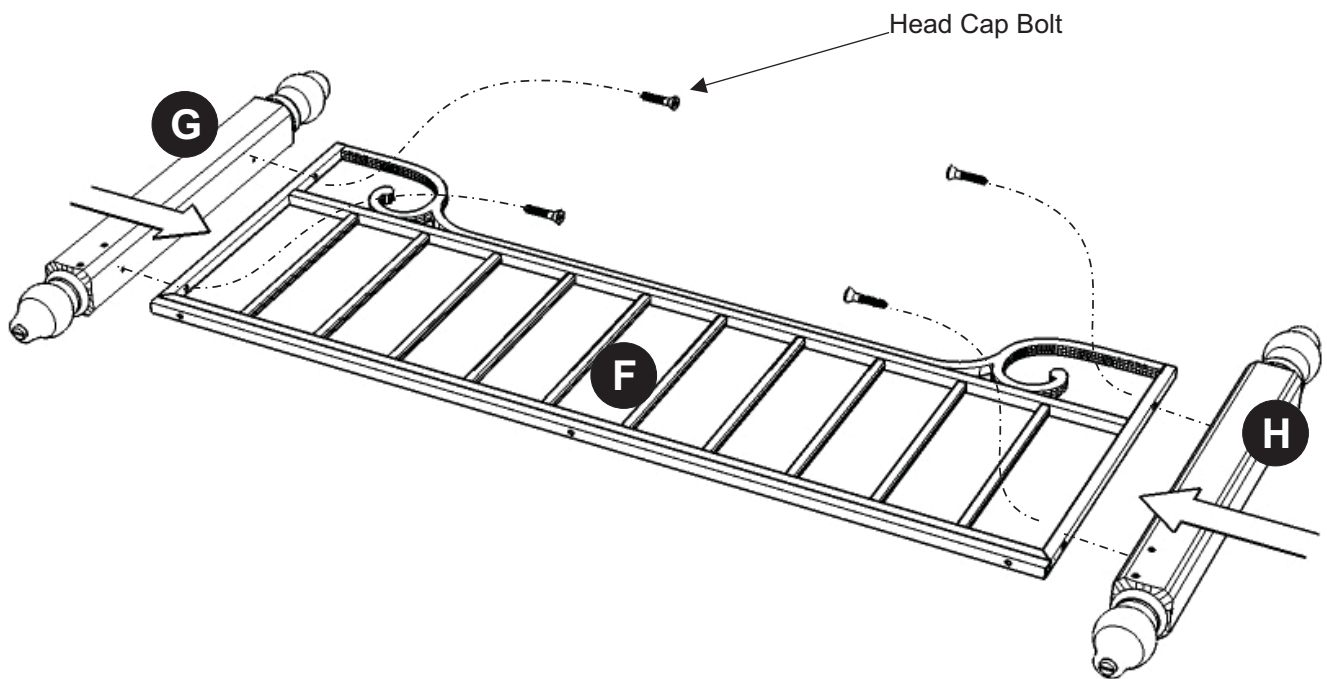

STEP 1

Attach Post (G) and (H) to Metal Frame (F) with Head Cap Bolts.

88 5051 503

St. Ives

Queen Bed Rails

IMPORTANT NOTE

Carefully remove all the parts from the carton and put them individually on a soft cloth to prevent scratches or other damages occurring to the wood parts.

We have taken great care in the design of this product and request that you carefully and strictly follow our assembly instructions to ensure a completed product as it was designed.

Home Styles



Part List

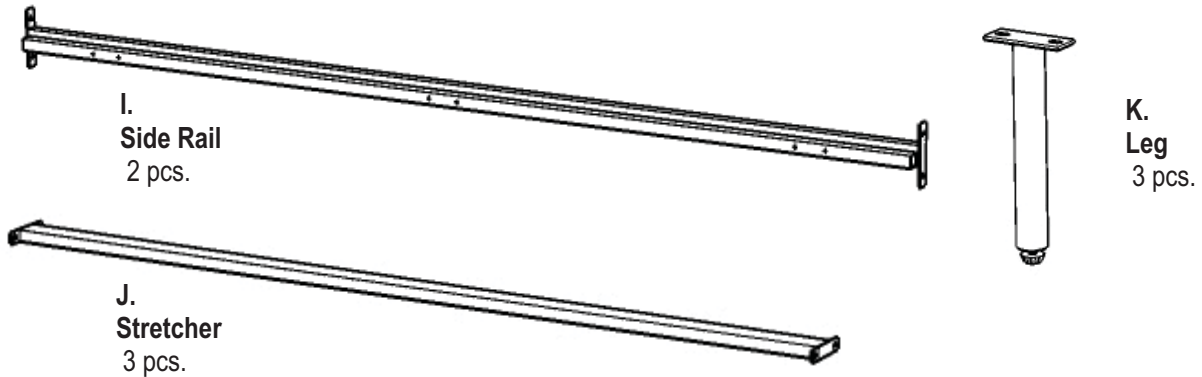

Hardware List

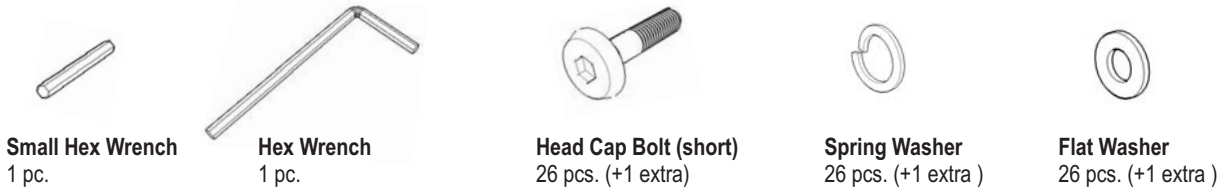

For assembly also need the following:

88 5051 501

Carton quantity: 1



88 5051 502

Carton quantity: 1

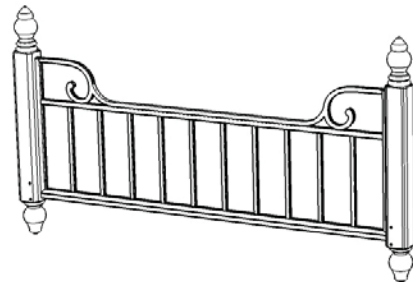

Tools recommended for assembly : Level

Home Styles Consumer Assistance: www.homestyles-furniture.com,
servicedesk@homestyles-furniture.com, 888-680-7460, 877-831-0319

Assembly Instructions

IMPORTANT

- * Do not tighten up all the screws until each part is properly assembled.
- * You should keep Hex Wrench in a safe place as you may need to tighten up the Head Cap Bolts in the future.
- * Use a soft cloth between these parts and the floor.
- * After assembly, item must be level to work properly.
Use the included adjustable levelers to level.

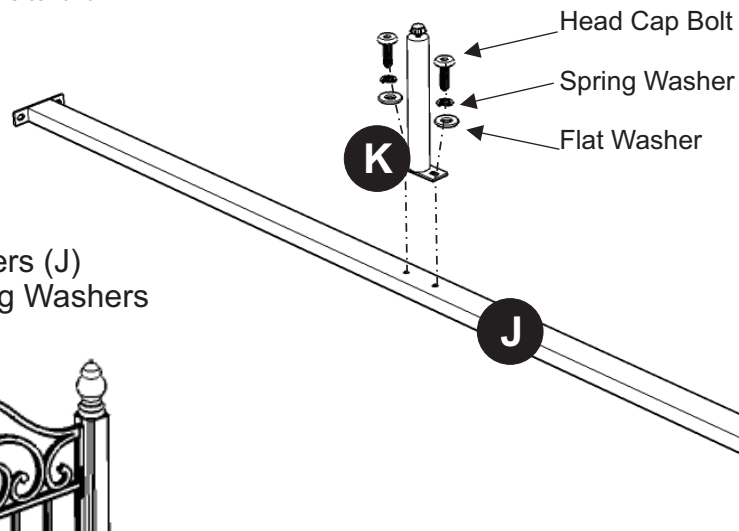

STEP 1

Attach Legs (K) to Stretchers (J) with Head Cap Bolts Spring Washers and Flat Washers.

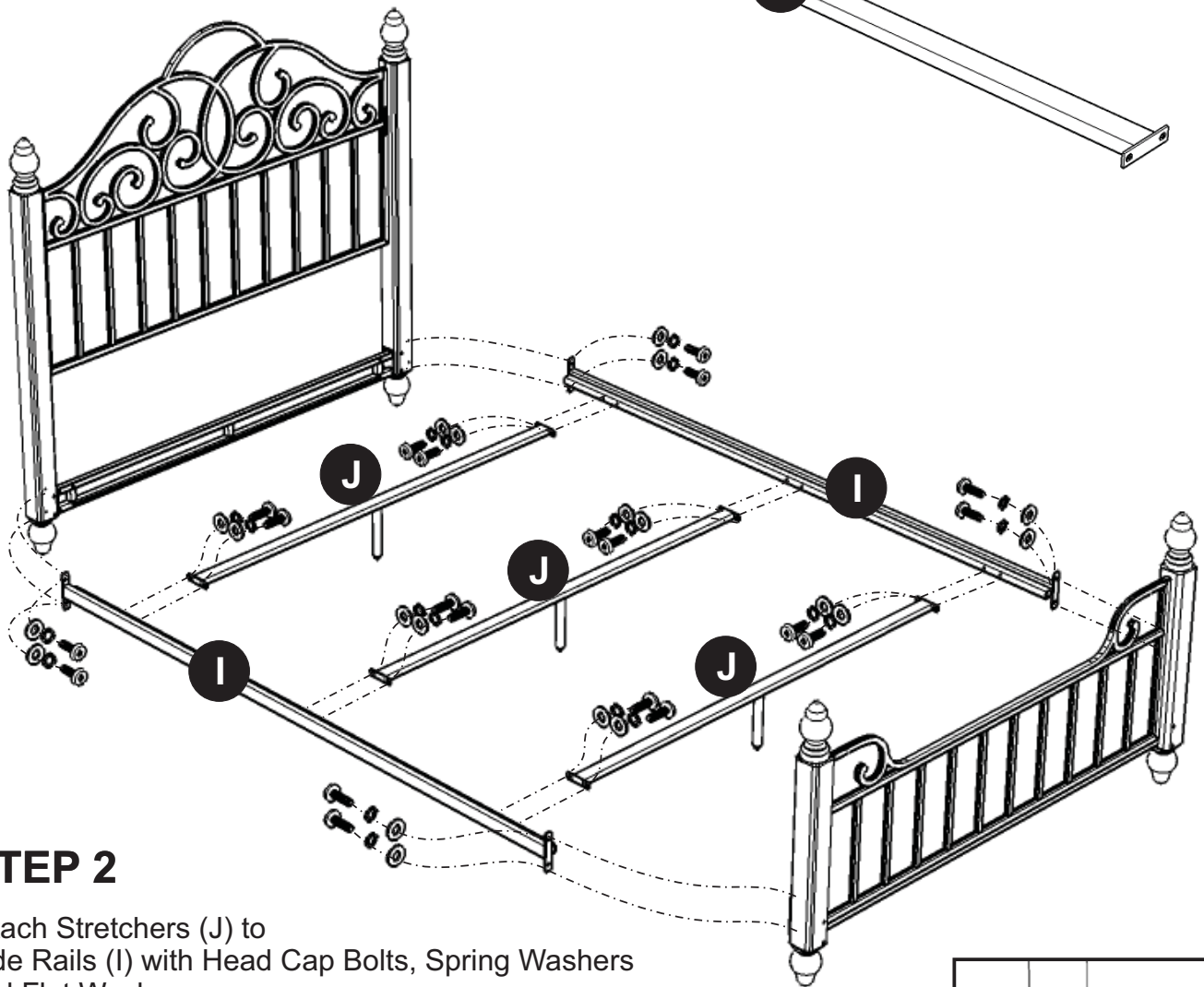

STEP 2

Attach Stretchers (J) to Side Rails (I) with Head Cap Bolts, Spring Washers and Flat Washers.

Attach Headboard and Footboard to unit with Head Cap Bolts, Spring Washers and Flat Washers.

To level the unit, adjust the adjustable levelers on the bottom of legs.
(See figure 1)

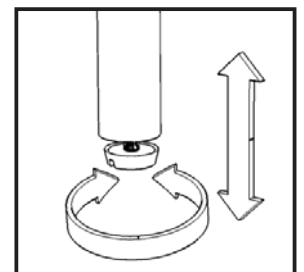

Figure 1