

88 5052 13 Bordeaux Media Tower

IMPORTANT NOTE

Carefully remove all the parts from the carton and put them individually on a soft cloth to prevent scratches or other damages occurring to the parts.

We have taken great care in the design of this product and request that you carefully and strictly follow our assembly instructions to ensure a completed product as it was designed.

Home Styles

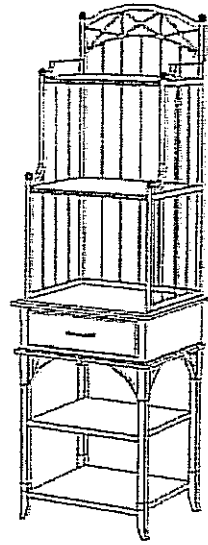

Part List

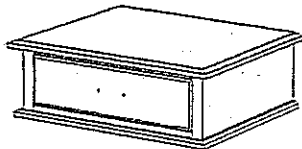

A.
Cabinet
1 pc.

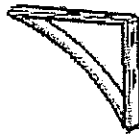

B.
Support Leg
4 pcs.

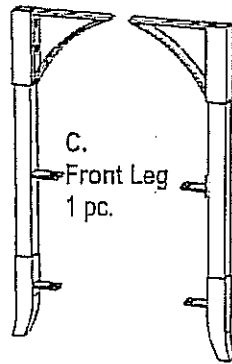

C.
Front Leg
1 pc.

D.
Front Leg
1 pc.



E.
Back Leg
1 pc.



F.
Back Leg
1 pc.



G.
Shelf
2 pcs.

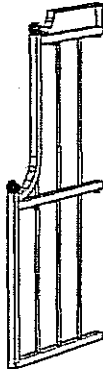

H.
Side Frame
1 pc.

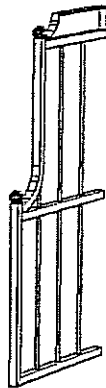

I.
Side Frame
1 pc.



J.
Back Frame
1 pc.

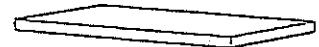

K.
Shelf
1 pc.

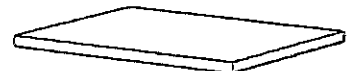

L.
Shelf
1 pc.

Hardware List

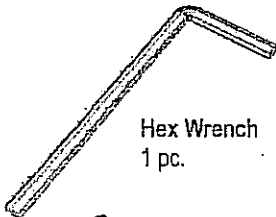

Hex Wrench
1 pc.



Head Cap Bolt
22 pcs. (+1 extra)



Spring Washer
22 pcs. (+1 extra)



Wood Screw
12 pcs. (+1 extra)



Wood Screw
1 pc. (+1 extra)

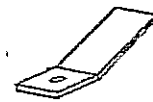

Drawer Stop
1 pc. (+1 extra)



Small
Hex Wrench
1 pc.



Flat Washer
22 pcs. (+1 extra)



Tapered
Head Cap Bolt
6 pcs. (+1 extra)



Tapered
Head Cap Bolt (short)
10 pcs. (+1 extra)

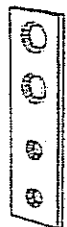

Steel Plate Connector
2 pcs. (+1 extra)

Tools required for assembly : Phillips screwdriver

Tools recommended for assembly : Level

Home Styles Consumer Assistance Line 888-680-7460 and 877-831-0319
servicedesk@homestyles-furniture.com

STEP 4

Attach Shelves (G) to unit with Tapered Head Cap Bolts (short).

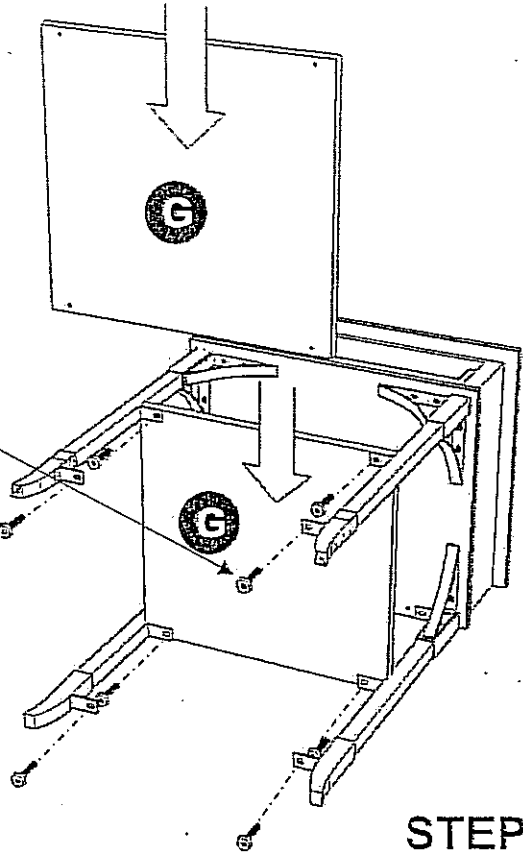
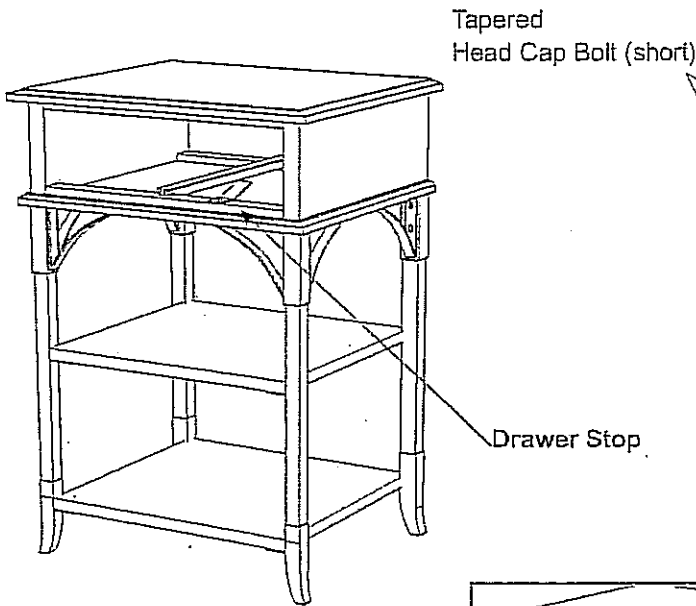

STEP 5

Turn unit to it's upright position.

Attach Drawer Stop with Wood Screw into the pre-drilled hole inside the opening of the unit. (see Figure 2)

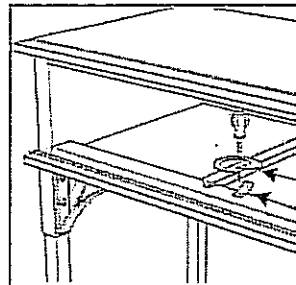

Wood Screw
Drawer Stop

Figure 2

STEP 6

Remove the Pull Handle that is installed on the inside of the drawer and re-install it on the outside of the drawer. (See figure 3)

Slide the drawer into position.

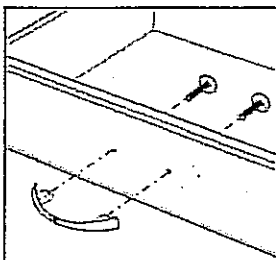

Figure 3



VERY IMPORTANT !!

CARE INSTRUCTIONS

NEVER

USE GLASS CLEANERS ON FINISHED FURNITURE. AMMONIA WILL CHEMICALLY ATTACK THE LACQUER.

NEVER

ALLOW LIQUIDS OF ANY KIND TO REMAIN ON THE FURNITURE. ABSORPTION CAUSES WOOD TO WARP AND SPLIT AND FINISHES TO DELAMINATE.

DO NOT WRITE DIRECTLY ON SURFACE.



PREVENT MARKING

DO NOT PLACE IN DIRECT SUNLIGHT.



PREVENT FADING

DO NOT USE COMMERCIAL WAXES AND POLISHES.



PREVENT YELLOWING

DO NOT PLACE HOT OBJECTS ON SURFACE.



PREVENT FINISH DAMAGE

DO NOT USE RUBBER BASED PLACE MATS.

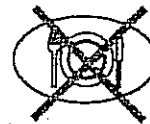

PREVENT DISCOLORING

TO CLEAN

USE A SOFT CLOTH MOISTENED IN LEMON OIL POLISH OR LUKEWARM SOAP AND WATER, THEN BUFF WITH A DRY CLEAN CLOTH.

