

88 5180 164

Arts & Crafts

Student Desk Hutch

IMPORTANT NOTE

Carefully remove all the parts from the carton and put them individually on a soft cloth to prevent scratches or other damages occurring to the parts.

We have taken great care in the design of this product and request that you carefully and strictly follow our assembly instructions to ensure a completed product as it was designed.

*Home
Styles*



PART LIST

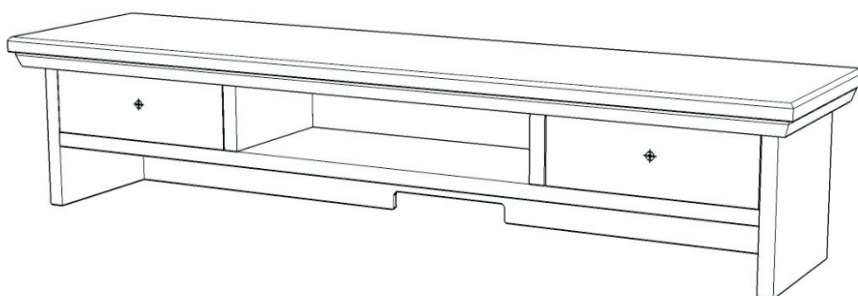

Assembly Instructions

STEP 1

Remove the Pull Handles that are installed on the inside of the drawers and re-install them on the outside of the drawer. (See figure 1)

Slide the drawers into position.

Place Hutch on the Student Desk.

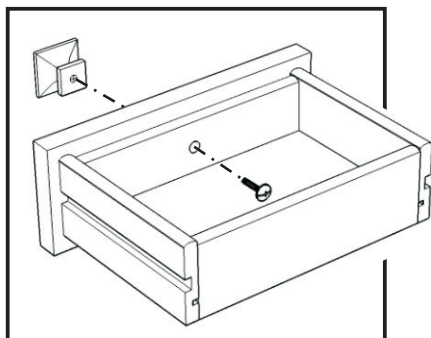

(Figure 1)

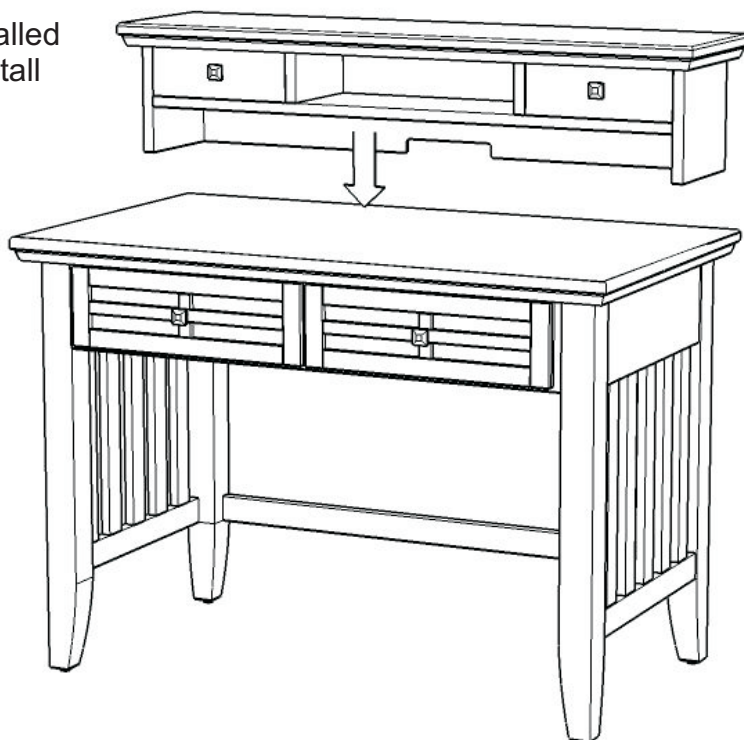

Tools Required For Assembly : Phillips screwdriver

Home Styles Consumer Assistance Line 888-680-7460 and 877-831-0319
servicedesk@homestyles-furniture.com