

88 5180 15

Arts & Crafts Executive Desk

IMPORTANT NOTE

Carefully remove all the parts from the carton and put them individually on a soft cloth to prevent scratches or other damages occurring to the parts.

We have taken great care in the design of this product and request that you carefully and strictly follow our assembly instructions to ensure a completed product as it was designed.

Home Styles

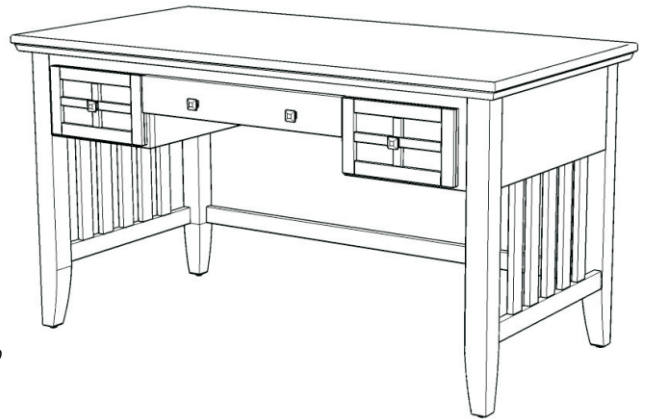

PART LIST

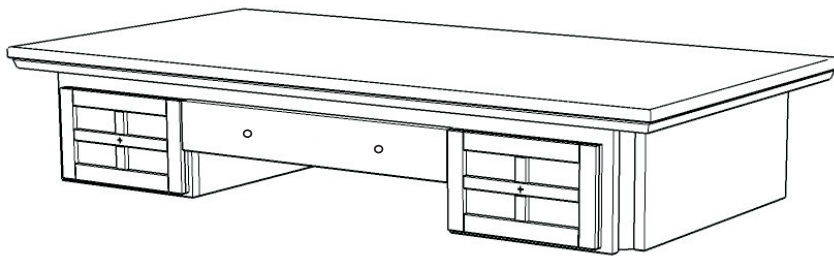

A.
Top Unit
1 pc.

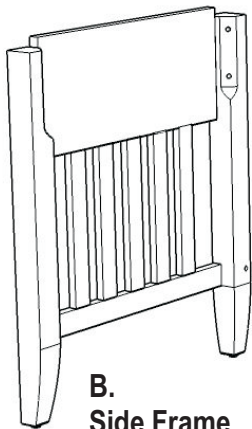

B.
Side Frame
1 pc.

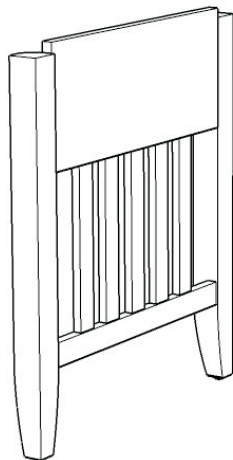

C.
Side Frame
1 pc.



D.
Stretcher
1 pc.

HARDWARE LIST



Key Wrench
1 pc.



Spring Washer
8 pcs. (+1 extra)



Flat Washer
8 pcs. (+1 extra)

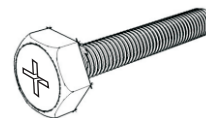

Bolt
8 pcs. (+1 extra)



Wood Screw
2 pcs. (+1 extra)

Tools required for assembly : **Phillips** screwdriver

Tools recommended for assembly : Level

Home Styles Consumer Assistance Line 888-680-7460 and 877-831-0319
servicedesk@homestyles-furniture.com

Assembly Instructions

IMPORTANT

- * Use a soft cloth between these parts and the floor.
- * Do not tighten up all the screws until each part is properly assembled.
- * You should keep Key Wrench in a safe place as you may need to tighten up the Bolts in the future.
- * After assembly, item must be level to work properly. Use the included adjustable levelers to level.

STEP 1

Turn the Top (A) upside down and place it on a soft cloth.

Remove all the drawers.

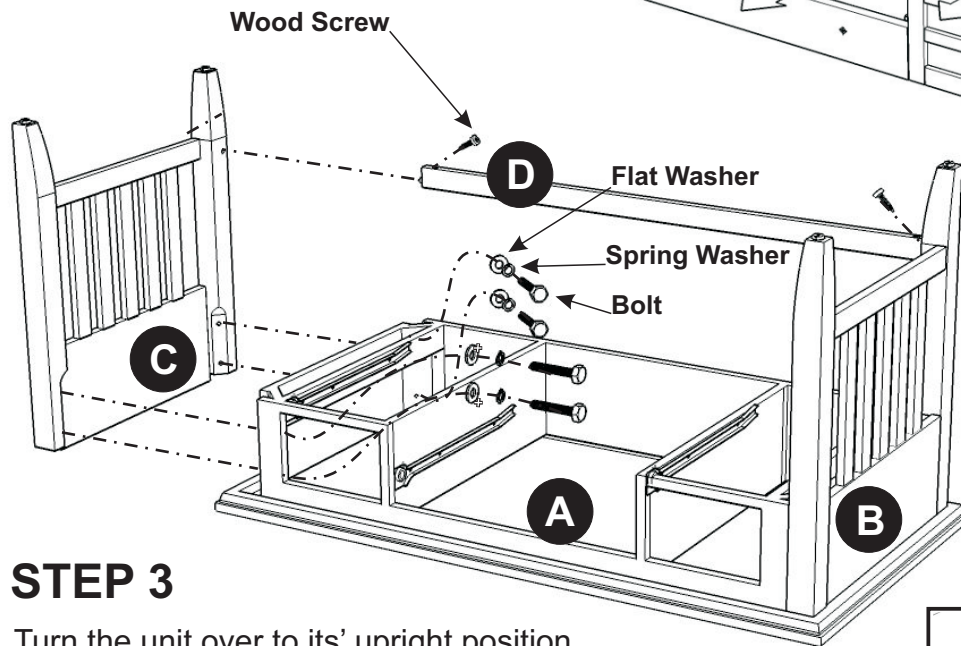
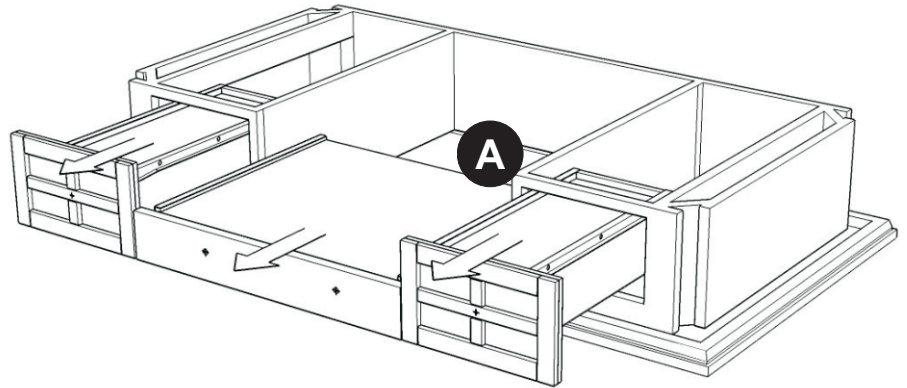

STEP 2

Attach Side Frame (B) and (C) to Top (A) with Flat Washers, Spring Washers and Bolts. Tighten only half way. (See figure 1)

Attach Stretcher (D) to the unit with Wood Screws.

Tighten all bolts.

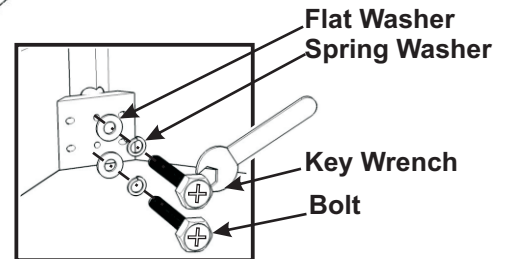

(Figure 1)

STEP 3

Turn the unit over to its' upright position.

Remove the Pull Handles that are installed on the inside of the drawers and re-install them on the outside of the drawer. (See figure 2)

Slide the drawers into position.

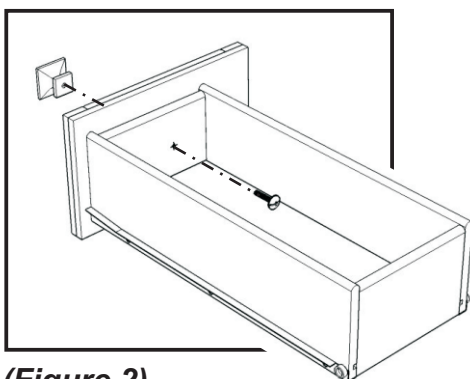

(Figure 2)

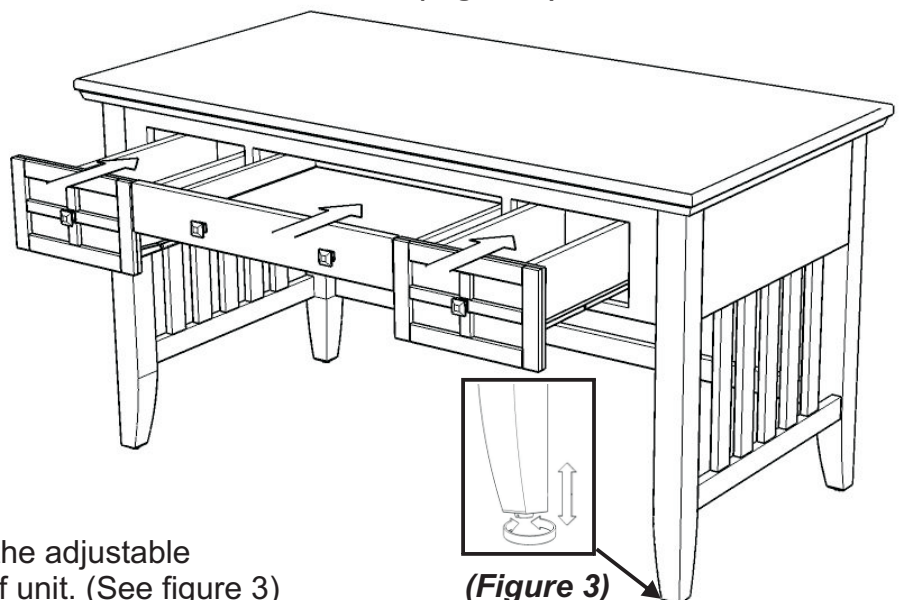

(Figure 3)

STEP 4

To level the unit, adjust the adjustable levelers on the bottom of unit. (See figure 3)