

88 5100 201 Buffet and Hutch (Natural Finish)

IMPORTANT NOTE

Carefully remove all the parts from the carton and put them individually on a soft cloth to prevent scratches or other damages occurring to the wood parts.

We have taken great care in the design of this product and request that you carefully and strictly follow our assembly instructions to ensure a completed product as it was designed.

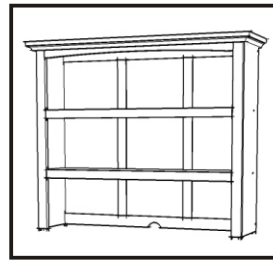

Hutch Unit



Thai Patent Pending Numbers 0602000975



Casual Attire For Today's Home

Hutch Unit Part List

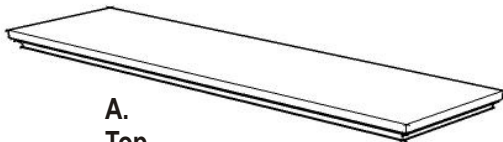

A.
Top
1 pc.



F.
Back Stretcher
1 pc.



G.
Back Stretcher
1 pc.

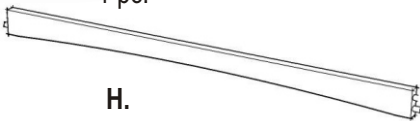

H.
Front Piece
1 pc.



B.
Side Panel
1 pc.

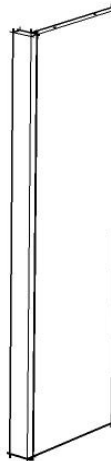

C.
Side Panel
1 pc.

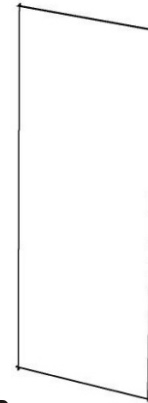

D.
Back Panel
3 pcs.



E.
Back Piece
2 pcs.

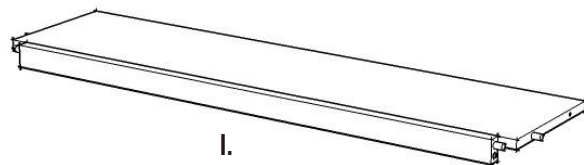

I.
Shelf
2 pcs.

Hardware List



Cam Lock Screw
18 pcs. (+1 extra)



Cam Lock
18 pcs. (+1 extra)



**Wood Screw
for Back Panel**
12 pcs. (1 extra)



**Wood Screw
for Steel Plate
Connector**
8 pcs. (1 extra)



**Steel Plate
Connector**
2 pcs.

Tools required for assembly: Philips screwdriver

88 5100 202 Buffet and Hutch (White Finish)

IMPORTANT NOTE

Carefully remove all the parts from the carton and put them individually on a soft cloth to prevent scratches or other damages occurring to the wood parts.

We have taken great care in the design of this product and request that you carefully and strictly follow our assembly instructions to ensure a completed product as it was designed.

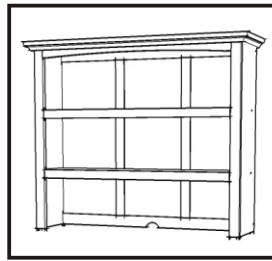

Hutch Unit



Thai Patent Pending Numbers 0602000975



Casual Attire For Today's Home

Hutch Unit Part List

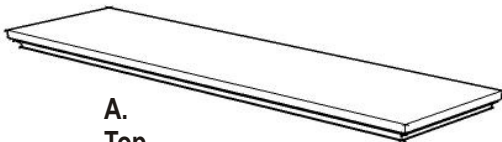

A.
Top
1 pc.



F.
Back Stretcher
1 pc.



G.
Back Stretcher
1 pc.



H.
Front Piece
1 pc.



B.
Side Panel
1 pc.

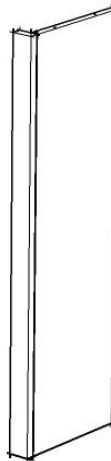

C.
Side Panel
1 pc.

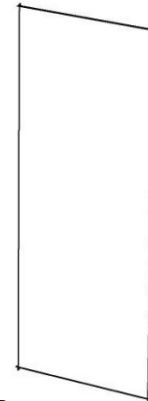

D.
Back Panel
3 pcs.



E.
Back Piece
2 pcs.

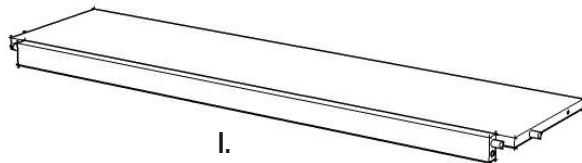

I.
Shelf
2 pcs.

Hardware List



Cam Lock Screw
18 pcs. (+1 extra)



Cam Lock
18 pcs. (+1 extra)



**Wood Screw
for Back Panel**
12 pcs. (1 extra)



**Wood Screw
for Steel Plate
Connector**
8 pcs. (1 extra)



**Steel Plate
Connector**
2 pcs.

Tools required for assembly: Philips screwdriver

88 5100 203 Buffet and Hutch (Red Finish)

IMPORTANT NOTE

Carefully remove all the parts from the carton and put them individually on a soft cloth to prevent scratches or other damages occurring to the wood parts.

We have taken great care in the design of this product and request that you carefully and strictly follow our assembly instructions to ensure a completed product as it was designed.



Hutch Unit

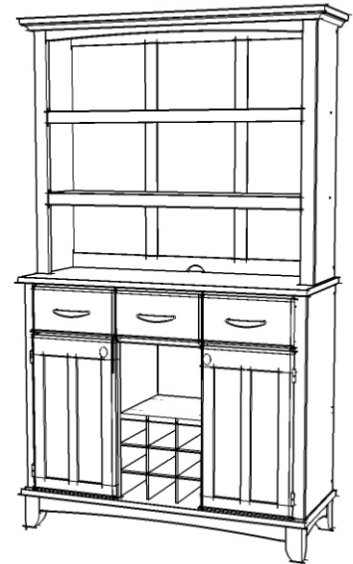

Thai Patent Pending Numbers 0602000975



Casual Attire For Today's Home

Hutch Unit Part List

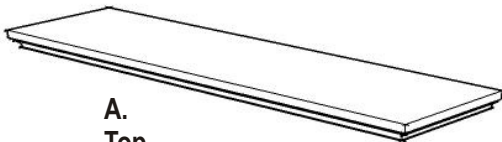

A.
Top
1 pc.



F.
Back Stretcher
1 pc.



G.
Back Stretcher
1 pc.



H.
Front Piece
1 pc.

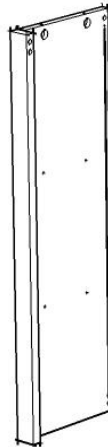

B.
Side Panel
1 pc.

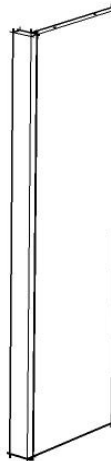

C.
Side Panel
1 pc.

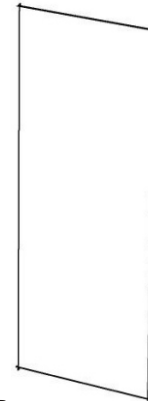

D.
Back Panel
3 pcs.



E.
Back Piece
2 pcs.

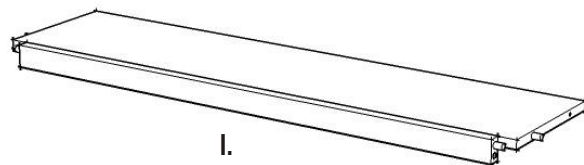

I.
Shelf
2 pcs.

Hardware List



Cam Lock Screw
18 pcs. (+1 extra)



Cam Lock
18 pcs. (+1 extra)



Wood Screw for Back Panel
12 pcs. (1 extra)



Wood Screw for Steel Plate Connector
8 pcs. (1 extra)



Steel Plate Connector
2 pcs.

Tools required for assembly: Philips screwdriver

88 5100 204 Buffet and Hutch (Black Finish)

IMPORTANT NOTE

Carefully remove all the parts from the carton and put them individually on a soft cloth to prevent scratches or other damages occurring to the wood parts.

We have taken great care in the design of this product and request that you carefully and strictly follow our assembly instructions to ensure a completed product as it was designed.



Hutch Unit



Thai Patent Pending Numbers 0602000975



Casual Attire For Today's Home

Hutch Unit Part List

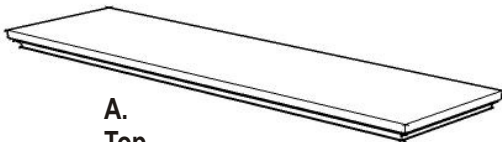

A.
Top
1 pc.



F.
Back Stretcher
1 pc.



G.
Back Stretcher
1 pc.

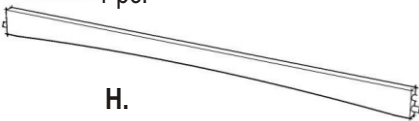

H.
Front Piece
1 pc.



B.
Side Panel
1 pc.

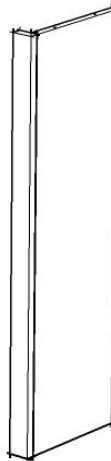

C.
Side Panel
1 pc.

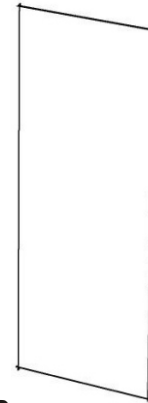

D.
Back Panel
3 pcs.



E.
Back Piece
2 pcs.

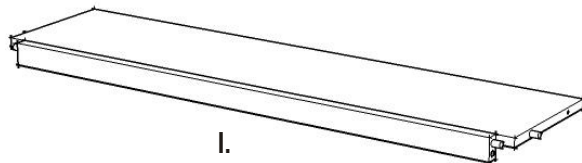

I.
Shelf
2 pcs.

Hardware List



Cam Lock Screw
18 pcs. (+1 extra)



Cam Lock
18 pcs. (+1 extra)



Wood Screw
for Back Panel
12 pcs. (1 extra)



Wood Screw
for Steel Plate
Connector
8 pcs. (1 extra)



Steel Plate
Connector
2 pcs.

Tools required for assembly: Philips screwdriver

88 5100 206 Buffet and Hutch (Cottage Oak)

IMPORTANT NOTE

Carefully remove all the parts from the carton and put them individually on a soft cloth to prevent scratches or other damages occurring to the wood parts.

We have taken great care in the design of this product and request that you carefully and strictly follow our assembly instructions to ensure a completed product as it was designed.

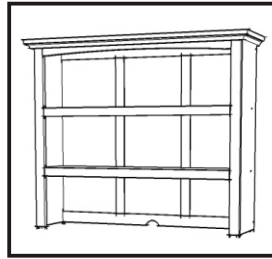

Hutch Unit



Thai Patent Pending Numbers 0602000975



Casual Attire For Today's Home

Hutch Unit Part List

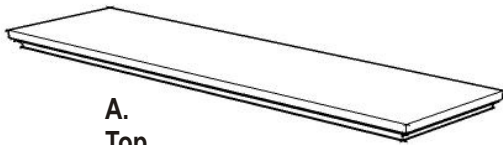

A.
Top
1 pc.



F.
Back Stretcher
1 pc.



G.
Back Stretcher
1 pc.



H.
Front Piece
1 pc.



B.
Side Panel
1 pc.

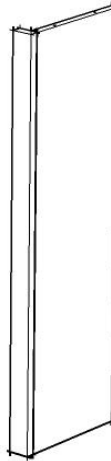

C.
Side Panel
1 pc.



D.
Back Panel
3 pcs.



E.
Back Piece
2 pcs.

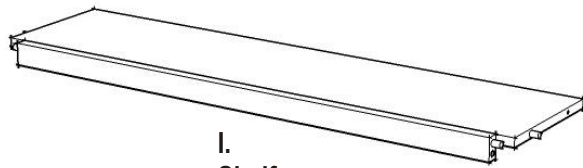

I.
Shelf
2 pcs.

Hardware List



Cam Lock Screw
18 pcs. (+1 extra)



Cam Lock
18 pcs. (+1 extra)



Wood Screw for Back Panel
12 pcs. (1 extra)



Wood Screw for Steel Plate Connector
8 pcs. (1 extra)



Steel Plate Connector
2 pcs.

Tools required for assembly: Philips screwdriver

88 5100 207 Buffet and Hutch (Cherry Finish)

IMPORTANT NOTE

Carefully remove all the parts from the carton and put them individually on a soft cloth to prevent scratches or other damages occurring to the wood parts.

We have taken great care in the design of this product and request that you carefully and strictly follow our assembly instructions to ensure a completed product as it was designed.

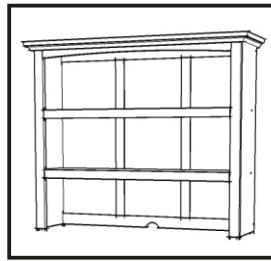

Hutch Unit



Thai Patent Pending Numbers 0602000975



Casual Attire For Today's Home

Hutch Unit Part List

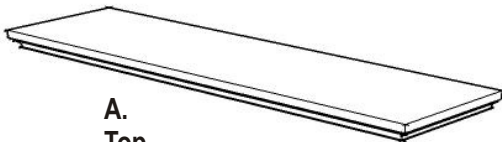

A.
Top
1 pc.



F.
Back Stretcher
1 pc.



G.
Back Stretcher
1 pc.



H.
Front Piece
1 pc.



B.
Side Panel
1 pc.

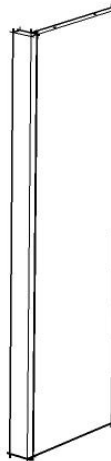

C.
Side Panel
1 pc.

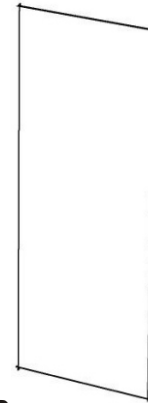

D.
Back Panel
3 pcs.



E.
Back Piece
2 pcs.

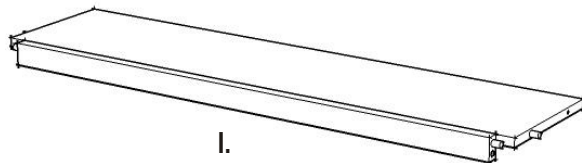

I.
Shelf
2 pcs.

Hardware List



Cam Lock Screw
18 pcs. (+1 extra)



Cam Lock
18 pcs. (+1 extra)



Wood Screw for Back Panel
12 pcs. (1 extra)



Wood Screw for Steel Plate Connector
8 pcs. (1 extra)



Steel Plate Connector
2 pcs.

Tools required for assembly: Philips screwdriver

Assembly Instructions 2/3

IMPORTANT

Do not tighten up all the screws until each part is properly assembled.

You should keep Hex Wrench in the safe place as you may need to tighten up the Head Cap Bolts in the future.

STEP 1

Put Cam Lock Screws into the pre-drilled holes of Side Panel (B) and (C), and tighten up.

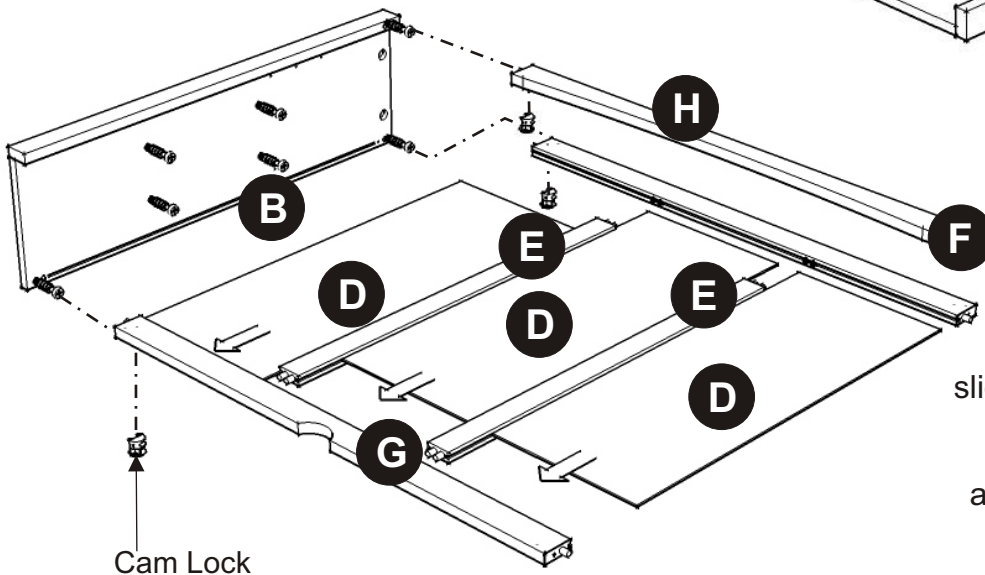
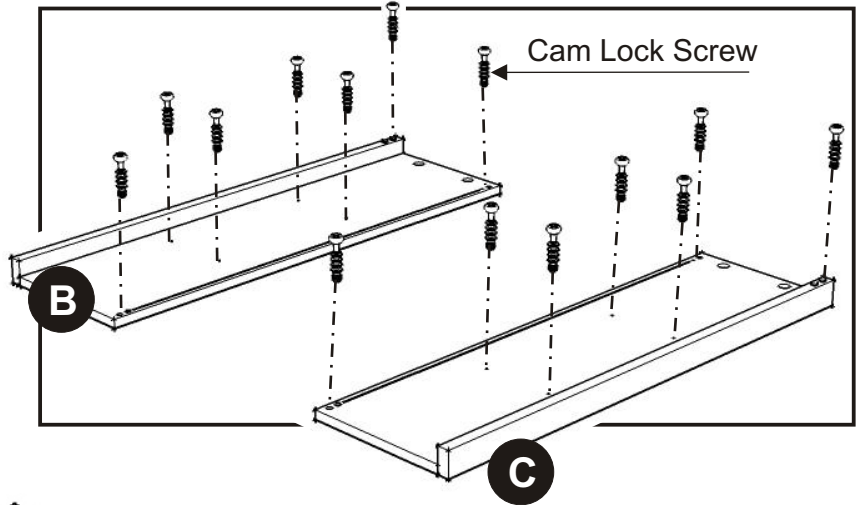

STEP 2

Attach Back Stretcher (G) to Side Panel (B) with Cam Lock.

Attach Back Piece (E) to Back Stretcher (G) and slide Back Panel (D) into place.

Attach Back Stretcher (F) and Front Piece (H) to the unit with Cam Locks.

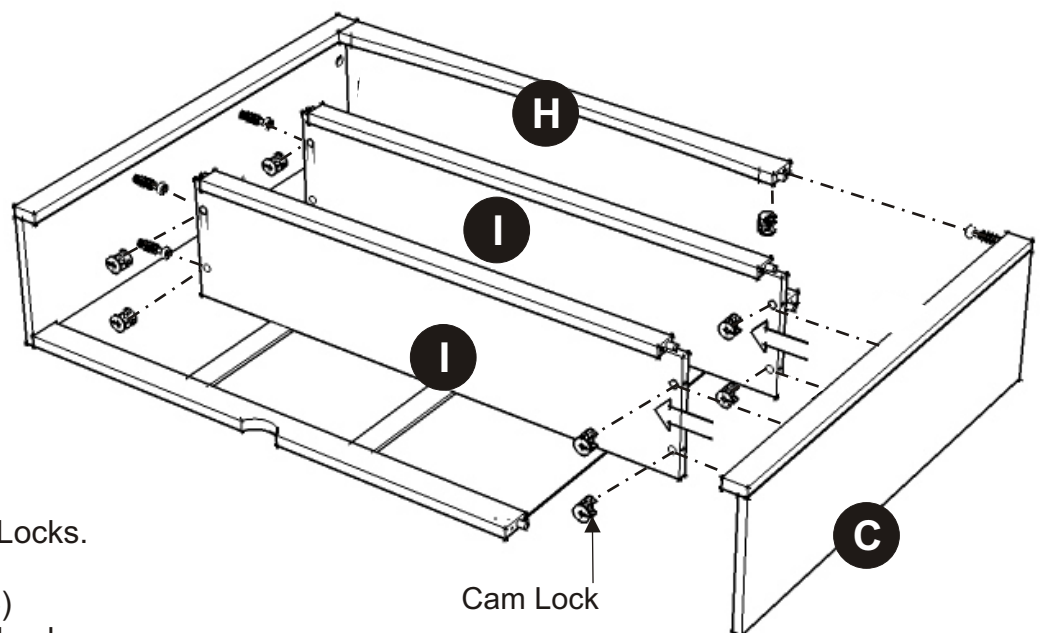

STEP 3

Attach Shelf (I) to the unit with Cam Locks.

Attach Side Panel (C) to the unit with Cam Locks.

Assembly Instructions 3/3

STEP 4

Put the Cam Lock Screw into the pre-drilled holes at Top (A).

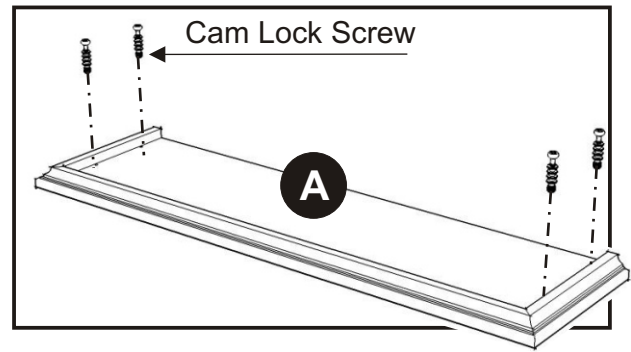
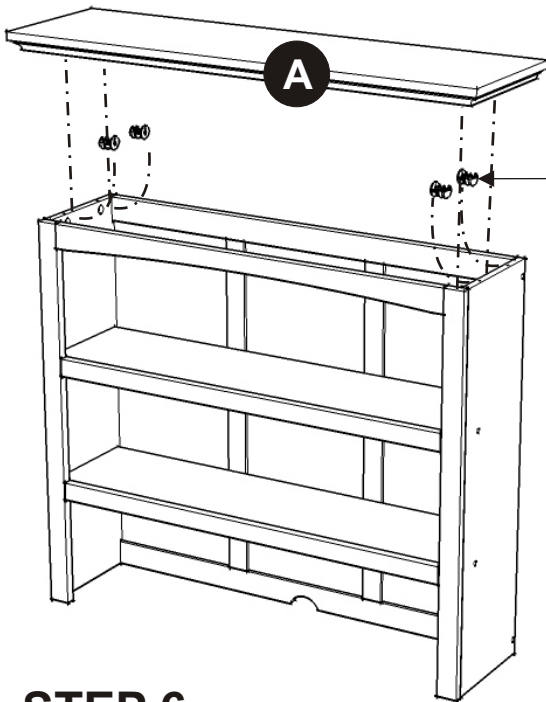

Cam Lock

STEP 5

Turn the unit back to its normal position.

Place Top (A) onto the unit, using Cam Locks.

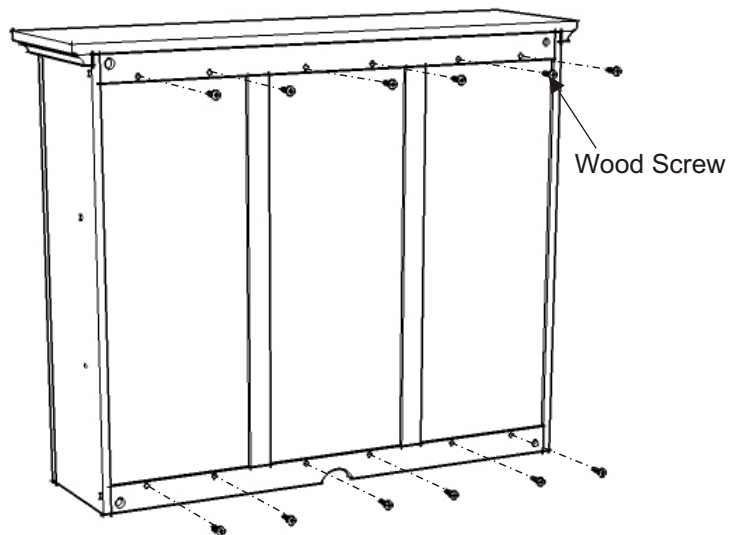

STEP 6

Insert Wood Screws from the back and tighten up.

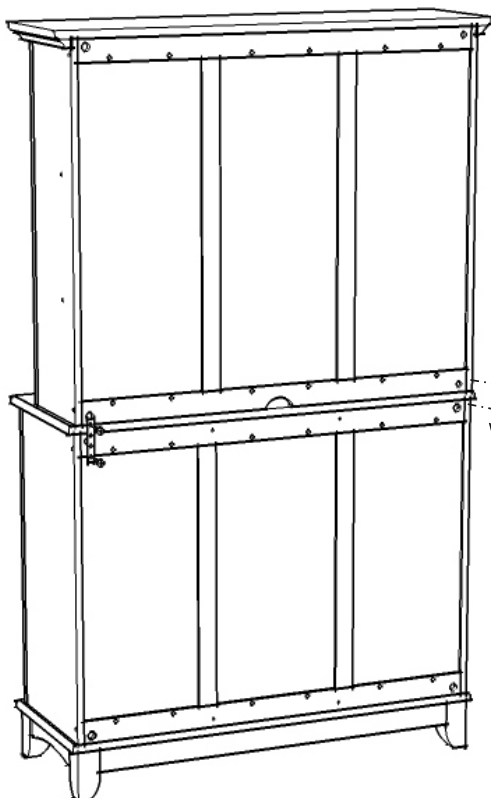

Steel Plate Connector

Wood Screw

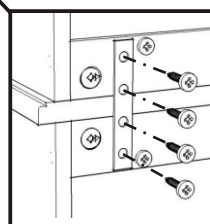

(Figure 1)

STEP 7

Place the Hutch unit onto the Buffet unit.

To hold firmly the Hutch and Buffet, attach Steel Plate Connectors, insert Wood Screws and tighten up. (See figure 1)

Attention !

For safety reasons, we recommended you strictly follow this additional instructions as to prevent this Buffet & Hutch Unit from tipping over.

HARDWARE LIST

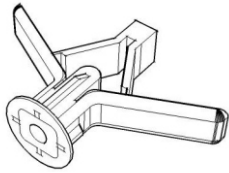

Anchor (A)
2 pcs.(+1 extra)



Anchor (B)
2 pcs.(+1 extra)

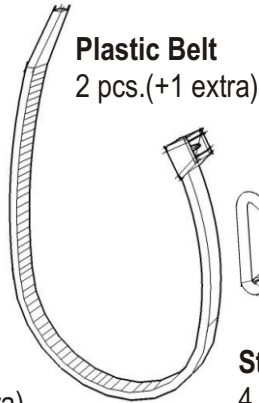

Plastic Belt
2 pcs.(+1 extra)

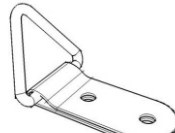

Steel Bracket
4 pcs.(+1 extra)

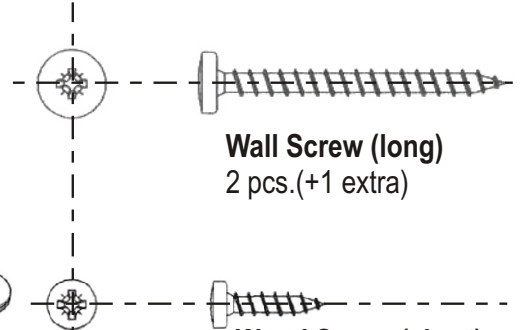

Wall Screw (long)
2 pcs.(+1 extra)

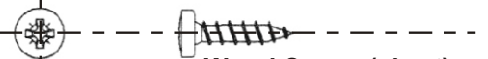

Wood Screw (short)
2 pcs.(+1 extra)

Assembly Instructions

Place the Buffet & Hutch unit at the wall.

(Please note that the Anchor (A) is for hollow wall and Anchor (B) is for concrete wall.)

Use the electric drill at the drilling positions on the wall. Insert the selected Anchors into the wall holes and put the Steel Brackets on. Put in wall screws and tighten up.

Put Steel Brackets at the pre-drilled holes on the top of the unit. Put in wood screws and tighten up.

Use the Plastic Belt to secure the Steel Brackets at the unit and the Steel Brackets at the wall (See figure 12). Put the belt end into its socket and tie up.

