

AVA CONSOLE TABLE
MESA DE VESTÍBULO AVA

Product Dimensions / Dimensiones del producto:
43.875 in W 20in D x 31.375 in H (111.44 cm 50.8 cm x79.69 cm)

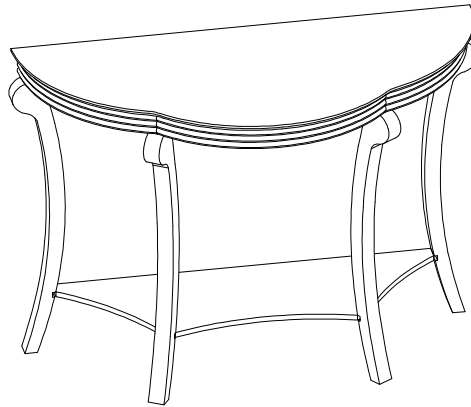

ENGLISH

- * Please make sure that you have all parts indicated before you begin assembly of this item
- * This item should be assembled on a soft surface to prevent scratching the finish during assembly
- * This item may require periodic tightening. We recommend every 6 months.
- * Requires Phillips head screw driver for assembly.









Caution: Recommended weight limit is 40 lbs or less.

ESPAÑOL

- * Compruebe que están presentes todas las piezas antes de comenzar a montar este producto
- * Este producto se debe montar sobre una superficie suave para evitar que se pudiera arañar durante el proceso de montaje
- * La tornillería de este producto precisa ser apretada periódicamente, preferentemente una vez cada 6 meses.
- * Requiere destornillador Phillips para el ensamblaje.

Precaución: El límite de peso recomendado es de 20 kilos o menos.

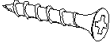
Part list / Lista de piezas
Hardware List/Lista de tornillería

A	Table top/ Tablero		1x
B	Bottom shelf /Estante inferior		1x
C	Leg/Pata		4x
H1	Allen bolt/ Tornillo allen		8x
H2	Spring washer/ Tuerca con resorte		8x
H3	Flat washer/ Arandela plana		8x
H4	Allen wrench/ Llave allen		1x
H5	Screw / Tornillo		4x
H6	Leveler/Nivelador		4x



BOMBAY.



1

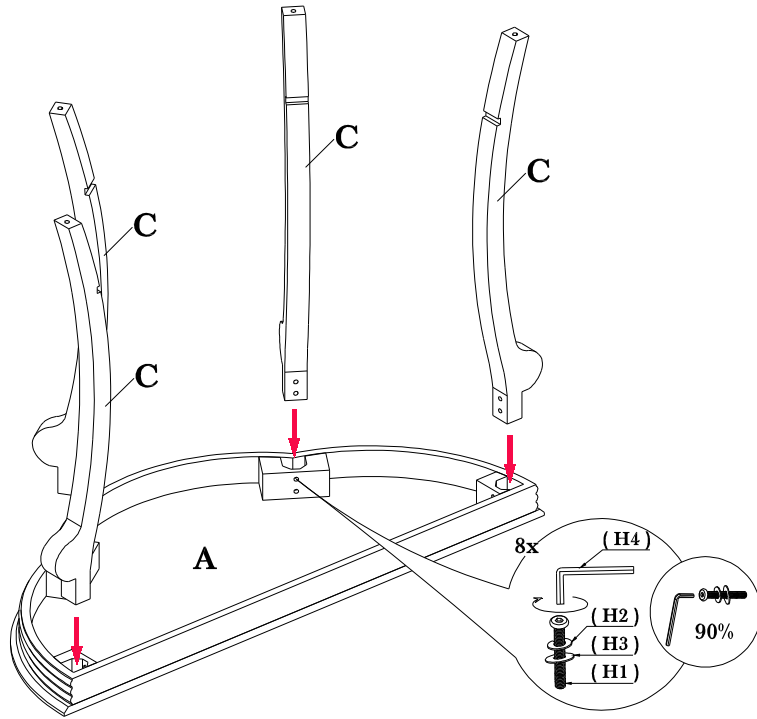

2

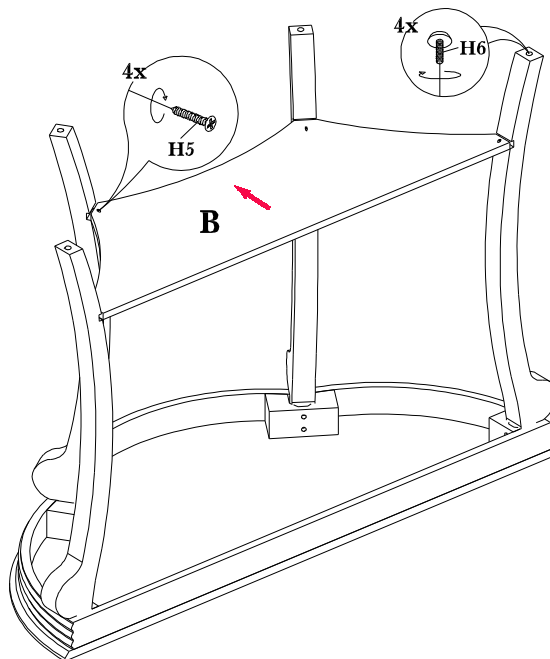

BOMBAY®



3

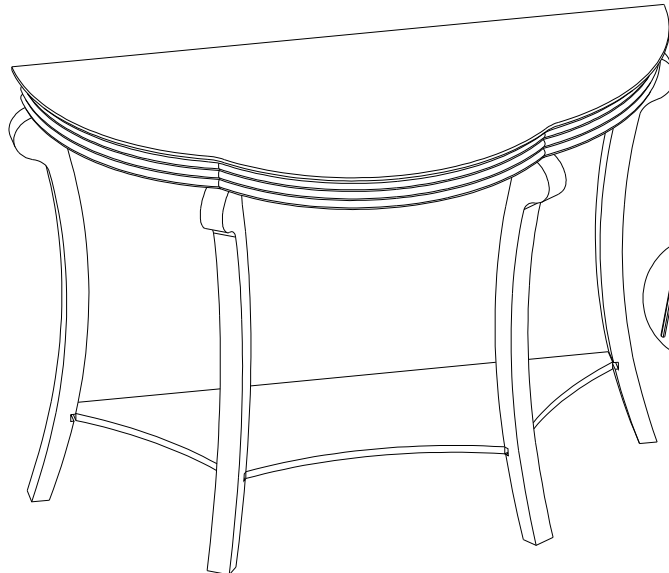

Care Instructions

Dust with a clean, soft damp cloth. Wipe immediately. To protect the finish, avoid the use of all chemical and household cleaners, rough cleaning pads, polishes and abrasives as they may damage finish.

Instrucciones de cuidado

Limpie el polvo con un paño limpio, suave y húmedo. Séquela inmediatamente para proteger el acabado. Evite el uso de productos de limpieza químicos, estropajos ásperos, pulidores y productos abrasivos porque puede dañar el acabado.



OTTO INTERNATIONAL (USA) LLC
489 FIFTH AVENUE, PH NEW YORK, NY 10017
www.bombaycompany.com

MADE IN CHINA
HECHO EN CHINA