

UKINOX SPECIFICATIONS

MODEL D537.80.20

UNDERMOUNT TYPE

GENERAL

Fine quality sink bowl formed of 18 gauge
Type 304 18/10 nickel bearing stainless steel

DESIGN FEATURES

- Bowl Depth: 10"
- Large bowl with a 6" deep Small bowl
- Finish: European Finish
- Underside: Sound absorbing pads and special paint applied to dampen sound
- Drain Openings: 3-1/2"

Sinks include all basket strainers, mounting hardware and template.

PROTECT YOUR SINK! Grids prolong the life of your sink's finish.

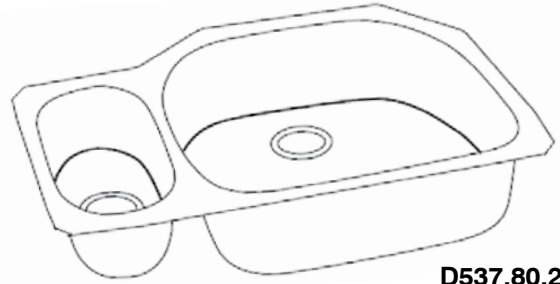

D537.80.20 R

- D537.80.20.10L (large bowl on left - 10" deep)
- D537.80.20.10R (large bowl on right - 10" deep)

OPTIONAL ACCESSORIES

(for large bowl only)

- GR537SS Stainless Steel Bottom Grid
- RB537SS Stainless Steel Rinsing Basket
- CB537HW Wood Cutting Board

SINK DIMENSIONS (INCHES)

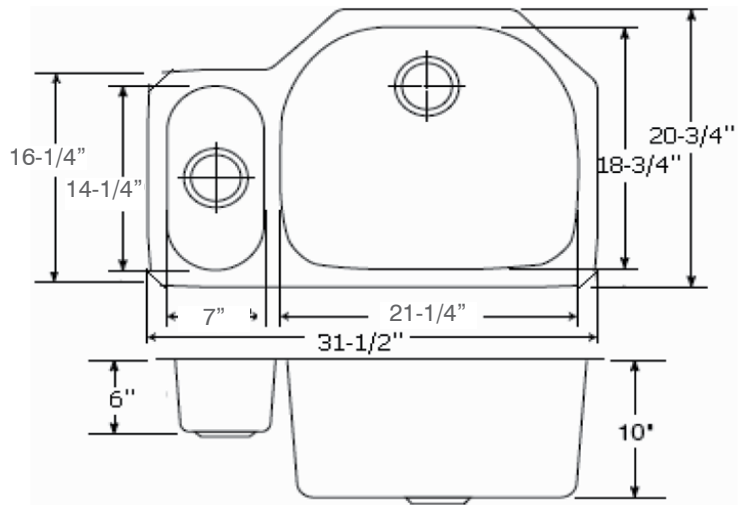
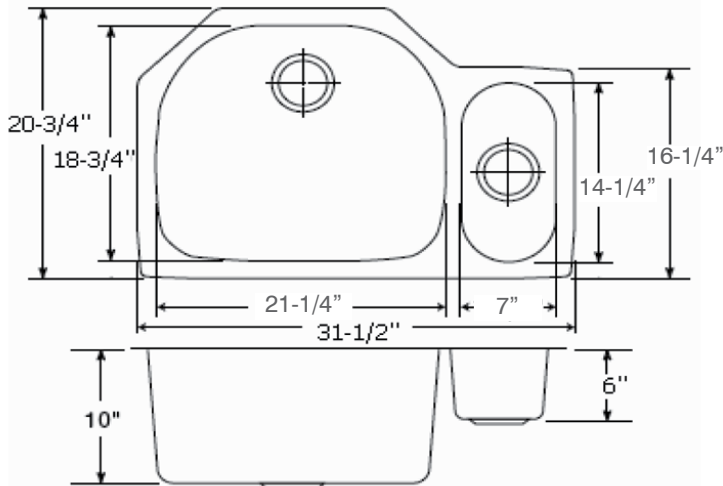

Minimum Cabinet Size 33"
Ship Weight 19 Lbs

Installer Notes: Ukinox always recommends that you give the sink to the granite fabricator. If you are going to use a cutting board, provide that to the fabricator as well. Please note that we do include a template with each sink, but there can always be a slight variation. In addition, many of our templates are perforated so you can tear off the perforation for cutting board applications.



*Template and countertop mounting clips are packed with every sink

Ukinox reserves the right to change product specifications without notice.

