

Integrity[®] Collection Specifications

Whirlpool & Soaking - K3666

SL/SR

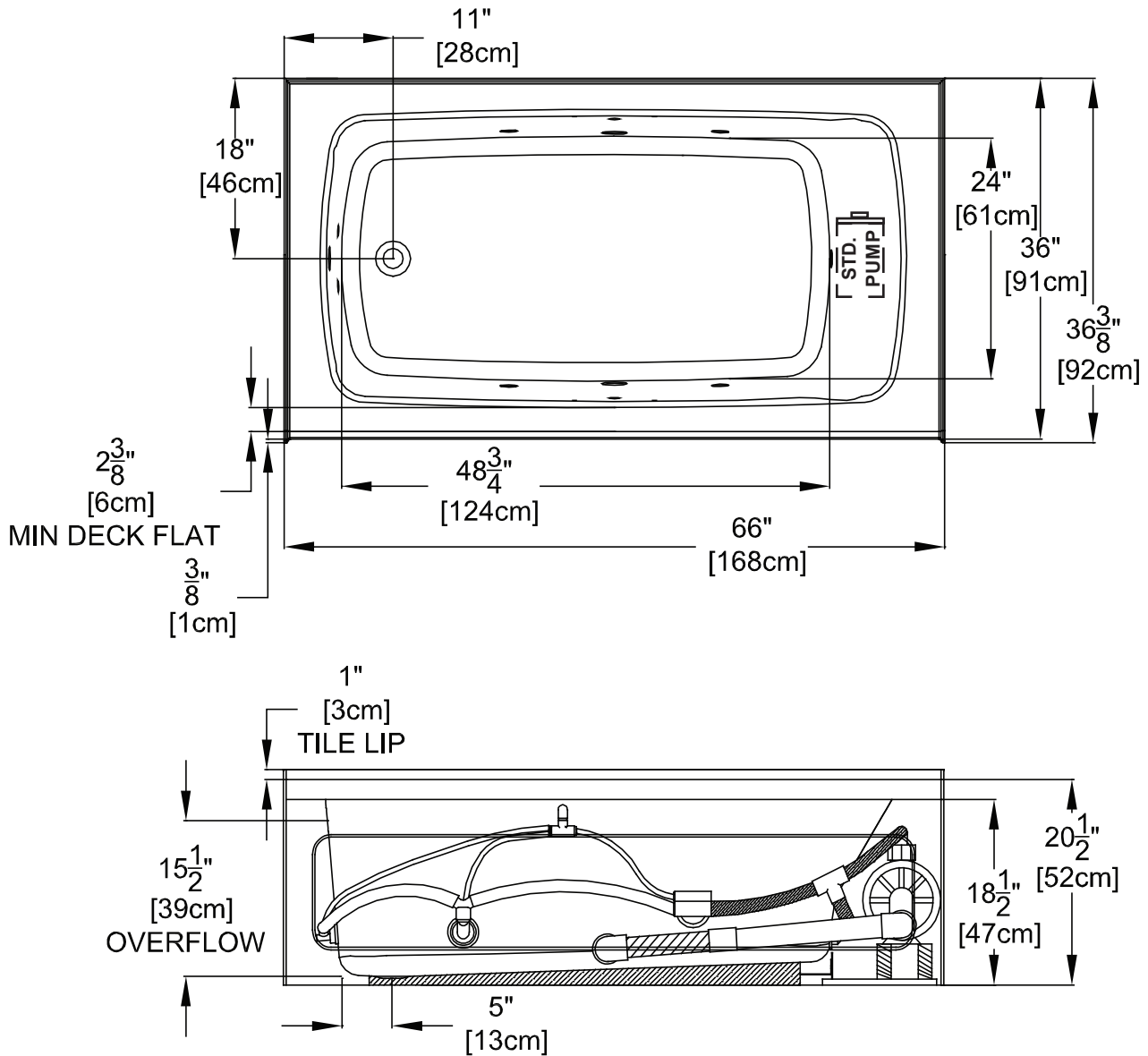

Patents received or pending.

Note: Dimensional Tolerances: ±1/4"

Drop-in-Hole Size:	N/A
Operating Capacity:	48 Gal.
Overflow Capacity:	75 Gal.
Floor Loading / sq.ft (WP/Soaking):	51.4 / 48.7 lbs.
Carton Wt. (WP/Soaking):	128 / 93 lbs.
Cube:	34.3 ft. ³

Air Switch Control

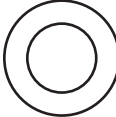

Includes a quiet, 120v, 1HP, 1-speed pump and an air switch on/off control. Requires (1) 20A, 120v GFCI protected circuit.

Construction: Reinforced Acrylic shell mounted on Level Form™ pre-leveled full support base.

We provide products listed with Intertek ETL SEMKO (Edison Testing Laboratories) U.S. and Canadian and with International Association of Plumbing and Mechanical Officials (IAPMO). Consult factory with your listing requirements.