

THANK YOU FOR PURCHASING FROM BELMONT DECOR

Our visual installation guide contains important information to help you install and care for your vanity. Please read these instructions thoroughly before starting your installation. Carefully unpack and inspect your product for damages. Please note that the appearance of your vanity may differ from the illustrations of this guide.

ROUGH-IN DIMENSIONS

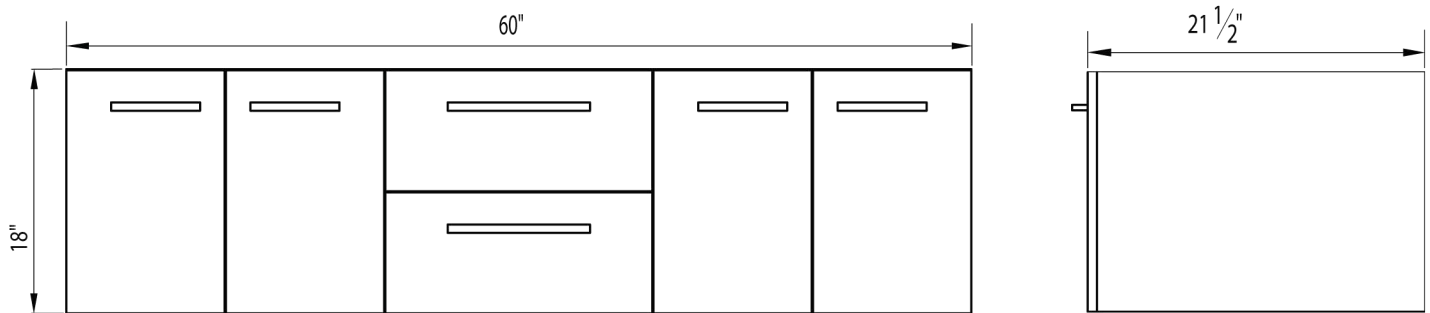

CARE AND CLEANING

A new bathroom vanity cabinet can give you more counter space and better storage options. Installing a vanity is almost the same as installing a kitchen cabinet. Vanities tend to get a lot of use and are exposed to moisture, pay particular attention to the quality of construction.

- Avoid direct sunlight and extreme weather changes.
- Dust the vanity frequently with a soft, clean, dry and/or lint-free cloth. Clean the surface in the direction of the grain.
- Abstain the use of silicone cleaners and waxes.
- Please note that some chemicals may damage the finish.
- Clean excess water and spills immediately by blotting rather than wiping. Water left over a long period of time may cause spots.

SUGGESTED TOOLS AND MATERIALS



Philips Screwdriver



Tape Measure



Safety Glasses

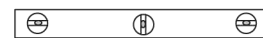

Level



Drill

SKYLINE

DW1D4-60
SPECIFICATION SHEET

PRODUCT DIAGRAM

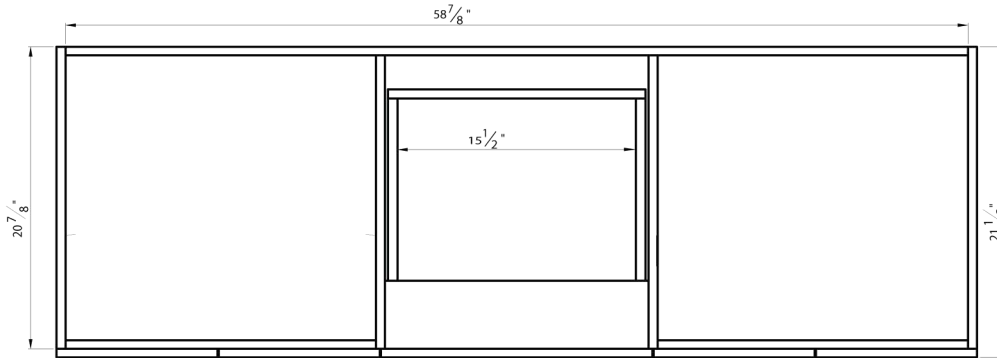

TOP

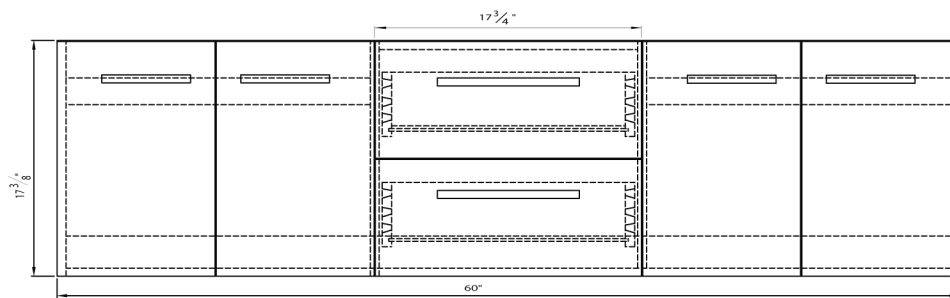

FRONT

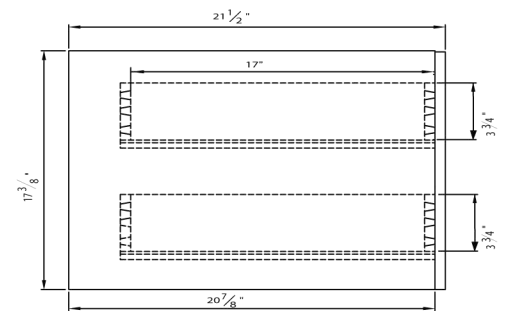

SIDE

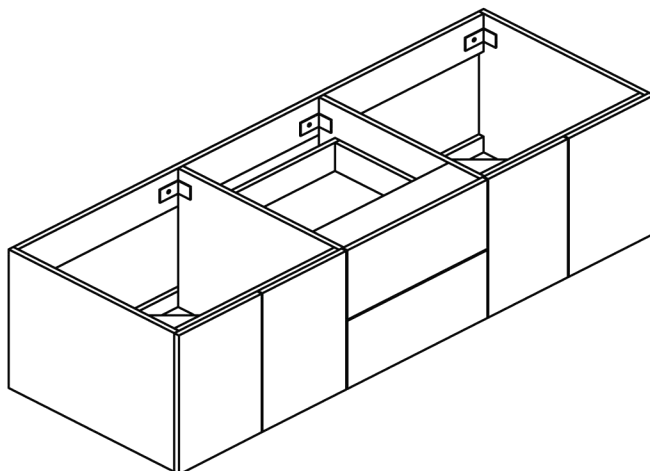

FEATURES

- Four doors with soft-closing hinges
- Two drawers with soft-close glides
- Solid wood frame

COLORS / FINISHES

- BK Black
- ES Espresso

NOMINAL DEMENSIONS

- 60" Width x 21.5" Depth x 17.375" Height