



**Pali Design, Inc.**

1525 Hymus Boul.  
Dorval, QC  
H9P-1J5 Canada  
Phone: 1-514-421-0309



customerservice@pali-design.com

www.pali-design.com

# Assembly Instructions

## Torino 5-Drawer Dresser

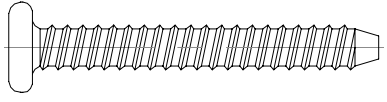
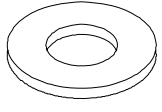
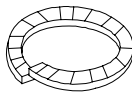
### Hardware Parts List

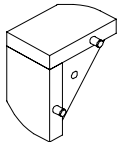
<b>A</b> Allenhead Bolt  <b>4x</b>	<b>B</b> Metal Washer  <b>4x</b>	
<b>C</b> Spring Washer  <b>4x</b>	<b>D</b> Allen Wrench  <b>1x</b>	
<b>Parts List:</b> <b>E</b> Foot  <b>4x</b>	<b>INSTRUCTION LEAFLET</b> <i>Important, keep for future reference. Read carefully.</i> <b>Adult assembly is required.</b>	

Double Dresser

Step **1**

### Assembling Torino 5-Drawer Dresser

**Hardware Preparation**

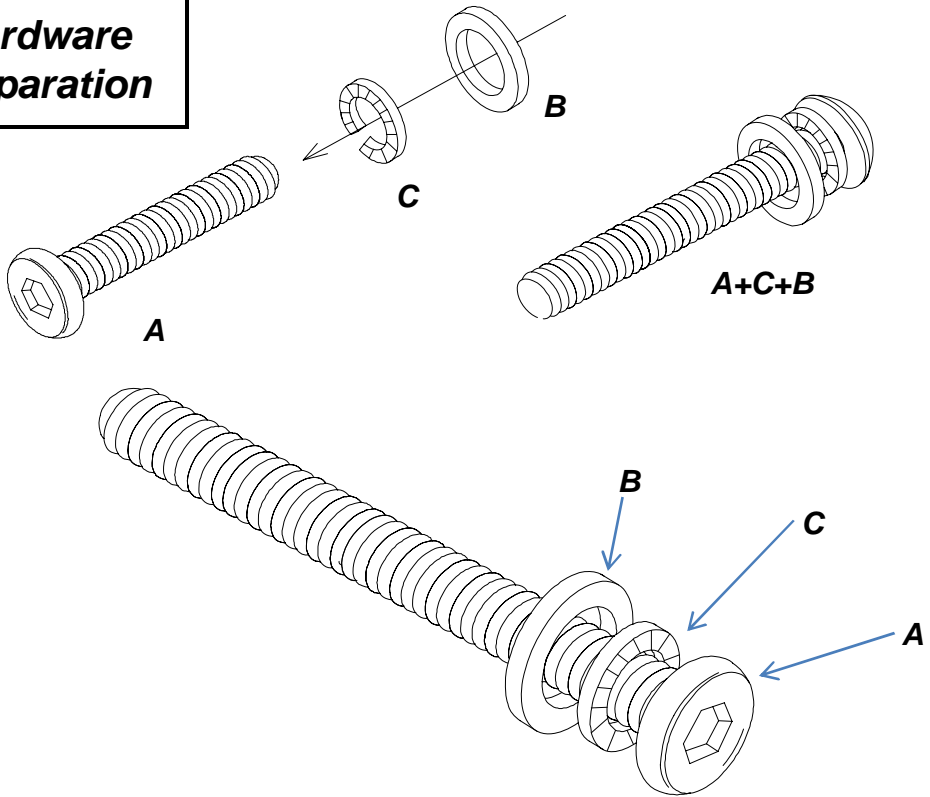

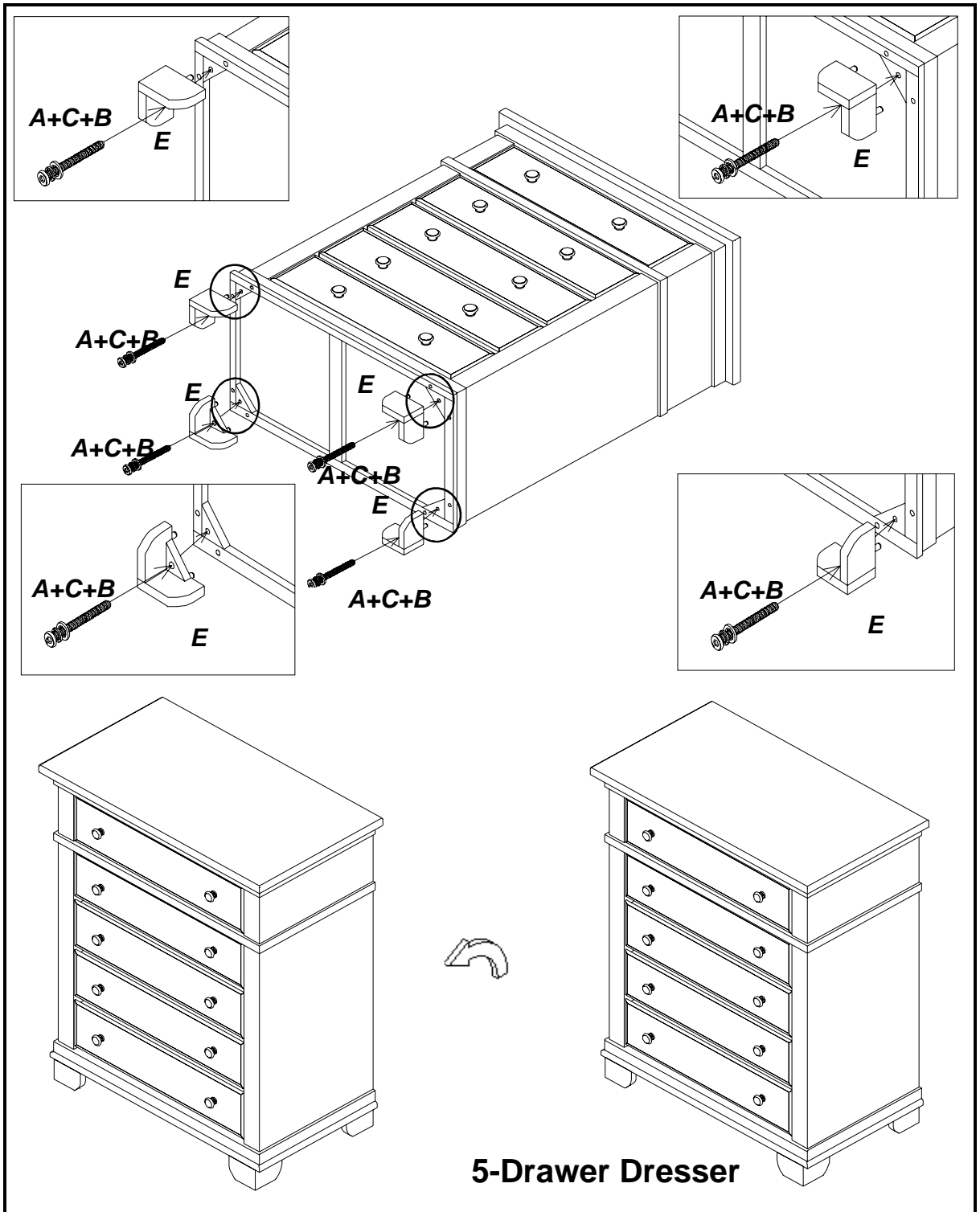

 **CARE AND MAINTENANCE**

When cleaning your furniture, please use a non-toxic, non-abrasive cleaner. Mix a solution of water with a small amount of mild dishwashing liquid. Apply to furniture surface with a soft, damp cloth lightly dampened in solution. After cleaning, dry completely with a soft, dry cloth.