

# ROSE

Health Care, L.L.C.

*Outstanding  
Customer Service*  
*Quality Products*  
*Fair Prices*



*Be Active  
Be Comfortable*

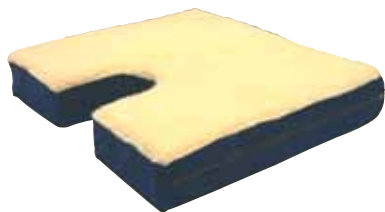

224 Rose Drive • Brunswick, Georgia 31520  
Call Toll-Free (800) 457-7648 or Fax Toll Free (800) 536-2017  
or Call (912) 466-0022 or Fax (912) 466-9884  
rosecare@bellsouth.net • www.rose-healthcare.com

# ROSE

Health Care, L.L.C.

224 Rose Drive  
Brunswick, GA 31520

Call Toll-Free (800) 457-7648

(912) 466-0022

Fax Toll Free (800) 536-2017

(912) 466-9884

e-mail: [rosecare@bellsouth.net](mailto:rosecare@bellsouth.net)

## A Message From Rose Health Care...

Our purpose is to provide quality health care products at fair prices with outstanding customer service. This positive approach comes from the many years our management team has spent in the health care field. We appreciate the support from our loyal customers who have helped us become one of the fastest growing companies in the health care field.

Our product line of durable medical equipment and medical soft goods consist of direct imports and products we manufacture in our own facilities.

Our new catalog contains a vast array of new products. We welcome the opportunity to be of service to you and your company.



**"THE WINNING TEAM"**  
*Thanks for the opportunity to be of Service*

Don Mann

Sandy Stossmeister

## Meet The Rose Health Care Team

**Don Mann (President)** Co-Founded Duro-Med Industries and served as its president for almost 25 years. In 2001 he joined with several former employees of Duro-Med and formed Rose Health Care. His extensive experience in product development and marketing help make Rose Health Care an important factor in the market place.

**Sandy Stossmeister (Vice-President)** Served in various executive positions with Duro-Med and provides a strong background and expertise in operations, customer service and sales.

**Dave Hirsh (Director of Purchasing)** Formerly Vice-President in charge of Purchasing with Duro-Med brings over 30 years of experience in the health care field. He has traveled extensively in the Far East and has developed resources all over the world. This has enabled Rose Health Care to be extremely competitive.

Plus a loyal and devoted group of employees. That help make up **"The Winning Team"**.



**Catalog is available online at:**  
**[www.rose-healthcare.com](http://www.rose-healthcare.com)**

## What Our Customers Say About Us

"We can call and get a live person on the phone who is eager to help us in any way."

"If they don't have the product we are looking for, they will help us find the source."

"Rose Healthcare is always coming up with new and creative products."

"I always receive my products within a few days and that makes our customers happy."

\*Providers are responsible for determining appropriate billing codes for Medicare Program claims This information is included for your convenience and is not intended, nor should it be considered billing advice.

**Quality Products • Fair Prices • Outstanding Customer Service**



HCPCS  
E0143W

HCPCS  
E0156

## Four Wheeled Rollators

- Adjustable height handles with comfortable foam hand grips: adjusts 34" - 38"
- Loop-type cable hand brakes operate on rear wheels
- Padded seat lifts up to accommodate removable 6" x 6" x 13" wire basket with handle
- Smooth rolling 6" wheels
- Padded backrest for extra comfort
- Easy folding mechanism for transport and storage
- Lightweight Aluminum - 17 lbs. total - Weight Capacity 250 lbs.

#1010-BL Blue

#1010-BG Burgundy

## Junior 4 Wheel Rollator

- Easy fold 13" x 13" seat
- Lightweight aluminum - 13 lbs.
- Removable padded back rest
- Adjustable height 29" - 34"
- Overall width 22"

#1003 Junior  
4 Wheel Rollator  
Burgundy or Blue

## Transport Rollator

**NEW!**

"Security & Convenience"

- Aluminum frame
- 8" wheels
- Loop brakes - locking wheels when seated
- Padded seat (13"x14")
- Adjustable handle height 34-1/2"-39"
- Weight - 15 lbs. Capacity - 250 lbs.

#1012 BG Burgundy

#1012 BL Blue

HCPCS  
E0143

HCPCS  
E0156



## Light Weight Aluminum Transport Chairs - 19"

- Deluxe nylon upholstery
- Fold down handles for easy storage
- Padded armrests, swing away removable footrests
- Precision sealed wheel bearings
- 8" wheels with rear castor brakes
- Aluminum: 19 pounds without riggings
- Weight capacity: 250 pounds
- Warranty: Lifetime on side frames and cross braces

#1007BL Blue

#1007BG Burgundy

HCPCS  
E1038



Seatbelts Included at No Extra Charge



#1013

## Wheelchair/Transport Chair Safety Seatbelt

- For use on most all wheelchairs and transport chairs
- 60" length, heavy-duty black nylon construction
- Automotive-style push button release buckle

#1013 Wheelchair/Transport Chair Safety Seatbelt



#1009

## Three Wheel Rollators

- Anatomical grip with patented loop braking system
- 8" foam tires with wheel locks
- Foldable for easy storage and transport
- Includes deluxe carrying pouch
- Weight: Standard - 13 pounds
- Weight Capacity: 250 pounds
- Height adjusts 32"-36"

HCPCS  
E0143

#1009 Three Wheeled Rolling Walker-Burgundy

## Universal Car Seat Belt Extender

Comfort & Safety

- Adjusts to add 12" to length
- Shoulder restraints remain intact
- Meets Federal Motor Vehicle Standards (FMVSS) #209 &

#302 approved

\* Black or Gray

#1011 Universal Car Seat Belt Extender

**NEW!**



HCPCS  
E0135

#1000

### Single Button Folding Walker

- Lightweight 1" anodized aluminum frame
- Single release folding mechanism allows quick and easy fold down
- H-crossbar positioned high for over toilet use
- Height adjusts from 31" to 36"
- 2 per carton, weight - 16 lbs.

### #1000 Deluxe Center Button Folding Walker

HCPCS  
E155



#1004

### Walker Wheels

- Provides easier rolling over different surfaces
- Attaches to front legs of walker only

#1004-3 Walker Wheels, 3" (pair)

#1004-5 Walker Wheels, 5" (pair)

### Walker Ball Glides **NEW!**



- Pre-cut, easily inserted into rear legs
- Perfect for smooth mobility
- Specify red or gray

#1047 Walker  
Ball Glides (pair)



HCPCS  
E0143

### Dual Release Folding Walker

- Lightweight 1" anodized aluminum frame.
- Easy to use dual lever release allows walker sides to fold independently
- H-crossbar positioned high for over toilet use
- Height adjusts from 32" to 39"
- Overall width 22" Overall depth 19" width between grips 18"
- Weight capacity 300 lbs.

#1002 Dual Release Folding Walker

#1002W - Dual Folding Walker with  
5" Wheels, Standard

#1002W-G Dual Folding Walker with  
5" Wheels, Standard - Green

#1002W

HCPCS  
E0135



#3011

### Fleece Walker Grip

- Soft synthetic sheepskin
- Adjusts with hook and loop closure
- Machine washable

#3011 Fleece Walker Grip (pair)

### Ski Walker-Glides **NEW!**



- Greater stability and ease of motion
- Simply slip on base of walker shaft
- Sturdy rubber and nylon
- 3-3/8" x 2" x 1-1/2" overall

#1021 Ski Walker-Glides  
(pair)

**NEW!**  
Lever  
Release



#1002W



**300 LB**  
WEIGHT CAPACITY

HCPCS  
E0154

#1198

### Universal Platform Walker/Crutch Attachment

- Designed for those who are unable to grip the walker
- Cradles forearm with soft vinyl padding for comfortable weight bearing
- Universally adjustable
- Adjustable strap securely holds arm in place
- Fits most manufacturers walkers

#1198 Universal Platform Walker/  
Crutch Attachment



**NEW!**

### Walker Glides

- Easy to install, simply insert into walker leg
- Fits 1" leg tubing

#1001

# 1001 Walker Glides (pair)



#1001A

#1001A Universal  
Walker Glides  
(fits 7/8" & 1" tubing)  
(pair)



**NEW!**

### Walker Coaster Glides

- Replace tennis balls, wheels and rubber tips on walker legs
- Easy install: remove existing cover and press firmly to insert coaster center inside 1" standard tubing

#1016 Walker Coaster Glides  
(pair)

**NEW!**



### Walker Tray & Storage Caddy

- Fits standard folding walkers
- Attaches easily with side straps
- Removable top for storage of personal items
- Heavy duty plastic - cleans easily
- Size 15-1/2" w x 11-3/4" d x 5" h

**#1214 Walker Tray & Storage Caddy**



**NEW!**

**#1212**

### Walker Tray

- Durable heavy duty plastic tray
- Fits securely on side-bars of any standard walker
- Raised edges and 2 recessed cup holders

**#1212 Walker Tray 21" x 16" (Gray)**

**#1212B Walker Tray, (Blue)**

**NEW!**



Patent Pending  
Total Weight - 4 lbs.

### Portable Wheelchair Desk

- Unique clamp secures easily to any wheelchair, not adding extra width
- Adjustable aluminum tubes fit into clamp and each other
- Height can be adjusted - 6" to 30" (3 tubes 7", 9", & 14")
- Table Top - Polypropylene (11-1/2" x 7-3/4")
- Cup holder - 4" w x 4" h and versatile hook for easy package carrying

**#2049 Portable Wheelchair Desk**

**NEW!**



### Padded Walker Seat

- Padded seat fits most walkers
- Attaches easily with hook & loop fasteners
- Supports up to 250 lbs.
- Washable leather like cover

**#2085 Padded Walker Seat (24" x 8" x 3")**

**Flips down to sit - up when walking!**

HCPCS  
E0156



**NEW!**

### Multi-Purpose Organizer

- Perfect for walkers, wheelchairs, rollators, etc.
- Multiple storage pockets on both sides
- Extra wide zippered pockets
- Hook and loop closure
- Water proof neoprene, washable

**#1027 Multi-Purpose Organizer**

**8-1/4" x 10-1/2"**



**#1014**

### Universal Walker Basket

- Universal Snap on brackets
- Vinyl coated wire basket resist rust
- Vacuformed plastic tray for bottom of basket with cup holder

**#1014 Walker Basket 16" x 6" x 7"**

HCPCS  
E1399

**NEW!**



### Oxygen Tank Holder for Wheelchairs

- Designed to hold D & E tanks
- Heavy duty waterproof nylon
- Holder off center for user comfort
- Quick release buckles to remove

*NOW AVAILABLE IN BLACK OR BURGUNDY*

**#2088 Oxygen Tank Holder**



**PERFECT FOR SCOOTER & WHEELCHAIR ARM RESTS & WALKERS**

#1018B

**Universal Quilted Pouch\***

- Large 15 1/2" x 11" pocket
- Two inner 4" x 5" pockets
- Attractive fancy prints (blue, red, black)
- Designed to fit walkers and wheelchairs
- Machine washable 14" x 16"

**#1018 Universal Quilted Pouch\***

**\*Available in Fancy Prints**  
 Add FRD or FBK to Item Number #1018 or #1025

	
FANCY RED FRD	FANCY BLACK FBK



#1025

**Quilted Mini Walker**

- Attractive fancy prints (blue, red, black)
- Fits all tubular products
- Features front and back pockets
- Hook and loop closure
- Machine washable 9" x 12"

**#1025 Quilted Mini Walker Pouch\***



**NEW!**

#3123

**Cup 'n Stuff Holder**

*Ideal for Wheelchairs, Scooters, Walker, etc.*

- Insulated pocket
- Two exterior mesh pockets
- Attaches easily with hook & loop strap
- 3.5" x 5.5" H x 3.5" D

**#3123 Cup 'n Stuff Holder**

**Deluxe Wheelchair Organizer** **NEW!**



- Secures easily to back of any wheelchair
- Nine separate pockets for total storage
- Completely washable red on black poly cotton blend

**#1149 Deluxe Wheelchair Organizer (17" W x 19 1/2" T)**



#1037

**Denim Carry-All**

- Washable Blue denim
- Attaches with Velcro closure and tapes ties
- Large main compartment for books, etc.
- Three additional pockets in front
- Size 13" L x 9 1/2" H

**#1037 Denim Carry-All**



#1015

**Universal Denim Pouch**

- Designed to fit walkers and wheelchairs
- Blue denim fabric with straps and velcro
- Two inner pockets, machine washable
- 12" x 14" x 13-1/2"

**#1015 Universal Denim Pouch**



#1146

**Wheelchair Carry All**

- Fits easily over wheelchair handles
- Heavy duty smooth vinyl finish
- Totally waterproof & stain resistant
- Easy pull zippers with top and middle compartments
- Colors: Maroon or Black
- 4-1/4" x 14" x 14"

**#1146 Wheelchair Carry All**



#1017

**Universal Wheelchair Backpack** **NEW!**

- Convenient heavy duty storage for standard wheelchair
- 2 large pockets, 2 side pockets
- 14" w x 13" h x 6-1/2"

**#1017 Universal Wheelchair Backpack**



**Fleece Armrest and Pouch**

- Attaches easily with hook and loop fastener over wheel chair arms
- Comfort plus convenient storage
- Blue denim with fleece-covered armrests

**#1019 Fleece Armrest and Pouch (one pair)**



#1023

**Wheelchair Wheel Pouch**

- Large outer pouch carries reading materials, clothing articles and personal items
- Inner pouch secures cell phones, remotes and valuables in any of the three secure pouches
- Quilted, machine washable fabric attaches to most any wheelchair with secure hook and loop fasteners

**#1023 Wheel Pouch**



**#1116**  
**Ergonomic Palm Grip Cane**

- Unique molded grip
- Directs users weight for stability
- Black aluminum adjustable shaft
- Shaft adjusts from 28" to 36"
- Available in left or right hand

**#1116 Right Palm Grip**  
**#1117 Left Palm Grip**



**Fancy Offset Handle Adjustable Canes**

- 1" anodized aluminum
- Adjusts from 31" to 40"
- Wrist strap and silencer
- 300 pound weight capacity

**#1108FBK Fancy Black Paisley**  
**#1108FBL Fancy Blue Paisley**  
**#1120B Black**  
**#1120P Purple**  
**#1120G Green**  
**#1120F Fuchsia**

**#1108FBL**

**HCPCS E0100**



**T-Handle Fancy Adjustable Canes**

- 1" anodized aluminum
- Adjusts from 31" to 40"
- Wrist strap and silencer
- 300 pound weight capacity

**#1109FBK Fancy Black Paisley**  
**#1109FBL Fancy Blue Paisley**

**#1109FBL**

**HCPCS E0100**



**Aluminum Canes**

- Height adjustment - 31" - 39"
- Available in Offset or Standard

**Offset Handle Models**

**#1095 Gray Vinyl Grip, Silver Shaft**  
**#1096 Black Vinyl Grip, Black Shaft**  
**#1097 Black Foam Grip, Bronze Shaft with Wrist Strap**

**Curved Handle Models**

**#1098 Ladies' Style**  
**#1099 Gray Vinyl Grip, Silver Shaft**

**HCPCS E0100**



**Lucite Deluxe Clear Cane**

- Heavy duty acrylic
- Clear finish - 37" long
- Reinforced Tip

**#2003 Deluxe Clear Cane**

**NEW!**



**Adjustable Folding Canes**

- Anodized aluminum finish
- T-shaped handle
- Folds easily for travel or storage
- Height adjustment - 31" - 37"
- Convenient carry and display pouch

**#1086 Bronze**  
**#1094 Black**  
**#1105FBK Fancy Black Paisley**  
**#1105FBL Fancy Blue Paisley**  
**#1194 Fancy Cane Bag (Available in Red, Blue or Black Fancy)**

**HCPCS E0100**

**NEW!**

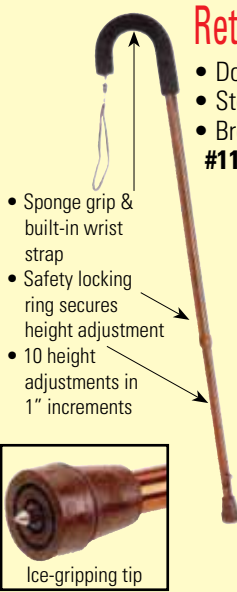

**Retractable Ice Cane**

- Double-duty cane provides extra safety
- Steel ice-gripping tip emerges from the bottom of cane
- Bronze anodized aluminum.

**#1110 Retractable Ice Cane**



**Ice Grip Attachment**

- Attaches to any wood or aluminum canes
- Fits most standard crutches
- Unique design lifts up when not in use
- Attaches easily

**#1087 Ice Grip Attachment**



Ice-gripping tip

**Winter Non-Slip Ice Treads**

**#1034M (Sizes 6-12)**  
**#1034W (Sizes 5-10)**

**NEW!**

## Derby Designer Wood Canes



- 36" length
- 7/8" in diameter
- Extra sturdy
- Six stylish choices
- Firm gripping, rubber tip

**#1106DP - Deal Pack  
One Each Style  
(Canes may also be  
ordered individually)**

**HCPCS  
E0100**

## Ergonomic-Pivot Walk Easy Cane



- Unique design can be used on any surface and stair climbing
- Ergonomic hand grip
- Large foot pad spreads weight
- Cane pivots for greater stability
- Durable Steel construction
- Adjusts from 33" to 37"
- Weight capacity 300 lbs.

**#1107 Ergonomic-Pivot  
Walk Easy Cane**



**HCPCS  
E0100**

## Wood Laminated Canes

- 37" long, 7/8" width

**#1111 Walnut  
#1112 Rosewood**

**#1113 Natural  
#1114 Ebony**



## Sit & Rise Cane

- Adjustable aluminum cane (31-1/2" - 40-1/2")
- Weight capacity - 250 lbs.
- Features two easy-grip foam handles - makes it easy to sit and rise.
- Black or Bronze

**#1196 Sit & Rise Cane**



## Rose Handy Seat & Walking Stick

- Lightweight durable anodized aluminum
- 34" tall, 21" seat height
- Folds flat and holds up to 250 lbs.
- Weighs 28 ounces

**#1085 Rose Handy Seat  
#1085C Fleece Seat Cover**

**250 LB  
WEIGHT LIMIT**



## Cane Stabilizer Tip

- Lightweight, sturdy rubber tip suitable for most canes
- Compact design allows ease of use on stairs
- Easily navigate uneven terrain or loose surfaces
- Base features non-slip, enhanced traction design
- Stands on its own-no more retrieving fallen canes!
- Enhances user stability, and reduces fatigue associated with stress impact to hand, wrist and elbow

**#1118 Cane Stabilizer Tip  
4" W x 4" L**

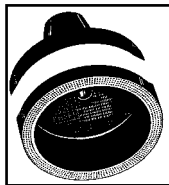

**NEW &  
IMPROVED  
DESIGN**

## Safety Cane Tip



- Self standing base (3")
- Greater stability on wet or dry surfaces
- Attaches easily to most aluminum canes
- Unique design creates complete gripping action of base - regardless of angle
- Base 3" high for maximum stability

**#1119S Safety Cane Tip**



## Cane/Sling Seat

- Dual purpose cane and seat rest
- Aluminum bronze frame
- Nylon seat - 18"x8"
- Foam grip handles
- 34" tall, seat to floor height-22"

**#1132 Cane/Sling Seat**

## Adjustable Cane Seat

- Light weight, durable aluminum
- Folds into a walking stick
- Overall weight: 2 lbs
- Walking height: 34"-38"; Sitting height: 18"-21"
- Seat dimensions: 8"x10"

**#1085B Adjustable  
Cane Seat**







### Low Profile Quad Canes

- Anodized 7/8" aluminum shaft, silver or bronze finish
- Low profile steel base, chrome, gray or black finish narrow 6" x 8" or wide 8" x 12"
- Offset handle, molded gray vinyl or black hypalon foam handgrip
- Spring button height adjustment
- Safety lock silencer ring
- Reinforced rubber tips
- Height adjustment - 29" - 38", Shipped 2 per carton, 7 lbs.

HCPCS E0105

#### Small Base

- #1090 Silver
- #1092 Bronze (Black Base)

#### Large Base

- #1091 Silver
- #1093 Bronze (Black Base)



#2000



### Fleece Crutch Pad Set

- Soft 1" thick synthetic fleece.
- Machine washable.
- Set - pair arm and grip pads

#### #3010 Fleece Crutch Pad Set

HCPCS E0114

### Push Button Aluminum Crutches

Each set consists of Crutches, Tips, Arm & Handgrips

- Made from 3/4" anodized tubing
- Easy push button adjustment with user height scale
- Preformed bows maintain their shape during adjustment

#2000 Tall, for user height 5' 10" - 6' 6"

#2001 Adult, for user height 5' 2" - 5' 10"

#2002 Junior, for user height 4' 7" - 5' 3"

#2005 Complete Set of Pads, Handgrips and Tips

#1102 Large Crutch Tips (#50)

#1103 Jumbo Crutch Tips (#40)

HCPCS E0104



#1005D Deluxe Knee Scooter

350 LB  
WEIGHT CAPACITY

### Deluxe Knee Scooter

- 4 large 8" rubber wheels with sealed bearings
- Adjustable hand brake, lockable "parking feature"
- Padded knee platform with easy folding mechanism
- Includes handy storage basket
- Padded foam handle-bar grips
- 120° turning radius
- Offset post on knee platform allows for right to left adjustment
- Powder coated black frame finish
- Two year warranty
- Knee Platform 7" w x 14" l
- Height adjusts 31" - 41"



#1199

### Forearm Crutches

HCPCS E0110

- Vinyl coated, ergonomic contoured arm cuffs molded for comfort and stability
- Leg and forearm adjust independently
- Hand grips are comfortable and durable
- Extra large tips for added security
- Adjust 28 - 37"

#1199 Forearm Crutches (one pair)  
(Fits Adults 5'0 to 6' 2")



### Blind Visually Impaired Folding Cane

- Putter grip, wrist strap and nylon tip
- Red reflective tape on end for added safety
- Available in either 44" or 60" lengths

#2035-44 Blind Visually Impaired Folding Cane 44"

#2035-60 Blind Visually Impaired Folding Cane 60"

HCPCS E0135

#1008

### Folding Walkcane

- Two sure grip hand holds
- Lightweight anodized aluminum design folds easily
- Special angled footpieces provide safety
- Adjustable height from 28" - 33"
- 2 per carton, weight - 9 lbs.

#1008 Folding Walkcane



## Wheelchair Positioner

- Designed for patient security and good posture
- Fits standard wheelchair and transport chairs
- Black nylon waterproof cover
- Foam meets CAL #117

**#2087 Wheelchair Positioner**  
(26" x 3-3/4" x 10")

**NEW!**



## Universal Cane Clip

This double clip device can be used for canes as well as many other possibilities. One side can be locked onto a wheelchair via our rubber ring system, the other clip is plastisol coated to grip canes, reachers, etc. 1/pkg.



**#1188**

**#1188 Universal Cane Clip**



## Fleece Cane Grip

- Unique design enables easy attachment
- Designed to fit wood canes and aluminum canes with wood handgrips
- Hook and loop closure
- Machine washable

**#1186 T Handle**  
**#1187 Curved Handle**

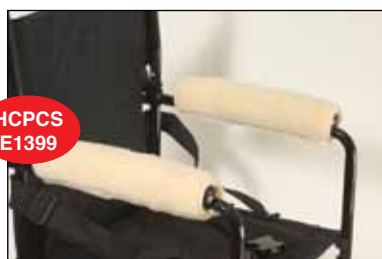

**HCPCS  
E1399**

## Fleece Wheelchair Armrest

- Helps prevent achy arms and elbows
- Attaches easily with hook and loop closure
- Washable poly acrylic fabric

**#3009-10 Fleece Armrest 10"**  
**#3009-14 Fleece Armrest 14"**  
**NEW! #3009-10F Fleece Foam Armrest 10"**  
**NEW! #3009-14F Fleece Foam Armrest 14"**



## Universal Cane Strap

- Attaches to most any wood or aluminum cane
- Long lasting nylon strap

**#1089 Universal Cane Strap**



## Non-Slip Cane Holder

- Unique design prevents cane from falling
- Fits all canes
- Holds cane on top or bottom of any shelf or table

**#1088 Non-Slip Cane Holder**



## Clamp-On Cup Holder Attachment

- Attaches easily to most wheelchairs and walkers
- Two clips to fit 7/8" and 1" (22 and 25mm) round tubes are included
- The cup holder alone can be easily removed
- No tools required

**#3125 Clamp-On Cup Holder**



## Clear Acrylic Wheelchair Tray

- Perfect for eating, writing and reading
- Ultra lightweight, highly functional
- Completely transparent for maximum safety
- Universal design fits all standard wheelchairs
- Equipped with hook and loop straps for easy attachment
- 23" x 19" x 1/4"

**HCPCS  
E0950**

**#2046 Clear Acrylic Wheelchair Tray**



## Wheelchair Trays

- Ideal for eating, writing and reading
- Raised T-molding on outside edges
- Universal design fits all standard wheelchairs
- Walnut laminate top easy to clean
- Easy to use hook and loop straps

**#2048 Adult Wheelchair Tray**  
24" x 20" x 1/2" 8 lbs.

**#2050 Economy Hardboard Wheelchair Tray**  
24" x 20"



HCPCS  
E0310

#2008

### Half-Length Rails

- Fits standard hospital beds with easy action clamp – tool free assembly
- Anodized aluminum 1" diameter tubing
- Overall length: 37"
- Height above spring, up: 16"
- Shipped 1 pair per carton, 14 lbs.

#2008 Half-Length Rails



HCPCS  
E0274

#2010

### Overbed Tables

- Available in both tilt and stationary tops
- 30" x 15" wood grain laminated top with raised plastic edge on tilt top prevents items from rolling off table top. Makes an excellent dining, reading or work surface
- Chrome plated H base for improved stability, swivel castor wheels allows for easy positioning
- Height adjusts 28" to 45" for use in bed or chair
- Easy assembly, shipped KD 1 per carton – 24 lbs.

#2010 Non-Tilt Overbed Table



EASY  
ASSEMBLY

#2012

#2012 Tilt Top Overbed Table



**NEW!**

Slides between mattress and box spring.

#2107



Easy height adjustment.

### EZ-Grip Bed Rail Support

- Easy to use - in and out of bed
- Slips between box spring and mattress
- Adjusts from 34" to 45" - Height adjusts from 31" to 37"
- Easy padded grip handle - 20" wide
- Tool Free Assembly
- Powder-Coated Steel
- Fits any size bed

#2107 EZ-Grip Bed Rail Support

**GET INTO AND OUT OF BED SAFELY!**

See page 22  
#2007 Swing-Away Bedside Support Rail



HCPCS  
E0310

#2006

### Full Length Steel Bed Rails

- Easily installed on any 24" to 44" wide hospital bed frame
- Telescopes from 48" to 74"
- Chrome steel 1" diameter tubing
- Clamps feature spring loaded clips and buttons
- Height above spring, up: 16"; down: 1"
- Shipped 1 pair per carton, 33 lbs.

#2006 Full Length Steel Bed Rails



#2009

### Home Style Universal Bed Rail

- Powder coated steel for strength and security
- Fits most home style beds including queen and king size beds
- Easily adjusts up or down with spring release
- Easy to install and remove. Adjusts between 36" - 72"
- Weight 30 lbs.

#2009 Home Style Universal Bed Rail



#2019

### Protective Bed Rail Pads

- Anti-bacterial, flame retardant and waterproof cover meets CA #117
- Resilient polyfoam center for extra cushioning
- Secure hook and loop fasteners keeps pad in place
- Easy to install and remove
- Size 60"x15"x1/2"

#2019 Protective Bed Rail Pads (Pr.)

#2019F Fleece Protective Bed Rail Pads (Pr.)

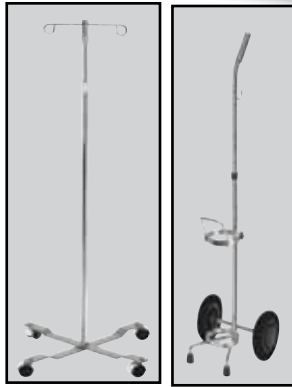

# 1028

# 1029

HCPCS  
E1355

### I.V. Pole

- 4 legs, 2 hooks, Chrome plated steel pole
- Low profile base, Twin wheel swivel castors
- Height adjustment 47" – 85"

#1028 I.V. Pole

### Oxygen Cart for D/E and Cylinders

- Plastic tip screw protects cylinder
- Adjustable height handle
- Chrome plated steel 2 per carton

HCPCS  
E0776

#1029 Oxygen Cart for D/E and Cylinders



HCPCS  
E0910

250 LB  
WEIGHT CAPACITY

# 2038

### Overhead Trapeze Sets

- Chip resistant brown vein finish, square tube steel
- Attaches easily and securely to headboard
- Adjustable, overall height: 64" ships UPS
- Provides free-standing support
- Folds flat for storage

# 2036 Trapeze with Bed clamps

# 2037 Trapeze Base Only

# 2038 Trapeze with Base (complete set)

### Mattress Clamp and Set

NEW!



#2117

HCPCS  
E0809

#2117 Mattress Clamp (Clamp Only)

#2118 Mattress Clamp Set (Velcro Head Halter, Notched Spreader Bar, Rope, 20 lbs Vinyl Bag and Clamp)

#2119 Pelvic Belt (Universal Pelvic Belt) One Size Fit All

#2120 Mattress Pelvic Traction Kit (Universal Pelvic Belt, Rope, 20 lbs, Vinyl Bag, Clamp and Pelvic Belt)

### Total Body Exerciser

NEW!

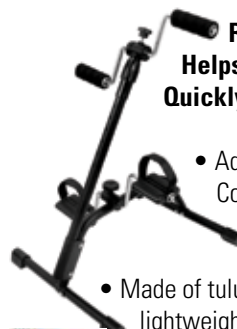

Rotating Handle Bars  
Helps Burn More Calories  
Quickly While Toning Arms

- Adjustable Height & Tension Control for a custom workout
- Pedals have loops for extra security
- Made of tulular carbon steel - lightweight, yet extremely durable
- Compact for easy storage

#1220 Total Body Exerciser

(21-1/2" L x 17" W x 30-1/2" H)



# 2020

HCPCS  
A9300

### Overdoor Exercise Pulley

- Helps restore shoulder, arm and upper torso mobility
- Includes metal door hanger, plastic hand grips and traction cord
- Comes in retail display box

#2020 Overdoor Exercise Pulley



# 2018

HCPCS  
E0860

### Complete Overdoor Traction Set

- Ideal for homecare use when prescribed by a healthcare professional
- Universal self-adjusting, heavy duty hanger and spreader bar
- Adjustable Velcro head halter, one size fits all
- 20 lb. water weight bag
- Comes in retail display box

#2018 Complete Overdoor Traction Set

### Assembled & Folding Pedal Exerciser

- Folds in half for shipping and storage
- Opens fully assembled
- Lightweight steel construction - 6 lbs.

#2023F



FOLD TO STORE: Push and hold the button and bend the leg to fold for storage.  
UNFOLD TO USE: Pull the leg all the way open until the button pops up to lock in place.

NEW!



### Improved NON-SKID Feet

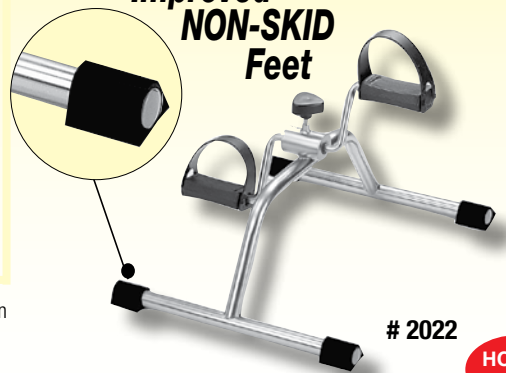

# 2022

HCPCS  
A9300

### Deluxe Pedal Exerciser

- Lightweight chrome plated steel construction.
- Easy to follow assembly instructions.
- Disassembles for easy storage and travel.
- Large central knob provides pedal tension.

#2022 K.D. (Knock Down)

#2023 Assembled

# Deluxe Hardwood or Plastic Transfer Boards and Ramps

## Deluxe Hardwood Transfer Boards

- Easy patient transfer from a wheelchair to a car seat, commode, bed or bath
- Plain or cut-out handle – easy to carry
- Permanent coating for long and easy use
- Lightweight, easy to clean
- 350 lb. weight capacity

- #2040 Solid Hardwood Transfer Board 8" x 24"
- #2041 Solid Hardwood Transfer Board 8" x 30"
- #2042 Solid Hardwood Transfer Board 8" x 30" (Two Cutouts)
- #2043 Solid Hardwood Transfer Board 8" x 24" (Two Cutouts)
- #2044 Solid Hardwood Transfer Board 8" x 24" (One Cutout)
- #2045 Solid Hardwood Transfer Board 8" x 30" (One Cutout)



HCPCS E0705

350 LB WEIGHT CAPACITY

## Deluxe Heavy Duty Transfer Boards

- 1/2" Birch board
- Tapers at both ends
- Measures 8" x 24" weight 2 1/2lbs.
- Supports up to 450 lbs.

450 LB WEIGHT CAPACITY



#9051

### #9051 Deluxe Heavy Duty Transfer Boards

## Plastic Transfer Board

- Made of heavy duty high impact plastic
- Specially molded to ease in moving patient to car seat, bed, commode, or bath
- Compact for travel
- Size - 28" x 8 1/4" x 1 1/4"
- Weight capacity - 350 lbs.

350 LB WEIGHT CAPACITY



#2034

### #2034 Plastic Transfer Board



## Step-Aid

NEW!

- Helps climb steps indoor or out
- Extra large platform (19-1/4"x15-1/2")
- Non-slip design - weather resistant
- Supports up to 440 lbs.

### #8002 Step Aid

## 5' Telescoping Wheelchair Ramps

- Universal design - use for steps, curbs and vehicles
- Adjusts easily with push-button locking
- Heavy duty aluminum construction
- Non-skid treads - 3 section design for easy storage
- Size: 7" wide adjusts from 3' up to 5' long
- Weight for set, 14 lbs. - Weight capacity, 650 lbs.

650 LB WEIGHT CAPACITY



NEW!

### #2039 5' Telescoping Wheelchair Ramps with Carry Bag

## Portable Curb Ramp

- Portable ramp allows wheelchairs, carts, or vehicles to roll up curbs or steps up to 5.5 inches high
- Great for the handicapped, movers, or delivery personnel
- Durable plastic. Mounting holes on sides and bottom
- 23" wide x 13" deep x 5-1/2" high

500 LB WEIGHT CAPACITY



#8001

### #8001 Portable Curb Ramp

NOTE: 2 units may easily be attached together.

### 3-in-1 Commodes

#### Commode-Safety Rail-Raised Toilet Seat



- Steel welded frame
- Plastic contour arm rests
- Seat height adjusts 23-1/2" - 29"
- Overall width 20", Seat depth 5"
- Width between arms 17"
- Weight limit - 300 lbs.

**#1020 3-in-1 Commode (two per case)**

**#1020F 3-in-1 Folding Commode (one per case)**

**Folds flat for shipping and storage**

#1020

HCPCS E0163

#1020F

#### Drop Arm Steel Commode



HCPCS E0165

**300 LB**  
WEIGHT LIMIT

- Arms drop independently and lock automatically in raised position
- Includes seat and removable 6 qt. pail and lid and splash guard.
- Adjusts 17"-22", width between arms 18.5"
- 1 per carton, 18 lbs.

**#1024 Drop Arm Steel Commode**



#1026

#### Commode Cover

- Turns a commode into a chair
- 100% polyester, water resistant and durable
- Fits any standard commode 18"x15"x7"
- 1" foam pad for seating comfort

**#1026 Commode Cover (Hunter Green)**



#1030

#1032

HCPCS E0167

#### Replacement Commode Pails

- Molded plastic with lid on #1032
- Standard on commode's.
- Molded plastic lid with handle on #1030

**#1032 6 Qt. Pail 12 per carton, 10 lbs.**

**#1030 10 Qt. Pail 12 per carton, 13 lbs.**

**#1033 Splash Guards**

#### Replacement Commode Seats

**#1036 Snap-On Seat Assembly**



#1066

HCPCS E0243

#### Toilet Safety Rails

- Coated steel brackets white
- Attaches easily to existing toilet seat
- Padded white arm rests
- Width between arms 18"
- 1 per carton, 8 lbs.

**#1066 Toilet Safety Rails**



HCPCS E0243

#### Standard Safety Frame

- Anodized aluminum, 1" O.D.
- Locking bracket attaches easily
- Can be lifted off floor for cleaning
- Arm height adjusts 28" - 33"
- Width between arms adjusts 20 - 24"
- 1 per carton, 5 lbs.

**#1082 Standard Safety Frame**

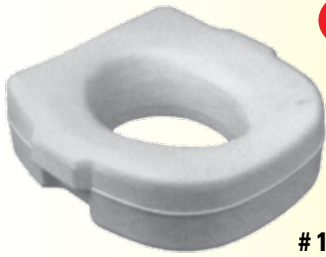

HCPCS  
E0244

# 1046

### Deluxe Toilet Seat with Handles

- Raises toilet by 5"
- Easily cleaned
- No installation required
- Packed 3 per carton

#1046 Deluxe Toilet Seat with Handles



NEW!

#1064

### 3" Elevated Toilet Seat-Open Front

- Comfort plus height
- Durable easy clean plastic
- Side brackets hold in place
- Fits standard and elongated toilets
- 350 lb. weight capacity

#1064 3" Elevated Toilet Seat - Open Front



### Toilet Seat with Locking Mechanism

- Easy hand tightening mechanism safely-secures seat to most toilet bowls
- Lightweight, unbreakable polyurethane, specially molded for sitting comfort
- Raises seat height 5", cleans easily
- 1 per carton, 5 lbs

#1060 Raised Toilet Seat with Locking Mechanism



NEW!

#1044

### Toilet Seat Riser with Arms

- Designed to be used with existing toilet seat and lid, supports up to 300 pounds
- Mounting bolts included
- Raises seat height 3-1/2"
- Large arms for added stability - 19" apart
- Available for standard and elongated bowls

#1043 Standard Bowl

#1044 Elongated Bowl

HCPCS  
E0244



Easy to Install Under Existing Toilet Seat

#1055

### Toilet Seat Riser

- Four piece set elevates seat 3"
- Durable hygienic plastic
- Simple to install – no drilling
- Attaches to existing toilet seat

HCPCS  
E0244

U.S. Patent #6,418,566 (Made in USA)

#1055 Toilet Seat Riser



#1040

### Padded Commode Cushion

- Comfortable soft seat
- Simple installation with hook & loop straps
- Cleans easily and may be removed to clean
- Firm yet comfortable – contour design

#1040 Padded Commode Cushion 2" Height

#1041 Padded Commode Cushion 4" Height



NEW!

HCPCS  
E0244

### Elevated Toilet Seat with Removable Arms

- Adds 5-1/2" to seat height
- Front locking mechanism
- Padded arm rests
- Heavy duty plastic
- Seat width - 17", seat depth - 17"
- Width between arms 19.25"
- Weight limit - 250 lbs.

#1053 - Elevated Toilet Seat with Removable Arms



**250 LB**  
WEIGHT CAPACITY

**HCPCS E0245**

#1054

**Bathtub Stool**

- Sturdy molded polystyrene seat
- Lightweight aluminum frame
- Seat height adjusts 15" - 20"
- Seat diameter 14"
- Reinforced rubber tips
- 2 per carton, 7 lbs. (K-D)

#1054 Bathtub Stool



**400 LB**  
WEIGHT CAPACITY

**HCPCS E0247**

#1056

**Transfer Bench**

- Molded plastic seat and back panels
- Both contoured back rest (17" x 7") and arm rest are reversible for right or left side
- Seat height adjusts 19" - 23", Seat area 26" x 16" with drain holes
- Lightweight 1" aluminum frame
- Reinforced suction feet
- Shipped 2 per carton

#1056 Bath Transfer Bench



**300 LB**  
WEIGHT CAPACITY

**HCPCS E0245**

#1057

**Padded Transfer Bench**

- Soft Cushioned seat and seat back
- Tool free assembly
- Adjustable seat height
- Lightweight 1" aluminum frame
- Suction cup feet
- Shipped 2 per carton

#1057 Padded Transfer Bench



#1048

TOOL FREE ASSEMBLY



#1049

**400 LB**  
WEIGHT CAPACITY

**HCPCS E0245**

**Deluxe Molded Bath Seats**

- Heavy-duty composite construction
- Smooth surface and open water channels
- Easy to assemble-no tools required
- Extra large suction feet for maximum stability
- Seat height adjusts 16" - 21"

#1048 Bath Seat without back 15" x 22"

#1049 Bath Seat with back 15" x 22"



**250 LB**  
WEIGHT CAPACITY

**HCPCS E0245**

#1052

**Bath Bench with or without Back**

- Seats and backs made of blow molded high impact polyethylene – completely closed
- Rustproof anodized aluminum framework, 1" O.D. with sturdy cross-x design to prevent wobbling
- Seat and backrest 12" x 20"
- Seat height adjustment: 16" - 20"
- Backrest height from seat on model 1052, 16"
- Shipped KD, 2 per carton

#1050 Bath Bench w/o back, adjustable (K.D.)

#1052 Bath Bench w/ back, adjustable (K.D.)

**Bathing Safety Seat**



**NEW!**

**SUPPORTS UP TO 250 LBS.**

- Comfortable seat and back rest that goes on sides of tub
- Extra wide seat with front cut-out
- Safety grips hold securely to the sides of tub to prevent slipping
- Durable plastic with rust-resistant aluminum framing
- Fits tub interiors up to 19-1/4" width, total width 28-1/2", seat height 8-1/4"

#1065 Bathing Safety Seat



#1042

**Swivel Bath & Shower Stool**

- 16" seat rotates 360°
- Rust proof sturdy plastic
- Adjustable height 18"-20" with sure-grip feet
- Lower tray perfect for accessories
- Mold and mildew resistant
- 400 lb. weight capacity

#1042 Swivel Bath & Shower Stool

**NEW!**



# Deluxe Bath Bench



#1058

- Lightweight aluminum frame
- Blow molded bench and back
- Corrosive proof with drainage holes
- Armrests for greater comfort
- Seat size, 16" w x 12" d
- Adjustable height legs (16" - 21")
- Packaged 2 per carton

#1058 Deluxe Bath Bench  
#1059 Deluxe Bath Bench With Back

**250 LB**  
WEIGHT LIMIT

**TOOL FREE  
QUICK  
ASSEMBLY!**

HCPCS  
E0240



#1059

## Whirlpool Jet Spa - UL®



Variable Control

**NEW!**

Adjustable  
spray nozzle

- Converts any bathtub to a luxurious spa
- Helps ease muscle tension and stress
- Low-voltage 12V motor
- Strong suction cups attach easily to side of tub
- 16 ft. adaptor cord included
- UL® Listed
- 12-1/4" H x 4" Diam.

#1148 Whirlpool Jet Spa - UL®

## Commode Safety Rail



#1045

**NEW!**

HCPCS  
E1300

**300 LB**  
WEIGHT LIMIT

- Attractive powder coated steel
- Foam-padded handles
- Slip-resistant feet
- Magazine holder
- 24" between handles, 26 1/2" wide

#1045 Commode Safety Rail

## Floor-To-Tub Bath Rail



#1081

- Attaches easily to side of tub
- Adjusts 4" - 6-1/2"
- Extends to floor for maximum support
- 34" height from the floor to top of rail
- Supports up to 250 lbs.

#1081 Floor-To-Tub  
Bath Rail

**250 LB**  
WEIGHT LIMIT



HCPCS E0241

### Chrome Knurled Grab Bars

- 1" heavy gauge steel tubing with 2 1/2" diameter frames
- Diamond-knurled finish provides secure handgripping surface and years of dependable use
- Stainless steel hardware included
- Retail display box
- Available in 5 different sizes, 12- 32" in length
- 1" diameter tubing, 1-1/2" from wall

- #1070 12" Chrome Knurled Grab Bar
- #1071 16" Chrome Knurled Grab Bar
- #1072 18" Chrome Knurled Grab Bar
- #1073 24" Chrome Knurled Grab Bar
- #1074 32" Chrome Knurled Grab Bar

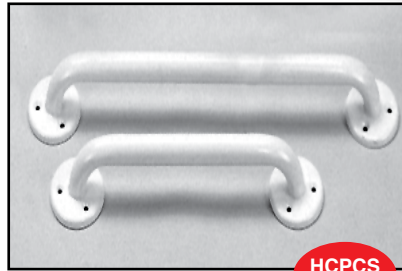

HCPCS E0241

### White Grab Bars

- 1" heavy gauge steel construction for improved stability
- Attractive white powder coat finish provides secure handgripping surface and years of dependable use
- Stainless steel hardware included
- Retail display box
- Available in 5 different sizes, 12- 32" in length
- 1" diameter tubing, 1-1/2" from wall

- #1076 12" White Grab Bar
- #1077 16" White Grab Bar
- #1078 18" White Grab Bar
- #1079 24" White Grab Bar
- #1080 32" White Grab Bar



NEW!

### Safe-er-Grip™ Foot Rest

- Position at any height for shaving in the shower
- Angled for better balance
- Mounts directly on shower wall
- Easy installation

#1169 Safe-er-Grip™ Foot Rest



#1069

### Bath Step

NEW!

Stool holds 400 lbs. weight capacity

- 4" extra height from floor to help in and out of tub
- Extra wide 16" platform
- Textured slip-resistant top and rubberized feet to keep firmly in place
- Additional steps stack securely and - add extra 2" height

#1069 Bath Step



#1038

### Deluxe Hand-Held Shower

- Water spray features easy on/off valve with adjustable flow control
- Reinforced vinyl hose allows spray to reach all parts of user's body while bathing
- Easily attaches to standard 1/2" shower arm
- 54" hose length, with diverter valve
- Wall mounting bracket included

#1038 Deluxe Hand-Held Shower



#1084

### Tub Safety Bar

- Vinyl coated heavy gauge rust-resistant steel
- Strong one piece steel platform
- Provides stability and comfort getting in and out of bathtub
- Stainless steel locking mechanism with non-marking rubber pads
- Fits a variety of tubs with tool-free installation
- Overall height 19 1/2", clamp adjustment 3-7"
- One per carton

#1084 Tub Safety Bar



### Safety Treads

- Easy to apply
- Easy to clean
- Permanent
- Helps prevent dangerous slips and falls
- 20 pieces per package (3/4" x 8 1/2")

#1075 Safety Treads



White Vinyl

#1083

### Sure Grip Bath & Shower Mat

- Mildew resistant
- Anti-bacterial treated
- Sure grip safety cups
- Soft white vinyl comfort surface
- Machine washable

#1083 Sure Grip 15" x 35" Bath Mat

#1183 Sure Grip Shower Mat (22" x 22")

## Sure Suction Tub & Shower Assists



#1168



#1167

Our Best Sellers!

Now Available  
In New  
Larger Sizes  
16" Length  
&  
24" Length



#1067

Flip-up easy release tabs help make installation and removal a snap!

All Attractively Boxed

- #1067 Sure Suction Tub & Shower Bar, 12"
- #1167 Sure Suction Tub & Shower Bar, 16"
- #1124 Sure Suction Tub & Shower Bar, 24"
- #1168 Traveler Sure Suction Tub & Shower Bar, 4"

## Safe-er-Grip Swivel

NEW!



#1126

- Multi-positional "swivel" feature offers a wide range of positioning options
- Allows the user to enter a wet and slippery tub or shower safely and with confidence
- Flip-up easy release tabs for easy installation and removal

#1126 Safe-er-Grip Swivel, 26" in Length

See Page 16 - Safe-er-Grip Footrest

## TubRail Safe-er-Grip

- Raised rail design allows the user to enter a wet and slippery tub safely and with confidence
  - Flip-up easy release tabs for easy installation and removal
  - Suction cup design is easy to attach, remove or relocate
- Attractive Display Box**



#1184

#1184 Tubrail Safe-er-Grip (12-1/2"H, 14"L)

**NOTE: Units designed as a balancing assist, not for body weight!**

Easy installation and removal



## Corner Safe-er Grip

- Unique design spans corner of tub or shower
- Flip-up easy release tabs for easy installation and removal - (19" long)

#1125 Corner Safe-er-Grip

## Portable Easy Grip Shower Hose Holder

#1039 Portable Shower Hose Holder

- Easy grip portable shower holder
- Position shower head to any height desired
- Flip-up easy release tab



#1039



Touch the red Alert button to activate Alarm. Audible signal is loud enough for caregiver to hear outside of the bathroom.

Can be used as a portable alert.  
With 17" Neck Lanyard

Removes easily from the Grip Alert assist bar providing just one touch to seek assistance, anywhere in the home.

Totally Water Resistant • Attractively Boxed • Patent Pending • Made in China • (3AAA Batteries Not Included)

*Note - This unit is designed as a balancing assist, not for body weight.*

## Bath/Safety (#1140) Grip Alert™



*The One Touch  
Alert System & Suction Assist Bar*

Use for assistance, stability, and alerting a loved one when and where assistance is needed.



#1140 Grip Alert (9" Long)



Touch the red Alert button to activate Alarm. Audible signal is loud enough for caregiver to hear outside of the bathroom.

One Touch Alert-Pro System is portable and can be used in any room -- even outdoors!

Perfect for travel use too!

Carry with you or wear around your neck.

17" Neck Lanyard Included  
Patent Pending  
Made in China  
Individually boxed  
(3 AAA Batteries Not Included)



## Push Alert (#1141)



*The One Touch Alert-Pro System*

Use for alerting a loved one when and where you need help.

#1141 Push Alert (1-3/4" x 5")



## Super Grip Suction Bar

**Chrome Finish**

- Ultra strong seal
- Mount vertically or horizontally
- No tools required
- Red and green color indicators
- Attractive retail display card
- 11.8"L x 3.9"W x 3.5"H

#1142 Super Grip Suction Bar



**Deluxe Alternating Pressure Pump & Pad** #7000

HCPCS E0181

- High capacity output 8.0 liters
- Adjustable Pressure range 50-105 mmhg
- Cycle time 5 minutes
- 10 ft. power cord
- On/off switch
- Built in bed mount hooks

**#7000 Deluxe Alternating Pressure Pump & Pad**

**NEW! Sit-N-Stroll Deluxe Foot Exerciser**



- LCD displays steps taken, calories burned and time spent exercising
  - Roomy, slip-resistant foot plates
  - Easy-adjust tension
  - 5 lbs.
- #2011 Sit-N-Stroll Deluxe Foot Exerciser**



HCPCS A4640

#7001

**Alternating Pressure Pads**

- Heavy duty 16 gauge PVC
- 2 1/2" height (inflated)
- 78" x 34"
- End flaps secure pad under mattress
- 130 interlocking bubble cells
- Air exchanged every 5 minutes

**#7001 APP Pads**



#3154

**Wheelchair Lap Tray**

- Uniquely designed to rest securely on the lap to hold beverages and food.
- Made of sturdy wipe-clean molded plastic
- Tray measures 16-1/2" L X 7-1/2" W
- End-Pockets comfortably hugs the legs

**#3154 Wheelchair Lap Tray**

U.S. Patent #376928 (Made in USA)



#3156

**Rigid Plastic Bed Tray**

- Perfect surface for eating, writing or reading
- Two side storage compartments
- Easy clean - durable plastic
- Tray surface: 13-1/2" x 10-1/2"
- Overall: 23" x 11-3/4" x 8"
- Tray height: 8"
- Attractive ivory color

**#3156 Plastic Bed Tray**

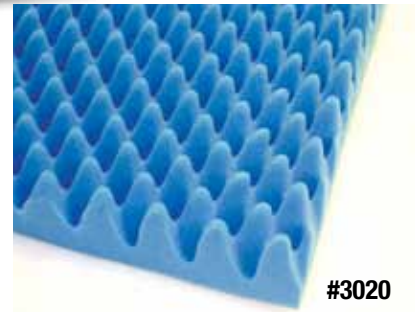

#3020

**Convuluted Foam Bed Pads**

- Medical grade foam – shrink wrapped
- Meets CA. #117 fire requirements
- Designed for comfort and air flow

HCPCS E0199

**#3020 Convuluted Foam Bed Pad 33" x 72" x 2"**

**#3023 Convuluted Foam Bed Pad 33" x 72" x 3"**

**#3024 Convuluted Foam Bed Pad 33" x 72" x 4"**

**#3021 (Full) 53" x 75" x 2-1/2"**

**#3022 (Queen) 59" x 79" x 2-1/2"**

**#3028 (King) 75" x 79" x 2-1/2"**



#2030



**Rose Uplift Seat Assist**

**With Extra Fleece Cover\***

- Self-power pneumatic cushion for use on any chair or sofa
- Assists with gentle up or down motion
- Completely portable with carry handle
- Strong enough to lift up to 80% of patient's weight
- Navy removable washable cover

**\*#2030 Rose Uplift Seat Lifter (80-230 lbs.)**

**\*#2032 Rose Uplift Seat Lifter (195-350 lbs.)**

**\*#2032P Rose Electrical Power Seat Assist (300 lbs.)**

HCPCS E0629

HCPCS E0628

**#2030E Rose Easy Economy\*\* Seat Lifter (80-220 lbs.)**

**#2032E Rose Easy Economy\*\* Seat Lifter (185-340 lbs.)**

\*\*NOTE: NOT COVERED BY MEDICARE

**#2032F Fleece cover for uplift seat**

**ALL NEW!**

HCPCS  
E0156

HCPCS  
E0143



#9001BL

**400 LB**  
WEIGHT CAPACITY

### Heavy Duty/Bariatric Rollator

- Soft Foam Grips with patented loop braking system
- 18" padded seat for comfort
- 21.5" between handles
- 8" tires and comfortable backrest
- Foldable for easy storage and transport
- Includes basket for storage
- Weight: 20 pounds

#9001BL Blue (1 Per Ctn.)  
#9001BG Burgundy (1 Per Ctn.)

HCPCS  
E0105



#9010

#9011

### Heavy Duty Steel Base Quad Canes

- Lightweight, extra strong base
- With 1" aluminum tubing, steel base
- comfortable vinyl, contoured hand grips
- Easy-to-use, one button height adjustment from 30" - 39"

#9010 Small Base, Vinyl Contoured Hand Grip, Chrome Cane (2 Per Ctn.)  
#9011 Large Base, Vinyl Contoured Hand Grip, Chrome Cane (2 Per Ctn.)

**300 LB**  
WEIGHT CAPACITY



#9005

**500 LB**  
WEIGHT CAPACITY

### Oversized Aluminum Folding Walker Two Button

HCPCS  
E0148

- Wider and deeper frame design accommodates individuals up to 500 lbs.
- Vinyl contoured hand grip
- Precision design provides additional strength while adding minimal weight

#9005 Oversized Aluminum Walker (2 Per Ctn.)  
#9000 Bariatric Walker with twin front wheels (2 Per Ctn.)

**NEW!**

- Width (Inside Hand Grip) 20"
- Width (Inside Back Legs) 25"
- Overall Width 28"
- Depth (Open at Base) 21"
- Height (Highest Setting) 39"
- Height (Lowest Setting) 32"
- Product Weight 7.0 lbs

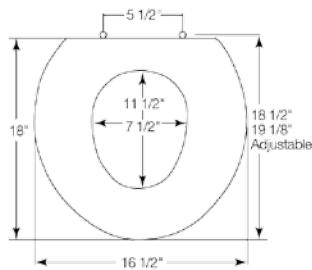

HCPCS  
E0100

#9015

**500 LB**  
WEIGHT CAPACITY



### Heavy Duty Offset Handle Canes

- Comfortable vinyl hand grip with wrist strap
- Manufactured with 1" steel tubing
- Dual push button release allows for handle height to be adjusted

#9015 (Adult) Black, Adjusts from 27 3/4" - 36 3/4"

HCPCS  
E155

#9006

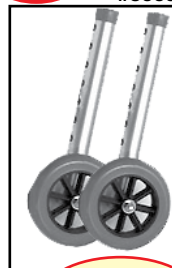

**500 LB**  
WEIGHT CAPACITY

### Bariatric Heavy Duty Walker Wheels with Glide Caps

5" Heavy Duty Wheels, Gray Wheels, 1pr/bx

- Converts heavy duty walker into wheeled walker
- Allows for 8 height adjustments
- Dual, rubber wheels allows walker to roll easily and smoothly over irregular surfaces

#9006 Bariatric Heavy Duty Walker Wheels

**NEW!**



**500 LB**  
WEIGHT CAPACITY

### Bariatric Oversized Toilet Seat

- Fits either standard or elongated toilet bowls
- 1 1/2" wider in diameter than regular sized units
- Fits snugly; seat opening same as standard unit, however, outside diameter is bigger
- Made of sturdy, easy-to-clean white polypropylene
- Closed front with cover, fits all toilet bowls

#9035 Bariatric Oversized Toilet Seat

\*See page 9 for Heavy Duty Transfer Boards

**NEW!**

### Universal Car Seat Belt Extender



#### Comfort & Safety

- Adjusts to add 12" to length
- Shoulder restraints remain intact
- Meets Federal Motor Vehicle Standards (FMVSS) #209 & #302 approved
- Black or Gray

#1011 Universal Car Seat Belt Extender

**ALL NEW!**



HCPCS  
E0168

# 9021

**650 LB**  
WEIGHT CAPACITY

**Deluxe Bariatric Drop Arm Commode**

- Features independent drop arms for easy transfers
- Durable steel construction supports 650 lb.
- Complete with seat, lid, bucket and cover
- Seat size 18" x 23"
- Adjusts 27" x 32"
- Width between arms, 23"
- One per carton - 25 lbs.

#9021 Deluxe Bariatric Drop Arm Commode



**500 LB**  
WEIGHT CAPACITY

#9032

**Padded Swivel Seat Cushion with Carry Strap**

- Helps prevent back and hip strain
- Designed for a car or chair
- Soft 1" foam padded seat
- Rotates 360 degrees in either direction
- Available in gray velour or fleece top

#9032 Bariatric Swivel Seat Cushion  
#9032F Bariatric Swivel Seat Cushion with Fleece Top

HCPCS  
E0248



#9058

**600 LB**  
WEIGHT CAPACITY

**Deluxe Heavy Duty Bath Bench with Dual Frame Brace**

- Manufactured with 1" Aluminum tubing
- Frame has width/depth cross braces attached with aircraft type rivets
- Large 16" seat depth
- Durable, blow molded plastic bench
- Drainage holes reduce slipping
- Extra middle legs for added strength

#9058 Bath Bench Without Back  
#9059 Bath Bench With Back

	#9058	#9059
Width (Outside Legs)	21"	21"
Seat Width	17.25"	17.25"
Depth (Outside Legs)	18.75"	18.75"
Seat Depth	16"	16"
Seat (Height Highest)	19"	19"
Seat (Height Lowest)	17"	17"
Product Weight	8.5 lbs	10 lbs



**500 LB**  
WEIGHT CAPACITY

# 9080

8-1/4"

**Extra Wide Folding Step Stool**

**NEW!**

- Extra large 19" x 14-1/2" Platform
- Anti-tip design for stability and support
- Folds flat - 2-1/2" for easy transport and storage
- Special non-slip gripper strips
- Sturdy steel construction - 11 lbs.
- 500 pound weight capacity

#9080 Extra Wide Folding Step Stool  
#9080HR Extra Wide Folding Step Stool with Handrail (16" W x 20" L x 38" H)

**NEW!**



**500 LB**  
WEIGHT CAPACITY

# 9004

9"

**Heavy Duty Foot Stool**

- Manufactured with 1" chrome plated steel tubing
- Non-skid ribbed rubber platform
- Cross brace attached with aircraft-type rivets
- 500 pound weight capacity

#9004 Heavy Duty Foot Stool

**Deluxe Heavy Duty Transfer Bench with Dual Frame Brace**



**400 LB**  
WEIGHT CAPACITY

#9057

HCPCS  
E0247

- 3 position back depth is adjustable from 18" - 19" in 1/2" increments
- Manufactured with 1" aluminum tubing
- Durable, blow molded plastic bench and backrest

#9057 Heavy Duty Transfer Bench (2 Per Ctn.)

Width (Outside Legs)	32"
Seat Width	27"
Depth (Outside Legs)	22.25"
Seat Depth	16"
Seat (Height Highest)	21"
Seat (Height Lowest)	16"
Product Weight	14 lbs
Carton Shipping Weight	33 lbs



**Foot Stool  
Foot Stool with Safety  
Support Hand Rail**

- Welded steel chrome plated construction
- Slip resistant ribbed rubber platform
- Reinforced rubber tips
- Platform; 10" x 14" Platform height; 9" Handle height; 34" Overall dimensions;
- 16" x 12" x 34"

**#2004 Foot Stool  
#2004HR Foot Stool  
with Hand Rail**



**Tote'n Bag  
Ergonomic Cart**

- Lightweight steel for durability (4 lbs.)
- Folds for compact storage
- Ergonomic comfort grip handle
- Water-resistant fabric - blue
- Open dimensions: 13" l x 14-1/2" w x 37" h

**#3240 Tote'n Bag  
Ergonomic Cart**



**Bedside Support Rail**

- Sturdy bedside rail supports you as you get into bed, then swings away from the bed for assistance.
- Ideal for those transferring from wheelchair to bed.
- Cushion on the top part of the handle for superior comfort.
- Adjusts in height to fit most beds - 32" tall.
- The handle is an oval shape for a perfect grip.
- Installs easily, just slip the steel frame between mattress and box spring and use the safety straps to anchor it securely.

**#2007 Bedside Support Rail**



**Adjustable Blanket  
Support**

- Attractive lightweight aluminum, bronze finish
- Support frame adjusts up to 23"
- Base inserts between boxspring and mattress (2 per carton)

**#3048 Adjustable Blanket Support**



**Folding Shopping Cart**

- Ideal for groceries and laundry
- Large 6" rear wheels and 3" front wheels
- Folds completely for easy storage
- Basket size; 12.5 x 10.5 x 20"
- Weight 9 lbs. weight capacity 100lbs

**#3102 Folding Shopping Cart**



**Universal Home or Hospital  
Slatted Bed Board**

- Made of specially designed hardwood slats
- Designed for hospital and home beds
- Folds completely for easy storage
- 30" x 60" overall size, 11 lbs.

**#2052 Universal Slatted Bed Board**

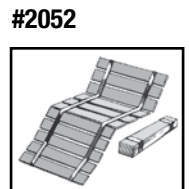

**#2055**

**Economy Folding Bed Board**

- Four-fold portable bed boards 4 x 15"
- Sturdy 7-ply Aircel board construction
- Attractive blue finish – easy to clean

**#2055 Economy Folding Bed Board  
30 x 60"**

**Wheelchair Transport Bags**

(Size 42" x 14" x 35")  
100 per roll

**#5038 Wheelchair Transport Bags**





**Universal Deluxe Sitz Bath \***

- Heavy weight
- 4" x 14 3/4" x 14 3/4"
- On/off flowclip
- Washable

**#3080 Universal Deluxe Sitz Bath (10 per case)**



**Fracture Bed Pan or Female Urinal \***

- Measurements in cc and ounces
- F-3" B-1" x 12 1/2" x 9 1/2"

**#3084 Fracture Bed Pan or Female Urinal (10 per case)**



**Stackable Bed Pan \***

- Stacks easily with grip handles.
- Measurements in cc & ounces
- F-4" B-2" x 14 1/2" x 12"

**#3082 Stackable Bed Pan (10 per case)**



**Bariatric Bed Pan with Cover**

- 350 lb. weight capacity.

**#3083 Bariatric Bed Pan with Cover**



**#3083**



**Individual Poly Bag with Headers - Retail Pack**

Following units available in retail package of 10.

#3080, 3084, 3082, 3083, 3086, 3088 - use letter R to denote retail package

**\*Plasticware for Homecare 10 per case Shrink-Wrapped\***



**Female Urinal with Handle**

- Uniquely designed for ease of use
- Comes with easy-grip handle
- 1-quart capacity
- Provides visual measurement of contents in ounces or cc's

**#3085 Female Urinal (1)**



**Unisex Portable Urinal**

- Unbreakable polyurethane
- Ideal for bedridden, handicapped and traveling
- Screw-tight lid and female spill-proof adapter
- Holds 28 oz. - 10" long

**#3046 Unisex Portable Urinal (1)**



**Female & Male Urinal \***

- Clear plastic translucent finish
- Easy grip handles
- 35 oz. capacity (female), 32 oz. male
- Measurement in cc & ounces

**#3086 Female (10 per case)**

**#3088 Male (10 per case)**



**Unisex Portable Urinal**

- Unbreakable white polyurethane
- Easy grip handle
- Flip lid and female adapter
- Holds 28 oz - 800 cc

**#3146 Unisex Portable Urinal (1)**

**#3087 Universal Carry Bag for Male/Female Urinals (7-1/2" x 13-1/2")**

**Available in Navy, Fancy Red, Fancy Black**



#3000

### Fleece Decubitus Bed Pads

- Comfortable, machine washable
- Helps provide better patient care
- Five sizes to choose from
- 100% polyester fiber

HCPCS  
E0189

#2998 15" x 18"

#2999 36" x 80" w/ elastic corner strap

#3000 24" x 30"

#3002 30" x 40"

#3006 30" x 60"

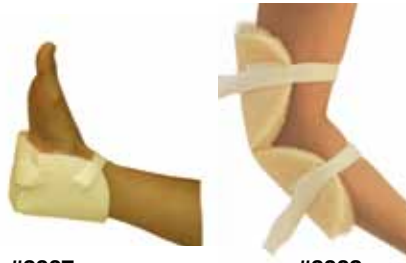

#3007

#3008

### Heel & Elbow Fleece Pads

- Soft plush protectors
- Hook & loop closures
- One size fits all
- Machine washable

HCPCS  
E0191

#3007 Heel Protectors

#3008 Elbow Protectors



#3012-60

### Gait Belt

HCPCS  
E0978

- Safe ambulation
- Quick release plastic buckle
- Easy grip for guiding patients
- Available in 60" or 72" lengths

#3012-60 Gait Belt 60" Standard

#3012-72 Gait Belt 72" X-Large



#3103-2

### Expanding Doorhinge

- Adds two inches to most any doorway
- Installs easily
- Uses same screws and holes
- Ideal for narrow bathroom doors

#3103-2 Expanding Doorhinge 2 per box

#3103-3 Expanding Doorhinge 3 per box



#4036

#4034

### Bed and Chair Riser

- Sturdy 4" or 6" black high density molded plastic with 500 lbs weight capacity
- Elevate head of the bed, increase storage under the bed
- Raises bed height by 4" or 6"
- Can be used on beds, tables or chairs

#4034 Bed and Chair Riser (two - 4" units)

#4036 Bed and Chair Riser (two - 6" units)



#3109



#3108

### Emergency Call Bells

- Available in a easy to use table top version or wooden handle version
- Ideal for use in bed or bath in case of emergency cases

#3108 Round Call Bell

#3109 Long Handled Call Bell



NEW!

### Deluxe Gait Belt

Support - Stability - Ease of Transfer

- Adjustable - 28"-52"
- Heavy duty nylon straps provide variety of holding positions
- Quick release seat belt buckle
- Hand washable
- 4" high back design

#3030 Deluxe Gait Belt



NEW!



FANCY RED  
- FRD



FANCY BLACK  
- FBK

### Heel Comfort Pillow

#3016

- Helps prevent and heal decubitus ulcers
- Unique fiberfill is resilient for support and comfort
- One size fits all with hook and loop closure
- Completely washable polyester/cotton cover
- Available in Blue, Fancy Black and Fancy Red

#3016 Heel Comfort Pillow



### Deluxe Aluminum Reacher

#2025

- Easy grip plastic handle
- Lightweight aluminum shaft
- Magnetic tip

#2025-32 Deluxe Aluminum Reacher (32")

#2025-26 Deluxe Aluminum Reacher (26")

### Easy Reacher

- Lightweight – easy to use
- Rubber cups hold large items up to 3 pounds
- Handy hook and loop hang tag
- Ideal for arthritic hands

#2026 Easy Reacher (Red) (31")

#2027 Easy Reacher (Blue) (31")



#2026

#2027

**NEW!**

### Super Long 36" Reacher with Rotating Jaw

- New ergonomic handle design reduces hand and finger stress
- New safety locking feature
- Strong anodized aluminum and stainless steel construction
- Heavy duty rubber cup grippers



#2017-36

**NEW!**

**NEW!**

Magnets

Claw Rotates Horizontally or Vertically



### Dressing Stick

- 27" long and a strong 5/8" diameter hardwood dowel
- Ideal for persons with limited upper extremity movement or decreased hip flexion
- Vinyl coated push-pull hook on one end and a small "C" pull hook on the other

#3117 Dressing Stick



#3117

### Shoe Horn/Dressing Aid

- 30" long dressing aid with soft foam handle
- Easy to use eliminates bending and stretching

#2028 Shoe Horn/Dressing Aid

Extend your reach nearly 3 feet!

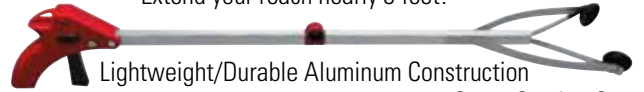

Lightweight/Durable Aluminum Construction

Super Suction Cups

Trigger Lock

#2021



Folds for easy storage

### "Rosie" the Folding Reacher Deluxe Folding Reacher

- Folds in half
- Locking mechanism
- Suction grips

#2021 "Rosie" the Folding Reacher

### Economy Stainless Steel Reacher

- Light weight - less than half pound
- Unique plastic gripper

#2024-32 Economy Stainless Steel Reacher



#2024-32

### Ergonomic Reacher with Rotating Claw (18" or 27")

- Lightweight and easy to use ergonomic handle
- Claw rotates 360° with 3-1/2" opening
- Magnet on handle to pick up smaller objects (1130 - 18 & 27)

#1130-18 Ergonomic Reacher, 18"

#1130-27 Ergonomic Reacher, 27"

#1136-31DZ Special Ergonomic Reacher, 31"

**NEW!**

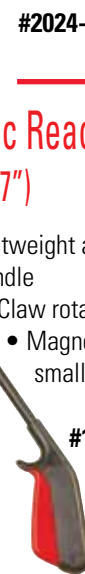

### Magnetic Pick-Up Reacher

- Heavy duty, picks up to 8 lbs.
- Telescopes 6-1/2" - 26"
- Soft comfort grip
- Handy pocket clip

#2134 Magnetic Pick-Up Reacher



#2028



#3041

## Universal No Bend Stocking and Sock Aid

- Rounded edges to prevent snags
- Built in hinges
- Easy glide strips to help your foot slide into sock or stocking
- Built in shoe horn

#3041 Universal Stocking and Sock Aid



## Sock Aid with Handles

- Easy grip handles
- Flexible plastic core
- Latex Free

#3044 Sock Aid with Handles

## Molded Sock-Stocking Aid



#3052

- Unique design holds easily
- Inside nylon reduces friction
- Outside terrycloth holds easily
- Two long loop handles
- Hand Washable

#3052 Premium Molded Stocking Aid (28" L)



#3032

## Easy Leg Lifter/Exerciser

- Aid device to lift feet and legs onto foot rest or into automobiles, beds or foot rest
- Use upper body strength to lift feet and legs
- Perfect for those recovering from hip surgery
- Durable woven nylon with rigid contour and loops at both ends
- Extra hand loop midway for better grip

#3032 Easy Leg Lifter 41" x 1"



#3038

## Deluxe Velour Stocking Pull-On

- Velour and nylon covered plastic core
- Easy pull-on loop handles

#3038 Deluxe Velour Stocking Pull-On



## Easy Pull Hosiery Aid

- Unique design can be used for compression hosiery, socks, panty hose, etc.
- Place hosiery over contour column and insert foot - pull up on handles
- Sturdy, smooth plastic coating over steel

#3148 Easy Pull Hosiery Aid



## No-Bend Foot Socker

- Easy to use (18"L x 5"W x 2 1/2"H)
- Slip sock over contoured plastic, slip foot into opening

#3143 No-Bend Foot Socker



#2080

#2081

#2082

## Stretchable Elastic Shoe Laces

- Eliminates need to tie
- Easy to slip on/off shoes
- 30" - fits 3-5 hole shoes
- Six pair per package

#2080 Elastic Shoe Laces Black  
 #2081 Elastic Shoe Laces Brown  
 #2082 Elastic Shoe Laces White  
 #2080VP Variety Pack, 2 Pr. of Brown, Black and White



#3119

## Coiler Shoe Laces

- Eliminates the need of tying shoelaces
- Once Coiler Shoe Laces are laced, the excess coiled loops maintain the desired tension
- Fits all shoe sizes
- 54" long

#3119W Coiler Shoe Laces (white)  
 #3119B Coiler Shoe Laces (black)  
 #3119BR Coiler Shoe Laces (brown)



**Reachers • Sock-Stocking Aids • Bath Sponge • Shoe Horns • Dressing Sticks**

**Hip/Knee Kits**

- Includes all the items needed to recuperate from knee or hip surgery
- Eliminate bending and reaching during recovery period

**Private Label Customized Kits Available**

- #2029 (2021, 3041, 3027, 2033, 3117)
- #2029A (2021, 3041, 3027, 3118-16, 3117)
- #2029B (2025-32, 3041, 3026, 2033, 3117)
- #2029C (2025-32, 3052, 3026, 2033, 3117)
- #2029D (2024-32, 3041, 3027, 3118-16, 3117)
- #2029E (2025-32, 3117, 3118-23, 3027, 3044)
- #2029F (3041, 3026, 2024-32, 3117, 3118-16)
- #2029G (3117, 3044, 3115, 2025-32, 2080, 3027)
- #2029H (3041, 2021, 3117, 3118-23, 3027)

(Note: Changes can be made based on requirements)  
Elastic shoe laces, page 26, can be added



#3115

**Easy Slider Shoehorn**

The Coated surface makes it easy for the foot to slide into the shoe, and the textured grip handle is easy to grasp. Coated steel. Length is 24".

#3115 Easy Slider Shoehorn



#2033

**No Bend Shoe Horn**

- 24" long flexible shaft
- Easy grip handle

#2033 No Bend Shoe Horn



#3116

**Extra Long Handled Shoehorn**

- Put on shoes without bending over, 24"
- Large, easy to hold and hang up
- Smooth epoxy coated steel for strength and durability

#3116 Extra Long Handled Shoehorn



#3118-23

#3118-16



**Plastic Shoehorns**

Plastic shoehorn with a curved hand grip for easier grasping. Length is 16" & 23". Assorted colors.

#3118-16 Plastic Shoehorn

#3118-23 Plastic Shoehorn



**Telescoping Shoe Horn**

- Extends 10" to 30"
- Angled shoe horn with wrist strap
- Perfect for traveling
- Stainless steel
- Comfort contoured grip

#2133 Telescoping Shoe Horn



#2025-32



#3117

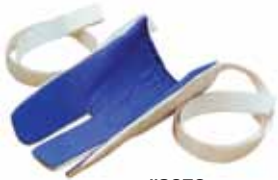

#3052

Item #2029-J



#2025-32



#3117



#3044

Item #2029-K



#2017-36



# 3027



#3115

Item #2029-L



#2025-32



#3115



# 3027



#3052

Item #2029-M



#2025-32



# 3027



#3044

Item #2029-N



#2025-32



# 3027



i2

Item #2029-O



#3032



#2025-32



# 3027



#3118-16



#3044

Item #2029-P



#2025-32



#3117



# 3027



#3115



#2080VP-1



#3044

Item #2029-Q



#2025-32



# 3027



#3117



#3118-16

# 3027



#3044

Item #2029-R



# 3034



### Lotion Applicator

- Easy fill applicator for lotion or gel
- 19 floating balls helps spread lotion evenly
- Detachable handle for massage of arms and legs
- 3 1/2" diameter 17 1/2" long
- Retail display box

#3034 Body Lotion Applicator



#3051

### Inflatable Hair Shampoo-er

- Portable vinyl shampooer for bed use
- Inflatable ring acts as reservoir
- Plastic hose allows for drainage
- Folds flat for easy storage

#3051 Inflatable Hair Shampoo-er



#3150

### Hair Washing Tray and Spray Attachment

- Soft facing surrounds tray and neck opening
- Compact light weight plastic
- Slip resistant base with nylon strap (35 1/2")
- Drainage outlet
- Size 12 3/4" wide and 17 1/2" long
- Neck opening 4 1/2" wide

#3150 Hair Washing Tray and Spray Attachment  
#3150S Spray Attachment



#3058

### Inflatable Bed Shampoo-er

- Easy to use heavy-duty vinyl
- 28" wide, 24" long, 6" depth
- Stores flat when not in use

#3058 Deluxe Inflatable Bed Shampoo-er

### Handi-Pen Writer



For right or left hand use

- Takes most of the "shake" and muscle pain out of handling a pen
- One finger through the ring creates a solid grip and the ergonomically designed barrel provides a natural resting place for the writing finger
- Barrel fits snugly between the fingers, no pressure, no pain.

#3190 Handi Pen Writer  
#3190R Handi Pen Refills (2)



#3107

#3106

### Long Reach Brush & Comb

- Ideal for those with limited reach or mobility
- Unique grip, extra soft and comfortable to hold

#3106 Long Reach Comb  
#3107 Long Reach Brush  
#3107S Comb & Brush Set

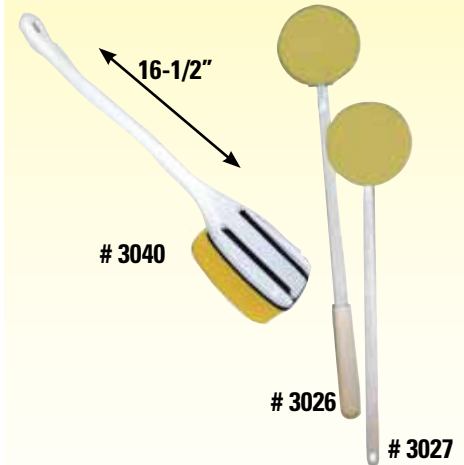

# 3040

# 3026

# 3027

### Long Handled Back Sponges

- Ideal for those with limited reach or mobility
- Makes bath easier for caregiver and patient
- #3040 Features Soap Holder

#3040 Back Sponge w/Soap Holder  
16 1/2" long  
#3042 Curved Handle Back Sponge  
w/Soap Holder 16 1/2" long  
#3026 Extra wide Bendable Ergonomic  
Handle  
#3027 Back Sponge 22" long



#5018

### Vinyl Meal Time Protector

- 100% vinyl provides total protection from spills and meal time mishaps
- Hook and loop closure
- size 16 1/2" x 35 1/2"

#5018 Vinyl Meal Time Protector, Each  
#5018D Vinyl Meal Time Protector, Dozen



#5019

### Terry Bib with Moisture Barrier

- Comfortable to wear
- Attractive blue terry cloth 18" x 30"
- Large moisture 12" x 17" barrier provides complete protection
- Easy to use hook and loop closure

#5019 Terry Bib/ Moisture Barrier, Each  
#5019D Terry Bib/ Moisture Barrier, Dozen



#5016

### Patient Protector with Crumb Catcher



- Easy on/off with tie back
- Made of absorbent, durable, white terry cloth face
- Crumb catcher style features a front pouch and waterproof vinyl backing
- Machine washable
- Approximate size: 17-3/4" x 26-1/2"

#5016 Patient Protectors with Crumb Catcher



#5015

### Smoker's Apron



- Flame retardant fabric
- Prevents accidental ignition of clothing while smoking
- Lightweight and comfortable material
- One size fits all
- White (30" x 34")

#5015 Smoker's Apron

### Clothing Protectors



Red - RD

- Full coverage - secures with hook & loop closure at neck
- Waterproof inner barrier with attractive poly/cotton outer
- Size 36" L x 17-3/4" W

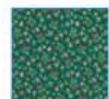

Green - GRN

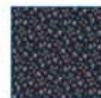

Navy - NV

Specify red, navy, or green

#5011RD,  
#5011NV,  
#5011GRN



### Adult Disposable Bibs

- Size: 16" x 33" - Ply Tissue/Poly
- Slip-on with ties
- Packed 100 per polybag

#5017 Bibs (with tie back)



#5012

### Rose Disposable Clothing Protectors

No Ties! Simply Peel & Stick!  
Waterproof, Lightweight, & Comfortable.

- With Fold-Out Crumb Catcher
- Polyurethane Backing
- Display Box - 50 per box
- 13 in x 18 in (33cm x 45.7 cm)

#5012 Disposable Clothing Protectors





## Soft Handled Cutlery

Soft handled, stainless steel utensils have large grips made of closed cell foam which will not absorb moisture. Ideal for people with arthritis or tender hands and finger joints. Foam grip slides off for easy cleaning. Lightweight, dishwasher safe.

- #3200 - Soft Handled Knife
- #3201 - Soft Handled Fork
- #3202 - Soft Handled Teaspoon

- #3203 - Soft Handled Soupspoon (not shown)
- #3204 - Deal Pack One of Each Above



## Weighted Cutlery

Our comfort grip weighted, stainless steel cutlery weighs 8 oz (226 grams) which decreases hand tremors, allowing cutlery to reach the users mouth easier. An ideal solution for persons with Parkinson's or other impairments resulting in hand tremors. Latex free. Home dishwasher safe.

- #3210 - Weighted Knife
- #3211 - Weighted Fork
- #3212 - Weighted Teaspoon

- #3213 - Weighted Soupspoon
- #3214 - Deal Pack One of Each Above



#3137

## Ring Pull Can Opener

- Universal design opens most any bottle or jar with ease - 8-1/2" long
- Ideal for those with limited hand strength
- Dishwasher safe

#3137 Ring Pull Can Opener



#3037

## Plastic Food Bumpers

- This sanitary snap-on food bumper is molded in one piece
- Institutional Dishwasher safe
- Fits 8"-11" (20-28cm) plates
- Microwavable
- Adapts a standard plate into a self-feeding plate

#3037 Plastic Food Bumpers



#3110

## Framed Page Magnifier

- Enlarges entire page 4X
- Ideal for reading telephone books, instruction sheets and important documents
- Unbreakable frame and wafer thin lens
- Easy to store and use
- Size: 7 1/2" x 11 3/4"

#3110 Framed Page Magnifier



#3132

## Illuminated Bifocal Magnifier

- Features a 3" acrylic lens with 3X magnification and a bifocal insert with 5X magnification
- Requires 2 AA batteries (not included)

#3132 Illuminated Bifocal Magnifier



#3131

## Illuminated Magnifier

- 5X magnification
- Illuminates while magnifying
- Hands free design
- Requires 2AA batteries (not included)

#3131 Illuminated Magnifier



#3033

## Two In One Utensil

- Ideal for those with use of one hand
- Dual knife & fork
- Dishwasher safe

#3033 Two In One Utensil



#3158

## Universal Grip Turner

PERFECT FOR THOSE WITH LIMITED HAND DEXTERITY

- Fits over knobs, keys, faucets and odd shaped handles
- Easy grip handle
- Durable plastic with steel prongs

#3158 Universal Grip Turner



## Scoop Plate

- Promotes independence at meal time
- Allows user to push food against high back wall
- Entry side is low for easy use
- Skid resistant base
- Breakproof and microwavable plastic

#3136 White 9" Scoop Plate

### Recliner Lever Extender



**NEW!**

#3189

- Slides easily onto handle
- Provides 8" extension to existing handle
- Easy to push back and forward
- Lightweight plastic with soft fabric cover

#3189 Recliner Lever Extender



### Double Handled Mug

- Ideal for those with a weak grasp or a tremor
- Large handles to accommodate adult fingers
- Wide base to resist tipping
- Dishwasher safe up to 194 F (90 C)
- Lid with mouth piece included

#3035 Double Handled Mug



#3036

### No Spill Cup

- Features a lid with a mouth piece
- A small air inlet hole in the lid, allows user to regulate the flow of the liquid
- 8oz (235 ml) capacity
- Ideal for drinking while lying in bed

#3036 Convalescent No Spill Cup



### Easy Grip Cup

- Unique ergonomic design
- Microwave and dishwasher safe
- Suitable for hot or cold food
- Autoclavable clear polypropylene
- Holds 12 ounces

#3029 Easy Grip Cup



#1160

### A.D.L. Cuff

- Adaptive pocket for everyday utensils
- 1" (25 mm) wide white nylon webbing with hook and loop closure
- For people with hand weakness paralysis but good wrist control

#1160 A.D.L. Cuff



**NEW!**

### Food Preparation Board

- Unique design holds in place with curved lip and no-slip feet
- Raised rear lip prevents slip-off
- Hygienic ABS plastic surface
- 8-3/4" x 8-3/4"

#3220 Food Board



#3134

### Universal Button Hook/Zipper Aid

- Can be used with large and small buttons
- 5/8" diameter - polyurethane stained handle
- Easy to use zipper pull

#3134 Universal Button Hook/Zipper Aid



# 3121

# 3122

### English Style Ice Bags

- Wide mouth accommodates even large ice cubes
- Heavy duty with leak proof cap
- Flexible design for easy application

#3120 6"

#3121 9"

#3122 11"



### Magnifying Medi-Cap Remover

**NEW!**

- Built-in magnifier (4X)
- Easy Grip for Smooth or Rigid Caps
- Opens child proof bottles

#3133

### Power Putty Hand/Finger Strengthening System

- Flexible silicone rubber can be squeezed, stretched and pulled
- Helps relieve stress and tension
- Recommended by physicians, therapists and sports trainers
- Complete with exercise instructions

#3151M Power Putty (Medium, 3 oz.) (Green)

#3151F Power Putty (Firm, 3 oz.) (Blue)



**NEW!**

## "Easy Open It" – 4-in-1 Opener

Opens Pill Bottles and Medicine Packaging

- Ideal for arthritic or weakened hands



#3138

Soft grip for those with arthritis.



**NEW!**

Slide lock cap provides safety when not in use and locks in place during use.

Individually Carded - 6 Units  
#3138-DP 6 Pack #3138

Metal blade easily punctures and removes foil backing on single or double vacuum sealed packs.



## Kitchen Gripper

**NEW!**

Effortlessly opens any stubborn lid

- Adjustable size jar and bottle opener
- Easy to use dial for most cans or jar lids (from 25-100 mm)
- Built-in pop-top bottle opener
- Extra long handle for extra leverage.

#3139 Kitchen Gripper

## Motion Sensor Light



- Lights automatically, no outlet required
- Detects motion up to 10 feet
- Four ultra bright LEDs
- Auto off after 20 seconds
- Mounts easily with peel and stick adhesive
- Lasts 100,000 hours
- Uses 3AAA batteries, not included
- 3-1/4" x 2-3/8"

**NEW!**

#3184 Motion Sensor Light

## Air Purifier/Night Light

Built-in ionizer cleans the air while your family sleeps!

- Uses ultra efficient LED technology
- It's an air purifier inside a night light
- Light turns on automatically in a darkened room
- Plugs into any outlet
- Lasts 35,000 hours - 2 year warranty



**NEW!**

#3182DP-Air Purifier/Night Light  
6 units

#3182-Air Purifier

## Talking Pedometer and Calorie Counter



- Announces how many steps and calories burned and time
- Large LED display
- Attaches to waistband or pocket
- 2-1/4" h, uses 2 button cell batteries, included

**NEW!**

#3180 Talking Pedometer



**NEW!**

#3145

## Handi-Exerciser

- Easy to use hand exerciser
- Strengthens each finger individually

- Ideal for arthritic hand exercises
- Improves dexterity and hand strength
- 4 pounds of resistance per finger
- Ergonomic design with non-slip finger and palm pads

#3145 Handi-Exerciser



## Portable Bidet & Washmate

**NEW!**

- Gentle form of personal hygiene
- Convenient size
- Simple to use
- 9" curved nozzle for longer reach
- Attractive retail box

#3142 Portable Bidet & Washmate

## Long Range Comfort Wipe

- Easy to use for personal hygiene
- Flexible hand grips toilet paper or pre-moistened wipes
- Release button for easy disposal
- Sturdy ABS plastic - 15" long

#3147 Long Range Comfort Wipe

#3147K Long Range Comfort Wipe plus cover



#3147

**NEW!**

Works with Toilet Paper and Pre-Moistened Wipes



#3111

### Hands Free Hair Stand

- Holds hair driers without the use of hands
- Flexible holder allows for any angle of adjustment while holding dryer securely
- Height adjusts up 34"
- Non-tip weighted stand

#3111 Hands Free Hair Stand



#3135W Women's Compression Gloves  
#3135M Men's Compression Gloves

### Compression Gloves

- Lightweight and open fingertips
- Unique combination of compression and special gripping nubs
- Helps ease arthritis pain, stiffness and circulation problems
- Cotton/Polyester/Spandex



### Foot Cleaning Brush

- 25" long, soft nylon bristles
- Comes with two sponge heads

#3039 Foot Cleaning Brush  
#3039SP 3 replacement sponges

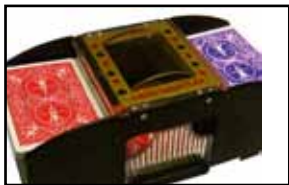

#3090

### Automatic Card Shuffler

- Simple to use – perfect for those with limited hand dexterity
- Holds up to 2 decks – heavy duty plastic
- Works on 2 C batteries (not included)

#3090 Automatic Card Shuffler



#3128

### Door Knob Gripper

- Stretch over a door knob to produce a soft ribbed surface
- Reduces strength required to open a door
- Can be used for outdoor water faucet handles and kitchen and bathroom taps

#3128 Door Knob Gripper



#3045

### Pill Cutter/Crusher

- Heavy duty plastic
- Stores pills, crushes them, and provides a drinking vessel

#3045 Pill Crusher & Cutter



#3092

### Easy See Playing Cards

- Extra large letters and numerals
- Standard size playing cards
- Plastic coated finish

#3092 Easy See Playing Cards



#3094

### Plastic Card Holders

- Holds up to 15 cards.
- Stand on table or hold in hand
- Organizes hands for easy playing

#3094 Playing Card Holder (set of 2)



#3096

### Wooden Card Holder

- Enjoy card playing with little effort
- Tiered slots – solid wood base
- Cards easy to see and remove

#3096 Card Holders (set of 2)

### Medi-Timer

- Lightweight, easily carried
- 2"x4" attractive box
- Battery included
- Stores capsules and tablets of any size
- Easy to use timer function

#3130 Medi-Timer



#3130

### Large Weekly Medication Planner



#3129

- Extra large planner has 28 pill compartments
- Each lid has raised letters and Braille identification
- Dishwasher safe, constructed of heavy-duty plastic
- Size: 8-3/8" x 5-5/8" x 1-1/8"

#3129 Large Weekly Medication Planner

## Lighted Magnifying Nail Clipper **NEW!**

- Easy to use 3X magnifier
- Bright LED light easy to see
- ABS plastic stainless steel clipper
- 3 button cell batteries included
- Attractive display card



Easy Empty Nail Clip Catcher  
Wide, Non-Slip Comfort Grips  
Wide Opening for Thick, Hard Nails

#3104 Lighted Magnifying Nail Clipper

## Massaging Shower Strap

- Stimulating nodules on one side and soft cleansing bristles on the other
- Attractive display box

#3149 Massaging Shower Strap



**NEW!**

Automatic shut-off

**NEW!**

## Electric Moist Heat Pad



HCPCS E0215

- Quick heat up - 4 heat settings
- Flexible pad with soft cover
- Moist comfort sponge
- 9-foot cord - 40 minute auto off
- Reusable storage bag

#3300 Electric Moist Heat Pad - Standard - 12" x 15"  
#3302 Electric Moist Heat Pad - Extra Large - 12" x 24"



Ideal For Wheelchair, Scooter or Car

## Handy Pocket Holder

- Perfect for cell phone, glasses, etc.
- Adhesive-back; ideal for wheelchair, scooter or car
- Soft, flexible, durable plastic
- 3" x 3 1/2" x 1 1/4"

#3124 Handy Pocket Holder

## Cell Phone Arm Band

Keeps phone handy and leaves your hands free!  
14-1/2" l x 4-1/4" w

- Zippered cell phone pocket
- Pocket for keys and cash
- Adjustable hook-and-loop closure



#2084



#2084 Cell Phone Arm Band



## TV Listener

Ideal for the Hearing Impaired



- Listen to TV without disturbing anyone else
- Volume control on deluxe cushioned lightweight stereo headphones
- No interference from other electronic devices
- Transmits signals up to 50 feet
- Infrared wireless technology
- Works with any TV or stereo
- Uses 2-AAA batteries, not included

#3140 TV Listener  
#3140H TV Listener-Extra Head Set

## Easy Hear Big Button Phone

- Soft-to-loud adjustable ringer
- Large, easy push buttons
- 6' phone cord
- Hearing aid compatible
- Wall mountable



#3126 Easy Hear Big Button Phone



## Wireless Headphones

Watch TV Without Disturbing Others

- Crystal clear reception up to 100 feet
- Soft comfortable ear pads
- Adjustable volume control
- Build-in FM Radio

#3141 Wireless Headphones

# Universal Auto Grip™ & Auto Grip with Flashlight

## New Secure Safety Design

Get in and out of your vehicle easily

#1150 Universal Auto Grip



- Attaches easily - insert securely into a u-shaped striker bracket
- Removes easily for storage
- Auto-Grip can then be used to assist getting in or out of car
- Non-Slip hand grip, heavy duty steel design
- Attractive blister card packaging

#1152 also features:

- 9 super, ultra bright LED bulbs included
- Requires 3-AAA batteries, not included

#1152 Universal Auto Grip and Flashlight



## Soft Swivel Seat Cushion

- Unique design enables easy transfer in and out of automobile
- Soft, comfortable top surface; anti-slip material on bottom
- Conforms to any car seat
- 16" diameter - 2 part cushion
- Weight bearing up to 350 lbs.
- Lightweight, portable

Navy or Camel Cover



#4130 Soft Swivel Seat Cushion



## Padded Swivel Seat Cushion with Carry Strap

- Helps prevent back and hip strain
- Designed for car or chair
- Soft 1" foam padded seat
- Rotates 360° in either direction
- Supports up to 300 lbs
- Gray velour or fleece cover

#4030 Swivel Seat Cushion



## Seat Belt Helper

- Attaches easily to any car seat
- Eliminates straining & discomfort
- Extends reach 6" for ease of use
- Made of flexible silicone

#1164 Seat Belt Helper

## The Car Handle

- Installs and removes in seconds
- Fits any framed car window
- Sturdy nylon construction
- Adjustable length (7"-16")
- No-slip rubber ergonomic contour grip



Never struggle to get out of the car again!



NEW!

## Auto Back Seat Hand Grips

- Hooks onto back of car headrest posts
- Compact
- Only 13" long
- Made of durable polyester filled PVC for strength and comfort.

#1163 Auto Back Seat Hand Grips

250 LB WEIGHT CAPACITY

NEW!

#1170





HCPCS  
L1902

### Elastic Ankle Support

- Designed to maximize compression and provide comfort
- Made of multi-stretch elastic - Biege
- Machine washable
- Features comfortable open-toe and heel
- Available in four sizes based on ankle circumference: S (6" - 8-1/2"), M (8-1/2" - 11"), L (11" - 13-1/2") XL (13-1/2" - 16")

#2070 S, #2070 M, #2070 L, #2070 XL



HCPCS  
L1825

### Elastic Knee Support

- Design allows for maximum compression and provides comfort and support
- Made of multi-stretch elastic - Biege
- Machine washable
- Available in four sizes based on knee circumference: S (12" - 15"), M (15" - 18"), L (18" - 21") XL (21" - 24")

#2071 S, #2071 M, #2071 L, #2071 XL



HCPCS  
L3999

### Elastic Elbow Support

- 8" long tubular knitted elastic slips on easily to provide compression
- Made of multi-stretch elastic - Biege
- Machine washable
- Available in four sizes based on elbow circumference: S (8.5" - 10"), M (10" - 11.5"), L (11.5" - 13"), XL (13" - 14.5")

#2073 S, #2073 M, #2073 L, #2073 XL



### Hot Water Bottle with Stopper

- Seamless rubber
- Leak proof
- Embossed surface
- Capacity: 2 Qts.

#3017 Hot Water Bottle with Stopper

# 3017

### Combination Water Bottle with Stopper



- Screw stopper/auto shut-off clamp
- Complete with vaginal/rectal pipes, hose and adapter

# 3018

#3018 Combination Water Bottle/Fountain Syringe



# 2065

### Posture Corrector Brace

- Improve posture and ease back strain
- Unique reinforced crisscross foam bands
- Adjustable Velcro® closure
- Contents 80% cotton, 20% Lycra®
- Sizes: S (30"-32"), M (34"-36"), M/L (38"x40"), L (42"-44"), XL (46"-48")
- Machine Washable

#2065 Posture Corrector Brace



# 2069

### Universal Posture & Clavicle Support

HCPCS  
L3660

- Soft cotton/flannel back panel and felt padded stockinette shoulder straps
- Front buckle closure makes support universal and allows easy self application
- Pliable metal stays are enclosed for added stability
- Lightweight and discreet under clothing
- Size: (One size fits all up to 44")

#2069 Universal Posture & Clavicle Support



28 Magnets

### Magnetic Lumbar Back Support

- Low back pain therapy
- 28 integrated high power magnets strategically placed in lumbar area
- Black neoprene with hook and loop closure
- Sizes Small - up to 30"; Medium - up to 38"; Large - up to 46"

#2061 Magnetic Lumbar Back Support

### Lister Bandage Scissors, Chrome-Plated

ITEM	SIZE
#3160	3-1/2"
#3161	4-1/2"
#3162	5-1/2"
#3163	7-1/4"



# 3160



### Chrome Plated Nail Nippers

- Coil spring and concave cutting edges

#3166 Chrome Plated Nail Nippers

HCPCS  
L0625



#2074

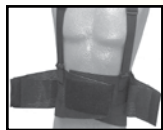

### Deluxe Industrial Safety Belt

- 8" breathable elastic, double 4 1/2" pull straps
  - 3 flexible metal stays for support and fit
  - Removable and adjustable shoulder strap
  - Completely washable
- Please specify size:  
 Small (28" - 33"), Medium (34" - 37")  
 Large (38" - 41"), X-Large (42" - 48")  
 XXLarge (50" - 54") XXXLarge (56" - 60")

#2074 Deluxe Industrial Safety Belt



#3043

### Patella Knee Strap

- Improves tracking of the knee cap and spreads pressure uniformly
  - Elevates the knee cap slightly which relieves harmful pressure
  - Hook and Loop closure, sized for perfect fit
- Please specify size  
 Small - 101/2" - 121/2"  
 Medium - 123/4" - 141/2"  
 Large - 143/4" - 161/2"  
 XLarge - 163/4" - 18"

#3043 Patella Knee Strap



HCPCS  
L0625

#2060

### Lumbar Support Belt With Foam Insert

- Extra support for lower back
- Removable foam insert
- Hook and loop closure
- Completely washable
- One size fits all (up to 48" waist)

#2060 Lumbar Support Belt With Foam Insert



#2075

### Tennis Elbow Splint

HCPCS  
E0189

- Helps relieve pain associated with tennis elbow
  - Aluminum bar immobilizes tendon and protects against shock
  - Foam padded vinyl bands
  - Hook and loop closure
- Please specify wrist size  
 XSmall; 5 3/4" - 6 1/4" Small; 6 1/4" - 6 3/4"  
 Medium; 6 3/4" - 7 1/2" Large; 7 1/2" - 8 1/4" XLarge; 8 1/4" - 9"

#2075 Tennis Elbow Splint

#2075D Tennis Elbow Splint 12 piece asst. contains 2-XS, 2-SM, 3-M, 3-L 2-XL



#2072

**NEW!**

### Universal Blue Neoprene Wrist Brace

- Ideal for sprains, carpal tunnel and arthritis
- Reversible for right or left hand
- Hook and loop closure
- Completely washable
- One size fits all

#2072 Neoprene Hand Wrap



### Deluxe Foam Cervical Collar

- Medium density, 1" thick foam collar
  - Covered in natural stockinette
  - Contoured design features chin cutout
  - Velcro-type closure
- Small: 12" - 14" (3")  
 Medium: 14" - 16" (3")  
 Large: 16" - 18" (3 1/2")  
 XLarge: 18" x 20" (3 1/2")

HCPCS  
L0120

#2067 Deluxe Foam Cervical Collar



#2068

### Universal Foam Collar

- Hook and loop closure
- One size fits all
- Available in 2", 3" or 4" widths

#2068 Universal Foam Collar

HCPCS  
L0120

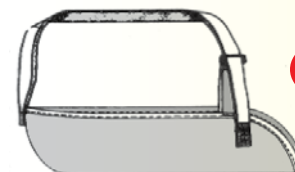

#2076

### Arm Slings

- Attractively Boxed or Bulk Pack
- #2076 Poly/cotton w/hook and loop closure (One size fits all)  
 #2077 Poly/cotton w/buckle closure (One size fits all)

HCPCS  
A4565



#2063

HCPCS  
L0210

#2064

### Universal Rib Belt

- Knitted elastic, 6" width, hook and loop closure
  - Soft loop material laminated to brush cotton
  - Completely washable,
  - One size fits all
  - Female Rib Belt has front contour
- #2063 Universal Rib Belt (Male)  
 #2064 Universal Rib Belt (Female)



## Molded Foam Ring Cushions & Memory Ring Cushions

- Made of a one piece molded foam
- Ring comfortably conforms to body contours
- Ideal for the relief of pain associated with coccyx injuries, hemorrhoids - helps prevent back and hip strain
- Designed to fit most any car seat or chair
- Removable, washable poly/cotton covers, available in three sizes

#4024 Molded Foam Ring 14"

#4025 Molded Foam Ring 16"

#4026 Molded Foam Ring 18"

### GEL RING CUSHIONS

#4026GEL 18" Ring with Gel Center **NEW!**

#4026GEL (Fleece Cover) 18" Ring with Gel Center **NEW!**

### MEMORY RING CUSHIONS **NEW!**

#4025MEM - 16"

#4026MEM - 18"

Please specify: White, Navy, Plaid or Fancy covers



FANCY RED  
- FRD



FANCY BLACK  
- FBK



TEARDROP  
RED - FTD



HCPCS  
E0190

MADE IN USA



#4022



#4020

Covers Available



### Inflatable Vinyl Ring

- Portable, easy to inflate vinyl ring
- Reduces pain associated with coccyx injuries
- Heat-sealed heavy gauge vinyl for durability

#4022 Inflatable Vinyl Ring 16"

### Red Rubber Ring

- Helps relieve pressure and fatigue for those required to sit extended periods
- Made of durable rubber with air release valve

#4020 Red Rubber Ring 16"

#4021 Red Rubber Ring 18"

#4020N Ring & Cover

#4021N Ring & Cover **NEW!**

#4020C Cover Only (Navy)

#4021C Cover Only (Navy)

### Convoluted Foam Ring Cushions\*

- Helps prevent back and hip strain
- Designed for car seat or chair
- PLEASE SPECIFY: WHITE, NAVY, PLAID, OR FANCY COVER (see above for samples)

#4027 Convoluted Foam Ring 16"

#4028 Convoluted Foam Ring 18"



#3078

HCPCS  
2611

All Foam Flame Retardent  
Meets Cal. 117

AVAILABLE IN  
NAVY, BURGUNDY,  
BLACK, GRAY, FLEECE WITH  
NAVY & 3 FANCY PRINTS!



### Deluxe Molded Foam Lumbar Cushion\*

- Molded foam for firm support
- Side "wings" provide extra support
- Removable poly/cotton cover with elastic strap included

#3078 Deluxe Molded Foam Lumbar Cushion 13" x 14"

#3078XL Extra Large Molded Foam Lumbar Cushion 13" x 18"\*

#3078F Molded Foam Cushion with Fleece Cover \*Navy, Black Only

#3079 Deluxe Molded Foam Lumbar Cushion Extra Firm with  
(Masonite®) Insert 13" x 14"



FANCY RED  
- FRD



FANCY BLACK  
- FBK



TEARDROP  
RED - FTD



#3078GEL

HCPCS  
2611

AVAILABLE IN  
NAVY, BURGUNDY,  
BLACK, GRAY &  
3 FANCY PRINTS!

### Deluxe Molded Foam GEL Lumbar Cushion\*

- 14" x 13"
  - Washable, removable cover
- #3078GEL GEL Lumbar Cushion



FANCY RED  
- FRD



FANCY BLACK  
- FBK



TEARDROP  
RED - FTD



#3078MEM

### Memory Foam Lumbar Back Cushion\*

- Removable, machine washable polyester/cotton cover
- Strap keeps cushion in position on most any chair or seat
- Heat sensitive memory foam custom contours and supports natural spinal curve

#3078MEM Memory Foam Lumbar  
Cushion 13" x 14"



FANCY RED  
- FRD



FANCY BLACK  
- FBK

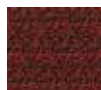

TEARDROP  
RED - FTD

VISCO ELASTIC FOAM DEVELOPED by NASA

HCPCS  
2611



E2611

### Fleece Wheelchair Back Cushion\*

- Fleece cover with foam insert
- Maximum comfort
- Provides 2 hang loops for positioning
- Improves air circulation
- Size: 18" x 20"

#4023F Fleece Wheelchair Back Cushion

#4023FM Fleece with Memory Foam Insert

CREATE  
YOUR OWN  
SUPER  
COMBO

Back and Seat  
Cushions

Perfect for all  
Wheelchairs

HCPCS  
2611

## Wheelchair Cushions - Standard Foam



#4014

- High density foam for seating comfort
- Fits all standard wheelchairs
- Removable and washable cover

HCPCS  
2601

- #4011 18" x 18" x 2" Navy Cover
- #4009 Plaid or Navy 16" x 16" x 2"
- #4014 Fancy, Plaid, Black or Navy 16" x 18" x 3"
- #4015 Plaid or Navy 16" x 16" x 3"
- #4016 Fancy, Plaid or Navy 16" x 18" x 2"
- #4017 Fleece Cover 16" x 18" x 2"
- #4029 Fancy, Plaid or Navy 16" x 18" x 4"
- #4015F 16" x 16" x 3" - Fleece Cover
- #4120 16" x 20" x 3" - Brushed Navy Cover
- #4122 16" x 22" x 3" - Brushed Navy Cover



#4018

### Convoluted Seat Cushion

- Ideal for home, office, car or wheelchair
- Allows for better air circulation to reduce heat build up to reduce the risk of developing decubitus ulcers
- Plaid, Navy, Black or Fancy Print removable, washable cover

- #4018 Convoluted Seat Cushion 3" x 16" x 18"
- #4019 Convoluted Seat Cushion 4" x 16" x 18"
- #3025 Convoluted Full Chair Pad (Foam Only) 18" x 32" x 3"



FANCY RED  
- FRD



FANCY BLACK  
- FBK



TEARDROP  
RED - FTD

AVAILABLE IN  
NAVY, PLAID, FLEECE &  
3 FANCY PRINTS!

HCPCS  
2602

All Foam Flame Retardant  
meets or exceeds CAL#117 requirements  
Made in USA



#4003

### Auto Seat & Wheelchair Sloping Wedge

- Unique design prevents user from sliding forward and helps promote proper posture
- Removable washable cover
- Size 16" x 18" x 3" to 1"

#4003 Wheelchair Sloping Wedge



#4001

### Sloping Coccyx Cushion

- Cushion Slopes 2" to help prevent sliding forward and helps promote proper posture
- Coccyx design removes pressure from coccyx area
- Removable, washable navy poly/cotton cover
- Size 16" x 18" x 3" to 1"

#4001 Sloping Coccyx Seat Cushion



#4005

### Coccyx Seat Cushion

- Unique design helps relief pressure on Coccyx Bone
- Removable, washable navy cover polyester/cotton cover
- 100% foam construction for total comfort
- Size 18" x 16" x 3"

#4005 Coccyx Seat Cushion  
#4005M Coccyx Comfort Cushion with  
Masonite® Board Insert

### Sloping Travel Cushion

- 15" x 14" x 3" to 1 1/2"
- Washable Navy Cover
- See 4101 for features, other than cut-out

#4102N Sloping Travel Cushion



NEW!

### Sloping Travel Coccyx Cushion

- 3" U-Shaped opening provides pressure relief for the coccyx tailbone area to help relieve lower back pain
- Constructed of highly resilient polyurethane foam for maximum comfort and durability
- Features a machine-washable, zippered cover with built-in carry handle
- Size 15" x 14" x 1-1/2"-3"
- Covers available in camel & navy
- Foam meets CAL #117 requirements

#4101C Camel Cover  
#4101N Navy Cover  
#4101 Waterproof Navy Cover

NEW!

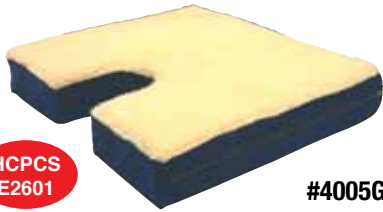

HCPCS E2601

#4005G

### Coccyx Gel Seat Cushion - 3 1/2" with Fleece Top

- Cut-out relieves pressure on spine
- 3" high density foam with gel pad in center
- Reduces pressure on tail bone and spine
- Washable, navy cover with fleece top
- Size: 16" x 18" x 3"

#4005G Coccyx Gel Seat Cushion  
#4005GN Coccyx Gel Cushion with All Navy Cover

### Bariatric Style

#4005GB 16" x 20" x 3 1/2" (Fleece Top)  
#4005GXL 16" x 22" x 3 1/2"

NEW! HCPCS E2604

## All Foam Flame Retardant

meets or exceeds CAL#117 requirements

Made in USA

### Gel Wheelchair Cushion with Fleece Top - 3 1/2"

- Gel and foam construction provide perfect weight distribution for maximum comfort while you sit

#3997 - 16" x 16" x 3 1/2" **NEW!**  
#3998WP 16" x 18" x 3 1/2" Waterproof Cover  
#3998G 16" x 18" x 3 1/2"  
#3998N 16" x 18" x 3 1/2" with All Navy Cover

### Bariatric Style

#3996 16" x 20" x 3 1/2" (Fleece Cover) **NEW!**  
#3998XL 16" x 22" x 3 1/2" (Fleece Cover)  
#3998XL-N 16" x 22" x 3 1/2" with full Navy Cover  
#3998XL-WP 16" x 22" x 3 1/2" with Navy Waterproof Cover



HCPCS 2601

#3998G

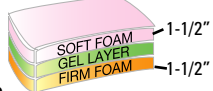

IDEAL POSITIONER AND SKIN PROTECTION

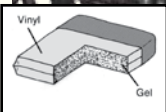

HCPCS E2601

#4012

### Pressure-Aid 100% Gel Cushions

- Total displacement of pressure
- Helps prevent decubitis problems
- Gel enclosed in heat-sealed heavy gauge vinyl plus cover

#4010 Navy Cover 16" x 18" x 2"  
#4012 Fleece Cover 16" x 18" x 2"  
#4013 Navy Cover 16" x 20" x 2"

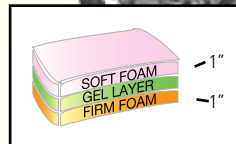

HCPCS 2601 2602

#4002

### Pressure-Aid Gel Cushions - 2-1/2"

- Total comfort with unique combination of gel and foam
- Reversible for soft or firm seat
- Gel sealed in heavy gauge poly bag

#4002 Navy Cover 16" x 18" x 2-1/2"  
#4004 Fleece Cover 16" x 18" x 2-1/2"  
#4006 Navy Cover 16" x 20" x 2-1/2"  
#4007 Fleece Cover 16" x 20" x 2-1/2"

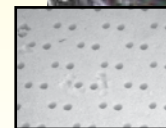

#3099

### Natural Pincore Latex Foam Cushion

- Ultra soft latex comfort and support
- Excellent recovery
- Pincore cushion allows for better air circulation
- Removable, washable poly/cotton cover
- Available in Navy, Black, Plaid or Fancy Print cover

#3099-3 Pincore Latex Foam Cushion 16" x 18" x 3"

#3099-4 Pincore Latex Foam Cushion 16" x 18" x 4"



FANCY RED - FRD



FANCY BLACK - FBK



TEARDROP RED - FTD

### Prostate Cushion

- Unique design to relieve pressure on perineal area
- Comfort plus relief
- Washable brush navy cover
- Foam meets Cal#117 requirement



#3178 Prostate Cushion (16" x 18" x 3") **MADE IN USA**



**Comfort Plus Protection**  
**MADE IN USA**

### Waterproof/Anti-Bacterial Wheelchair Cushions

- Treated foam meets CAL #117 requirements
- Easy clean vinyl
- Anti-bacterial, anti-static, waterproof cover

- #4014 WP-N Cushions 16" x 18" x 2"
- #4016 WP-N Cushions 16" x 18" x 3"
- #4029 WP-N Cushions 16" x 18" x 4"
- #4015 WP-N Cushions 16" x 16" x 3"
- #4029 WP-NM with Masonite Insert 16" x 18" x 4"

### Seat Cushion - Invalid Ring

- Comfort with pressure cut-out in center
- Washable Brushed Navy Cover
- Size 16" x 18" x 3"



#3179 Seat Cushion - Invalid Ring

**MADE IN USA**



**HCPCS 2601**



### Leather Seat Cushion with Lumbar Support

- Ideal for wheelchairs, home or auto
- Soft pliable black leather
- Features include an lumbar support
- Fits any seat size

#4008 Leather Seat Cushion 38" x 18"

#4008



### Deluxe Wheelchair Cushion

- Designed to promote proper positioning and skin protection
- Molded foam core - unique contour design
- Fire retardant cover and water resistant. Removable and washable
- Bottom side has slip free surface to remain in place.
- Size: 16" x 18" x 2"

#3800 Deluxe Wheelchair Cushion

### Wheelchair Plush Cushion

- Contours to arms, back and seat for total comfort
- Overstuffed soft fiberfill
- Polycotton plaid cover
- Seat size 16" x 16"
- Back 16" x 22"
- Arm 16" x 18"
- Available in Plaid or Fancy Black



#4115 Wheelchair Plush Cushion

#4115 **MADE IN USA**



#4000

**MADE IN USA**

### Fold & Carry Cushion

- Soft synthetic fleece seat with velour cover
- An ideal go anywhere cushion
- Seating area 13" x 15"
- Folds to 6 1/2" x 15" with hook and loop closure
- Convenient carry handles

#4000 Fold & Carry Cushion



**UNIQUE POCKET DESIGN**

Space Saver Bed Wedges With Savings on Freight Charges

## The Space Saver Bed Wedge with Pocket

- Perfect for head, foot or leg elevation
- White or Blue zippered washable cover with sewn pocket. Holds TV remote, T.V. guides, magazines, and more
- Foam meets CAL 117 requirements

Shipped at its true weight  
No oversized charges

**MADE IN USA**

- #3067SS—Bed Wedge (7" x 20" x 20") Packed two per carton
- #3068SS—Bed Wedge (10" x 20" x 20") Packed two per carton
- #3069SS—Bed Wedge (12" x 20" x 20") Packed two per carton

Available in White or Blue Covers



## 3-in-1 Bed Wedge with Pocket

- #3067 Bed wedge 7" x 24" x 24" (2 Per Ctn.)
- #3068 Bed wedge 10" x 24" x 24" (2 Per Ctn.)
- #3069 Bed wedge 12" x 24" x 24" (2 Per Ctn.)

#3068FB Fleece Top, Blue 10" x 24" x 24" **NEW!** (2 Per Ctn.)



Available in White or Blue Covers

- Perfect for head, foot or leg elevation
- White or Blue zippered washable cover with sewn pocket holds TV remote, T.V. guides, magazines and more
- Foam meets CAL. 117 requirements
- 2 per case
- Easy carry zippered bag



#3066

## Convoluted Foam Bed Wedge

#3066 Convoluted Foam Bed Wedge  
10" x 24" x 24" (2 Per Ctn.)

(Replacement covers available, add letter C - denotes cover only)



#3168

## Inflatable Bed Wedge

- Heavy gauge white vinyl
- Washable blue dacron/cotton cover
- Size 27" x 27" x 8"

#3168 Inflatable Bed Wedge  
#3168C Cover Only  
#3168K Bed Wedge and Cover

Helps:  
**Acid Reflux, Sleep Apnea, Snoring Problems, Heartburn, Sinus Drainage**

Perfect For Head, Foot or Leg Elevation



#3169

## The Comfort Wedge

- Graduated elevation to 5" height
- Fire Retardant Polyurethane Foam
- Removable Quilted Poly/Cotton Cover
- Machine Washable - White Cover
- 32" L x 26" W x 5" H

#3169 Comfort Wedge

Helps Relieve:  
• Acid Reflux  
• Snoring  
• Sleep Apnea  
• Indigestion



#3072S

### Crescent Neck Pillow

- Polyester filled for comfort and support
- Contoured to ease neck and back strain
- Excellent for traveling, home or office
- Hook and loop closure keeps in place
- Removable cover - navy, satin or fleece



#3072F



#3073

### Knee Comfort Pillow

- Helps to reduce hip strain while sleeping
- Greater sleeping comfort
- Hook and loop closure keeps pillow in place
- Washable White cover

#3073 Knee Comfort Pillow 7" x 4" x 5"

### Deluxe Knee Pillow

Restores natural body alignment

- Molded contour design helps reduce stress on hips, knees and ankles
- Helps to increase circulation in legs and feet
- Removable, washable polyester cotton cover

#3063 Deluxe Knee Pillow 10" x 8" x 5 1/2"



#3072 Crescent Neck Pillow 2" x 12"

#3072F Crescent Fleece Neck Pillow with Fleece Cover (2" x 12")

#3072S Crescent Neck Pillow with Satin Cover



### Memory Foam Neck Cushion

- Ideal for travel and relaxation
- Soft plush terry cover, navy
- Removable and washable

#3172 Memory Foam Neck Cushion (3" H)



#3063



### Easy Knee and Arm Comfort Pillow Rest

- Helps keep body in alignment
- Designed to ease pain in hips, legs, knees and back
- Easy to use hook and loop straps for perfect positioning
- Fiber fill batting with dacron/cotton cover

#3173 Easy Knee and Arm Comfort Pillow Rest



### Inflatable Knee Pillow

- Helps take pressure off lower back, hips and knees
- Adjusts easily for firmness
- Soft flocked surface stays in place
- Folds flat with carry case - for travel or home

#3031 Inflatable Knee Pillow



#3070

### Cervical Comfort Pillow

- Provides neck support to relieve pressure and tension
- Use on your side, back or stomach
- Gray, washable, removable cover
- Firm support foam
- Measures 16" x 14"

#3070 Cervical Comfort Pillow



### Inflatable Neck Cushion

- Provides neck support and comfort
- Perfect for traveling with handy carry pouch

#3049 Inflatable Neck Cushion



#3112

**Frame Mesh Lumbar Supports**

- Open weave mesh stays cool while providing adjustable support
- Cushions and supports the spine. Helps to reduce lower back fatigue
- Attaches easily, light weight and portable
- Available in Standard or Adjustable frame models (black)

#3112 Adjustable Frame Mesh Lumbar Support

3/8" x 17" x 21"

#3113 Standard Frame Mesh Lumbar Support

3/8" x 15" x 15 1/2"

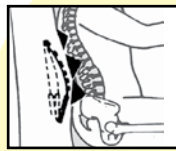

with

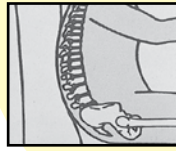

without



#3113

**Support Plus  
161 Massage Tips  
Stimulate Pressure  
Points in Back**



#3061

**Memory Foam Pillow**

- Heat sensitive foam, contours
- One size fits all – 4" width

#3061 Memory Foam Pillow

**NEW!**

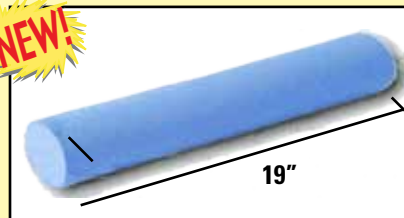

19"

MADE IN USA

#3177

**Firm Cervical Rolls**

- Ideal for cervical or sacral use
- Removable washable cover
- 19" Length available in 3 1/2", 5" and 7" width

#3177 3 1/2"

#3177 5"

#3177 7"



#3076

MADE IN USA

#3077

**Lumbar Back Support Roll**

- Seat comfort and back support
- Attaches and stays in place with elastic strap
- Washable navy poly/cotton cover

#3077 Standard Support Roll

10 3/4" x 4 3/4"

#3076 Half Roll Support

10 3/4" x 2 3/8"

#3175-4 Extra Firm Lumbar Roll

**NEW!**

12" x 4"

#3175-5 Extra Firm Lumbar Roll

**NEW!**

12" x 5"

#3176-Extra Firm Half Lumbar Roll

**NEW!**

12" x 6" x 4"



Tennis Ball  
Inside

#3171 Sciatica Cushion

MADE IN USA

**Sciatica Cushion**

**NEW!**

- Unique design encases tennis ball with polyester batting
- Attractive brush navy cotton/polyester, soft cover
- Helps relax the Piriformis muscle and relieve stress on sciatic nerve
- Most effective when used in sitting position - placing at the area of pain
- Size - 6" x 10"



#3071

MADE IN USA

**Elevating Leg Rest**

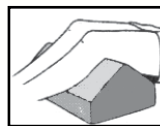

- Unique design for knee elevation
- For treatment of phlebitis, varicose veins or tired legs
- Helps to flatten lower spine to reduce lower back pain
- Washable blue denim cover

HCPCS  
E0190

#3071 Elevating Leg Rest 17" x 10" x 7"

#3071XL Elevating Leg Rest 28" x 10" x 7"

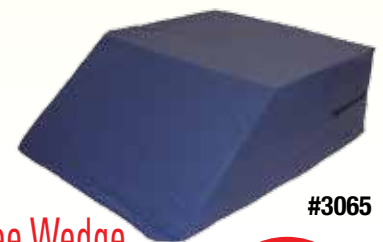

#3065

**Ortho Knee Wedge**

HCPCS  
E0190

MADE IN USA

- Navy washable zippered cover
- Elevates legs comfortably
- Promotes circulation to legs
- Helps to flatten lower spine to reduce lower back discomfort

#3065-8 Ortho Knee Wedge 8" x 20" x 25"

#3065-10 Ortho Knee Wedge 10" x 20" x 30-1/2"





HCPCS  
E0190

#3060

### Convuluted Comfort Pillow

- Perfect support for head and neck
- Special convuluted design promotes better air circulation and relieves pressure
- Keeps user cool and comfortable
- Removable white poly/cotton cover
- Size, 22-1/2" x 16"
- Foam meets CAL 117 requirements
- Ideal for proper alignment

#3060 Convuluted Comfort Pillow



#3062

HCPCS  
E0190

### Butterfly Orthopedic Pillow

- Therapeutic support for neck and back
- Maintains proper neck and spine alignment
- Polyester fiber filled
- Removable Blue satin cover
- Can be used to elevate knees and calves
- Size 17" x 22"

#3062 Butterfly Orthopedic Pillow 17" x 20"



HCPCS  
E0190

#3064

### Comfort Plus Pillow

- Special design with polyester filling
- Good for sleeping on back or side
- Helps maintain spinal alignment
- Comfortable white poly/cotton self cover
- Center recess cradles head – bottom keeps neck in proper alignment

#3064 Comfort Plus Pillow 19" x 23"

Replacement covers available on all of our Orthopedic Pillows  
Call customer service for more information



#3174

HCPCS  
E0190

#3074

### Cervical Neck Pillow

- Round cervical pillow
- Polyester filled
- Perfect for neck support
- Non-removable poly/cotton cover

#3074 Cervical Neck Pillow 7" x 17"  
#3075 White Zippered Cover 7" x 17"  
#3075S Satin Zippered Cover 7" x 17"  
#3174 Convuluted Neck Pillow 7" x 17"

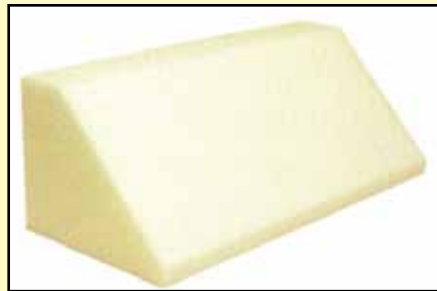

### Body Positioner with Navy Cover

- Helps to align and maintain body position
- Ideal for use as wedge or for knee elevation
- Polystyrene foam (24" x 10 1/2" x 8 1/2")
- Meets Cal. 117 specifications

#3019 Body Positioner & Cover



### Face Down Wedge Pillow

- Unique design for those who must lay face down for comfort and medical requirements
- Comfort contour enables women to lay flat - reverse side flat for men.
- The face is cradled with spine in correct position
- Polyurethane foam with washable white cover
- 29" x 14" x 6" -1-1/2"

#3059 Face Down Wedge Pillow



### Comfort Curve Pillows

- Designed for cervical and thoracic support
- Helps to ease neck and upper back strain
- Easy to position for maximum comfort
- Makes an ideal total body pillow

#3053T Comfort Curve Pillow Travel size (14" x 14")  
#3053S Comfort Curve Pillow Standard size (17" x 22")

## Saf-T-Seal® Cast & Bandage Protector

- Unique patented ring eliminates need for strapping or hook and loop closure
- Latex free diaphragm, stretches easily over cast to form watertight seal
- Durable polyvinyl protector prevents water penetration.

**LATEX FREE!**



### Hand, Arm, Foot and Leg

#### Adult

- #6010 Foot/Ankle (10")
- #6011 Hand (11")
- #6012 Short Arm (22")
- #6013 Long Arm (29")
- #6014 Short Leg (33")
- #6015 Long Leg (42")

#### Pediatric

- #6020 Medium Arm (18")
- #6021 Large Arm (22")
- #6022 Medium Leg (18")
- #6023 Large Leg (23")



Extra Wide Opening  
#6012W Short Arm (22")  
#6014W Short Leg (23")

**Saf-T-Seal®** **ROSE**  
CASTING SUPPLY

Hand, Arm, Foot and Leg Cast and Bandage Protector

---

**Bathe or Shower with Confidence and Comfort**



- Unique ring eliminates need for velcro bags with strapping or hook and loop closure
- Latex free diaphragm, stretches easily over cast to form watertight seal
- Durable polyvinyl protector prevents water penetration.

NOTE: Use caution when in wet, slippery conditions. Check for sharp surfaces on plaster casts. Always grasp plastic ring to remove.  
Made in Taiwan

**Attractively Boxed**



**HCPCS L3260**

#6004

### Deluxe Post-op Shoe

- Hook and loop straps
- Padded heel collar for comfort
- Blue nylon mesh
- Skid resistant bottom

#6004 Deluxe Post-op Shoe



#6000

### Rocker Bottom Cast Shoe

- Aids in patient mobility
- Open toe and heel for comfort
- Hook and loop closure for better fit
- Non-slip design
- Attractive blue duck fabric

#6000 Rocker Bottom Cast Shoe



#6002

### Post-op with Hook & Loop Closure

- For post surgical fracture bracing
- Skid resistant sole
- Heavy duty vinyl – bone color

#6002 Post-op with Hook & Loop Closure

SIZE CHART	POST-OP SHOE SOLE DIMENSIONS		
Size	A	B	C
Women's Small	9 7/8"	3 5/16"	2 5/8"
Women's Medium	10"	3 1/2"	2 5/8"
Women's Large	10 1/8"	3 5/8"	2 3/4"
Men's Small	11"	3 7/8"	3"
Men's Medium	11 1/2"	4"	3 1/8"
Men's Large	12"	4 1/8"	3 1/8"

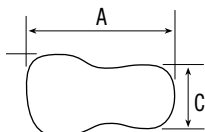



#6034

### Cast and Bandage Protector

- Heavy duty PVC heat sealed seams
- Adjustable latex straps for closure
- Easy to use without assistance

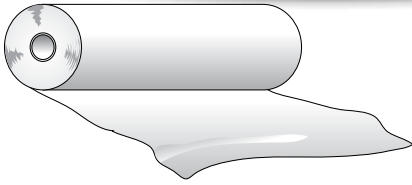
- #6030 **Foot/Ankle - Adult (one size fits most) 10" x 17-1/4"**
- #6031 **Half Arm Adult/Full Arm Child 8" x 29"**
- #6032 **Full Arm Adult 10" x 29"**
- #6034 **Half Leg Adult/Full Leg Child 13" x 41"**
- #6035/6036 **Medium/Large Leg - Full Leg Adult 15" x 41"**



## Rubber/Flannel Waterproof Sheeting

- Comfortable cotton flannel bonded to rubber
- Autoclavable and waterproof
- Provides longlasting comfort and protection

- #5100 Rubber Flannel Sheeting - 36" x 36"
- #5102 Rubber Flannel Sheeting - 36" x 54"
- #5104 Rubber Flannel Sheeting - 36" x 72"
- #5106 Rubber Flannel Sheeting - 36" - 12 yd. roll

## Water Proof Draw Sheet



- Total comfort and absorbency
  - Super absorbent pad (34" x 36") with tuck-tails to hold pad in place
  - Fits full size beds with 20" tails on each side
  - Machine wash and dry
  - Three layer pad with polyester soaker and water proof bottom
- #5003 Water Proof Draw Sheet**

## Contour Fitted Sheets For Hospital Beds

- Designed specifically for the hospital bed
- Provides greater comfort and ease of patient handling
- Aids in prevention of bed sores
- Completely washable. Measures 36" x 80"
- White, 50% cotton, 50% polyester

- #5020 Contour Fitted Sheet, white, 36" x 80"
- #5021 Contour Fitted Sheet dozen per pack



#5020

## Hospital Bedding Sheet Sets

- Fitted sheet, top sheet and pillow protector
- 50% cotton/50% polyester
- 132 thread count
- Machine washable - white
- Size: 36" x 80" x 6"

#5037



## Ultra-Dry Fitted Waterproof Mattress Pads



### 100% Waterproof Protection

- Ultra soft fleece top fabric with waterproof vinyl backing
- 15" elastic all around band - easy to put on and not shift or slip off.
- Plush inner layer of Fiber Fill
- Easy care machine wash and dry

- #5071 Twin Size (36" x 75")
- #5072 Full Size (53" x 75")

- #5073 Queen Size (60" x 80")
- #5074 King Size (78" x 80")



#5000

## Protective Chair Bed Pad

- Quilted plaid seat pad
- Top layer soft brushed polyester
- Unique moisture barrier in center for improved absorption
- Bottom layer totally waterproof
- Completely washable

- #5000 Protective Pad 18" x 24" Plaid
- #5002 Protective Pad 34" x 36" Plaid



#5001

## Comfort Dry Mattress Pad

- Highly absorbent plush polyester on each side
- Center waterproof vinyl barrier for total protection
- Polyester laminated to vinyl pad
- Stays quiet and comfortable
- Pad corners stitched for extra durability
- Machine washable - White

#5001 Comfort & Dry Mattress Pad 24" x 36"



#5010

## Deluxe Quilted Underpad

- Comfort and protection
- Flannel quilted top, highly absorbent soaker barrier in center
- Bottom layer totally waterproof
- Completely washable

- #5010 Quilted Underpad 30" x 36"
- #5010XL Quilted Underpad 36" x 80" with straps



## Contoured/Zippered Mattress Protectors 36" x 80" For Hospital Beds

- Heavy duty white PVC
- Reduces odor and improves sanitation
- Extends life of the mattress
- Size 36" x 80"
- Waterproof and fire retardant

## Mattress Covers for Home Beds

- Waterproof heavy duty vinyl
- Taffeta finish, fire retardant
- Electronically sealed seams
- Anti-microbial treated
- Wipes clean with damp cloth



- #5027 Twin Contour 39" x 75"
- #5028 Twin Zippered 39" x 75"
- #5029 Full Contour 54" x 75"
- #5030 Full Zippered 54" x 75"
- #5031 Queen Contour 60" x 80"
- #5032 Queen Zippered 60" x 80"
- #5033 King Contour 78" x 80"
- #5034 King Zippered 78" x 80"

- #5022 Contour Protector 1 Unit
- #5023 Zippered Protector 1 Unit
- #5024 Contour dozen per pack
- #5026 Zippered dozen per pack

## Pillow Protectors

- Waterproof and hypo-allergenic
- Plasticized vinyl
- Rust resistant zipper

- #5035 Vinyl Pillow Protector (21" x 27")



## Knee & Elbow Warmers

- 100% acrylic stretch material
- Machine washable
- Ivory color
- One size fits all

- #3001 Knee & Elbow Warmers (Pr.)



## Angora Thermal Products "The Ultimate in Warmth and Comfort"

- Unique fabric blend allows the skin to breathe without becoming damp and is soft against the skin
- Completely washable
- Contains 40% angora, 30% wool, 30% polyamide,
- Measure circumference above the knee (3015):  
Small/Medium (12"-18-1/2")  
Large/Xtra Large (19"-26")

- #3014 Lower Back Warmer - S, M, L, XL

- #3015 Knee Warmer Wool/Angora Blend (Pr) - S/M, L/XL



#3014



#3015

## Zippered Mattress Covers

Protects against bed bugs, dust mites, and allergens



- Waterproof and fire retardant
- Antimicrobial treated to inhibit growth of mold, mildew and odor causing bacteria
- High density polypropylene
- Rust proof polyester zipper

- #5005 Standard zippered pillow case

- #5007 Hospital bed (36" x 80")

- #5008 Twin zippered (39" x 75")

- #5009 Full zippered (54" x 75")

## Cotton Bed-In-A-Bag

For Home Hospital Beds

Contains one (1) each:

- Jersey knit cotton fitted sheet
- Jersey knit cotton top sheet
- Jersey knit cotton pillow case
- 100% Cotton thermal blanket

- #5036 Cotton Bed-In-A-Bag





**Lady Rose Lace Absorbent Panty with built-in liner**

**HCPCS T4539**

- Reusable, washable premium lace panty
- Stretchy elastic waistband
- Attractive lace design
- Available in sizes Small, Medium, Large, XL, XXL

**Built-in Pad Provides Complete Protection:**

- Fast-absorbing top layer quickly wicks moisture away from body
- Soaker core absorbs & traps fluid
- Waterproof barrier protects against leakage

**#5060 Lady Rose Lace Absorbent Panty**

**Sizes for #5060 and #5062**

Women's	Small	Med.	Large	XL	XXL
Fits Hip Size	35-38	39-40	41-42	43-45	46-49



**#5065**

**Waterproof Plasticized Pull-on Incontinent Pant**

- Machine washable - plasticized polyester
- Waist and leg bands are elasticized for comfort and protection
- Can be used by men, women and children
- Perfect for use with pads, diapers and other absorbent materials

**#5065 Waterproof Plasticized Incontinent Pant**

**XS 14"-20"  
S 22"-28"**

**M 30"-36"  
LG 38"-44"  
XL 46"-52"**



**#5062**

**Absorbent Lady Rose Cotton Panty with built-in liner**

- Reusable, washable premium cotton panty
- Stretchy elastic waistband
- Attractive 100% cotton "Diamond Weave" fabric
- Available in sizes Small, Medium, Large, XL, XXL

**Built-in Pad Provides Complete Protection:**

- Fast-absorbing top layer quickly wicks moisture away from body
- Soaker core absorbs & traps fluid
- Waterproof barrier protects against leakage

**#5062 Absorbent Lady Rose Cotton Panty**



**#5004**

**Economy Waterproof Pads**

- Soft and absorbent
- Breathable, comfortable and quiet
- Prevents leakage and eliminates staining
- Polyester bonded to vinyl
- Completely washable

**#5004 Waterproof Pad 36" x 36"**

**#5006 Waterproof Pad 36" x 72"**



Inner cotton lining wicks moisture away from sensitive skin

**Mens Incontinence Brief**

Comfort - Dignity - Durability

- Washable & Reusable
- Vertical fly & waistband stripe
- Thin highly absorbent pad enclosed in soft cotton-blend panel - protects front and midway up the back
- Pad keeps moisture away from skin
- Sm. (30"-32"), Med. (34"-36"), Lg. (38"-40") XL (42"-44"), 2X (46"-48"), 3X (50"-52")

**#5070 Mens Incontinence Brief**



**Waterproof Vinyl Pants**

- Pull-on style, great protection over incontinent briefs or liners
- Soft, quiet vinyl, elastic at waist and legs
- Completely washable - machine wash & dry
- Latex Free
- Pack of 3

**#5075 Waterproof Vinyl Pants**

**M - L - XL - XXL**

**Deluxe Disposable Mattress Pads**

- Dry to the touch
- Poly backing to prevent leaks
- Protects bedding and chairs
- Hyper allergenic - Latex-free
- Linen fresh scent for odor control

**#5055 Deluxe Disposable Mattress Pads**

**21"x23", 100 Pads Per Case, (50 per poly bag)**



**HOMECARE PACK**

# Fashionable and Comfortable Gowns

## Convalescent Comfort Gowns

- One size fits all
- Easy fit-two tape ties or hook and loop
- Machine washable-polyester/cotton
- Available in attractive retail pack or bulk pack by the dozen

- #5040 Blue Retail Pack
- #5041 Blue Pack (12 Per Poly Bag)
- #5042 Yellow Retail Pack
- #5043 Yellow Pack (12 Per Poly Bag)
- #5044 Blue Print Retail Pack
- #5045 Blue Print Pack (12 Per Poly Bag)
- #5046 Mint Green Flannel Retail Pack
- #5047 Mint Green Flannel Pack (12 Per Poly Bag)
- #5048 White With Blue Print Retail Pack
- #5049 White With Blue Print (12 Per Poly Bag)
- #5050 Blue w/velcro closure Retail Pack
- #5051 Blue (5040 w/velcro closure) (12 Per Poly Bag)



#5042

#5040

#5048

#5044

NEW COLOR

#5046 & #5047  
(Flannel)

## IV Patient Gowns

NEW!

- Easy on/off snaps on shoulder
- Machine washable-polyester/cotton
- One size fits all
- Attractive print pattern

#5052 IV Patient Gown



NEW!



## Men's Plaid Nightshirt

NEW!

- Comfortable and functional
- One size fits all
- Hook & loop back closure
- Dacron/Cotton, completely washable

#5056 Men's Plaid Nightshirt

## Dignity Convalescent Gown

- Unique design attaches at the shoulder by snaps. Gown goes on over the head, poncho style.
- Ties on back panel come around and tie in front - covering the back.
- Completely washable - 55% cotton, 45% polyester.
- One size fits all.

#5053 Dignity Convalescent Gown

## Non-Slip Wheelchair Blanket

- Lightweight, soft, cozy, comfy feel
- Two hook and loop tabs keep it securely attached
- Two hand warmer pockets & one middle pocket
- Tapers at bottom to avoid getting caught in wheels
- 95% polyester, 3% pp, 2% nylon
- 41" x 30" x 19.69" (tapered)

#5054 Wheelchair Blanket (Burgundy)



NEW!

**ALL NEW!**



#4031-4

### 4" Foot Elevator

- Ideal for the prevention and treatment of decubitus ulcers
- Hook and loop closure
- Washable flannel cover
- One size fits all

### #4031-4 4" Foot Elevator



RELIEF FOR  
PLANTAR FASCIITIS,  
HEEL SPURS &  
ACHILLES TENDONITIS

HCPCS  
L4396

#7114

### Passive Night Splint

- Splint adjust easily and holds foot and toes in a position - pair of gel heel cushions included
- Stretches plantar fascia and the achilles tendon
- Soft padded velour is washable
- Fits right or left foot men's 6-12 women's 4-13

### #7114 Passive Night Splint-One Size Fits All

PLEASE SPECIFY  
STANDARD OR LARGE



#7116

### Toe Caps

- Long lasting, machine washable silicone-based hydrogel toecaps
  - Effective for use on H.D. and H.M. lesions
  - Ideal treatment for corns on the toe tip or hammer toe
  - Available in standard and large (big toe)
- #7116 Toe Caps (2 per package)



Patented fasciitis bar provides midfoot support

### Heel Saver

Indications-Plantar Fasciitis, Heel Spurs and Arch Pain

- Made from durable Kraton material for long-time use
- Washable
- Applies accurate acupressure as weight shifts
- Does not interfere with the fit of the shoe
- Use with any type of shoe with a backing
- Stays in place

#7124Std Heel Saver, Standard (Pr.) (Women's Size: 7-10, Men's Size: 5-8)

#7124Lg Heel Saver, Large (Pr.) (Women's Size: 10 & Up, Men's Size: 9-12)



Provides natural structural reinforcement to prevent partial collapse of the midfoot



Redistributes the heel's natural fat pad, actually increasing its density



Applies continuous localized, acupressure directly beneath the heel pain hot-spot

ADJUSTABLE  
HOOK & LOOP  
CLOSURES STRAPS



#7112



### Arch Brace for Plantar Fasciitis

- Immediate pain relief
- Relieves inflammation and heel pain
- Two adjustable straps attach easily
- Can be worn against skin or over hosiery

#7112-A Arch Brace (Men's 7-8 1/2, Women's 6-10 1/2)

#7112-B Arch Brace (Men's 9-13)



#7115

### Comfort Gel Heel Cushions

- Soft, breathable **fabric** cover on one side, shock-absorbing **gel** on the other side
- Tapered edge for better fit
- Available Men's (7-13) shoe size and women's (5-11) shoe size

#7115M Comfort Gel Heel Cushions (Men's Pr.)

#7115W Comfort Gel Heel Cushions (Women's Pr.)

**RELIEVE All Forms of Heel Pain**  
**REVERSE Progressing Conditions**  
**PREVENT Future Recurrences**  
**Medically Proven 99.7% Success Rate**



3 ROLLS PER  
PACKAGE

#3054

### Finger and Toe Protective Bandage

- Soft breathable foam-lined with seamless tubular cotton fabric
- Relieves irritation due to friction bruises and pressure
- 3 rolls package – 36" per roll

Sizes: #3054 5/8" O.D.  
#3055 3/4" O.D.  
#3056 1" O.D.  
#3057 1- 36" one each of 5/8", 3/4" and 1"



**NEW!**

### Easy Cut Toe Nail Nippers

- Surgical steel blades
  - Stay sharp
  - No-slip soft handle
  - 5-1/2" long spring design - easy to use
- #7160 Easy Cut Toe Nail Nippers

**NEW!**



### Bunion Gel Pad

- Orthotic sleeve with sewn-in gel pad supports cushions and protects painful bunions
- One size fits most - right or left
- Nylon, spandex, silicone

#7144 Bunion Gel Pad

### Gel Corn Pads

- Made with a technologically advanced gel
- Clinically proven to help provide immediate all-day relief
- Will not snag hosiery
- Fits most types of shoes
- Washable and reusable



#7118N Narrow - (10 per pkg)  
 #7118M Medium - (10 per pkg) #7118N  
 #7118W Wide - (10 per pkg)



#7119

### Calcaneal Heel Cups

- Ideal for high heels and Plantar heel spur
- Eliminates gapping and slipping of shoes
- Unbreakable plastic

#7119 Junior - (6 pr/pkg)  
 # 7119 Standard - (6 pr/pkg)



#8113

#8114

### PneuGel® Ankle Support or Economy Ankle Support

HCPCS  
L4350

- #8114 Allows patient to inflate or deflate the bladder to provide maximum comfort, support and protection
- #8114 lower chambers contain gel, allowing the support to be used in cold therapy applications
- #8113 utilizes pre-sealed air filled bladders and provides excellent support and protection
- #8114 bladders are removable and can be placed in the freezer allowing them to be used as cold therapy devices

#8113 Economy Strirup Ankle Support (one size fits all )  
 #8114 PneuGel® Ankle Support (one size fits all )  
 (Pump Included)

**NEW!**

### Bunion Regulator



- Night time appliance
- Molded splint cradles and repositions big toe
- Stretches tendons and muscles
- Washable - one size fits all • Indicate right or left foot

#7140R Bunion Regulator  
 #7140L Bunion Regulator

#7140R - Bunion Regulator - Right



**MOLDED TO ORTHOPEDIC FORM**

### Crest Buttress Pads

- Pad catches minor problems early and helps claw and hammer toes maintain a more normal position
- Relieves pressure and friction which causes corns and soreness
- Lightweight, washable foam pad

#7120SR Small Right  
 #7120SL Small Left  
 #7121MR Medium Right  
 #7121ML Medium Left  
 #7121LR Large Right  
 #7121LL Large Left



### Plantar Fasciitis Night Splint

- Helps relieve heel pain and Achilles Tendonitis as well
- Worn at night to stretch Plantar Fascia and Achilles
- Stretch helps reduce inflammation, pain and tenderness
- Latex free, easy to use velcro straps

#7110 Night Splint / One Size Fits All

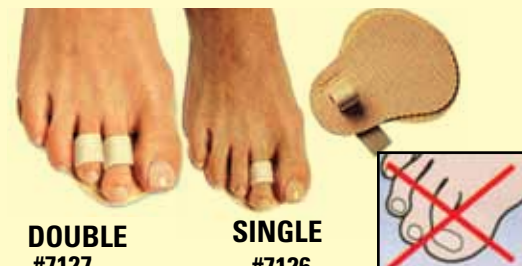

**DOUBLE**  
#7127

**SINGLE**  
#7126

### Toe Regulators

- Ideal for surgical procedures for hammer toes or metatarsals
- Totally adjustable single or double loop
- Provides immediate comfort
- Completely washable

#7126 Single Loop  
 #7126DZ Single Loop Dz. Pack  
 #7127 Double Loop  
 #7127DZ Double Loop - Dz. Pack  
 #7128R Triple Loop, Right  
 #7128L Triple Loop, Left

**NEW!**





## Diabetic Cushioned Socks

- Cushioned terry soles
- Non-binding tops
- Non-irritating flat toe seams
- Cotton/poly/nylon/lycra
- Made in USA

#7152W - Women's sizes 9-11  
#7152M - Men's sizes 10-13

## New... Skin Cream created specifically to meet the exacting demands of diabetic skin care by a diabetic physician

- Helps reduce the risk of foot complications due to diabetes
- Contains antioxidants and vitamins A, D, E, Provitamin B5 for healthy skin and nerves
- Moisturizes and softens feet and reduces painful cracking and dryness

#7170 Diabetic Foot Cream  
(5 oz. tube)

#7170DP (Display plus 6 units)

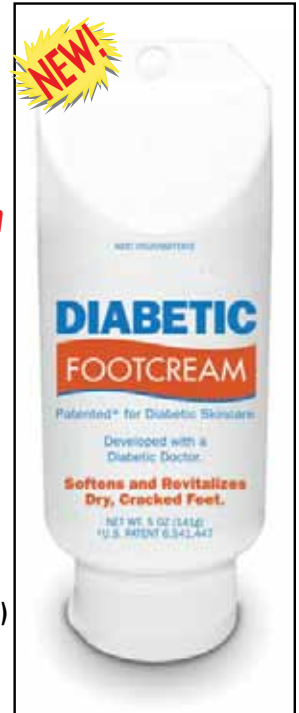

## Diabetic Slipper Socks with Gripper Soles

- Comfort, Protection and Non-Slip Design
- Use as Slipper or Footwear
- Helps Reduce Pressure on Sensitive Legs

#7134 Ladies Size 9-11  
#7135 Men's Size 10-13  
#7135XL Size 14-17 (Black or White only)

Colors - White, Tan, Black  
(Made in USA)

## Diabetic Sock with Gel Heel

Maximum Comfort:

- Pressure Free Socks
- Improves Circulation
- Cool Breathable, 80% Cotton, 20% Nylon, Silicone

Unique Gel Heel For:

- Support
- Cushioning
- Comfort
- Keeps Heels from Drying Out
- Helps Prevent Friction & Callus Formation



#7133W (Ladies Size 6-9)  
#7133M (Men's Size 9-12)



## Multi-Purpose Diabetic Socks

- Ideal for Diabetic, Poor Circulation or Sensitive Feet
- Extra Wide, Non-Binding Top
- Stays in Place Plus Support for Calf Muscles
- Unique Blend 85% Cotton, 13% Poly, 2% Elastic
- Soft, Breathable and Washable
- Colors: White or Black
- 2 pair per package

**MADE IN USA**

#7136 Black - Small (Size 6-8), Medium (Size 9-11), Large (Size 10-13), X Large (Size 14-17)  
#7137 White - Small (Size 6-8), Medium (Size 9-11), Large (Size 10-13), X Large (Size 14-17)

## Arthritic/Diabetic Gel Socks

- Soft and lightweight sock combined with proprietary gel insole that cushions, supports, and helps absorb shock to the entire plantar (bottom) surface of the foot, heels, ankles, knees, and back.
- Product is designed to conform to the anatomical shape of the user's foot.
- Will not flatten under repeated pressure.
- Helps reduce friction, abrasion, shear forces, and callus formation
- Serves as a soft tissue supplement to fat pad atrophy

#7150S - #7150M - #7150L

**MADE IN USA**

### SPECIFY SIZE

Small - Shoe size 6 or under - #7150S  
Med. - Shoe size 9 or under - #7150M  
Lg. - Shoe size 9 or over - #7150L





## Full Face Mask

#9102 Full Face Mask

#9103 Full Face Replacement Seals, Small-Medium-Large

**Lightweight Contoured Silicone Design:** This Full Face Mask is made of soft contoured medical liquid silicone, making it extremely durable, flexible, comfortable and easy to clean. Best of all, it is designed to fit comfortably and provide an excellent seal without the need for a forehead support.

**360° Dual Swivel Elbow Port:** Allows for free patient movement

**Ergonomic, Flexible Design:** Contours naturally to the face and designed with a ribbed support for comfort, fit, and seal.

**Headgear with Quick Release Clips:** Mask can be easily removed for patient convenience.

**Air Vent Holes and One Way Valve Design:** The exhale port is designed to minimize CO2 retention.

**Available in 3 Sizes:** Small, Medium, Large.



## Nasal Mask

Two Sizes to Cover Different Ranges in Patient Size: Medium, Large.

#9104 Nasal Mask

**Single-Piece Silicone Design:** The lightweight single-piece mask is made of soft medical liquid silicone making it extremely durable, flexible and comfortable as well as very easy to clean.

**360° Dual Swivel Elbow Port:** Allows for free movement and easy connection to the hose.

**Ergonomic Design:** Automatically-contoured design with ribbed support enhances seal, comfort and fit.

**Headgear with Quick Release Clips:** Mask can be easily removed without resetting the headgear for convenience.

**Comfortable and Adjustable Forehead Support:** This single-piece silicone mask is soft and flexible so that it can be adjusted in any position which provides the best stability and comfort.



## Sleep Apnea CPAP Pillow

Quality polyester filling

- Unique patented design helps hose stay in position preventing air from leaking out.
- Promotes natural breathing rhythm
- Anti-microbial and hypo-allergenic

#9112 Sleep Apnea CPAP Pillow

#9112C Cover for Sleep Apnea CPAP Pillow



## Sleep-Ease Apnea Memory Pillow

- Total Comfort and Compliance for C-Pap and Bi-Pap Users.
- Unique Ergonomic Design Allows Shoulders, Neck and Head Support
- Contact Free Mask Use Sleeping on Back or Side.
- Washable White Poly/Cotton Cover
- 21" L x 15-1/2" W x 4" H

#9106 Memory Pillow & Cover

#9107 Replacement Cover



## C-PAP Chin Strap

- Cradles jaw to help keep your jaw closed
- Stretch neoprene strap
- Adjustable and lined for comfort
- Works with all C-PAP Masks
- Max circumference 32-1/2"

#9115 C-PAP Chin Strap



## CPAP Hose Holder

Sleep easy-without discomfort

- Adjustable sliding arm
- Slides between mattress & box spring
- Sturdy metal construction
- No assembly required
- Compactly folds for storage & portability
- Includes free storage pouch
- 34.5" tall

#9108 CPAP Hose Holder



## RH4200 Mini Oxygen Regulator

- Compact and lightweight, less than 10 oz.
- Flow: 0-8 L/min.

#RH4200 Mini Oxygen Regulator

## RH4300 Mini Oxygen Regulator

- Compact Design
- Lightweight, less than 10 oz
- Flow 0-15 liters/min.

#RH4300 Mini Oxygen Regulator

#RH4400 Oxygen Conserver Regulator

**ProKit™ Combo**  
**Aneroid Sphygmomanometer and Aluminum Dual Head Stethoscope with Attaché Case**

**Includes:**

- Coordinating adult calibrated nylon cuff with 2-tube bladder
- Standard air release valve and inflation bulb
- Aluminum dual head stethoscope
- One spare set of eartips

Colors Available: 01-Black, 02-Navy, 03-Royal Blue, 04-Burgundy, 06 Green, 08-Magenta, 11-Purple

#02-127 ProKit™ Combo



**NEW!**

**Self-Taking Home Blood Pressure Kit**

- Aneroid gauge with large dial, easy-squeeze inflation bulb and attached professional stethoscope
- Soft cotton D-ring-cuff allows for easy application
- Adult size cuff fits arm circumference: 10"-14"
- Latex-free

**Includes**

Gauge, inflation bulb, attached stethoscope, adult arm cotton cuff, zippered attache case, detailed English/Spanish guidebook and blood pressure reading log

#01-5501 - Self-Taking Home Blood Pressure Kit



**NEW!**

**Aluminum Dual Head Stethoscope**

- Lightweight anodized aluminum chestpiece with non-chill diaphragm retaining ring and vinyl Y-tubing, latex free.
- Complete with spare diaphragm, mushroom eartips and Lifetime Limited Warranty

#05-121 Aluminum Dual Head Stethoscope



**NEW!**

Colors Available: 01-Black, 02-Navy, 03-Royal Blue, 04-Burgundy, 06 Green, 08-Magenta, 11-Purple

**Replacement Cuff Automatic Blood Pressure Arm Monitor**

- Replacement cuff for automatic blood pressure arm monitors
- Latex-free

#01-5921 - Replacement Cuff (Adult-11-3/4" - 16-1/2")  
 #01-5922 - Replacement Cuff (Large Adult - 16-1/2" - 18-7/8")  
 #01-5926 - Replacement Cuff (Small Adult - 8-5/8" - 11-3/4")



**NEW!**

**Automatic Digital Blood Pressure Wrist Monitor**  
**EASY HOME MONITORING**  
**ONE-BUTTON OPERATION**  
**CLINICALLY ACCURATE READINGS**



#01-506 - Automatic Digital Blood Pressure Wrist Monitor  
 Also Available

#01-516 - Jumbo Screen Premium Blood Pressure Wrist Monitor  
 #01-526 - Talking Ultra Digital Blood Pressure Wrist Monitor

- Clinically accurate readings
- One-button blood pressure measurements
- Fully automatic inflation and deflation
- Simultaneous systolic, diastolic and pulse results
- 60-reading memory bank
- Memory recall with date/time stamp
- Average of last 3 readings
- Hypertension indicator
- Irregular heartbeat detection
- Automatic shut-off
- Latex-free cuff fits wrist size: 5-1/2" - 7-5/8"
- Canvas storage case
- Batteries; 2 AAA



**Economy Wrist Blood Pressure & Pulse Monitor**

- Slip on wrist and press button
- Stores up to 60 readings
- Plastic carrying case
- Requires 2 AAA batteries (not included)

#9100 Wrist Blood Pressure & Pulse Monitor

1 touch operation  
**NEW!**  
 Clinical Accuracy  
 • Quick  
 • Accurate  
 • Easy to Use

**Adjustable neck strap and storage case**

- Two year limited warranty

#9101 Deluxe Fingertip Pulse Oximeter

**Deluxe Fingertip Pulse Oximeter**

- Safely monitor oxygen levels and pulse rate
- One button operation
- Automatic shut-off
- Batteries included (2AAA)



**NEW!**

## Semi-Automatic Digital Blood Pressure Arm Monitor



**NEW!**

### EFFICIENT HOME MONITORING MANUAL INFLATION, AUTOMATIC DEFLATION CLINICALLY ACCURATE PERFORMANCE

- Clinically accurate readings
- Manual inflation and automatic deflation
- Easy-squeeze bulb
- Simultaneous systolic, diastolic and pulse results
- 60-reading memory bank
- Memory recall with date/time stamp
- Hypertension indicator
- Irregular heartbeat detection
- Automatic shut-off
- Latex-free adult cuff fits arm size: 11-3/4" - 16-1/2"
- AC adapter port
- Canvas storage case
- Batteries included; 4AA

#### Complete Monitoring System

Monitor, adult nylon arm cuff with inflation bulb, canvas storage case, four AA batteries, detailed English/Spanish guidebook, quick start guide, FAQ pamphlet and blood pressure charging log.

**#01-5041 - Semi-Automatic Digital Blood Pressure Arm Monitor  
Mabis Model #04-391-001**

**#01-5042 - Semi-Automatic Digital Blood Pressure Arm Monitor  
with Extra Large Cuff**



**NEW!**

## Deluxe TENS Unit

Five year warranty

**#T-2500**

- Provides relief from a variety of pain including: back pain, headaches, sports injury pain and general muscle pain
- Pulse width (60-250) and a pulse frequency (2-150) are adjustable
- Dual isolated channels (2 leads per channel)
- Device offers dual channels, fully adjustable parameters and three modes, burst (B), normal (N) and modulation (M)
- Comes complete with timer, adjustable in 30 minute, 60 minute or constant time
- Two independent output terminals
- Equipped with a 360 degree wire connector
- Comes complete with carrying case, lead wires, 9-volt battery, manual and pack of 4 self adhesive electrodes

**#T-2500 Deluxe TENS Unit**

**#TENS Accessories for T2500 and T6000**  
**#T6010 - Electrode (1.75 inch, 45 mm round)**  
**#T3600 - 360° Lead Wires**

## Automatic Digital Blood Pressure Arm Monitor



**NEW!**

### EASY HOME MONITORING ONE-BUTTON OPERATION FULLY AUTOMATIC INFLATION/DEFLATION

- Clinically accurate readings
- One-button blood pressure measurements
- Fully automatic inflation and deflation
- Simultaneous systolic, diastolic and pulse results
- 60-reading memory bank
- Memory recall with date/time stamp
- Hypertension indicator
- Irregular heartbeat detection
- Automatic shut-off
- Latex-free adult cuff fits arm size: 11-3/4" - 16-1/2"
- AC adapter port
- Canvas storage case
- Batteries included; 4AA

#### Complete Monitoring System

Monitor, adult nylon arm cuff, canvas storage case, four AA batteries, detailed English/Spanish guidebook, quick start guide, FAQ pamphlet and blood pressure charging log.

**#01-5021 - Automatic Digital Blood Pressure Arm Monitor  
Mabis Model #04-591-001**

**#01-5022 - Automatic Digital Blood Pressure Arm Monitor  
with Extra Large Cuff**



**NEW!**

## Digital TENS Unit with 5 Mode Options

**#T-6000**

- Simple to operate, portable device for pain treatment
- Five year warranty
- Pulse width (50-300) and pulse frequency (2-150) are adjustable
- Unit can set parameters accurately and easily operate with LCD display to monitor the patients' condition
- Includes a patient compliance timer that records individual session time and cumulative time
- Unit has five mode outputs - Burst (B), Normal (N), MRW, Strength Duration (SD) and Bi-Pulse.
- Comes complete with carrying case, lead wires, 9-volt battery, manual and pack of 4 self-adhesive electrodes

**#T-6000 Digital TENS Unit**

**DIGITAL THERMOMETERS - ATTRACTIVE RETAIL PACKAGING!**

**FAST AND ACCURATE READINGS**  
**DUAL SCALE - 1-SECOND, ONE TOUCH MEASUREMENTS**

60 Second  
Read-Out

**NEW!**

CLINICAL  
RIGID TIP



- Clinical accuracy to 2/10ths of a degree F
- Peak temperature tone
- Memory recall of last reading
- Fever alert for temperatures above 99.5°F
- Fahrenheit/Celsius measurements

#08-352 - 6 pack

30 Second  
Read-Out

**NEW!**

FLEXIBLE  
TIP



- Oral, rectal, or underarm use
- Waterproof for sanitary cleaning
- Automatic shut-off
- 2-piece full storage case
- Low-battery indicator
- Battery included: LR41

#08-355 - 6 pack

9 Second  
Read-Out

**NEW!**

FLEXIBLE  
TIP



- Complete monitoring system
- Thermometer, 2-piece full storage case
- 5 probe covers
- Long lasting LR41 battery
- Detailed English/Spanish instructions

#08-359 - 6 pack

Probe Covers  
Closed System Design

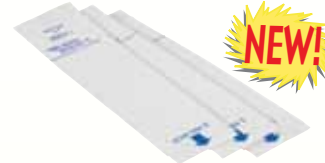

**NEW!**

- Universally sized to fit most thermometers
- Features a safe, closed-system to prevent the spread of germs
- For oral, rectal or underarm use
- Disposable and easy to use
- Hanging peg hook style box
- Full-color retail packaging
- 30 count/box

#08-328 - 6 boxes of 30

**Talking Thermometers - Includes 3 Frogs, 3 Dogs and 2 Monkeys!**

- 20-second readout
- Peak temperature tone
- Memory recall of last reading
- Fever alert plays corresponding animal sound for each thermometer, "Ribbit, Ribbit, Ribbit" for the Frog, "Ooooh Oohh, Aaaah Aaahhh" for the Monkey, and "Ruff, Ruff, Ruff" for the Dog
- Fahrenheit/Celsius measurements

- Soft flexible comfort tip
- Oral, rectal or underarm use
- Automatic shut-off
- Low battery indicator
- Meets ASTM Standard E-1112
- Latex-free, BPA-free

#08-3758D (Display plus 8 units)

**Complete Monitoring System**

Thermometer, half storage case, 5 probe covers, 2 long-lasting LR41 batteries and detailed English/Spanish instructions.

**NEW!**



**Temple Touch  
Mini Digital Thermometer**

- For infants and children
- Proven clinically accurate
- One-button operation
- Memory recall of last reading
- Fahrenheit/Celsius measurements
- Automatic shut-off
- No probe covers required
- Meets ASTM Standard E 1112
- Latex-free
- Batteries included: 2AAA

#09-330  
3 per case

6 SECOND  
READOUT



**NEW!**

**Instant Digital Ear Thermometer**

- Proven clinically accurate
- One-second tympanic readout
- Backlit, illuminated LCD display
- Peak temperature tone
- Memory recall of last 10 readings
- Fever alert for temperatures above 99.5°F
- Fahrenheit/Celsius measurements
- Automatic shut-off
- No top covers required
- 2-piece full storage case
- Low-battery indicator
- Battery included: 3 volt lithium battery CR2032
- Detailed English/Spanish instructions.

#09-340  
One per case

**NEW!**



## VH Compact™

### Tabletop Compressor Nebulizer System

**LIGHTWEIGHT, COMPACT DESIGN**  
**FAST AND EFFECTIVE MEDICATION DELIVERY**  
**EASY, ONE-BUTTON OPERATION**

- Lightweight compact design
- Piston-style compressor pump
- Treatments delivered in 8-10 minutes
- Built-in nebulizer holder
- Maximum compressor pressure: 36 psi
- Compressor air flow: 6-8 lpm
- Nebulization particle size .05-10 microns

- Unit weight: 3 lbs. 9 oz.
  - Dimensions: 7-1/2" L x 6" W x 4-1/2" H
  - Latex-free
- ( NOTE: Replacement parts available)

#### Complete Nebulizer System

Compressor, nebulizer, angled mouthpiece, 7 ft. air tubing, five air filters, removable power cord, detailed English/Spanish instruction manual and FAQ pamphlet.

#11-505 - VH Compact Tabletop Compressor Nebulizer



## VH Complete™

### Tabletop Compressor Nebulizer System

**CONVENIENT ALL-IN-ONE STORAGE DESIGN**  
**FAST AND EFFECTIVE MEDICATION DELIVERY - EASY, ONE-BUTTON OPERATION**



POWER CORD STORAGE

- Piston-style compressor pump
- Treatments delivered in 8-10 minutes
- Handy self-contained design
- Accessory storage compartment
- Built-in power cord storage area
- Built-in nebulizer holder
- Built-in carrying handle

- Maximum compressor pressure: 36 psi
- Compressor air flow: 6-8 lpm
- Nebulization particle size .05-10 microns
- Unit weight: 4 lbs. 5 oz.
- Dimensions: 11-1/2" L x 6-3/4" W x 3-3/4" H
- Latex-free

#### Complete Nebulizer System

Compressor, nebulizer, angled mouthpiece, 7 ft. air tubing, five air filters, detailed English/Spanish instruction manual and FAQ pamphlet.

#11-503 - VH Complete Tabletop Compressor Nebulizer

## VH Sonic Mist™

### Ultrasonic Nebulizer System

**RELIABLE ULTRASONIC TECHNOLOGY**  
**QUIET, QUICK TREATMENTS - PORTABLE CONVENIENCE**

- Reliable ultrasonic technology
- Most treatments delivered in less than 6 minutes
- Creates smaller, more uniform particle size than compressor-style nebulizers
- Consistent nebulization: Particle size 1-10 microns
- Virtually silent medicine administration

- Handheld, portable design weighs less than 1 lb.
- Automatic shut-off
- Operates with tap or distilled water
- Three power options: rechargeable battery pack, AC adapter and DC auto adapter

#11-520 - Ultrasonic Nebulizer System

#### Complete Nebulizer System

Nebulizer, rechargeable 12-volt NiMH battery back, 12-volt AC adapter, 12-volt DC auto adapter, child mask, adult mask, extension tube, nasal piece, two mouthpiece styles, five medication sups, one air filter and base, carrying tote, detailed English/Spanish instruction manual and FAQ pamphlet.



## Electronic Lice Comb

### Chemical Free Solution

**DETECTS & DESTROYS LICE ON CONTACT - CONVENIENT BRIGHT LED SPOTLIGHT**

- Small electronic charge safely kills adult lice on contact
- Quiet operation, no buzz or electronic hum
- Removable metal comb with insulated comb tips
- Two operation modes 0 on, on with LED light
- Bright LED spotlight for use on dark hair or in low-light settings

- Louse detection red light LED alert
- Built-in cleaning brush for clearing tines
- Ready-to-use: 1 AAA battery pre-installed
- Unit size: 3" x 2.5" x 1", Weight 1.5 oz.

#15-001 - Electronic Lice Comb



## Dexter Dragon™ & ClawDia Kitty™ **NEW!**

### Pediatric Compressor Nebulizer System

- Piston-style compressor pump
- Treatments delivered in 8-10 minutes
- Deep-set carrying handle
- Built-in nebulizer holder
- Coordinating storage tote for each
- Maximum compressor pressure: 36 psi
- Compressor air flow: 6-8 lpm
- Nebulization particle size .5-10 microns
- Unit weight: less than 4 pounds
- Kitty unit dimensions: 7-1/2"L x 4-1/4"W x 4-1/2"H
- Dragon unit dimensions: 7-1/2"L x 4-1/4"W x 4-1/2"H
- Latex-free



**Complete Nebulizer System:** Compressor, nebulizer, angled mouthpiece, child mask, 7 ft. air tubing, five air filters, storage tote, detailed English/Spanish instruction manual and FAQ pamphlet.

#11-510 - Dexter Dragon Pediatric Compressor Nebulizer System

#11-512 - ClawDia Kitty Pediatric Compressor Nebulizer System

**FUN AND FRIENDLY DESIGN  
FAST AND EFFECTIVE MEDICATION DELIVERY  
ENCOURAGES ACTIVE INHALATION**

## Nice-N-Cool™ 360° Gel Sleeve **NEW!**

Easy Roll On To Use Hot or Cold Therapy - No Straps  
Compression Treatment for Pain and Swelling

- Revolutionary gel sleeve surrounds treatment area and delivers soothing comfort and compression
- Helps relieve pain and swelling
- Durable clinical grade polyurethane gel sleeve
- Pliable gel remains flexible and conforms to body contours
- Non-toxic, latex free
- Includes a cotton compression sleeve to prevent direct contact to skin



- Easy to use: freeze, refrigerate, hot water or microwave
- Small - 3" - 10"; Medium - 10" - 15"; Large Fits Limb Circumference 15" - 21"

#24-955 Finger, 1" ID X 4" L

#24-956 Small, 4" ID X 6" L (Hand-Wrist-Arm)

#24-957 Medium, 5" X 6" L (Ankle-Foot-Elbow)

#24-958 Large, 6" X 6" L (Feet-Calf-Knee)



**KEEPS YOU COOL**  
**NO REFRIGERATION REQUIRED**  
**READY TO USE**

#24-950 Nice-N-Cool™ Gel Mat

## Nice-N-Cool™ Gel Mat **NEW!**

- Revolutionary gel core absorbs body heat
- Provides cooling relief for one hour,
- Decreases body temperature to promote good sleep
- Helps relieve night sweats and hot flashes
- Can safely come in contact with skin or placed under a sheet
- Designed to be used most anywhere, over and over again
- Blue self-cover with non-toxic gel center
- Hand wash only, air dry

**Size 15.35" x 11.5"**

<b>A</b>			
Aids to daily living . . . . .	25-35	Foot exerciser . . . . .	19
Alternating pump & pad . . . . .	19	Foot rest . . . . .	16
Angora products . . . . .	50	Foot stool . . . . .	21, 22
Arm Slings. . . . .	38	Forearm crutches . . . . .	7
Auto Aids . . . . .	36	<b>G</b>	
Auto grip . . . . .	36	Gait belt . . . . .	24
<b>B</b>		Gel cushions. . . . .	39-42
Back sponges. . . . .	29	Gel Sleeves. . . . .	61
Back supports. . . . .	38	Gowns . . . . .	52
Bariatric products . . . . .	20, 21	Grab bars . . . . .	16
Bath brushes. . . . .	29	Grip Alert. . . . .	18
Bath mat . . . . .	16	<b>H</b>	
Bath rail. . . . .	12-16	Hair shampoo-er . . . . .	29
Bath safety treads . . . . .	16	Hair stand . . . . .	34
Bath & shower seats . . . . .	14, 15, 21	Hand held shower . . . . .	16
Bed boards. . . . .	22	Handi-Exerciser. . . . .	10
Bed & chair riser . . . . .	24	Heating Pad . . . . .	35
Bed pads . . . . .	19, 24	Heel & elbows pads . . . . .	24
Bed rails & Accessories . . . . .	9, 22	Heel saver. . . . .	53
Bed trays . . . . .	19	Hip/Knee replacement kits . . . . .	28
Bed wedges . . . . .	44	Hot water bottles. . . . .	37
Bibs . . . . .	30	<b>I</b>	
Blanket support . . . . .	22	Ice bags . . . . .	32
Blood Pressure & Pulse Monitor . . . . .	57-58	Incontinent products . . . . .	51
Body positioner . . . . .	47	Industrial back supports. . . . .	38
<b>C</b>		Invalid rings . . . . .	39
Canes. . . . .	5, 6, 7, 19	I.V. stands . . . . .	10
Cane accessories . . . . .	5, 6, 7, 8	<b>K</b>	
Cane tip . . . . .	2, 5, 7	Knee pillows & wedges . . . . .	44, 45
Call bells . . . . .	24	Knee scooter . . . . .	7
Car Seat Belts. . . . .	1, 20	Knee warmers. . . . .	50
Cards, Card holders . . . . .	32	<b>L</b>	
Cast, bandage protectors . . . . .	48	Lap trays . . . . .	19
Cast shoes . . . . .	48	Latex foam cushion . . . . .	42
Cervical collars . . . . .	38	Leg lifter . . . . .	26
Cervical pillows . . . . .	45, 46	Lice Comb . . . . .	60
Clothing Protectors . . . . .	30	Long handle brush. . . . .	29
Coccyx cushions. . . . .	410, 42	Lotion applicator . . . . .	29
Commodes. . . . .	12, 18	Lumber back supports. . . . .	37, 40, 46
Commode pails. . . . .	12	<b>M</b>	
Contour fitted sheets . . . . .	48	Magnifiers . . . . .	31
Convuluted Pads/Cushions . . . . .	19, 39, 41, 44	Mattress clamp . . . . .	10
Crutches. . . . .	7	Mattress protectors . . . . .	49, 50
Curb Ramp . . . . .	11	Medication planner . . . . .	34
Cushions . . . . .	39-42	Medi-timer. . . . .	34
Cutlery . . . . .	31	<b>N</b>	
<b>D</b>		Nail Clipper . . . . .	35, 37, 52
Decubitus pads. . . . .	19, 24	Nebulizer Systems. . . . .	60, 61
Diabetic Skin Care. . . . .	55	Neck Cushions . . . . .	45, 46
Diabetic Socks . . . . .	55	<b>O</b>	
Digital Thermometers. . . . .	59	Orthopedic softgoods . . . . .	38
Door hinge . . . . .	24	Overbed tables . . . . .	9
Draw sheet . . . . .	50	Overdoor traction sets . . . . .	10
Dressing Aids . . . . .	24, 26, 27	Oxygen cart & Accessories . . . . .	3, 10
<b>E</b>		Oxygen Regulators . . . . .	56
Elastic supports. . . . .	37	<b>P</b>	
Exercise pulley set. . . . .	10	Page magnifier . . . . .	31
<b>F</b>		Pails . . . . .	12
Face Masks . . . . .	56	Patella knee strap . . . . .	38
Floor traction . . . . .	10	Patient gowns . . . . .	52
Foam Collars. . . . .	38	Pedal exerciser . . . . .	10
Foam ring cushions . . . . .	39	Personal care products . . . . .	29
Foot Brush . . . . .	34	Pill cutter/crusher. . . . .	34
Foot care products . . . . .	53-54	Pillows . . . . .	45, 47
		Plastic ware. . . . .	23
		Playing cards. . . . .	34
		Post-op shoes . . . . .	47
		Posture Supports . . . . .	37
		Pouches . . . . .	4
		Power putty. . . . .	32
		Pulse Oximeter . . . . .	57
		<b>Q</b>	
		Quad canes . . . . .	7, 20
		<b>R</b>	
		Raised toilet seats . . . . .	13
		Reachers . . . . .	25
		Rib belts . . . . .	38
		Rollators . . . . .	1, 20
		Rubber/Flannel sheeting . . . . .	49
		Rubber rings . . . . .	39
		<b>S</b>	
		Saf-er grip. . . . .	16, 17
		Scissors . . . . .	37
		Seat belt . . . . .	1
		Seat-lifter. . . . .	19
		Sheets, fitted. . . . .	49
		Shoe horns . . . . .	27
		Shoe laces . . . . .	26
		Shopping cart . . . . .	22
		Shower holder. . . . .	16, 17
		Shower massager . . . . .	35
		Shower mats. . . . .	16
		Sleep Apnea Products. . . . .	56
		Smoker's apron. . . . .	30
		Sock & stocking aid. . . . .	26
		Stethoscopes . . . . .	57
		Suction foot rest . . . . .	16
		Suction tub bars . . . . .	17, 18
		Swivel seat cushion. . . . .	21, 36
		<b>T</b>	
		Tennis elbow splint . . . . .	38
		TENS Units . . . . .	58
		Toilet aid . . . . .	33
		Toilet safety rails. . . . .	12, 13, 15
		Toilet seats, padded . . . . .	13
		Traction . . . . .	10
		Transfer benches. . . . .	21
		Transfer boards . . . . .	11
		Transport bags . . . . .	22
		Transport chair. . . . .	1
		Trapeze set . . . . .	10
		Travel Cart & Seat . . . . .	22
		Tub bars . . . . .	17, 18
		TV listener. . . . .	35
		<b>U</b>	
		Underpads . . . . .	49, 51
		Uplift seats . . . . .	19
		<b>W</b>	
		Walker accessories . . . . .	1, 2, 3, 4, 19
		Walker basket . . . . .	3
		Walker Glides . . . . .	2
		Walkers. . . . .	2, 7, 20
		Waterproof sheeting . . . . .	49
		Wheelchair accessories. . . . .	4, 8
		Wheelchair cushions . . . . .	41, 42, 43
		Wheelchair ramps . . . . .	11
		Wheelchair trays . . . . .	8
		Whirlpool. . . . .	15
		Wrist brace . . . . .	38

Call Toll-Free (800) 457-7648 (912) 466-0022 Fax Toll Free (800) 536-2017 (912) 466-9884

e-mail: [rosecare@bellsouth.net](mailto:rosecare@bellsouth.net)

[www.rose-healthcare.com](http://www.rose-healthcare.com)