



# Nina

The Nina is a classic, free-standing bathtub, updated with all the modern amenities. Not only a feast for the eye but the body as well.

### Available Sizes:

72"L x 44"W x 22"D  
90 Gallons



### Acrylic Tub – construction features

Acrylic models finished in 1/8" thick layer of deep lustrous acrylic.  
Extra thick reinforced fiberglass.  
Pre-wired pump on pump platform (standard pump location only)  
Integral E-Z Level platform facilitates installation.  
Non-skid bottom.

### PVC Systems – include:

**8 Fully** directional adjustable PVC jets  
**Anti-vortex** safety suction.  
**Color** matched system trim  
**Hydrozone** ozone sanitation system  
**Rigid PVC** piping  
**Self draining** pump and system  
**Soft Touch** electronic on/off control with 30-min. integral timer  
**2.25 HP** Single Speed Pump  
**Cable** waste & overflow

### Hydro Systems – Options:

**Available** as Tub only, Thermal Air, Whirlpool or Combo  
**Microban** Antibacterial Protection  
**Extra** High Density Fiberglass  
**No Skirt** (optional)  
**Custom** jet and pump locations  
**Plated** Metallic finish  
**Additional** directional Jets  
**Swirling**, Rotating, or Jumbo Jets  
**Micro** Therapy Jet  
**Integral** Waste & Overflow  
**1.5 HP** Variable Speed Pump (digital temperature display optional)  
**Electronic** low water protection  
**In-line** Heater  
**Chromatherapy-LED** Lighting System  
**Chromatherapy-LED** Mini Spotlights  
**Mood** Light  
**Grab** Bars

**Neck Masseur** Pillow  
**Hydro Fusion**  
**Hydro Coat**  
**Hydro Express** quick ship

### Approvals & Listings

Commonwealth of Massachusetts  
UPC & USPC - US & Canada







# Nina

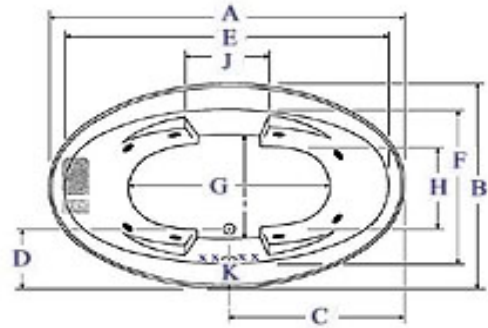

Must be set in Mortar Base



Edge Detail

-  Pump motor
-  Jets
-  Anti-vortex suction
-  Overflow location

**AS SHOWN:**  
Whirlpool option w/ standard jets

**ALSO AVAILABLE:**  
Soaking Tub Only, Whirlpool,  
Thermal Air, Combo

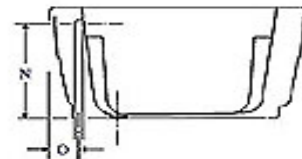
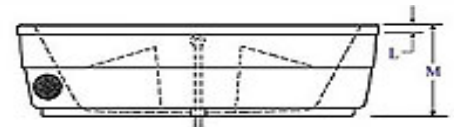

Model	GC	AC	A	B	C	D	E	F	G	H	I	J	K	L	M	N	O
7244	N/A		72"	44"	36"	12¾"	64½"	32½"	46"	24"	28"	17"	4¾"	2½"	22"	19"	5½"
<b>Amp</b>		<b>Volt</b>		<b>Breaker</b>			<b>Dedicated Service</b>					<b>Jet</b>		<b>Pump</b>		<b>Wat.Cap.</b>	
13.5		120		20 amps			GFCI Protected					8		2.25		90 gal.	

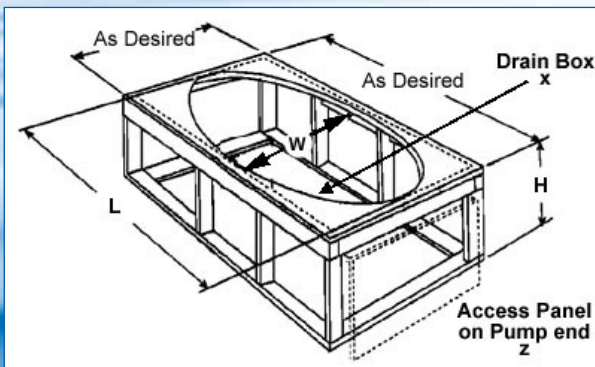

Island Drop-In			
Model	(L)ength	(W)idth	(H)eight Finish
7244	70"	42"	19½"

*Disclaimer: Certain options or altering the pump/blower location may cause the pump/blower to extend beyond the tub decking. For cutout dimensions wait for unit to arrive. All specifications subject to change without notice.*