

WINDSTER™
www.windsterhood.com

5101 Commerce Drive
Baldwin Park, CA 91706
TEL: (626)962-8600
FAX: (626)962-8669

© Windster Hoods, Inc.
Specifications subject to change without notice.

WINDSTER™

www.windsterhood.com

ISLAND HOOD

**OPERATION
MANUAL**

RA-36SS RA-42SS

For residential and indoor use only.



Please read and save this guide through before using your range hood
Store the guide away in a safe place so that you will know where it is
when you want to refer to it

Table of Contents

A. Important Safety Instructions	P.1
B. Safety Notes	P.3
C. Tools and Materials Required	P.5
D. Range hood and main parts	P.5
E. Installation of telescopic stack	P.7
F. Installation of chimney duct cover	P.8
G. Installation of island hood	P.8
H. Connect power supply	P.8
I. Installation of duct work	P.9
J. Turn power on	P.9
K. Installation flow chart	P.10
L. Use and care	P.12
M. Maintenance instruction	P.13
N. Halogen light replacement	P.13
O. Troubleshooting	P.14
P. Specifications	P.14
Q. Parts layout diagram	P.15
R. Circuit diagram	P.16
S. Diagrams	P.17

WARNING

Due to sharp edge, please wear "Safety Workman Gloves"
for installation, cleaning, light bulb changing and
dismantling to reduce the risk of any bodily injuries.

Safety Workman Gloves

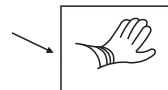

WINDSTER™

Defective Products:

All products will be inspected, tested, and carefully packed by the manufacturer before shipping to customers. Products that are damaged during transit can only be exchanged for the same product, under the condition that the customer must get a RMA (Return Merchandise Authorization) from Windster. When products are received defective, you must notify us within the 3 business days of receiving the package. Replacement products are only shipped when the RMA is issued. NO EXCEPTIONS.

Return Policy

Windster offers only the best and highest quality products. If you are not satisfied with your purchase, please contact us within 3 business days of product arrival to obtain a Return Merchandise Authorization (RMA). Returns sent without a RMA will not be accepted. There will be a 25% re-stocking fee for every returned items. Shipping fee will also be deducted from the original purchase price. When returning a package, please include a copy of your purchase receipt. Use the original shipping box and packing materials and completely remove or cover the original shipping label. Make sure that products are in brand new condition, uninstalled, un-drilled, and contain everything that came with the package as when you first received it. If any parts or manuals are missing, we have the right not to accept the return.

We suggest that you use a traceable and reputable carrier of your choice to ship your return. Your credit or refund will be processed within 10-14 business days from the date we receive your return.

WINDSTER™

Limited Warranty

Windster Hoods Inc. warrants this product against defects in material or workmanship as follows:

- 1) **Labor:** For a period of one (1) year from the date of purchase, if this product is determined to be defective, Windster will repair or replace the product, at its option, at no charge. After the warranty period, you must pay for all labor charges. During the “labor” warranty period there will be no charge for labor.
- 2) **Parts:** In addition, Windster will supply, at no charge, new or rebuilt replacements in exchange for defective parts for a period of two (2) years. After the warranty period, you must pay for all parts costs. During the “parts” warranty period, there will be no charge for parts

You must carry-in or mail-in your product during the warranty period. This warranty only applies to products purchased and serviced in the United States or Canada.

What Is Not Covered By These Warranties:

- 1) Conditions and damages resulting from any of the following:
 - Improper installation, delivery, or maintenance.
 - Any repair, modification, alteration or adjustment not authorized by the manufacturer or an authorized service dealers.
 - Misuse, abuse, accidents, or unreasonable use.
 - Incorrect electric current, voltage or supply.
 - Improper setting of any control.
 - Improper chemical cleaning.
- 2) Light Bulbs
- 3) Products purchased for commercial or industrial use (such as in a hotel, office, restaurant, or other business)
- 4) Damage due to earthquake, flood, storm, etc.

A. Important Safety Instructions

Read and Save These Instructions

1. Make sure the power is off before installing, wiring or maintenance.
2. Please keep the range hood clean.
3. To get the best performance, the vertical clearance between the cook - top and the range hood should range from 28" to 32".

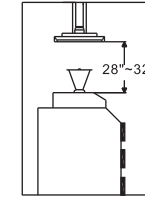

Optimum Rangehood height

Ducting method

- A. This rangehood must be connected outside either through the roof (fig a) or through the wall (fig b)

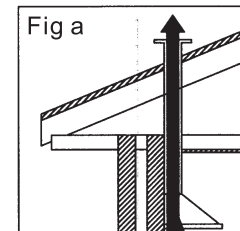

Ducting through the roof

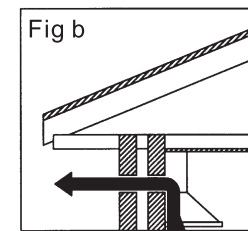

Ducting through the wall

- B. Blockage of exhaust will cause
- a. Uneven fan speed.
 - b. Reduced oil collection in one cup only
 - c. Could cause possible vibration.

CAUTION- To reduce the risk of fire and to properly exhaust air, be sure to duct air outside. Do not vent exhaust air into spaces within walls or ceilings or into attics crawl spaces or garages.

WARNING- To reduce the risk of fire or electric shock, do not use this fan with any solid- state speed control device.

IMPORTANT SAFETY INSTRUCTIONS

WARNING – To reduce the risk of fire, electric shock, or injury to persons, observe the following:

DO NOT spray any liquid form cleaner on hood surface including lights and control switch. To clean the range hood, spray liquid form cleaner directly onto cleaning cloth for hood cleaning.

- A. Use this unit only in the manner intended by the manufacturer.
If you have questions, contact the manufacturer.
- B. Before servicing or cleaning unit, switch power off at service panel and lock service panel to prevent power from being switched on accidentally.
When the service disconnecting means cannot be locked, fasten a prominent warning device, such as a tag, to the service panel.
- C. Installation work and electrical wiring must be done by a qualified person(s) in accordance with all applicable codes and standards, including fire-rated construction.
- D. Sufficient air is needed for proper combustion and exhausting of gases through the flue(chimney) of fuel burning equipment to prevent back drafting. Follow the heating equipment manufacturer's guideline and safety standards such as those published by the National Fire Protection Association (NFPA), and the American Society for Heating, Refrigeration and Air Conditioning Engineers(ASHRAE),and the local code authorities.
- E. When cutting or drilling into wall or ceiling, do not damage electrical wiring and other hidden utilities.
- F. Ducted fans must always be vented to the outdoors.

CAUTION- For general ventilating use only. Do not use to exhaust hazardous or explosive materials and vapours.

WARNING- To reduce the risk of a range top grease fire:

- A. Clean ventilating fans frequently. Grease should not be allowed to accumulate on fan or filter.
- B. Always turn hood on when cooking at high heat or when cooking flaming foods.
- C. Never leave surface units unattended at high settings. Boilovers cause smoking and greasy spillovers that may ignite and spread if hood is used. Heat oils slowly on low or medium settings.
- D. Don't leave your range unattended when cooking.
- E. Use proper pan size. Always use cookware appropriate for the size of the surface element.

WARNING- To reduce the risk of injury to persons in the event of a range top grease fire, observe the following:

A- **SMOTHER FLAMES** with a close- fitting lid, cookie sheet, or metal tray, then turn off the burner. Be careful to prevent burns. If the flames do not go out immediately, **EVACUATE AND CALL THE FIRE DEPARTMENT.**

B- **NEVER PICK UP A FLAMING PAN-** You may be burned.

C- **DO NOT USE WATER** including wet dishcloths or towels- a violent steam explosion will result.

D- **USE AN EXTINGUISHER ONLY IF:**

1. You know you have a **CLASS ABC** extinguisher, and you already know how to operate it.
2. The fire is small and contained in the area where it started.
3. The fire department is being called.

WARNING- To reduce the risk of fire, use only metal ductwork.

B. Safety Notes

1. All electrical work must be done in accordance with local and/or national electrical code as applicable for safety. This product must be grounded if your are unfamiliar with methods of installing electrical wiring, secure the services of a qualified electrician.
2. Turn off power at service entrance before installing wiring or servicing this product. (120 volt for range hood. 220 volt for electric range if any)
3. Turn off power to avoid risk of fire, electric shock or injury to person for cleaning or maintenance such as lubrication.
4. Fireplaces, gas furnaces, water heaters and the like require proper flow of combustion air and exhaust. Make sure this flow is not altered when using any exhaust fan.
5. Please read specification label on product for further information and requirements.
6. Please wear "Safety Gloves" for installation, cleaning, light bulb changing and dismantling to reduce the risk of any bodily injuries.

Wiring to Power Supply

SAFETY WARNING

RISK OF ELECTRICAL SHOCK. THIS RANGE HOOD MUST BE PROPERLY GROUNDED. MAKE SURE THIS IS DONE BY SPECIALIZED ELECTRICIAN IN ACCORDANCE WITH ALL APPLICABLE NATIONAL AND LOCAL ELECTRICAL CODES. BEFORE CONNECTING WIRES, SWITCH POWER OFF AT SERVICE PANEL AND LOCK SERVICE PANEL TO PREVENT POWER FROM BEING SWITCHED ON ACCIDENTALLY.

Connect the electrical wires.

- Connect three wires (black, white and green) to house wires and cap with wire connectors. Connect according to color :

black to black, white to white, and green to green as shown on Figure A.

- If necessary, hide the electrical wire connections, push wires back into the wiring box. Access the wire connections underneath the hood.

Make sure wires do not slip between motor or any moving parts to prevent any damages.

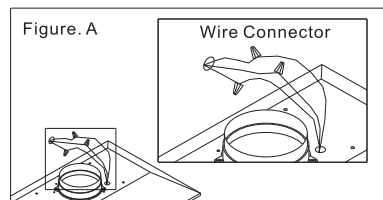

S. Diagrams

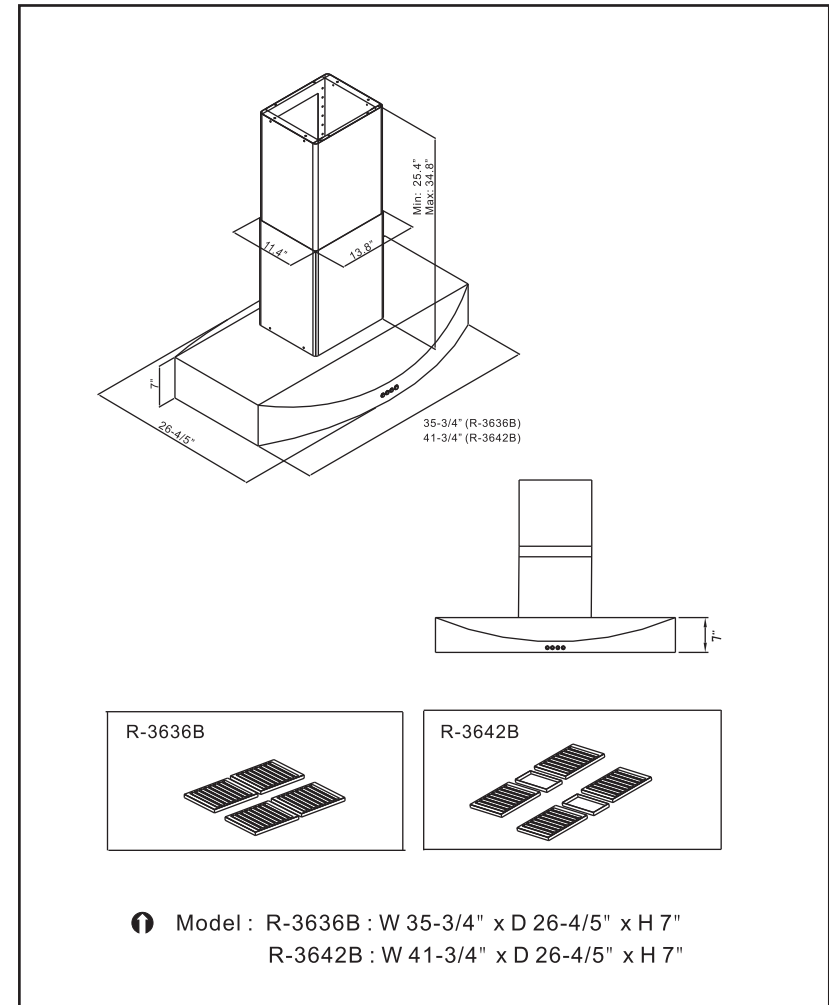

R. Circuit Diagram

Fig.14 Details the internal electrical circuit of this range hood unit. Any faults with this unit should only be attended to by a qualified technician.

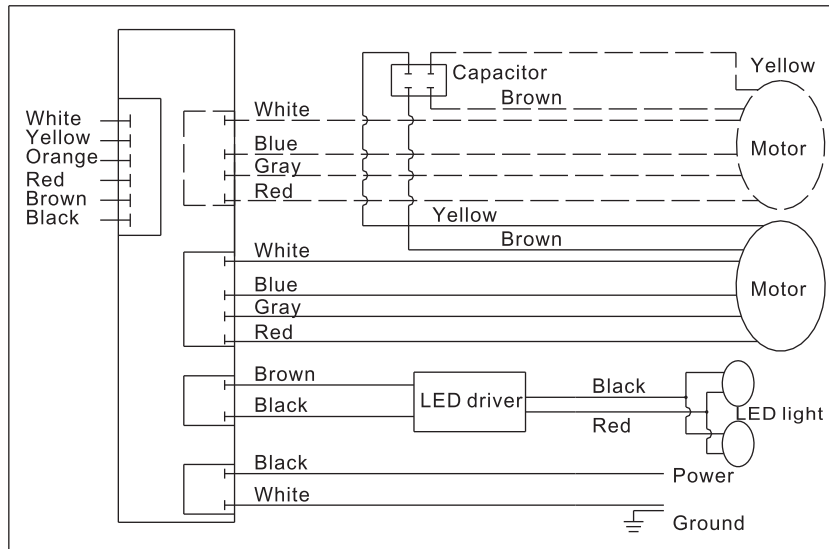

Fig.14 Electrical Schematic Diagram

C. Tools and materials Required

- One common screwdriver.
- Plier (for opening electrical knockout).
- 2 Piece cross framing lumber (2"x10")to reinforce the ceiling drywall.
- Electrical wire and supplies to comply with local cords.
- Electrical power drill.

D. Range hood and wain parts

BOX A

1. Operation manual
2. Rangehood
3. Duct ring

2. Rangehood

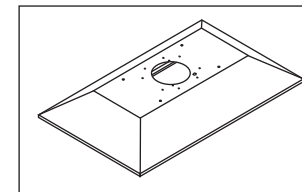

3. Duct ring

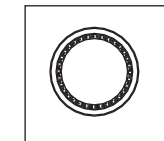

6"~7" duct ring conversion

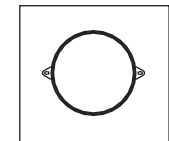

6" duct ring standard

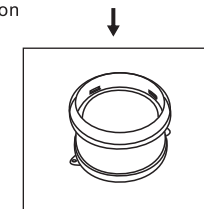

BOX B

1. Mounting templet
2. Screws
3. Telescopic stack
4. Chimney duct cover (inner / outer)

1. Mounting templet

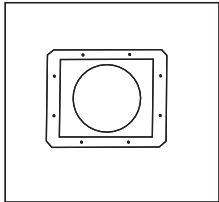

3. Telescopic stack

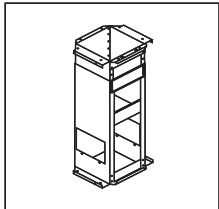

4. Chimney duct cover (inner / outer)

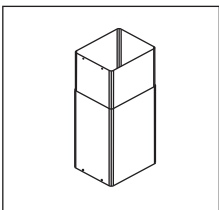

2. Screws

A. Plastic screw 8pcs



B. 4x32 mm screw 8pcs



C. 4x8 mm screw- 16pcs



D. 3/16x3/8 mm screw- 8pcs



Q. Parts Layout Diagram

MODEL :
R-3636B
R-3642B

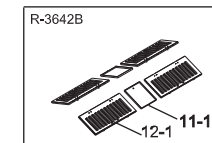
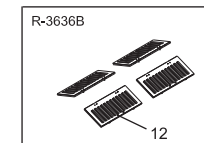
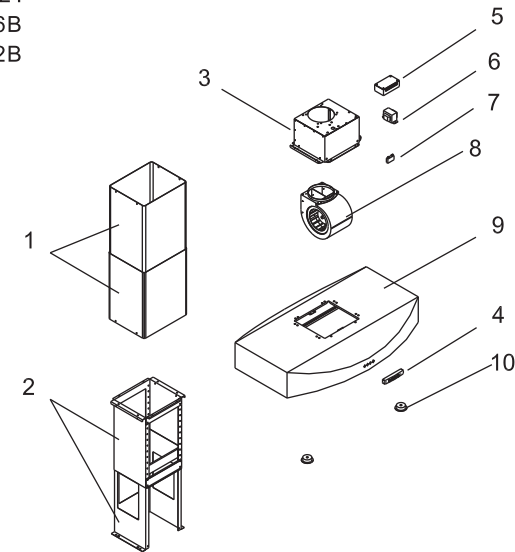

1	Duct Cover	7	Capacitor
2	Duct Cover-Mounting Bracket	8	Squirrel Cage
3	Motor Chamber	9	Hood Casing
4	Control Board	10	Halogen Light
5	Processor Board	11	Wide
6	Transformer	12	Baffle Filter

O. Troubleshooting

Symptom	Correction
Fan are not operatable.	A. Check power source to see if it is normal. B. Check power inlet plug to see if it is plugged firmly into it's socket.
Illuminating indicator lamp burned out light.	A. Disconnect the power source. B. Check lamp bulb, replace it with a new one if it is burned out.
Hood vibrates.	A. Check for damaged vanes. B. Check if exhaust duct is secured.

P. Specifications

Specifications	R-3636B / R-3642B
Revolutions	Low - 620±50 R.P.M. High - 1660±50 R.P.M.
Consumption - Motor	180W
Consumption - Lamp	20W / 12V Halogen Light x 2
Rotation	Squirrel Cage
Diameter Exhausting Duct	6" / 7" Round Outlets adapter
Voltage	120V / 60 Hz
Appearance Treatment	Brushed Stainless Steel

* Specifications subject to change without prior notice.

E. Installation of telescopic stack

Important: At least 2 or more persons to install this hood
Duct cover and extension duct cover fitment may vary depend on the mounting height of the range hood.

Material preparation :

- a. Mounting templet
- b. Telescopic stack
- c. 2 pieces cross framing lumber (2" x10")
- d. 8 (4x32mm), 8 (4x8mm) screws
- e. Duct connector conversion (for 7" pipe use only)

1. On the ceiling, please check the desired position, and be sure to mark the appropriate centerline of range or cooktop.
(Note: check from range/cooktop to the ceiling) (Fig.1)
2. Take the mounting templet and check centerline then mark on the ceiling to position the mounting templet and mark the size of exhaust duct, make sure the end of exhaust outlet on the wall or roof is 6" or 7".
(Fig.2)

Note : The standard duct connector size is 6", however the end of exhaust outlet may be either 6" or 7", if the end exhaust outlet is 7", you have to use a duct conversion and 7" pipe.

3. After marking the mounting templet, remove and keep it, make exact size (6" or 7") of exhaust duct on the ceiling. (Fig.3)
4. Cut and remove the ceiling drywall.
5. If the ceiling is not strong enough, it must install 2 (2"x10") cross framing lumbers between joists. (Fig.4)
Note: The island hood is totaled over 50 lb
6. Replace the mounting templet in the position of the ceiling joists and cross framing lumbers, install telescopic stack to the ceiling joists and cross framing lumbers with 8 (4x32mm) screws as provided, ensure all screws were driven firmly. (Fig.4)

7. Make sure the above step 4,5 and 6, then measure the exact length, slide the telescopic stack then fastened by 8 purchase screw (4x8mm) as provided. (Fig.5)

F. Installation of chimney cover

Material preparation :

- a. Chimney duct cover
- b. 4 (4x8mm) screws

8. Slide the chimney duct cover into the telescopic stack then push out the inner chimney duct cover to top of telescopic stack fastened by 4 (4x8mm) screws provided. (Fig. 6)

G. Installation of island hood

Material preparation :

- a. Island hood
- b. 8 (3/16x3/8mm) screws

9. Hold the outer chimney duct cover up by temporary screws then continue to install island hood to end of telescopic stack. (Fig.7)

10. Fasten 8 (3/16x3/8mm) screws from end of telescopic stack to the island hood.

Important ! Must ensure every screws were fasten tightly. (Fig.7)

H. Connect power supply

Important: Installation must be carried out by an authorized or qualified technician and in accordance with all applicable national and local codes.

11. Remove the wire box cover please refer fig 8. Remove the knockout from the wire box.

M. Maintenance Instruction

1. Maintenance should be important than repair. Please take care of the needed maintenance in order to secure and extend the excellent functions and using life.

Note:

Before repairing the range hood. Disconnect the power source.

2. After using the machine, wipes the machine by neutral detergent in order to keep it clean and maintain the appearance with brightness and sanitation.
3. When the level of dirty oil of the collector reached 4/5 of height, it has to be removed in order to avoid overflowing and pollution.

N. Replace the LED Light

Before replacing LED light ensure the unit is switched off, when you want to change the LED light, please always wear working gloves.

1. Using suitable tool (small slotted screw driver) gently pry off the LED light set.
2. Taking off the wire connecter with LED light set.
3. Replace a new LED light set and reconnect the wire to the connector.
4. Before push back the original LED light position, test the LED light.

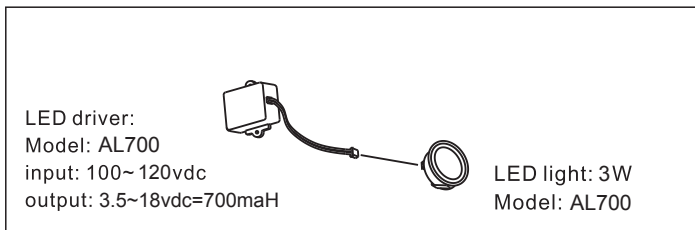

NOTE : For LED light replacement, you may not find the appropriate LED lights from market, please contact with distributor(s)/dealer(s).

L. Use and Care

Note: Operate switches (Fig.13)

Switch 1 : LED Fan speed indicator.

Ⓜ - Low speed ⓘ - High speed

Switch 2 : Speed switch (Three speed fan)

Switch 3 : Light switch

Switch 4 : Power switch and delay switch.

Push once : Delayed shut off.

Push twice : Immediate shut off.

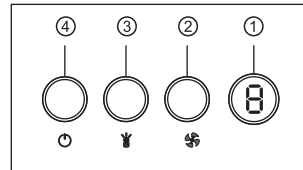

Fig.13

Note:

Range hood should be turn on either before or the same time when cooking begins. After cooking, range hood should be kept on for about 3 more minutes for complete ventilation of cooking odor.

Care Instruction:

Please always pull the plug out before cleaning or dismantling, wear 'Safety gloves' to reduce the risk of any injuries.

Exterior: Can be clean with any type of non-abrasive detergent and a clean cloth. "Green Pad" or any metal type cleaning pad is not recommended for exterior.

12. Insert the power cord to the wire box and connect the conduit connector in the wire box, check 3 wires in different colors, black, white and green, then connect to match the colors ie,

Black to Black White to White Green to Green

13. Before close the wire box cover, must make sure there are no wires between cover and box to avoid of short circuit.

I. Installation of duct work

14. Following the exact size of exhaust duct for either 6" or 7", use the right size of round pipe to connect the duct by collar on the hood. For standard end exhaust outlet 6" you can only use standard duct connecter and 6" round pipe, meanwhile for end exhaust outlet 7" you have to plus a duct conversion and 7" round pipe. (Note: the duct conversion is available for both 6"and 7" round pipe, 6" round pipe is installed inside the inner ring, 7" round pipe is installed outside the inner ring)

15. Use the duct tape to seal pipe and duct to make sure no air leakage.

16. Loosen the temporary screws as step. 9 then slide the lower section of chimney duct cover downward carefully, make sure it sits around the hood appropriately.

17. Fasten the chimney duct cover to the hood with 4 (4x8mm) screws as provided by hand screwdriver only.

J. Turn power on

18. Before turning the power on, check all the glass cover of lights and halogen lights were all fixed right in their position and sockets,

K. Installation flow chart

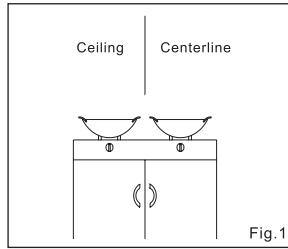

Fig.1
Mark the appropriate centerline

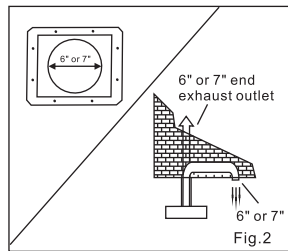

Fig.2
Mark the exact size (6" or 7") of exhaust duct on the ceiling. (Check the installation area is applicable for 6" or 7" end exhaust outlet)

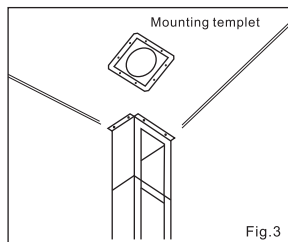

Fig.3
After centerline checking then mark on the ceiling to position the mounting templet

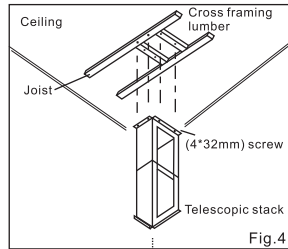

Fig.4
1. Install 2 cross framing lumber between joist
2. Replace and mark the mounting templet in the position of the ceiling joists and cross framing lumbers then install the telescopic stack.
3. Install telescopic stack to ceiling surface (if the surface is strong enough) or cross framing lumber with 8 (4x32mm) screws.

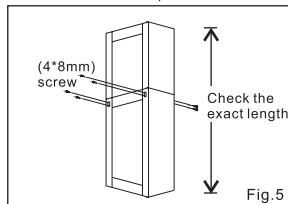

Fig.5
Slide the telescopic stack to the exact length then fastened by 8 pcs screws on the middle

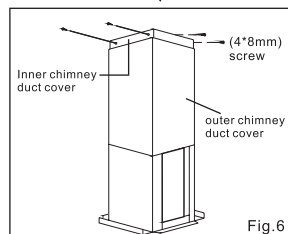

Fig.6
Slide the chimney duct cover into the telescopic stack then push out the inner chimney duct cover to top of telescopic stack fastened by 4 (4x8mm) screws.

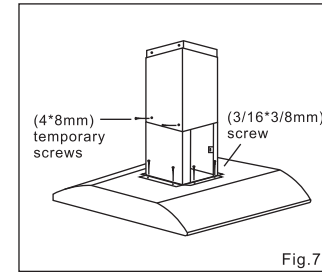

Fig.7
Hold the outer chimney duct cover up by temporary screws then continue to install island hood to end of telescopic stack by fastened 8 (3/16x3/8mm) screws.

Important! Need at least 2 persons for this installation job.

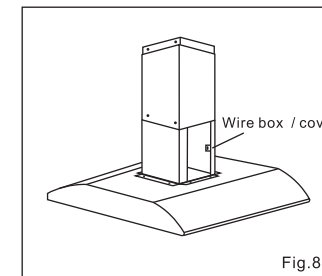

Fig.8
Remove the wire box cover and knockout from wire box. Connect the conduit connector in the wire box the connect to match the colors

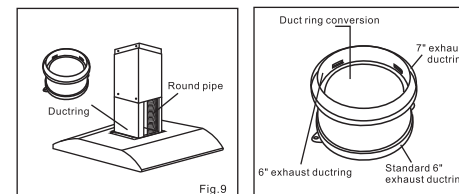

Fig.9
Use the right size of round pipe to connect the duct by collar.

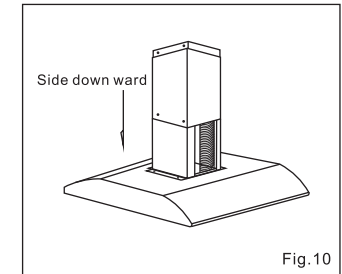

Fig.10
1. Loosen temporary screw (Fig.7)
2. Slide the lower section of chimney duct cover downward

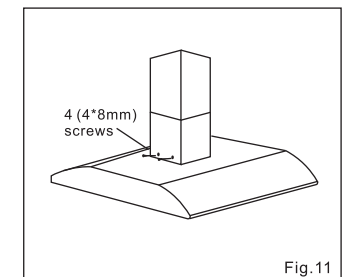

Fig.11
Fasten the chimney duct cover to the hood with 4 (4x8mm) screws

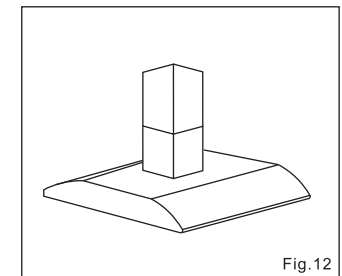

Fig.12
Finished Picture.