

### Parts

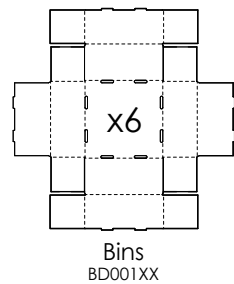

### Instructions

**1** Lay side **b** on the ground with the slots facing up. Insert the shelves **c** and top/bottom **e** pieces. Press firmly on the shelves to secure them in place. **DO NOT slide anything into final position yet!**

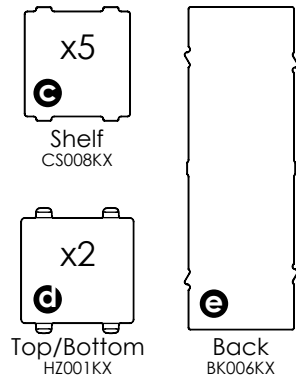
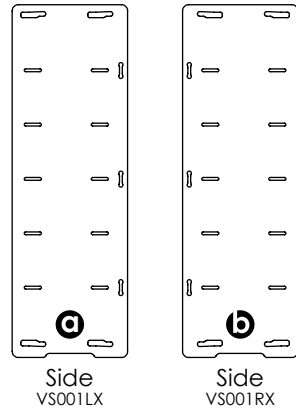
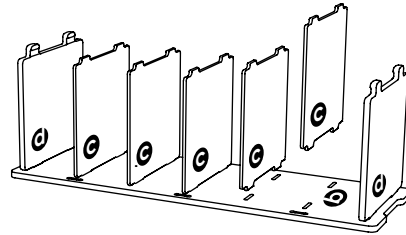

**Note:** Every tab has a groove on one side. Every slot has an indent. The groove in the tab needs to line up with the indent in the slot to work correctly.

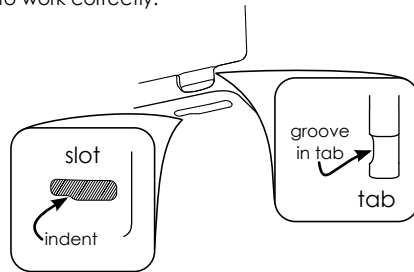

**2** Insert the back **e** followed by the final side **b**. Make sure that all of the slots align with each of the shelf tabs and press them firmly together.

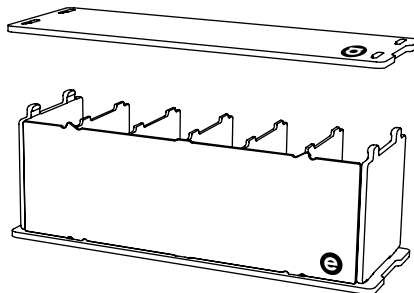

**3** **CAREFULLY** hold both sides firmly and rotate the shelf to its back.

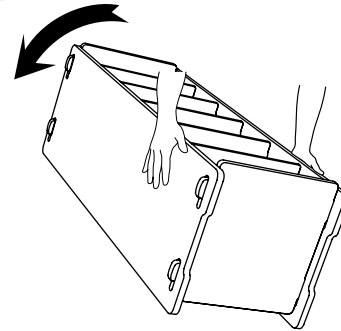

**4** Press down on the top/bottom **e** pieces to lock them in securely. Ensure that the tabs are pressed securely into the slots.

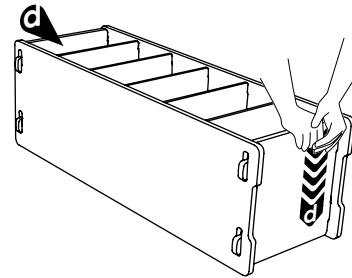

**Note:** Pressing the tabs into the slots is what creates the Tension Lock. This will require some effort. **STAND UP, POSITION YOURSELF ABOVE THE JOINT AND USE YOUR WEIGHT TO PRESS DOWN.** Lock your arms if you need to for extra force.

The tabs need to be pressed almost to the end, as shown below.

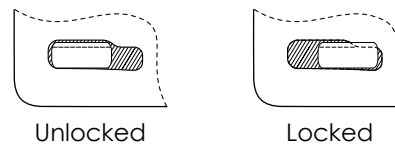

### X Disassembly

To disassemble, lay the shelf face down on the ground. Press down on the top and bottom pieces to release the Tension Lock. If necessary, try placing a book under the corners of the shelf to make releasing the Tension Lock easier.

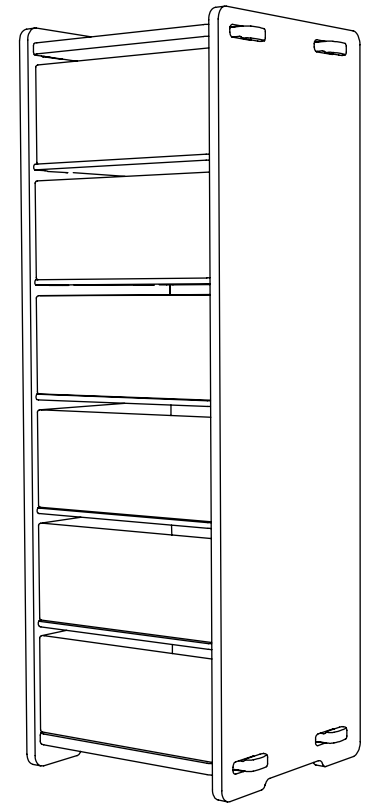
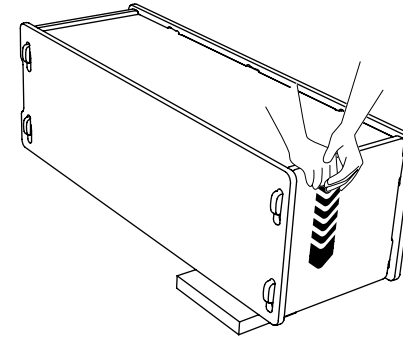

Assemble bins (see instructions printed on bins) and slide into place.

If the furniture seems unstable, ensure that the Tension Lock tabs are completely pressed into place. If you have any concerns, contact us at: [www.sprout-kids.com/contact](http://www.sprout-kids.com/contact)

### Need More Help?

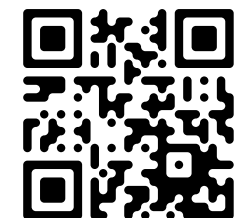

Scan the QR Code or visit us online at [www.sprout-kids.com](http://www.sprout-kids.com) for more ideas, assembly instructions, videos, to request replacement parts, and to see what's new at Sprout.

[sqo.so/drwa](http://sqo.so/drwa)