



VISUAL COMMUNICATIONS COLLECTION





Peter Pepper had a vision: accessories designed to enliven the work environment and assist employees to be more productive. In 1952 that vision became a reality. ⚙️ The mandate was clear: the strength of this vision must start by demanding the highest caliber of design, producing an inspired product line offering unparalleled selection. ⚙️ Peter Pepper Products has consistently delivered high quality products, identifying real solutions and meeting the price specifications of your most complex problems, yet never compromising the integrity of the design. ⚙️ But Peter Pepper's vision was also one of responsiveness and synergy. Establishing relationships based on partnership and performance, Peter Pepper initiated a new standard of attention to the client relationship, defining customer service as customer commitment. ⚙️ At Peter Pepper Products, we will continue to strive to maintain the spirit of Peter Pepper's original vision. ⚙️ Design and Performance, diversity and practicality. Vision is fact. Peter Pepper Products.

VISUAL COMMUNICATION PRODUCTS

Whether putting together a presentation, teaching a seminar or training a management team, the Tactics® and MiniMint® Message and Communication Boards are designed specifically to meet your needs, and bring a whole new level of ease, attractiveness and convenience to the world of corporate and educational components. From conference centers to glass enclosed combination tack boards, track systems and directories, Peter Pepper Products provides the elements that can turn an average presentation into a standout event.



TABLE OF CONTENTS

VISUAL COMMUNICATION PRODUCTS

Glass Enclosed Boards	04
Writing Surfaces	08
Glass Writing Surface	10
Fabric Tackable Boards	11
Combination Boards	12
Conference Centers	16
Directories	19
Tactics Plus® Wall Track System	20
Tactics® Wall	24

COMMUNICATION & MESSAGE BOARDS

GLASS ENCLOSED BOARDS



MM-CW-GL-7236
GLASS ENCLOSED COMBINATION BOARD

Semi-Circular



MMD-2-RA 3624
GLASS ENCLOSED BULLETIN BOARD
36w x 24h x 1 5/8d

Semi-Circular



MM-CW-GL-RA 4848
GLASS ENCLOSED COMBINATION BOARD
48w x 48h x 1 5/8d

Quarter Round



MMD-4-RB 3024
GLASS ENCLOSED MESSAGE BOARD
30w x 24h x 4d

COMBINATION BULLETIN/TACK BOARDS

GLASS ENCLOSED BOARDS

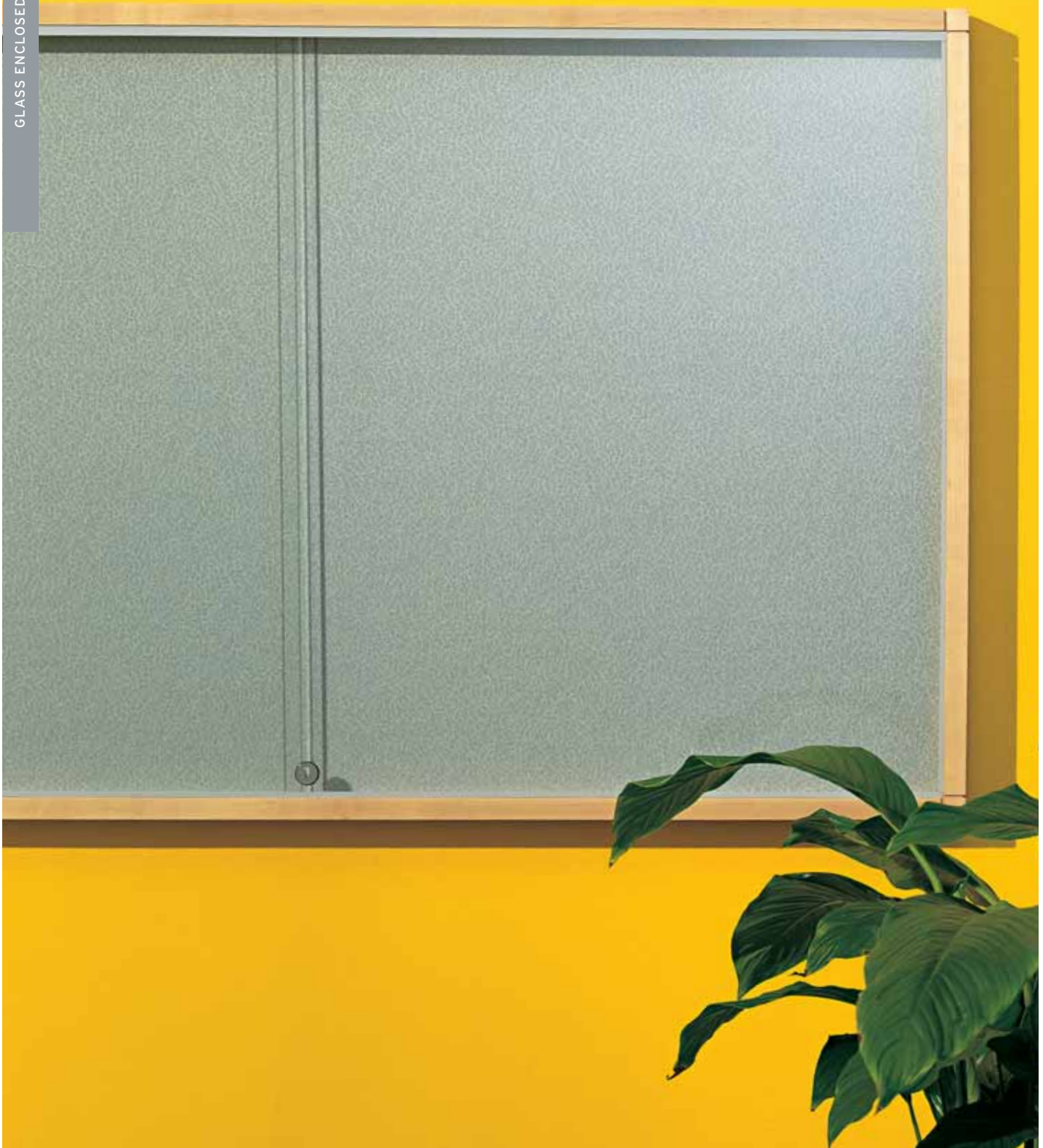

WB-CW-GL-6036L-MA
GLASS ENCLOSED BULLETIN/TACK BOARD



Radius-R



WB-CW-GL 7236R-MA
GLASS ENCLOSED COMBINATION BOARD
72w x 36h x 2 1/2d



Linear-L



WB-CW-GL 3624-CH
GLASS ENCLOSED BULLETIN BOARD
36w x 24h x 2 1/2d

VISUAL COMMUNICATION PRODUCTS COMMUNICATION & MESSAGE BOARDS,
COMBINATION BULLETIN TACK BOARDS

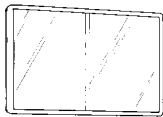

Bulletin/Tack Boards
Aluminum framed
Glass enclosed

24 x 18 up to 48 x 48
Custom sizes

Fabric
Cork
Steel
COM



Combination Boards
Aluminum & Wood framed
Open framed & Glass enclosed

36 x 24 up to 96 x 48
Custom sizes

Fabric
Cork
Steel
Magnetic
COM

TACTICS® WRITING AND TACKABLE SURFACES

TACTICS® COMMUNICATION BOARDS

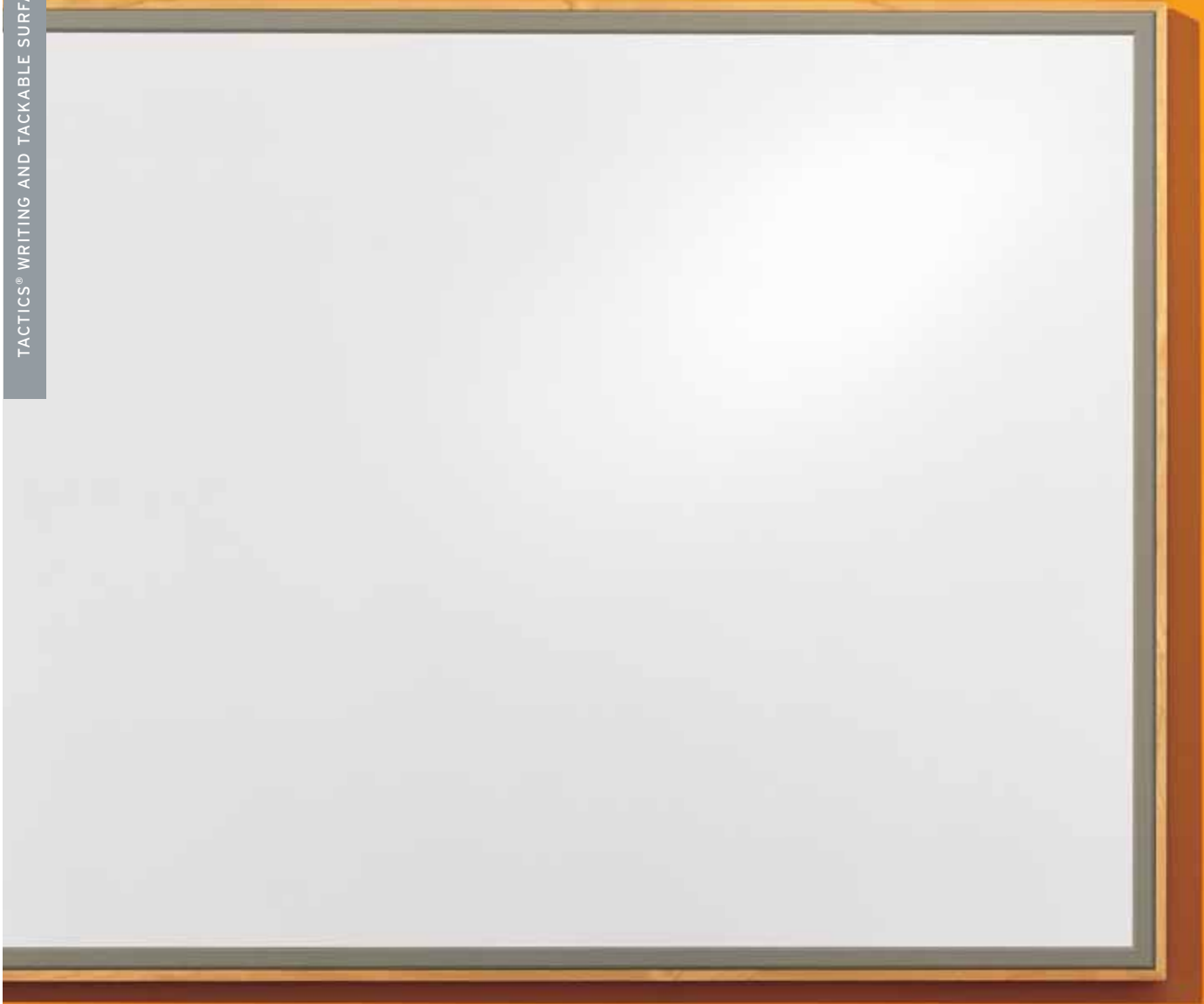

TC 7236-1-MA WRITING SURFACE

Mini-Quarter Round



MM-LMB-RA 4836
WRITING SURFACE
48w x 36h x 1d

Radial-3



TC 7236-3-AL
WRITING SURFACE
72w x 36h x 1 1/4d

Beveled-2



TC 7236-2-CH
WRITING SURFACE
72w x 36h x 1 1/4d

TACTICS® WRITING SURFACES



TC-4836-9-MM
WRITING SURFACE
48w x 36h x 1 1/8d

Linear-9



GB 3624 GLASS WRITING SURFACE, 5792 PEN RAIL
Tempered safety glass with flat polished edges.
36w x 24h x 1d

Mounts to wall with 1" diameter natural aluminum standoffs.



ROOM	PATIENT	DOCTOR	NURSE	ROOM	PATIENT	DOCTOR	NURSE
401				401			
402				402			
403				403			
404				404			
405				405			
406				406			
407				407			
408				408			
409				409			
410				410			
411				411			
412				412			
413				413			
414				414			
415				415			
416				416			
417				417			
418				418			
419				419			
420				420			

DATE	TIME	PROVIDER	PROBLEM	DIAGNOSIS	PLAN	ASSESSMENT	REMARKS
10/10/2017	08:00	DR. J. SMITH	HEALTHY				
10/10/2017	09:00	N. JONES					
10/10/2017	10:00	DR. J. SMITH					
10/10/2017	11:00	N. JONES					
10/10/2017	12:00	DR. J. SMITH					
10/10/2017	13:00	N. JONES					
10/10/2017	14:00	DR. J. SMITH					
10/10/2017	15:00	N. JONES					
10/10/2017	16:00	DR. J. SMITH					
10/10/2017	17:00	N. JONES					
10/10/2017	18:00	DR. J. SMITH					
10/10/2017	19:00	N. JONES					
10/10/2017	20:00	DR. J. SMITH					
10/10/2017	21:00	N. JONES					
10/10/2017	22:00	DR. J. SMITH					
10/10/2017	23:00	N. JONES					



TC 4836-5 WRITING SURFACE
with Custom Silk Screened Graphics
48w x 36h x 1d



TS TACK STRIP
Wood framed, 24" up to 96" wide
Custom size, Fabric, COM

CUSTOM SILK SCREENED GRAPHICS
Silk screened graphics are available on writing surfaces. Please submit your requirements.

WS/TF



TF 4836
FABRIC TACKABLE PANEL
48w x 36h x 3/4d

Radius-6



FB-4836-6
FABRIC TACKABLE PANEL
48w X 36h X 1d

Half-Round-7



FB-4836-7-MA
FABRIC TACKABLE PANEL
48w x 36h x 7/8d



Radius-8

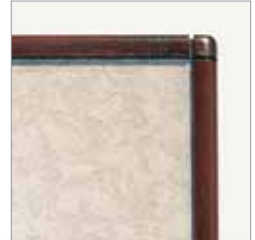

FB4836-8
FABRIC TACKABLE PANEL
48w x 36h x 1 1/8d



Slim Trim-5



PB 3624-5
COLOR CORK TACKABLE PANEL available in 4 colors
36w x 24h x 1d



Slim Trim-5



FT 7236-5
COMBINATION BOARD WITH DISPLAY RAIL
72w x 36h x 1d

Slim Trim-5



UC3636-5 COMBINATION BOARD
 Porcelain writing surface inner panel
 Fabric tackable outer panel
 36w x 36h x 1d

Design: Lynnette M Tedder, IIDA, CID, LEED AP, AAHID. For patient rooms at Ronald Reagan UCLA Medical Center

Bullnose-4



**FTF 7236-4-K
 COMBINATION BOARD**
 72w x 36h x 1 1/4d

Mini-Quarter-Round



**MM-CW-RB 4836
 COMBINATION BOARD**
 48w x 36h x 1d



IB4012 MA
40w x 12h x 1 3/4d



IB1240 CH
12w x 40h x 1 3/4d

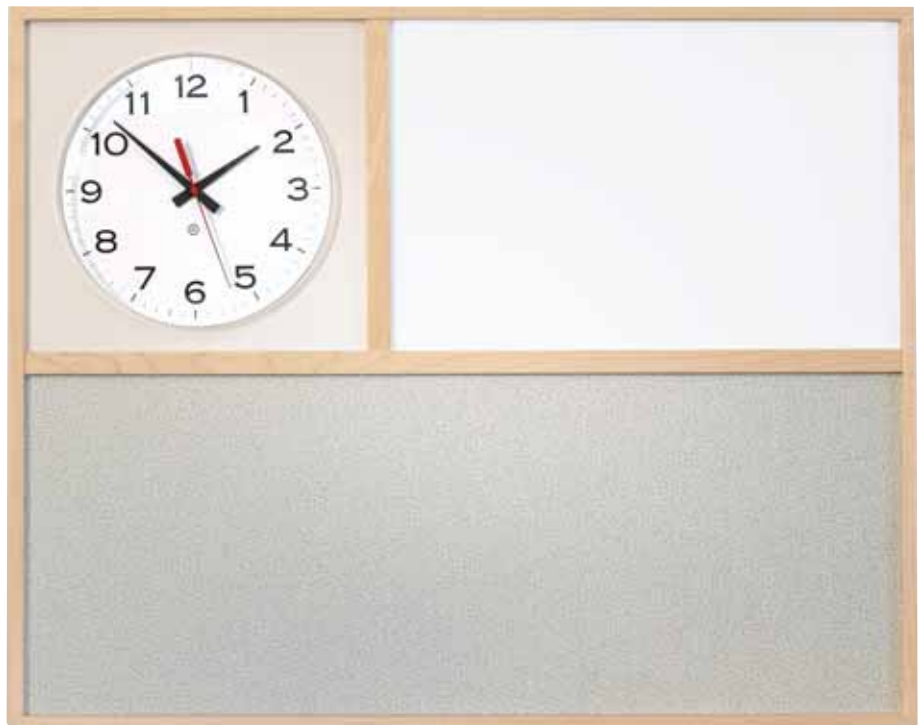

IB3024 MA
30w x 24h x 1 3/4d

Patient Room Information Board combines clock, magnetic porcelain writing surface and fabric or COM tackable panel in one enclosure. Optional wireless synchronization system is offered using CDMA master and wireless secondary receiver clocks. Contact Factory. Frame finish: Oak, Medium Oak, Cherry, Natural Maple, Mahogany or Walnut. Custom configurations available.

TACTICS® COMMUNICATION BOARDS

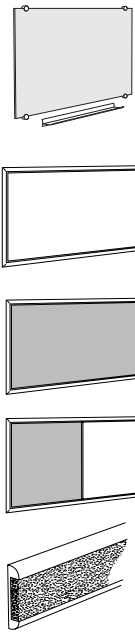

Glass Writing Surface	24 x 36 up to 96 x 48 Custom sizes	Tempered safety glass with flat polished edges Mounts with 1" diameter aluminum standoffs
Writing Surfaces-Porcelain	12 x 12 up to 144 x 48 Custom sizes	Color: White Graphics: 2 x 2 grid Custom graphics
Tackable Panels	12 x 12 up to 96 x 48	
Combination Boards	48 x 36 up to 144 x 48 Custom sizes	Fabric/COM Cork Color cork Writing surface
Tackable Strips Wood framed	24 up to 96 wide Custom sizes	Fabric COM

11 FRAME PROFILES IN WOOD AND ALUMINUM:



Lineal-1



Beveled-2



Radial-3



Bullnose-4



Slim Trim-5



Radius-6

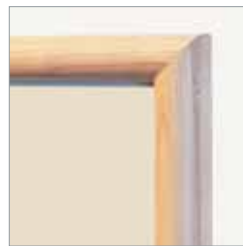

Half Round-7



Radius-8



Linear-9



Mini-Quarter Round

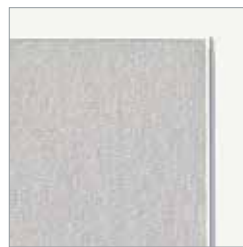

WS/TF



TS-Tack Strip

Fabric Selection: Please see p. 26.
Please see Price List for full specifications, ordering information and pricing.

CONFERENCE CENTERS



CCB 4848
BULLNOSE CONFERENCE CENTER



Radius



CC 4848 RADIUS
CONFERENCE CENTER



Bullnose



CCB 4848 CH BULLNOSE
CONFERENCE CENTER



Bullnose



CCB 4848 BULLNOSE
CONFERENCE CENTER



WS/TF



7675 CONFERENCE CENTER

Semi-Circular MM-CLD-GL-RB



Quarter Round MM-CLD-RA



MM-CLD-RA 1836
MM-CLD-GL-RB 3624
DIRECTORY



Elliptical ED-1, ED-2



ED-2-GL 32689Z COM
FREESTANDING DIRECTORY

Changeable Letter Directories
Wall mounted and freestanding, open framed or glass enclosed. Black rubber letter board with anodized aluminum frame. Optional fabric, COM and custom sizes available. Fabric Selections: please see page 26.

TACTICS PLUS® ADVANCED TRAINING SYSTEM

TACTICS PLUS® WALL TRACK SYSTEM



The Tactics Plus® System is designed for productive, effective, professional training and conferencing presentations.

Dual wall track allows bi-passing panels for easy positioning and almost doubles the presentation capacity.

Lightweight panels are reversible and framed in natural anodized aluminum or any PPP color.

Any panel may be corner mounted for better viewing and space utilization.

Dry erase porcelain panels are available in white.

2" Grid writing surfaces aid in graphic presentations.

Tackable panels are available in fabric or COM.



7710/7770



7710 WRITING SURFACE
36w x 42h x 3/4d



7710 WRITING SURFACE
7730 FABRIC TACKABLE PANEL
36w x 42h x 3/4d



7770 FLIP CHART ASSEMBLY
30w x 42h x 7d



7771 PAD HOLDER
magnetic, attaches to any
procelain surface



7783 PROJECTION SCREEN, retractable
50w x 50h
7784 PROJECTION SCREEN, retractable
60w x 60h



5782 DISPLAY RAIL, 5792P PRESENTATION RAIL



WS 4841 WRITING SURFACE - LEVEL 'O' with 2" grid
Level 'O' panels may be mounted directly under
track for additional surfaces.
48w x 41h



7690 PEN RAIL 5789 PEN RAIL
magnetic

TACTICS PLUS® ADVANCED TRAINING SYSTEM

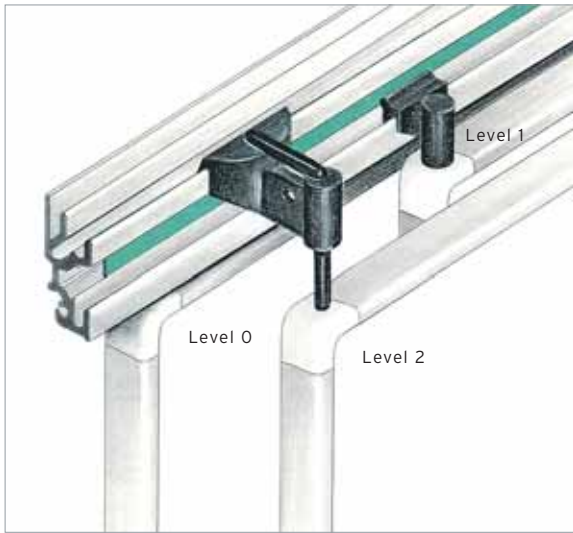

MODEL 7700 WALL TRACK



Level 0 Level 1 Level 2

Level '0' panel is wall-mounted directly under track.

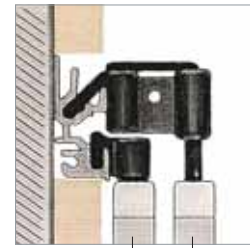

Level 1 Level 2

Wall track may also be recessed into the wall surface.



Level 1



Level 2

Level 1 & Level 2 hangers may be positioned for reversing any panel or for mounting any panel across the corner.

The lower roller adjusts to glide smoothly over wall surface.



Level 1



Level 2

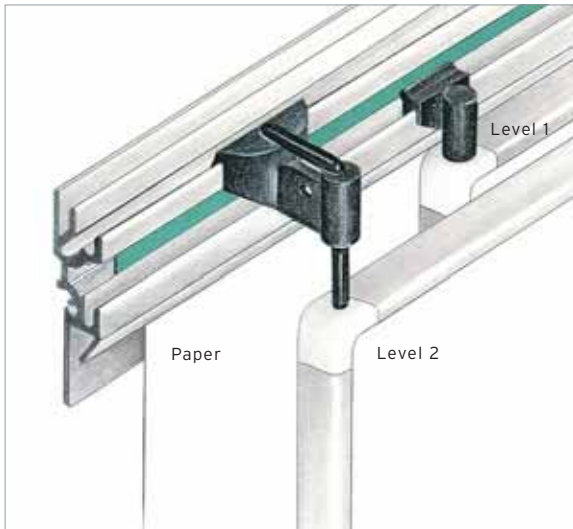

MODEL 7705 WALL TRACK (with integrated display rail)
Slide sheet under rollers to insert

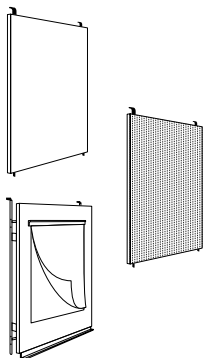
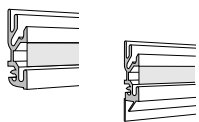

Wall Track	96 x 2.5		2 Level track
Wall Track with integrated display rail	96 x 3.25		Natural anodized aluminum
	Track Mounted W x H	Wall Level 'O' Mounted W x H	Aluminum frames available in natural anodized aluminum or any PPP color
Writing Surfaces	36 x 42 48 x 42 72 x 42	up to 120 x 41	White Optional 2 x 2 Grid Graphics
Tackable Panels	36 x 42 48 x 42		Fabric or COM
Flip Chart Assembly	30 x 42 x 7		With magnetic pad holder

Please see Price List for full specifications, ordering information and pricing.
Fabric Selections: please see p. 26.



The Tactics® Wall is a multiple panel writing surface system designed for large floor to ceiling applications. With the Tactics® Wall you can create writing surface walls of any length.

The Tactics® Wall panels are framed in aluminum with durable porcelain on steel surfaces, lightweight, magnetic, and quick and easy to install.

The Tactics® Wall is installed approximately 15" above the finished floor.



TW4 192w x 84h



TACTICS® WALL PANELS
48 x 84 each
Thin joining extrusion
connects panels.

FABRICS

LIDO STYLE 2858

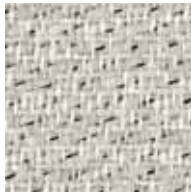

024 Oak Bluffs

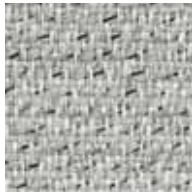

023 Cape May



010 Hermosa



030 Newport

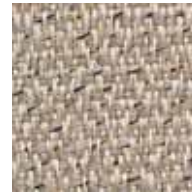

031 Smith Point



0236 Huntington

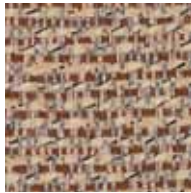

065 Bryce Canyon



013 Green Bay



051 Padre

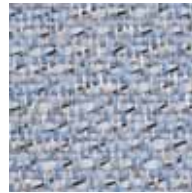

015 Moonstone

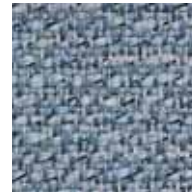

019 Balboa

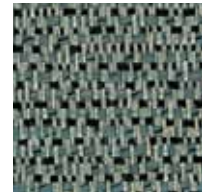

054 Pine Valley

RAKU STYLE 3548



020 Porcelain



021 Opaline

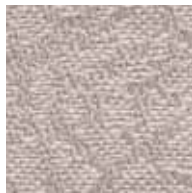

040 Prism



050 Flint



032 Tawny



015 Cinder

ZIRCONIA STYLE 3583



080 Sandstone



022 Moonstone



021 Opal



020 Peridot

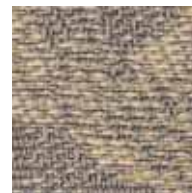

090 Guilden



041 Smoky Quartz

Interface Fabrics

To order samples, visit online sample service: www.guilfordofmaine.com/samplecenter.
Optional: COM - Customers Own Materials are available on most tackable panels.

COLOR CORK AND NATURAL CORK



2187



2186

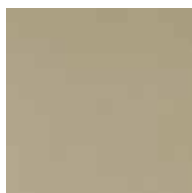

2067



2202



Natural Cork

Forbo Linoleum Inc. samples available on request at 800 842-7839, x712.

Due to printing limitations, the textures illustrated approximate actual colors.



PETER PEPPER PRODUCTS
EXPRESSIVE ESSENTIALS™

PETER PEPPER PRODUCTS, INC.
17929 S. Susana Road
PO Box 5769
Compton, CA 90224-5769

T: 800 496 0204
T: 310 639 0390
F: 310 639 6013
W: www.peterpepper.com
E: info@peterpepper.com

10

VISUAL COMMUNICATIONS COLLECTION

