



Read and Save These Instructions
All Hoods Must Be Installed By A Qualified Installer

INSTALLATION INSTRUCTIONS

WALL MOUNT LINER INSERT

Read All Instructions Thoroughly Before Beginning Installation

WARNING - TO REDUCE THE RISK OF FIRE, ELECTRIC SHOCK, OR INJURY TO PERSONS, OBSERVE THE FOLLOWING:

- A. Installation work and electrical wiring must be done by qualified person(s) in accordance with all applicable codes and standards, including fire-rated construction. Switch power off at service panel and lock the service disconnecting means to prevent power from being switched on accidentally during installation.**
- B. When cutting or drilling into wall or ceiling, do not damage electrical wiring and other hidden utilities.**
- C. Ducted fans must always be vented to the outdoors.**
- D. Sufficient air is needed for proper combustion and exhausting of gases through the flue (chimney) of fuel burning equipment to prevent back drafting. Follow the heating equipment manufacturer's guideline and safety standards such as those published by the National Fire Protection Association (NFPA), and the American Society for Heating, Refrigeration and Air Conditioning Engineers (ASHRAE), and local code authorities.**
- E. ASHRAE residential ventilation standard 62.2 limits exhaust fans (total) to a maximum of 15 CFM per 100 square feet of occupiable space, unless a back drafting test is performed or make-up air is provided. Consult a local HVAC engineer for make-up air evaluation.**

WARNING - TO REDUCE THE RISK OF FIRE, USE ONLY METAL DUCTWORK

Vent-A-Hood®

Ducting Do's and Don'ts

NEVER restrict the duct size. The single blower unit (B100) requires 6" round duct or equivalent (28 square inches), and the dual blower unit (B200) requires 8" round duct or equivalent (50 square inches). When combining ducts together, the square inch area must reflect the total square inch area of the ducts being combined. Using Vent-A-Hood transitions (back page) will ensure proper efficiency.

Blower	Duct Size	Sq. Inch Area	Vent-A-Hood Transition
Single (B100)	6" round or equivalent	28"	N/A
Dual (B200)	8" round or equivalent	50"	N/A
Single and Dual (B100 & B200)	10" round or equivalent	79"	VP562 (Optional)
Two Dual (Two B200s)	12" round or equivalent	113"	VP563 (Optional)

Do not use flexible or corrugated duct. This type of duct will restrict airflow and reduce performance. Only use smooth, galvanized, metal duct. Observe local codes regarding special duct requirements and placement of duct against combustibles. Make the duct run as short and as straight as possible with as few turns as possible. Avoid sharp-angled turns. Instead, use smooth, gradual turns such as adjustable elbows or 45 degree angled turns. For duct runs over 20 feet, increase the duct diameter by one inch for every ten feet of duct. A 90 degree elbow is equal to 5 feet of duct. Using Vent-A-Hood roof jacks or wall louvers (back page) will ensure proper efficiency. Airflow must not be restricted at the end of the duct run. Do not use screen wire or spring-loaded doors on wall louvers or roof jacks. Do not terminate venting into an attic or chimney. Where possible, seal joints with duct tape. The hood must be ducted to the outdoors without restrictions.

YES



Smooth Duct

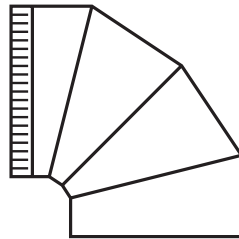

Smooth Gradual Turn

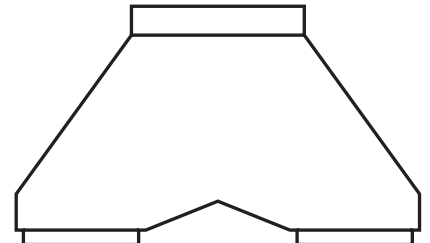

Proper Combining of Two Ducts

NO

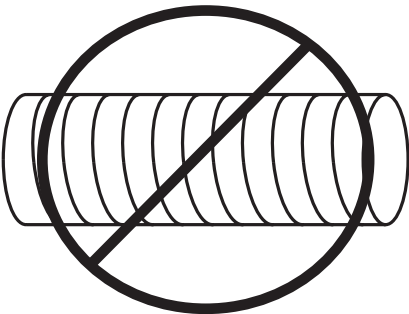

Flexible Duct

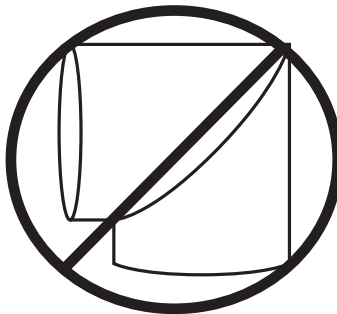

Sharp Angled Turns

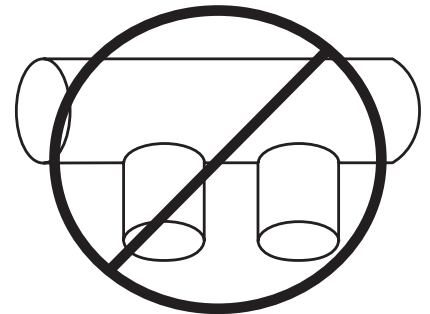

Improper Combining of Two Ducts

Vent-A-Hood®

Installation Details

- 1) Read all instructions thoroughly before beginning installation. Note: These instructions apply to standard liners only. Custom liners may require additional specification consideration.
- 2) When installing a SLD wall mount liner (19 1/4" deep), it is recommended that the bottom edge of the liner be located no more than 24" - 27" above the cooking surface for optimum performance. For PSLD and PSLB wall mount liners (22 1/2" deep), it is recommended that the bottom edge of the liner be located no more than 27" - 30" above the cooking surface for optimum performance. For custom liners, the recommended height off the cooking surface is dependent on the depth of the liner. In general, the deeper the custom liner, the higher off the cooking surface it can be, up to a maximum recommended height of 30" above the cooking surface for optimum performance.

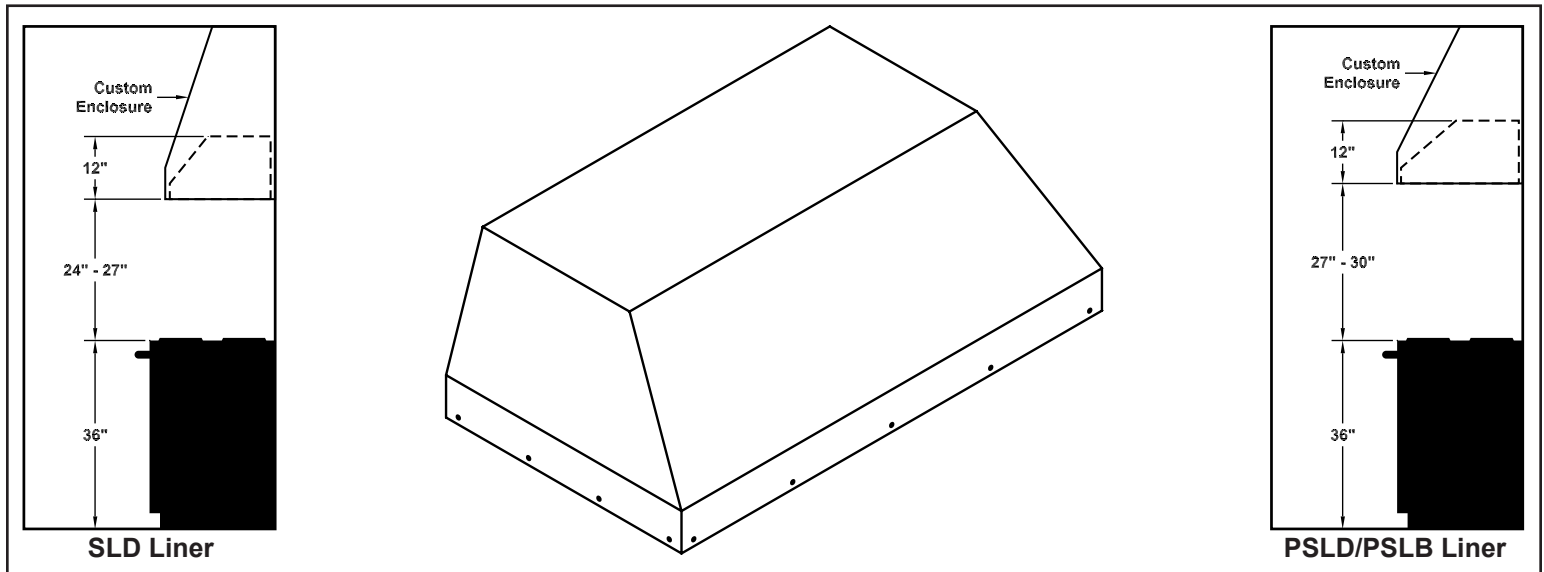

- 3) Install the duct(s) from the outside of the home down to the location of the exhaust outlet(s) on the top of the liner allowing room for the transition (if applicable). If back venting, the elbow(s) should be installed so that the non-crimped end(s) are on the inside the collar(s) of the exhaust outlet(s). If a transition is used, install duct down to the location of the transition outlet plus 1". This will allow the transition to engage 1" inside of duct. Consult the connection diagrams (next page) for further details on exhaust outlet placement.

Use duct tape to seal all joints. A complete listing of available Vent-A-Hood ducting materials is included on the back page of this instruction sheet.

Transition heights are as follows:

Single Blower (B100):

6" round duct will connect directly to the top of the liner.

Dual Blower (B200):

8" round duct will connect directly to the top of the liner.

Single and Dual Blower (B100 & B200):

6" round duct will connect directly to the top of the hood; 8" round will connect directly to the top of the hood. Optional 10" round combination transition (VP562, sold separately) is 17 1/2" tall.

Two Dual Blowers (Two B200s):

Two 8" rounds connect directly to the top of the hood. Optional 12" round combination transition (VP563, sold separately) is 16 1/2" tall.

Vent-A-Hood®

Installation Details Continued

Connection Diagram (28 3/8" - 40 3/8" Widths)

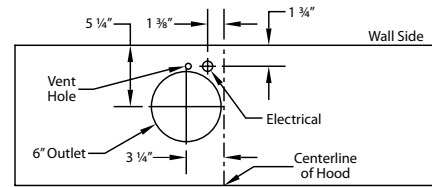

**300 CFM B100 Single Blower
(Top View)**

Connection Diagram (28 3/8" - 52 3/8" Widths)

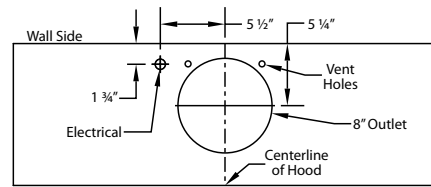

**600 CFM B200 Dual Blower
(Top View)**

Connection Diagram (40 3/8" - 58 3/8" Widths)

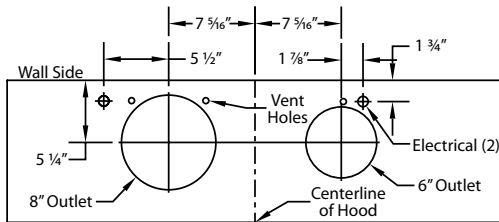

**900 CFM B200 Dual & B100 Single Blower
(Top View)**

Connection Diagram (46 3/8" - 64 3/8" Widths)

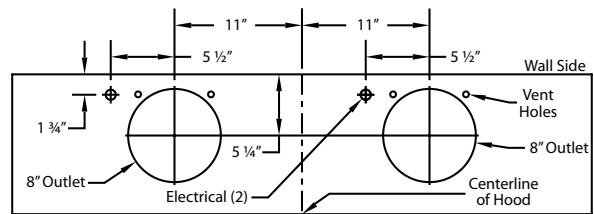

**1200 CFM Double B200 Dual Blowers
(Top View)**

- 4) Remove the hood from its packaging and place the back of the hood on the floor or countertop in front of the wall where it will hang. Save the trim kit and hardware for step 10.
- 5) Remove the shipping tape that is securing the E-Z Clean shield(s) inside the hood. Remove the E-Z Clean shield(s) by lightly pulling it toward the front of the hood. Gently close the back draft damper(s) from the top side of the hood. To remove the blower housing(s), unsnap the suitcase latches (one on each side of the housing). The housing(s) should be pulled forward and gently "tipped" to clear the blower wheel(s) and then out of the hood.

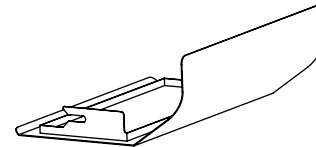
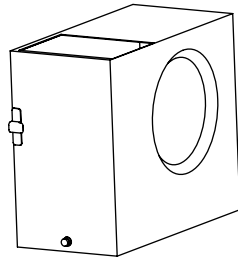
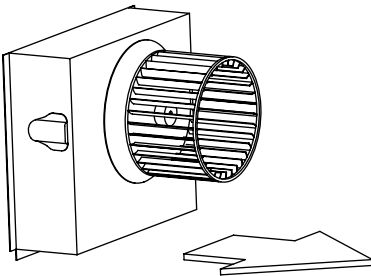

- 6) Remove the three screws retaining the blower motor(s). Unplug and remove the motor(s), taking care not to damage the blower wheel(s). It is not necessary to remove the blower wheel from the motor.

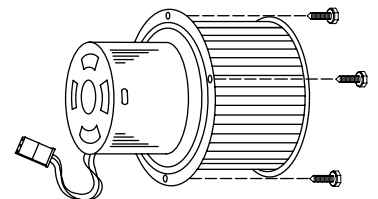

Warning: Make sure power is off and locked at the service disconnecting means on the service panel during installation.

Vent Hood®

Installation Details Continued

- 7) Install an appropriate 1/2" UL listed electrical wire clamp through each motor box electrical opening on top of the liner. Install electrical wiring from the service panel to the liner location for each motor box. Consult the connection diagrams (on previous page) for further details on electrical placement.

Model	Volts	Amps*	Hz	RPM	CFM SP@0.0"	Equivalent CFM*	CFM SP@0.1"	CFM SP@0.2"	CFM SP@0.3"	Minimum Round Duct Size	Sones#
B100 Single	115	1.5	60	1550	300	450	273	245	225	6" (28 in. ²)	5.4
B200 Dual	115	2.9	60	1550	600	900	531	480	430	8" (50 in. ²)	6.5
B200 Dual & B100 Single	115	4.4	60	1550	900	1350	804	725	655	VP562: 10" (79 in. ²)	6.3
Two B200 Duals	115	5.8	60	1550	1200	1800	1062	960	860	VP563: 12" (113 in. ²)	6.6

* Add 0.5 amp for each halogen light.

* Because the Magic Lung® blower uses centrifugal filtration rather than conventional baffle or mesh filters, the Magic Lung® blower can handle cooking equipment with higher cubic feet per minute (CFM) requirements and can deliver equivalent CFM much more efficiently than other than other filtration systems. When comparing the Magic Lung® with other blower units made by other manufacturers, use the "Equivalent CFM".

* Ratings in accordance with the Standard Test Code by the Energy Systems Laboratory of the Texas Engineering Experiment Station.

- 8) Extend wires to the liner and insert them into the electrical wire clamp on each motor box. Tighten the wire clamp(s). From inside the liner, using UL listed wire nuts, attach the "neutral" wire(s) to the white lead(s), the "hot" wire(s) to the black lead(s), and the ground wire(s) to the green lead(s) inside the motor box(es).

Warning: Do not operate hood without proper ground connection.

- 9) While aligning the duct and guiding the wires, lift the liner up into the enclosure flushing the bottom edges of the liner and the enclosure. Duct should connect together as the liner is raised into place. Note: The duct work must fit inside the exhaust collar. Wood strips may be necessary to fill any gaps between the opening and the liner if the opening in the wood surround is larger than the liner.

- 10) Install a wood screw with a countersunk washer and a flat washer into each back and side mounting hole along the bottom edge of the liner. Install only the wood screws into the front mounting holes along the bottom edge of the liner. The inner front section of the liner is not visible on wall mount liner inserts therefore, a trim strip is not necessary. Note: The hardware used in this step can be found in the liner trim kit that was previously removed from the packaging in Step 4.

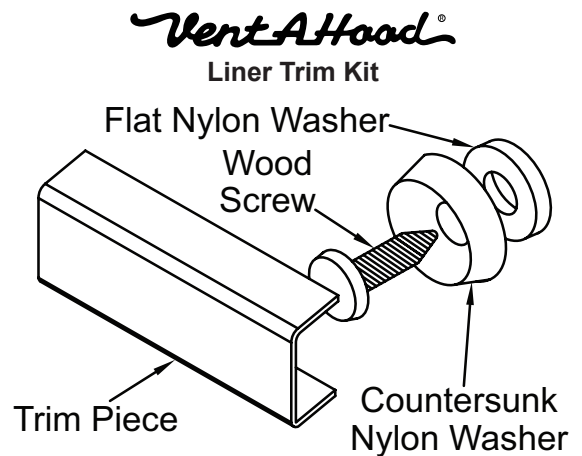

- 11) Install the trim piece for the back side of the liner (provided in the liner trim kit) by hooking one side under the bottom edges of the back countersunk washers. Snap the trim piece over the top of the countersunk washers by applying pressure upward and toward the liner wall. Repeat this process for the side trim pieces (provided in the liner trim kit). Note: It may be necessary to lightly tap the trim piece with a rubber mallet.

- 12) Plug the motor(s) into the liner and reinstall the blower motor retaining screws that were previously removed in Step 6.

- 13) Replace the blower housing(s) and the blower shield(s). Make sure that the damper(s) open and close smoothly.

- 14) Refer to the Owner Maintenance Guide Operating Instructions for proper hood operation. Test all blower and light functions to ensure they are operating properly.

VENTING

Vent-A-Hood®

ACCESSORIES

WALL LOUVER

MODEL	DESCRIPTION
VP526	6" Round
VP527	7" Round
VP528	8" Round

WALL LOUVER

MODEL	DESCRIPTION
VP554	10" Round

WALL LOUVER

MODEL	DESCRIPTION
VP555	12" Round

RECTANGULAR WALL LOUVER

MODEL	DESCRIPTION
VP538	6" x 8-1/2"
VP560	3-1/4" x 10"

LOW PROFILE ROOF JACK (MAXIMUM 4/12 PITCH)

MODEL	DESCRIPTION
VP539	6" Round
VP540	7" Round
VP541	8" Round

LOW PROFILE ROOF JACK (MAXIMUM 4/12 PITCH)

MODEL	DESCRIPTION
VP552	10" Round
VP553	12" Round

LOW PROFILE ROOF JACK (MINIMUM 4/12 PITCH)

MODEL	DESCRIPTION
VP539-HP	6" Round
VP540-HP	7" Round
VP541-HP	8" Round

LOW PROFILE ROOF JACK (MINIMUM 4/12 PITCH)

MODEL	DESCRIPTION
VP552-HP	10" Round
VP553-HP	12" Round

ADJUSTABLE ELBOW

VP513 - 8 1/2"
VP514 - 9 9/16"
VP515 - 10 5/8"

MODEL	DESCRIPTION
VP513	6" Round
VP514	7" Round
VP515	8" Round

BACK/SIDE VENT ELBOW

MODEL	DESCRIPTION
VP561	8" to 6" x 8-1/2"

3 1/4" x 10" BACK VENT ELBOW

MODEL	DESCRIPTION
VP559	3-1/4" x 10"

3 1/4" x 10" TO 7" TRANSITION

MODEL	DESCRIPTION
VP521	3-1/4" x 10 to 7"

MULTI-BLOWER TRANSITION

VP562 - 17 1/2"
VP563 - 16 1/2"
VP562 - 23 1/4"
VP563 - 30 1/2"

MODEL	DESCRIPTION
VP562	6" & 8" to 10"
VP563	8" & 8" to 12"

M1200 STANDARD TRANSITION

MODEL	DESCRIPTION
VP566	M1200 Transition

STANDARD ISLAND TRANSITION

MODEL	DESCRIPTION
VP565	5" x 16" to 8" Rnd

CLUSTER BLOWER TRANSITION

MODEL	DESCRIPTION
VP564	8" & 8" to 12"

OFFSET L & R TRANSITION FOR ISLAND BLOWERS

MODEL	DESCRIPTION
VP542	Top Left
VP543	Top Right

SIDE VENT TRANSITION L & R FOR ISLAND BLOWERS

MODEL	DESCRIPTION
VP544	Side Left
VP545	Side Right

OFFSET KIT - ROUND

MODEL	DESCRIPTION
VP529	6" Rnd to 7" Rnd

OFFSET KIT - RECTANGULAR

MODEL	DESCRIPTION
VP550	6" to 3-1/4" x 10"

"Y" TRANSITION

MODEL	DESCRIPTION
VP517	8" & 8" to 12"
VP518	6" & 8" to 12"
VP551	6" & 8" to 10"

ROUND DUCT PIPE

MODEL	DESCRIPTION
VP500	6" Round
VP501	7" Round
VP502	8" Round

3 1/4" RECTANGULAR DUCT PIPE

MODEL	DESCRIPTION
VP504	3-1/4" x 10"
VP505	3-1/4" x 12"
VP506	3-1/4" x 16"

6" RECTANGULAR DUCT PIPE

MODEL	DESCRIPTION
VP507	6" x 8-1/2"