



## WHYNTER PORTABLE AIR CONDITIONER

**MODEL# : ARC-13PG**

### **Instruction Manual**



Thank you for your purchase of this WHYNTER product. Please read this Instruction Manual carefully before using product to ensure proper use. Keep this manual in a safe place for future reference.

Thank you for choosing the Whynter portable air conditioner. Please follow the instructions given in this booklet to obtain the very best performance from your portable air conditioner and take full advantage of the many advance features that your portable air conditioner offers you. We trust that your Whynter air conditioner will provide the performance and reliability that we stand for.

Please keep this user manual in a safe place for future reference.

## ***DISPOSAL***

---



This symbol on the product or its packaging indicates that the appliance cannot be treated as normal domestic trash, but must be handed in at a collection point for recycling electric and electronic appliances. Your contribution to the correct disposal of this product protects the environment. Further information about the recycling of this product can be obtained from your local municipal authority.

## PARTS OVERVIEW

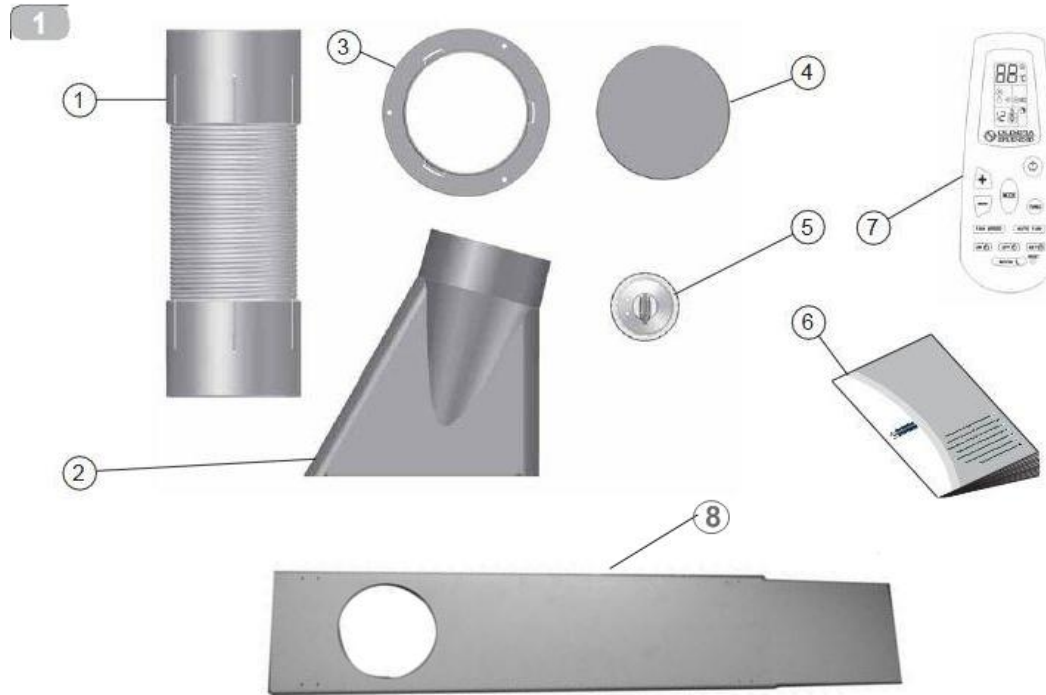

1. Exhaust hose	2. Rectangle Connector	3. Round Connector	4. Round Cover
5. Window Suction Cup	6. User Manual	7. Remote Control	8. Window Slide Bars

For this portable air conditioner to operate correctly, the hot air from the back of the unit must be vented to the outside. Please follow the instructions below for window kit installation.

1. Extend the exhaust hose (Part 1) at least 6" and insert it to the outdoor exhaust outlet at back of the air conditioner.
2. Attach the round connector (Part 3) to the other end of the exhaust hose.
3. Open your window and place the adjustable window slide bars (Part 8) to the opening of the window. Extend the Slide Bars so it covers the window opening completely.
4. Lower/Shut the window until it holds the Slide Bars are held in place tightly.
5. Attach the exhaust hose with the round connector to the round opening of the window slide bar.
6. When the air conditioner is not in use, remove the hose from the window slide bars and place the round cover (Part 4) to the round opening of the bar.
7. For non-permanent installations, such as doors or sliding doors that may need to be opened or closed, attach the rectangle connector (Part 2) to the end of the exhaust hose and place the rectangle connector at the opening of the door.
8. The window suction cup is an optional part which can be used to hold up the exhaust hose to a desired position.

## **UNIT OVERVIEW**

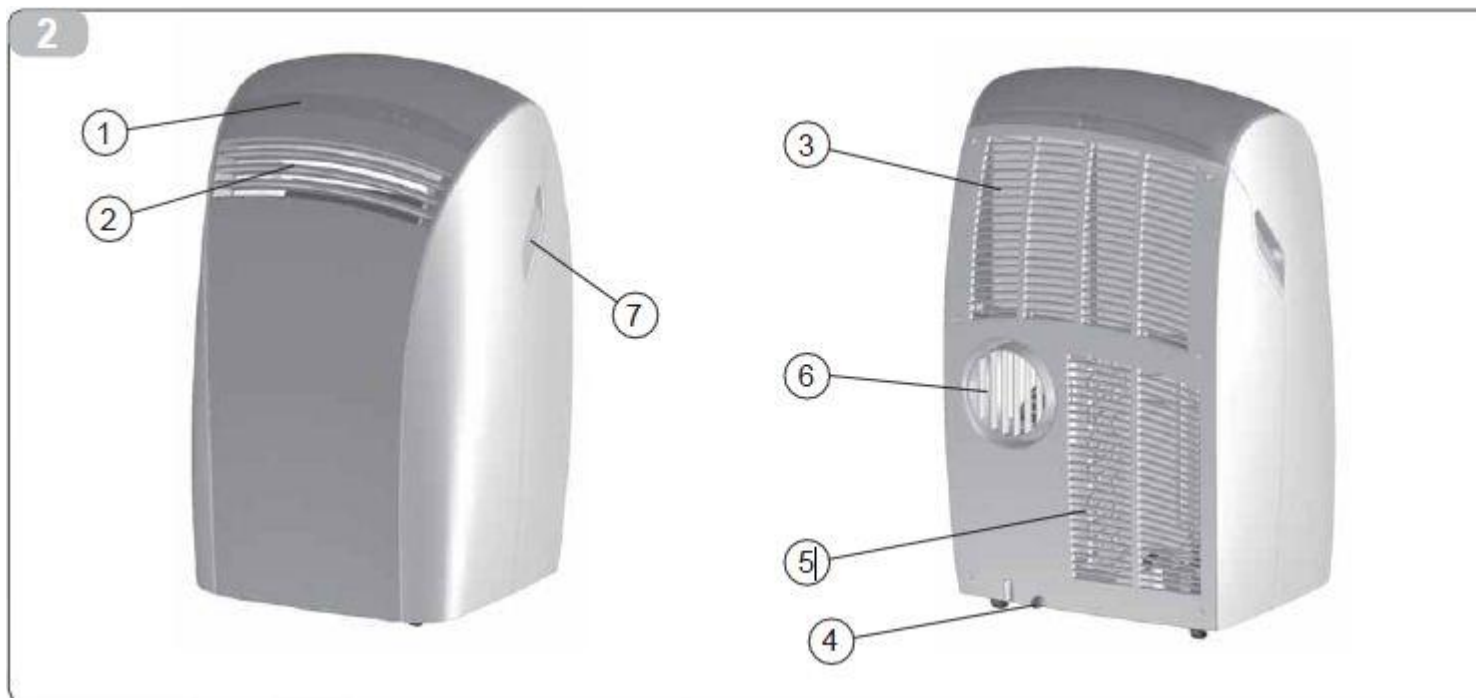

1. Control panel	2. Air outlet grille	3. Air filter grille	4. Drain plug	5. Outdoor air inlet
6. Outdoor exhaust	7. Handle			

**Incorrect Assembly:**

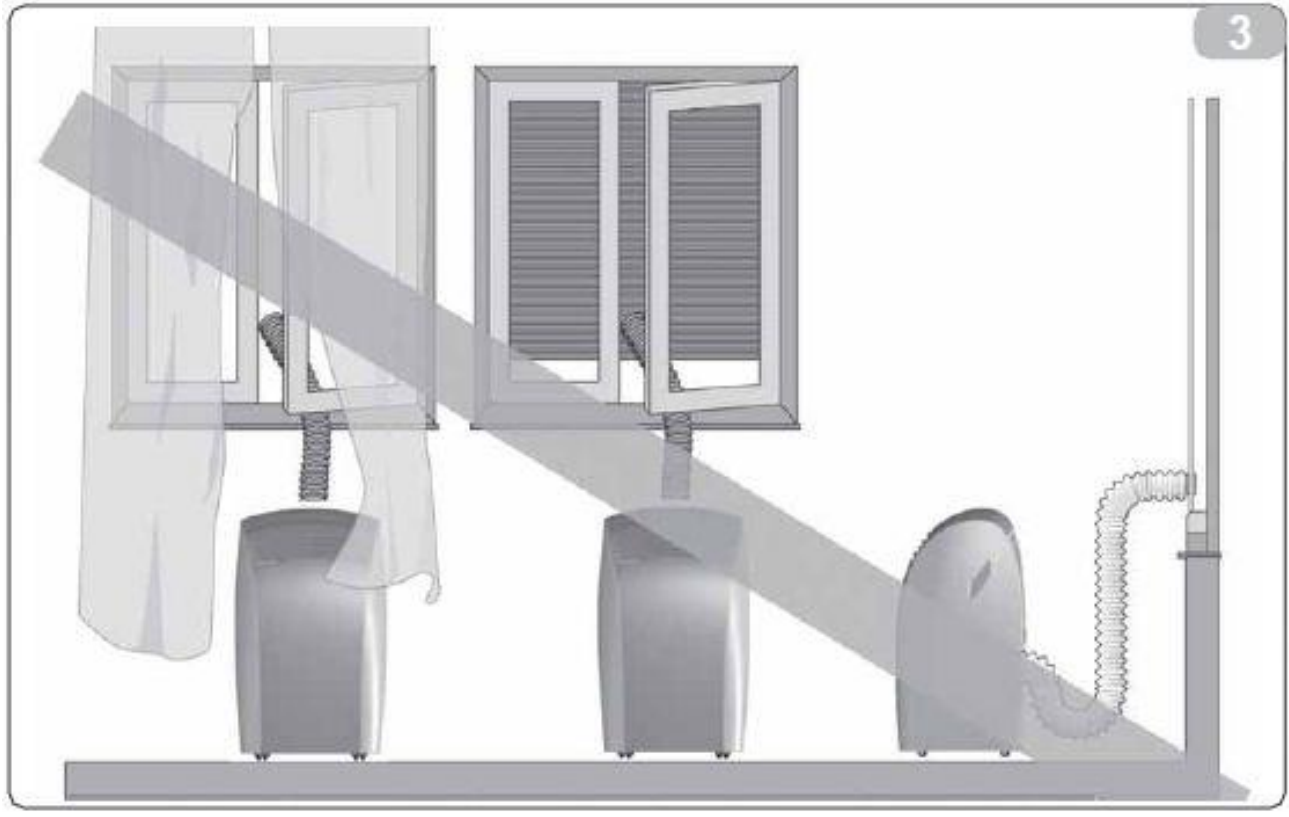

**Correct Assembly:**



Ensure curtains or other objects are not obstructing the air inlet filters. (Fig 3)

Do not bend or crush the exhaust hose while in use. (Fig.3)



## **SAFETY PRECAUTIONS**

---

- Ensure curtains or other objects are not obstructing the air inlet filters.
- Do not bend or crush the exhaust hose while in use.
- Transport the unit in an upright position only, or leave it in an upright position for at least 2 hours before first use.
- Always place the unit on even and hard and level surface.
- The power cord is UL listed. It has a built-in L.C.D.I. (leakage, current, detection, interruption) circuit breaker for added safety. If the power supply is interrupted, press the reset button to reconnect the unit to power source.
- Make sure this unit is connected to a correctly grounded power supply outlet. Do not use an extension cord or power strip.
- Do not under any circumstances cut or remove the third (ground) prong from the power cord.
- Do not turn this unit on and off by plugging and unplugging. Always use the ON/OFF switch.
- Do not sit or place objects on the unit.
- Always allow air flow around the portable air conditioner for at least 20'. Do not use this unit inside closets, cabinets and/or cramped spaces between furniture.
- To avoid the risk of shock, the product should never be used in bathrooms, shower rooms, or in any other steamy or wet areas.
- Do not operate this unit without the air filter.
- Do you use harsh chemicals to clean the filter. Dry thoroughly before inserting the filter into the unit
- This unit is optimized to operate in an ambient temperature of 64°F – 100°F.
- Do not repair, disassemble and/or modify the unit by yourself.
- An opening in a window or wall is required to accommodate the exhaust hose (window kit supplied) to exhaust the hot air from the back of the unit.
- Do not add extra length to the exhaust hose by more than a total length of 9'. This will reduce the cooling efficiency of the portable air conditioner.
- Always turn off the portable air conditioner when cleaning the air filter, and transporting.
- At the end of each season, all water must be drained from the unit and filter must be cleaned before storage.
- Do not use an excessively wet cloth, industrial solvents, oil-based products to clean this portable air conditioner.
- Do not allow children to climb, stand or hang on the outside of the dispenser. The air conditioner could tip over and get damaged and seriously injure somebody.
- Do not store or use gasoline or other flammable vapors and liquids in the vicinity of this or any other appliances.

THE MANUFACTURER DISCLAIMS ANY RESPONSIBILITY IF THE ABOVE INSTRUCTIONS ARE NOT FOLLOWED.

## INSTALLATION

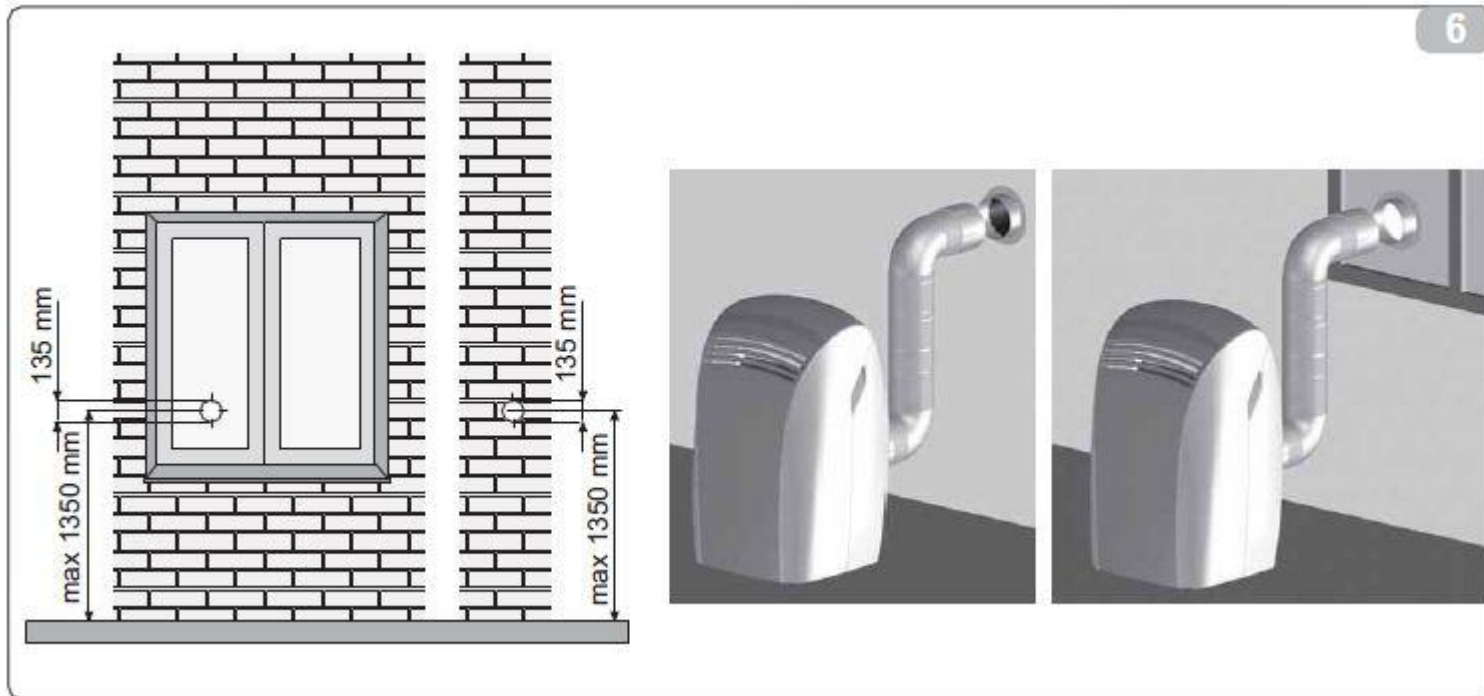

When you use this air conditioner unit, hot air must be exhausted out of the room to complete the air exchange of the condenser. When the unit is operating in fan-only mode, no exhaust is required.

### Exhaust hose Installation

The exhaust hose must be installed onto the unit.

1. Pull out about 6" of one end of the exhaust hose.
2. Screw the exhaust connector on the exhaust hose in a clockwise motion.
3. Snap the exhaust connector in place in the back of the unit.
4. Only extend the exhaust hose to the necessary length. The unit includes a 5' exhaust hose. We do not recommend extending the exhaust hose more than 9' long. If you are interested in purchasing an additional 5' exhaust hose please contact [info@whynter.com](mailto:info@whynter.com) for retail sales information.

**Window Installation**

1. Make sure the exhaust hose is properly installed onto the portable air conditioner.
2. Open window or sliding door for approximately 5" (130 mm)
3. Adjust the length of the window kit to the same length and width of the opening of the window or the sliding door. Cut the window piece if necessary to fit the length of your window or sliding door.
4. Place the window kit on your window or sliding door, with the exhaust hole as near to the portable air conditioner as possible.
5. Close the window or sliding door, on the window kit. For long term installation, you may screw the window kit into your window frame.
6. Adjust the length of the exhaust hose and mount the window kit adaptor to the window kit.

NOTE: When using the window kit on a window or sliding door it will cause the window or sliding door not to be properly closed and locked. Additional security measurements maybe needed.



## CONTROL PANEL

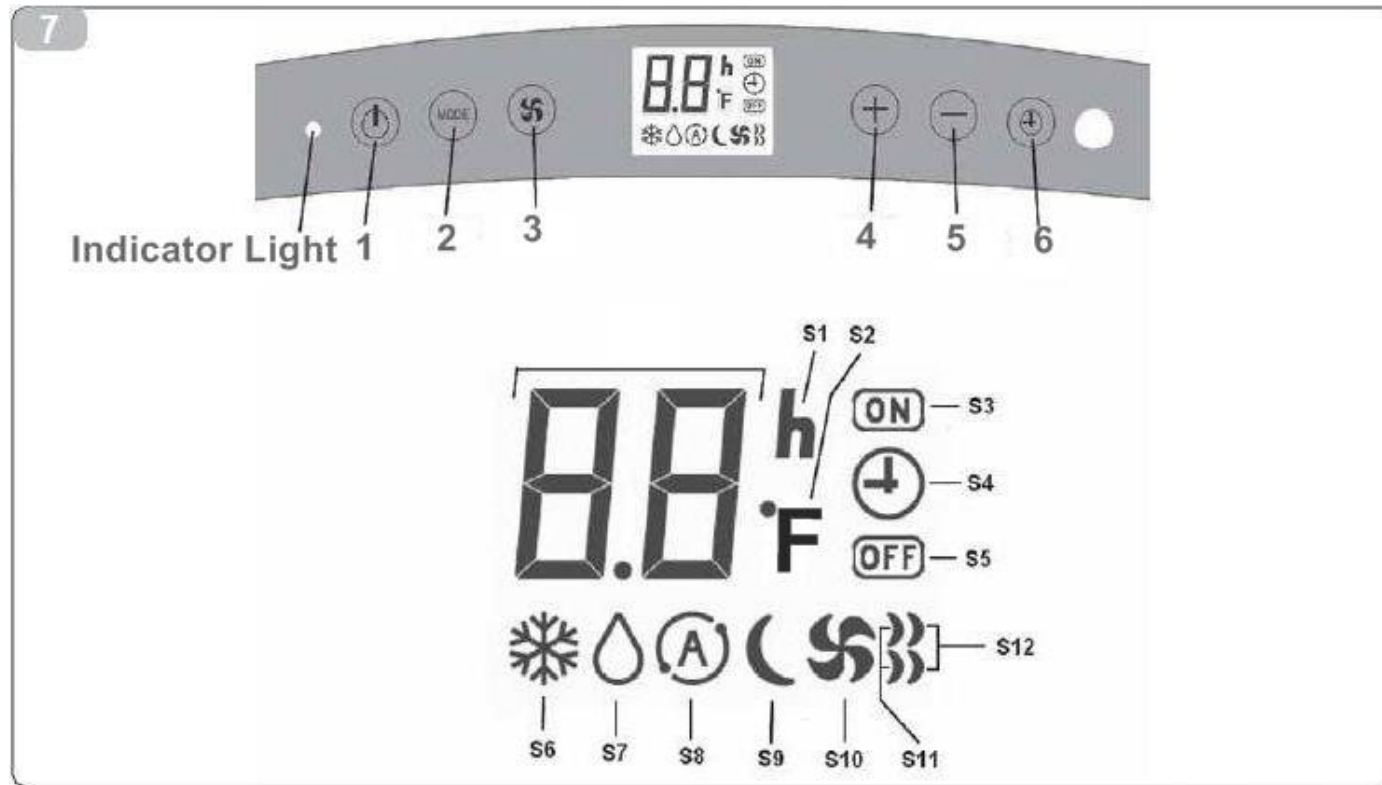

Indicator Light: Standby mode LED (red).		
1: Power – Turns the unit on and off.	2: Mode Control – Controls the 4 function modes: Cooling, Automatic, Fan only & Dehumidification.	3: Fan Speed Control – Controls the 3 fan speeds: High, Medium, Low.
4: Plus – Increases set temperature or timer hours.	5: Minus – Decreases set temperature or timer hours.	6: Timer – Turns the timer function on and off.
S1: Timer indicator	S2: Temperature indicator	S3: Delayed function ON indicator
S4: Timer function indicator	S5: Delayed function OFF indicator	S6: Cooling mode
S7: Dehumidifying mode	S8: Automatic mode	S9: Sleep mode
S10: Fan only mode	S11: Medium fan speed	S12: High fan speed

# OPERATIONS

---

## SWITCHING ON THE AIR CONDITIONER

The portable air conditioner can be switched on by the remote control or by pressing the Power button on the control panel. To transmit signals from the remote control to the air conditioner, point the front part of the remote handset towards the control panel on the air conditioner. Reception of the signal is confirmed by a beep. The maximum signal transmission distance is approximately 8 meters / 26 feet.

### NOTE:

- Other appliances in the same room controlled by a remote control (TV, radio, stereo, etc.), may cause interferences.
- Electronic and fluorescent lamps may interfere with the signal transmissions between the remote control and the air conditioner.
- Remove the batteries if the remote control is not used for long periods.

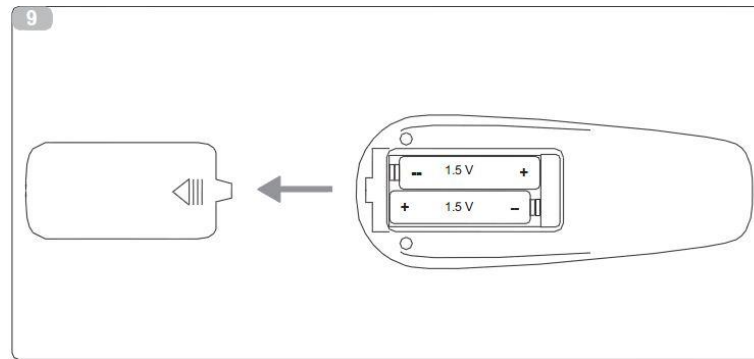

## INSTALLING BATTERIES

- Only use two dry LR03 AAA 1.5V Batteries (included) in the remote control.
- Always change both batteries at the same time.
- To insert the batteries, open the flap on the back of the remote control. Strictly adhere to the polarity signs on the bottom of the battery housing, close the flap once the batteries have been inserted.

## REMOTE CONTROL

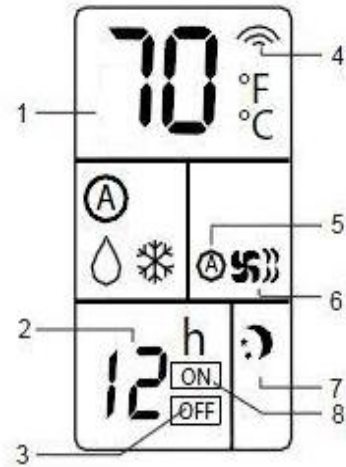
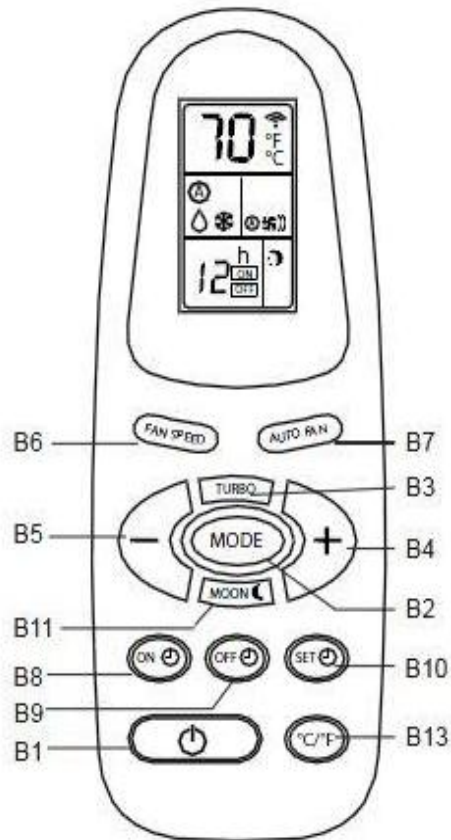

BUTTONS	DISPLAY
B1: POWER – Turns the unit on and off.	1: Set temperature
B2: MODE – Controls the 4 function modes: Cooling, Automatic, Fan only & Dehumidification.	2: Delay time setting
B3: TUBRO – Turns the unit on Cooling mode, lowest temperature (61°F) and maximum fan speed.	3. Delayed switch OFF
B4: Plus – Increases set temperature or timer hours.	4. Remote control signal strength
B5: Minus – Decreases set temperature or timer hours.	5. Auto fan speed mode
B6: FAN SPEED - Controls the 3 fan speeds: High, Medium, Low.	6. Fan speed
B7: AUTO FAN – Turns the unit on auto fan speed.	7. Sleep mode
B8: Unit switch ON delay setting	8. Delayed switch ON
B9: Unit switch OFF delay setting	
B10: Unit switch ON/OFF setting confirmation	
B11: Sleep mode – Turns sleep mode on and off.	
B13: °C / °F – Changes temperature display from Celsius to Fahrenheit.	

## SWITCHING ON/OFF THE AIR CONDITIONER

The appliance can be switched ON or OFF by pressing the Power button (1) on the control panel or the Power button (B1) on the remote control.

### FAN ONLY MODE

In this mode, only the fan of the air conditioner runs and circulates the air in the room. To activate this function mode, press the MODE button (B2 on remote control or 2 on control panel) until fan only symbol () appears on the displays. In this function mode, the temperature cannot be set. Subsequently, set the desired fan speed by pressing the FAN SPEED button (B6 on remote control or 3 on control panel).

Below are the fan speed symbols displayed:

 High FAN    Medium FAN    Low FAN

Please note that when switching function mode, there will be an approximately 3 minutes transition time.

### COOLING MODE

In this mode, the air conditioner cools and dehumidifies the room. To activate this function mode, press the MODE button (B2 on remote control or 2 on control panel) until the cooling () symbol appears on the displays. When the cooling mode is set, the compressor will start in approximately 3 minutes. In cooling mode, hot air is exhausted from the outdoor exhaust port and the exhaust hose must be connected to exhaust out the hot air.

The temperature setting range of this air conditioner is from 61°F to 86°F. To set the temperature, press the (+) or (-) buttons (B4/B5 on remote control or 4/5 on control panel). This air conditioner has a 5°F temperature cushion which if the set temperature is within 5°F of the ambient temperature, the unit runs on fan only mode. This saves energy and prolongs the life of the compressor of the air conditioner.

To set the fan speed, please refer to the FAN ONLY MODE section. In cooling mode, the difference in noise level between the 3 fan speeds is not very noticeable when the compressor is on. Try setting the unit to Fan only mode, you should be able to hear the difference between high and low fan speed settings.

### DEHUMIDIFYING ONLY MODE

In this mode, the air conditioner only dehumidifies the room, the compressor will activate intermittently depending on the ambient temperature and the fan speed is set to LOW. To activate this function mode, press the MODE button (B2 on remote control or 2 on control panel) until the () symbol appears on the displays. Please note that when switching function mode, there will be an approximately 3 minute transition time. In dehumidifying mode, do not connect the exhaust hose and let the warm air return to the room.

### SLEEP MODE

In this mode, the air conditioner gradually increases the set temperature in cooling mode, decreases the noise level and conserves energy. In Sleep & cooling mode, the set temperature is maintained for 1 hour. In the next 2 hours, the temperature is gradually increased by 1°F per hour. After the second hour, the set temperature remains the same.

To activate this function mode, press the MOON button (B11 on remote control only) until the sleep () symbol appears on the display. The fan speed is set to LOW and cannot be changed.

The Sleep mode can be cancelled by pressing the B11 button on remote control.

### **AUTOMATIC MODE**

In this mode, the air conditioner is set to run at the optimum comfort temperature. When the Automatic (comfort) mode is selected, the cooling function stops when the temperature is below 73°F. The cooling function and low fan speed starts when temperature is between 73°F - 77°F. Cooling function and medium fan speed starts when temperature is between 77°F - 81°F. Cooling function and high fan speed starts when temperature is above 81°F. To activate this function mode, press the MODE button (B2 on remote control or 2 on control panel) until  symbol appears on the displays.



### **TURBO MODE**

In this mode, the air conditioner is set to run at the lowest temperature 61°F and high fan speed. To activate this function mode, press the TURBO button (B3 on remote control only).



### **TIMER (DELAYED SWITCH ON / OFF) FUNCTION**

This function mode enables a delayed switch ON or delayed switch OFF of the air conditioner. The time (hours) delay can be set, enabled and disabled from both the remote control and the control panel.



#### **SETTING DELAYED SWITCH ON TIMER FROM REMOTE CONTROL**

Switch on the air conditioner, select the function mode (cooling/ fan only / dehumidifying only), set temperature and fan speed. Then switch off the unit. To activate the delayed switch on function, press the ON timer button (B8 on remote control) and set the desired time delay ON hours (from 1 to 12 hours) by pressing the ON timer button. Once the delayed switch on timer is set, press the SET timer button (B10 on remote control) to confirm the setting. The  symbol and the delay countdown timer will appear on the remote control display. When the delay time set has elapsed, the air conditioner switches on with last selected settings. To cancel the delayed switch on function, press B10 until  symbol disappears on the display.

#### **SETTING SWITCH ON TIMER FROM CONTROL PANEL**

Switch on the air conditioner, select the function mode (cooling/ fan only / dehumidifying only), set temperature and fan speed. Then switch off the unit. Press the Timer button (6 on control panel) and set the desired time delay ON hours (from 1 to 12 hours) by pressing the + and - buttons. Once the delayed switch on timer is set, press the Timer button (6 on control panel) to confirm the setting. The  symbol and the delay countdown timer will appear on the control panel display. When the delay time set has elapsed, the air conditioner switches on with last selected settings. To cancel the delayed switch on function, press Timer button until  symbol disappears on the display.

#### **SETTING SWITCH OFF TIMER FROM REMOTE CONTROL**

With the air conditioner operating in any function mode, press the OFF timer button (B9 on remote control) then set the desired time delay OFF hours (from 1 to 12 hours) by pressing the OFF timer button. Once the delayed switch off timer is set, press the SET timer button (B10 on remote control) to confirm the setting. The  symbol and the delay countdown timer will appear on the remote control display. When the delay time set has elapsed, the air conditioner switches off. To cancel the delayed switch off function, press B10 until  symbol disappears on the display.

**SETTING SWITCH OFF TIMER FROM CONTROL PANEL**

With the air conditioner operating in any function mode, press the Timer button (6 on control panel) and set the desired time delay OFF hours (from 1 to 12 hours) by pressing the + and – buttons. Once the delayed switch off timer is set, press the Timer button (6 on control panel) to confirm the setting. The **OFF** symbol and the delay countdown timer will appear on the control panel display. When the delay time set has elapsed, the air conditioner switches off. To cancel the delayed switch off function, press Timer button until **OFF** symbol disappears on the display.

**CELSIUS / FAHRENHEIT TEMPERATURE DISPLAY**

Press °C/°F button (B13 on the remote control) to change the temperature measurement unit on the remote control display from FAHRENHEIT (°F) to CELSIUS (°C) or vice-versa.

**AUTO RESTART**

In the event of a power outage, the air conditioner restarts at the previously set function mode and settings when power is restored.

## ***TRANSPORTATION***

---

The air conditioner is equipped with wheels and handles for easy portability. Before moving the air conditioner, proceed as follows:

- Switch off the air conditioner and disconnect the plug from the power outlet
- Drain water by removing the drain plug.
- Always transport the air conditioner in an upright position only.

## ***MAINTENANCE***

---



### **CLEANING THE AIR FILTER**

To ensure the air intake is filtered properly and to assure that your air conditioner runs efficiently, it is crucial to clean the air filters regularly. The Fi alarm on the display indicates that the air filter needs to be cleaned.

To clean the air filter:

- Switch off the air conditioner and pull out the air filter from the unit.
- Use a vacuum cleaner or tap lightly to remove loose dust and dirt from the filter. Then rinse it thoroughly under warm or cold running water (no hotter than 100F.)
- Dry thoroughly before re-inserting the filter.



**WARNING! Never operate the air conditioner without the filter in place.**

**DRAINING THE AIR CONDITIONER**

- ALWAYS switch off the air conditioner and disconnect the plug from the power supply outlet before cleaning the air conditioner.
- Position a flat container or dish under the drain hole. Do not allow the water to drip continuously into the container, as it might easily overflow.
- Remove the drain stopper from the drain hole. The condensed water will drain out automatically.
- When the container is almost full, insert the drain stopper back to the unit. Empty the container.
- Repeat steps 2, 3 & 4 until all the condensed water is emptied. You may also want to tilt the air conditioner backwards to drain out all the condensed water.
- Once all the condensed water has been removed, insert the drain stopper into the drain hole firmly.

**CLEANING THE AIR CONDITIONER**

- Always switch off the air conditioner and disconnect the plug from the power supply outlet before cleaning the air conditioner.
- Use a soft damp cloth to wipe the body of the air conditioner.
- Never use harsh chemicals, oil-based products, detergents, chemically treated cloths or other cleaning solutions. These could possibly damage the body of the air conditioner.

**END OF SEASON STORAGE**

- Switch off the air conditioner and disconnect the plug from the power supply outlet before cleaning the air conditioner.
- Clean the air filter.
- Drain the condensed water COMPLETELY.
- On a warm day, turn on the Fan only mode for a couple of hours so that the inside can dry out completely.
- It is recommended that the air conditioner be put back into its original carton for storage.
- Do not stack heavy objects on top of the air conditioner.
- Make sure to store the remote control with the air conditioner.



# ***TROUBLESHOOTING***

<b>Problem</b>	<b>Possible Causes</b>	<b>Solutions</b>
The portable air conditioner does not turn on	<p>Power failure / outage.</p> <p>The automatic switch, line fuse, or breaker has been tripped.</p> <p>The power supply voltage is too low.</p> <p>The power cord is damaged.</p> <p>The L.C.D.I. power plug for the unit is tripped.</p> <p>The internal water reservoir is full.</p>	<p>Restore the power supply.</p> <p>Flip the switch / change the fuse / turn the breaker back on. Also note that you may have too many appliances drawing power on one circuit, you may need to move the other appliances to another circuit.</p> <p>Move the unit onto another circuit with the correct voltage.</p> <p>Call for service. Only authorized personnel should replace damaged power cord or power plug.</p> <p>Press the Reset button on the L.C.D.I. power plug.</p> <p>Manually drain the water by removing the drain plug.</p>
The unit turns on but the compressor does not turn on (the fan runs but the unit is not cooling)	<p>The room temperature is outside of the operational tolerances of the unit.</p> <p>The Cooling mode is not on.</p> <p>The compressor has not turned on yet because of its time delay.</p> <p>The set temperature is too high.</p> <p>The internal water reservoir is full.</p> <p>The unit is set to Automatic (Comfort) mode.</p>	<p>This unit is designed to work in ambient temperatures of 61°F to 100°F.</p> <p>Press the MODE button until the Cooling icon is shown on the display.</p> <p>Give the compressor 3 minutes to turn on after the Cooling mode has been selected.</p> <p>Set the air conditioner to a lower temperature. It is recommended to set the temperature to at least 5°F of the ambient temperature.</p> <p>Either manually drain the water by removing the drain plug or allow the unit to exhaust the water itself by running the fan only mode. Then cooling will resume.</p> <p>Cancel the automatic function mode and manually set the temperature to at least 5°F below the ambient temperature.</p>
The air coming out of the unit is not very cold, or the airflow volume is weak	<p>The filter is dirty or obstructed.</p> <p>The air intake or exhaust is obstructed.</p> <p>The unit is set in dehumidifying or fan mode.</p>	<p>Clean the air filter.</p> <p>Make sure there is at least 20" of clearance from the air intake. Make the length of the exhaust hose is as short as possible.</p> <p>Set the unit to the cooling mode.</p>

	The unit is set to low fan speed.	Set the unit to a higher fan speed.
The unit has worked for a long time, but the room is not cold enough	<p>Windows or doors are open.</p> <p>There are too many people in the room.</p> <p>There is direct sunshine into the room.</p> <p>The room is a kitchen or with many heat-producing appliances</p> <p>There is a server in the room.</p> <p>The room is too large.</p>	<p>Close all windows and doors.</p> <p>You may need additional cooling or another air conditioner.</p> <p>Close curtains or blinds and try to minimize the amount of direct sunlight into the room.</p> <p>You may need additional cooling or another air conditioner.</p> <p>You may need additional cooling or another air conditioner.</p> <p>You may need additional cooling or another air conditioner.</p>
The unit is very noisy	<p>The unit is not level.</p> <p>The surface underneath the unit is uneven.</p> <p>Low power voltage.</p>	<p>Make sure the unit is on hard, level and stable surface.</p> <p>Move the unit to a location with a level and hard floor.</p> <p>Make sure the wall outlet and support the required power consumption of the air conditioner and do not use an extension cord.</p>
The unit leaks water	<p>The unit is tilted or not leveled</p> <p>The water tank is full.</p>	<p>Make use the unit is leveled.</p> <p>Drain water from the drain plug at the back of the air conditioner.</p>
Fan speed cannot be changed	Fan speed differences are not very noticeable	The fan speed difference is not very noticeable when the compressor is on. Try setting the unit to Fan only mode, you should be able to hear the difference between high and low fan speed settings.

## **TECHNICAL DATA**

---

Cooling capacity	13,000 BTU
Recommended room size*	450 – 500 sq. ft.
E.E.R. – Energy efficiency rate	11.06
Power supply	115v/ 60Hz
Maximum power input	910 Watts
Maximum input	8.20 Amps
Dehumidifying capacity	43 Pts / Day
Thermostat	61°F to 86°F / 16°C to 32°C
Refrigerant	R-410A
Compressor	Rotary
Air flow (max)	380 m3/ Hour
Fan speeds	3 (H, M, L)
Exhaust hose length	5 ft.
Unit Dimensions	18" W x 15.5" D x 30" H
Unit Weight	66 lbs

## **ONE YEAR LIMITED WARRANTY & THREE YEAR WARRANTY ON COMPRESSOR**

This WHYNTER portable air conditioner is warranted, to the original owner within the 48 continental states, for one year from the date of purchase against defects in material and workmanship under normal use and service. Should your WHYNTER portable air conditioner prove defective within one year from the date of purchase, return the defective part or unit, freight prepaid (within two months of purchase; after two months to one year, customer will be responsible for freight cost to Whynter's service department), along with an explanation of the claim to Whynter LLC. Please package the portable air conditioner carefully in its original packaging material to avoid damage in transit. Please retain the original box and packaging material. Under this warranty, Whynter will repair or replace any parts found defective. This warranty is not transferable. After the expiration of the warranty, the cost of labor and parts will be the responsibility of the original owner of the unit.

### THIS WARRANTY DOES NOT COVER:

- Acts of God, such as fire, flood, hurricanes, earthquakes and tornadoes.
- Damage, accidental or otherwise, to the air conditioner while in the possession of a consumer not caused by a defect in material or workmanship;
- Damage caused by consumer misuse, tampering, or failure to follow the care and special handling provisions in the instructions.
- Damage to the finish of the case, or other appearance parts caused by wear.
- Damage caused by repairs or alterations to the air conditioner by anyone other than authorized by the manufacturer.
- Freight and Insurance cost for the warranty service.

To obtain service or information, contact  
Whynter LLC via Email at [service@whynter.com](mailto:service@whynter.com) or call 866-WHYNTER.