

# YARDISTRY STRUCTURES- COLLECTION SERIES CS002

YM11522

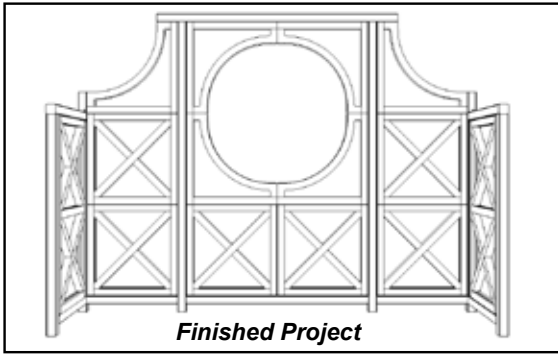

1. Assemble panel in configuration shown. (Fig. 1) Secure panels with 2 1/4" screws provided in the direction and location of the arrows. Use pre-drilled holes when available. **\*Ensure Panels are oriented correctly! (Fig. A)**

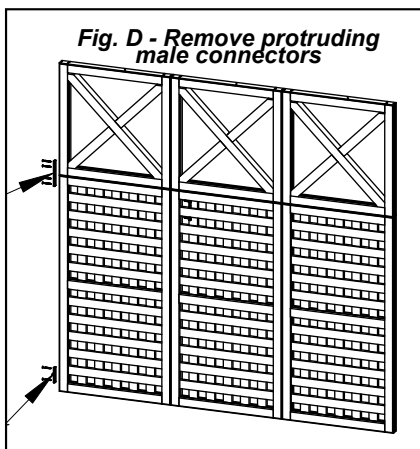
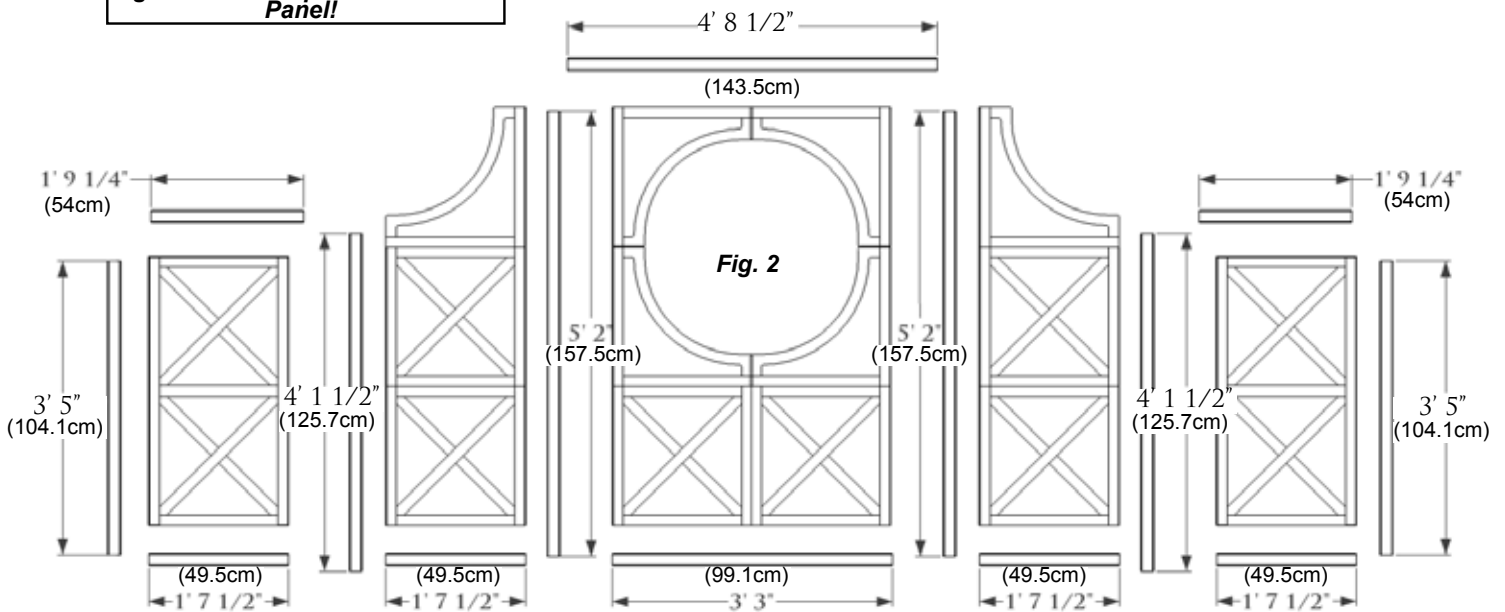
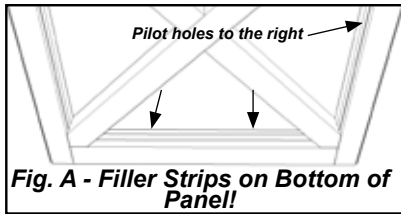
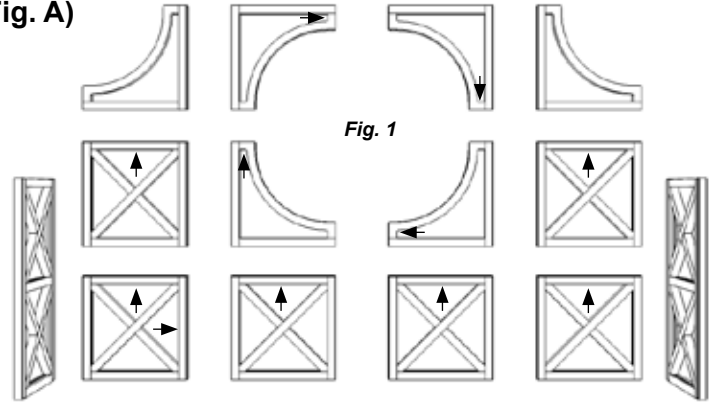

2. Cut Posts and Rails to size indicated in Fig. 2. (It is recommended to use a Mitre Box or Mitre Saw)
3. Attach Post and Rails to panels with 2 1/4" screws in locations indicated by **circles** using pre-drilled holes where available. (Fig.3) When pre-drilled holes are not available use a 1/8" Drill Bit to drill holes on an angle in the inside of the panel as shown. (Fig. F)
4. Remove protruding male connectors to ensure flush connection with 2x2 posts in later steps. (Fig. D)

6 x One High X Topper | 2 x Two High X Panel | 6 x Arch Topper | 10 x -2"x2"x62" Post/Rail

**Center the Panels on Posts and Rails before attaching!**

5. Using a 1/8" drill bit, pre-drill Post and Rails in locations indicated by the **arrows** and attach to side posts using 2 3/4" screws. (Fig.3)

**\*If you purchased the Post Stake to secure your project, please refer to the instructions provided with the post stake to anchor your project to the ground.**

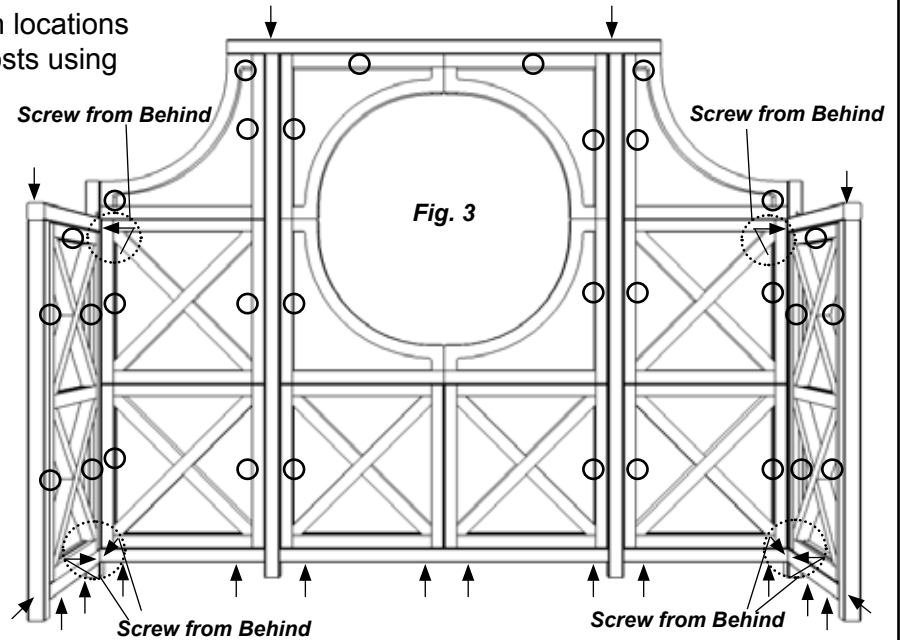
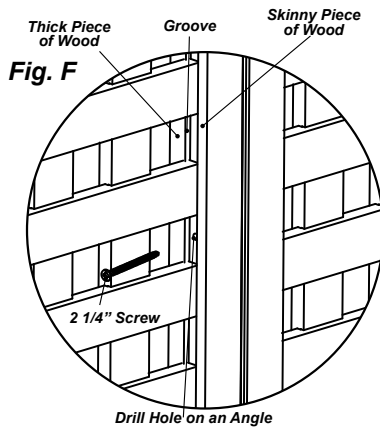

### **!Important Safety Notice!**

- Yardistry components are intended for privacy, decorative and ornamental use only. **Product is NOT INTENDED for the following:**
  - A safety barrier to prevent unsupervised access to pools, hot tubs, spas, or ponds.
  - Safety railings for elevated platforms or decks.
  - As load bearing support for a building, structure, heavy objects or swings. - Used in structures that trap wind, rain or snow that would create extra load on the product.
- **Permanent structures may require a building permit.** As the purchaser and or installer of this product you are advised to consult local planning, zoning, and building inspection departments for guidance on applicable building codes and or zoning requirements.
- **Wood is NOT flame retardant and will burn.** Grills, fire pits and chimneys are a fire hazard if placed too close to a Yardistry structure. Consult user's manual of the grill, fire pit or chimney for safe distances from combustible materials.
- **During installation, follow all safety warnings provided with your tools and use OSHA approved safety glasses.**
- **Some structures may require two or more people to install safely. Check for underground utilities before digging or driving stakes into the ground!**

**General Information:** Wood components are manufactured with Cedar (C. Lanceolata) which is protected with factory applied water-based stain. Knots, small checks (cracks) and weathering are naturally occurring and do not affect the strength of the product. Annual application of a water-based water repellent sealant or stain will help reduce weathering and checks.

**Warranty:** Yardistry Limited products are backed by a 5 year limited lifetime warranty from the date of original retail purchase for manufacturing defects and if installed as per manufacturer's installation instructions.

Patents Pending

[www.YardistryStructures.com](http://www.YardistryStructures.com)