

Outlets available on this generator, from left to right:
120V AC, 240/120 AC and 12V DC.

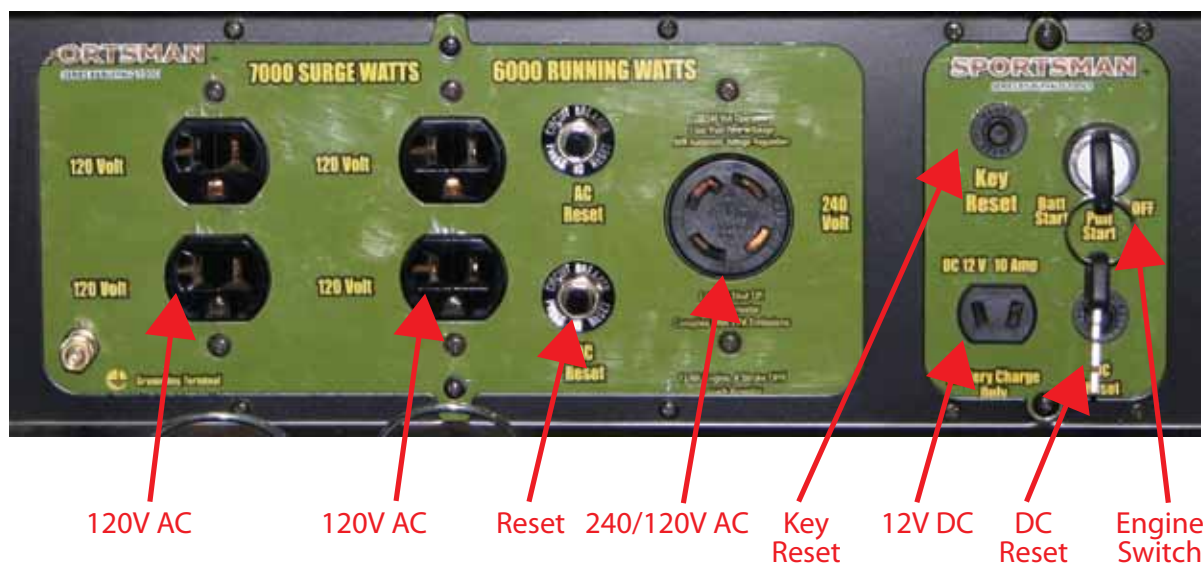

GEN7000

7,000 Surge / 6,000 Running Watts

! DANGER

SEEK THE ADVICE OF A LICENSED ELECTRICIAN FOR 120V / 240V WIRING

Enlarged View Of 120/240 Volt Outlet

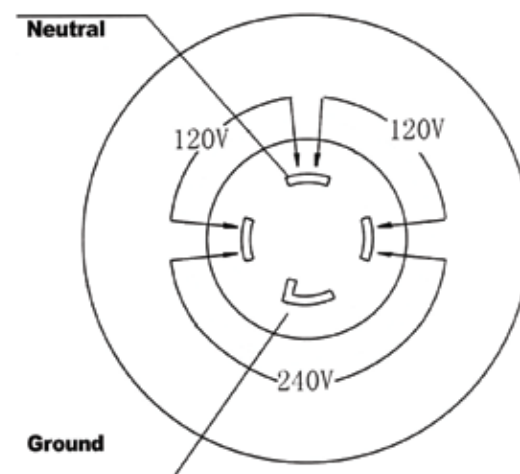

WARNING: According to the State of California, the exhaust from this generator contains chemicals known to cause cancer, birth defects, or other reproductive harm.

WARNING

IF THERE IS ANY QUESTION ABOUT A CONDITION BEING SAFE OR UNSAFE, DO NOT OPERATE THIS PRODUCT!

Always follow Warning labels placed on the generator, and read and follow all Warning labels included inside the Product Manual.

WARNING: NEVER use a generator inside a home or a garage, EVEN IF the doors and windows are open.

ONLY USE OUTSIDE and far way from windows, doors and vents leading into an enclosed area.

Using a generator indoors can kill you in minutes. The generator produces an exhaust that contains carbon monoxide. This is a poison you cannot see or smell.

Do not attach a chain or rope to secure the generator to a post as this can be difficult to remove in the event of an emergency.

DO NOT CONNECT electrical devices until AFTER the generator is started.

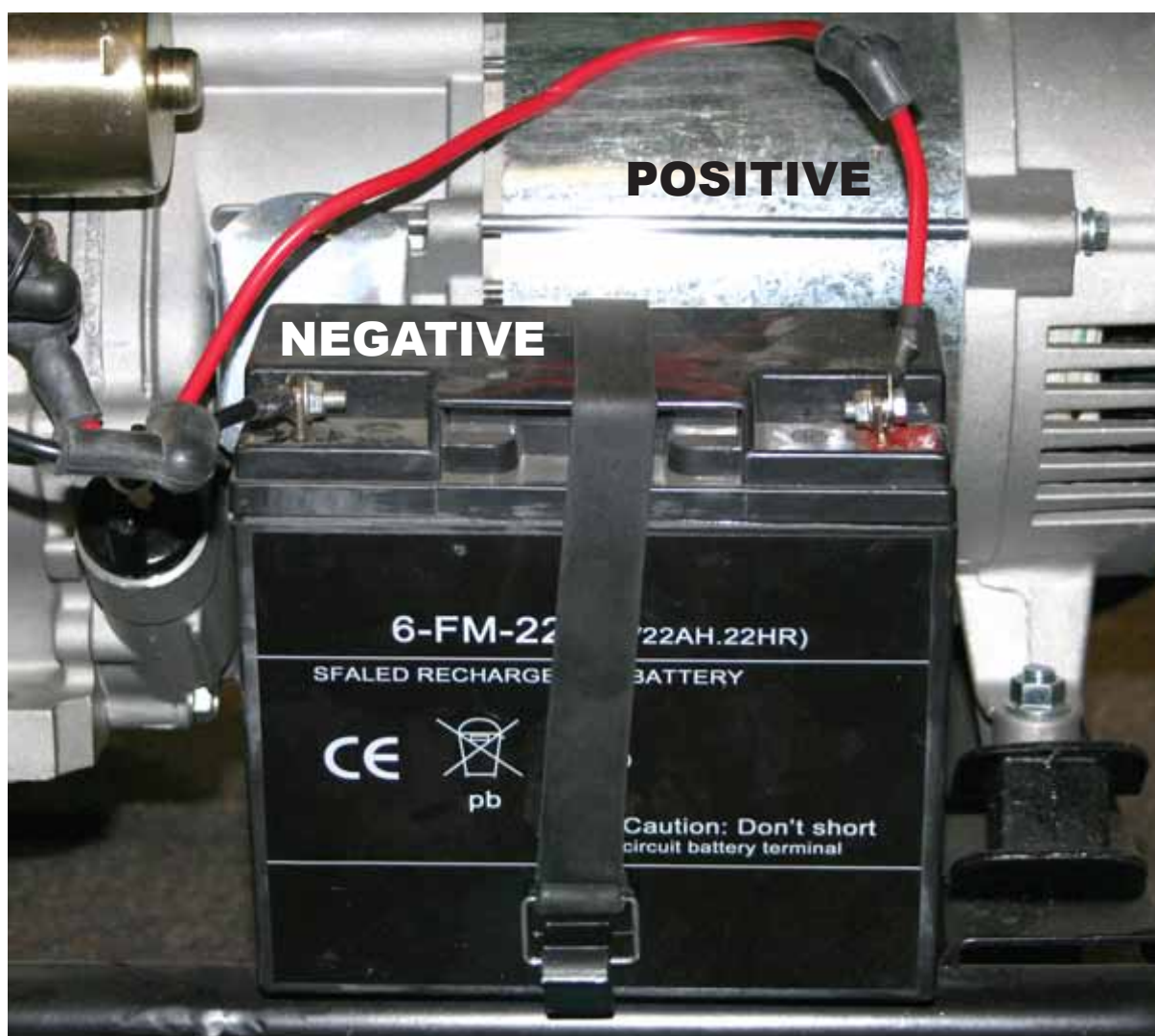

Battery Installation

A battery must be installed before the electric start feature can be used. Disconnect all electrical loads from this generator before installing/changing the battery.

Mount the battery tray to the generator frame. Insert the bolts (M6x12) through the frame and tighten.

Take the red (positive) cable from the engine and attach it to the positive terminal on the battery.

Take the black (negative) cable from the engine and attach it to the negative terminal on the battery.

Use the enclosed rubber strap to secure the battery in place.

TOLL-FREE NATIONWIDE HELP LINE! 866-460-9436

Need Help? Do Not Return This Generator To The Store! Call Us First!
Monday-Friday 8:00-4:30 Central Time

Visit our website for Troubleshooting & Frequently Asked Questions

SPORTSMAN
SERIES BY BUFFALO TOOLS

www.sportsmanseriesbrand.com/generators

Follow This Step-By-Step Guide To Using Your Generator

1 Remove generator from package

2 Add Oil

Oil Type: SAE10W-30 Oil (Must add BEFORE first use)
Oil Capacity: 38 fluid oz (1.13 L)
Because this generator includes Low Oil Shut Off, the generator will not start with low oil)

3 Add Fuel

Unleaded gasoline only octane rating of 87 or higher
Maximum Capacity: 7 Gallon fuel tank

4 Start The Generator

- Use the generator OUTDOORS in a WELL VENTILATED AREA.
- DO NOT CONNECT electrical devices until AFTER the generator is started.
- Turn FUEL PETCOCK to ON (Figure A)
- Adjust the CHOKE to CLOSED position (Figure B)
- Start the generator manually with the Recoil (Pull) Start. To use the Electric Start, a battery must be purchased (sold separately).
- Once the engine has started and runs for about a minute, move the choke lever approximately half way towards the "Open/Run" position. Wait an additional 30 seconds and then move the choke lever completely over to the "Open/Run" position.
- You can now connect electrical devices.

GEN7000

7,000 Surge / 6,000 Running Watts

UNLEADED GASOLINE FUEL

A BATTERY IS NOT INCLUDED! TO USE THE ELECTRIC START FEATURE, BUY A BATTERY WITH THESE SPECIFICATIONS:

Dimensions: 7 1/8" L x 6" H x 3" W
CCA (Cold Cranking Amps): 130 Min CCA

Comparable brands/models are:
12 Volt 22 Ah Sealed Lead Acid
Batterymart.com: SLA-12V22 or YB9A-A
Delco: CB9A-A
NAPA: 740-1872, 740-1858, 740-1837
Sears: 44043

GENERATOR SPECIFICATIONS:

- 120/240 Volt Operation
- 13 HP Engine, 4 Stroke OHV
- Air Cooled
- 7 Gallon Fuel Tank w/Gauge
- AVR Automatic Voltage Regulation
- Low Oil Shut Off
- Spark Arrestor
- UL Listed Electrical Components
- Engine Shut Off Switch
- Circuit Breaker & Power Outlets
- 1-12V DC Outlet
- 4-120V Outlets
- 1-120/240V Outlet
- Complies with EPA emissions
- Run time = 12 hours @ 50% load
- Decibel Rating < 80 db
- Mobility Kit: Included
- Warranty: 1 YEAR limited

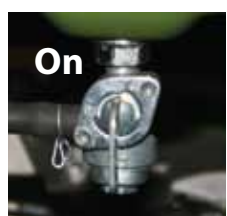

On

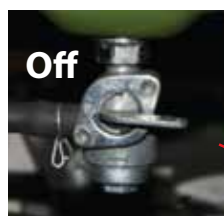

Off

Fuel Petcock (Figure A)

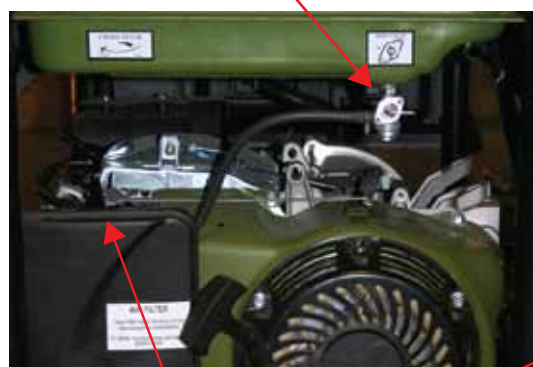

Choke (Figure B)

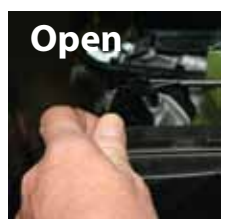

Open

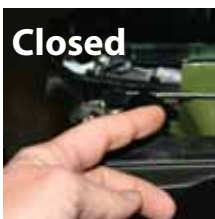

Closed



3 Add Gasoline

4
Recoil Start

2 Add Oil

Battery Tray

4
Key Start

TOLL-FREE NATIONWIDE HELP LINE! 866-460-9436

**Need Help? Do Not Return This Generator To The Store! Call Us First!
Monday-Friday 8:00-4:30 Central Time**

Visit our website for Troubleshooting & Frequently Asked Questions

SPORTSMAN
SERIES BY BUFFALO TOOLS

www.sportsmanseriesbrand.com/generators