

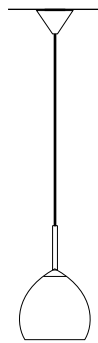



LEUCOS®

INSTRUCTIONS FOR INSTALLATION / LEUCOS USA

GOLF S 3



A1 Enclosed  One installer  Save instructions  Revised 04/10/ 2006

WARNING:

- DISCONNECT POWER BEFORE INSTALLATIONS.
- FIXTURE TO BE INSTALLED BY A CERTIFIED ELECTRICIAN.
- INSTALL IN ACCORDANCE WITH THE NATIONAL AND LOCAL ELECTRICAL CODES.
- FOLLOW DIRECTIONS CAREFULLY IN ORDER TO AVOID SCRATCHING OR DAMAGING THE GLASS DIFFUSER.

1. Fig. 1 Attach the metal canopy "A" to the J-Box and carry out the connections to the supply grid.
2. Fig. 2 Guide the electrical wire through the central hole "D" of the canopy "B".

NOTE: DURING WIRING TAKE CARE TO GUIDE THE LAMP WIRE THROUGH THE PLASTIC CLAMP "X1" AND "X2" AND LOCK IT BY THE SIDE PLASTIC SCREW "G".

3. Connect the fixture's electrical wire to supply wire connectors of the proper size leaving excess wire for decorative "Swag" below canopy.
4. Slide the canopy "B" up to rest against the ceiling and secure it in position with set screw "H".

ATTENTION: IF DURING THE INSERTION YOU SCENT THE GLASS IS NOT CORRECTLY INSERTED, DON'T FORCE ABSOLUTELY BUT CARRY OUT A ROTARY MOTION TILL YOU OBTAIN THE ENTRANCE CORRECTLY.

5. Guide the glass neck into the mounting "T" and fix it through the ring "G".
6. Insert the bulb into the lampholder.
7. Restore the power.







GOLF S3	K max 1x100 - type A-19 
	AL max 1x100 - type A-19 
GOLF S3/N	K max 1x100 - type A-19 
	AL max 1x100 - type A-19 
GOLF S3/NM	K max 1x100 - type A-19 
	AL max 1x100 - type A-19 

FIG.2



For additional information please contact your local dealer or **LEUCOS U.S.A.**
At: Tel. (732) 225-0010 Fax. (732) 225-0250
www.leucos.com

CIRCUIT DIAGRAM:

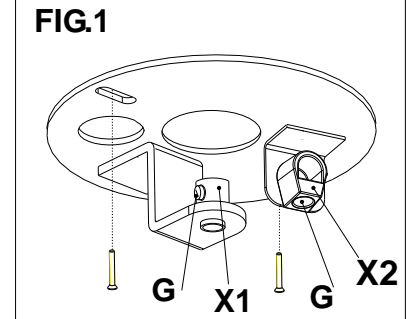
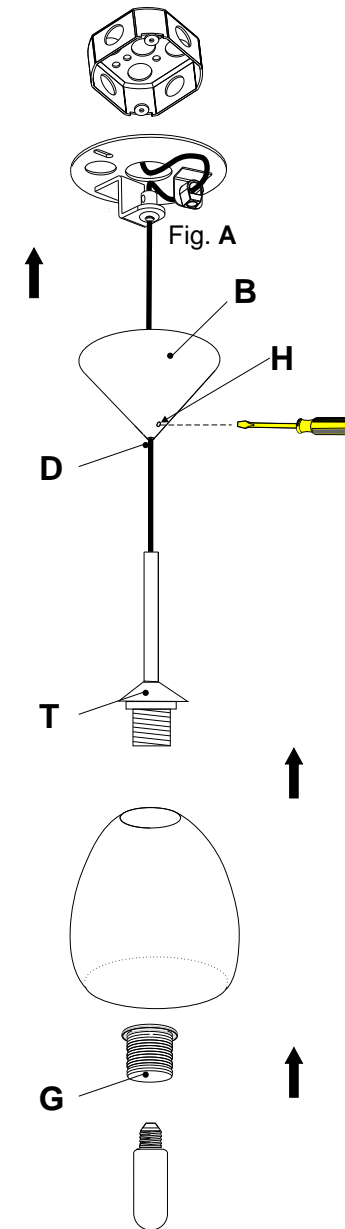
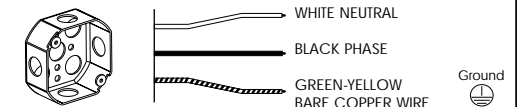

MOUNTS TO STANDARD JUNCTION BOX